



**DOOR ACCESSORIES**

1

**EMTEK**

**EMTEK DOOR KNOCKERS** - Special Order

**Solid Brass**

**2620**

Urn Style

7-1/2" H x

3-13/16" W



Available finishes:  
Polished Brass (US3)  
Oil R Bronze (US10B)  
Satin Nickel (US15)  
Flat Black (US19)

**Bronze**

**86060**

4" Dia.



Available finishes:  
Flat Black Bronze (FB)  
Medium Bronze (MB)  
Tumbled White Bronze (TWB)

Code	Description	List/ea
2620-	Solid Brass, Urn Style	\$ 61
86060-	Bronze, 4" Ring Pull	78

**EMTEK DOOR VIEWER** - Special Order

Solid Brass Door Viewer.  
200° wide viewing angle.  
Fits door thickness from  
1-3/8" to 2". Hole dia: 5/8".

**2610**



Available finishes:  
Pol Brass (Lifetime) - US3  
Satin Brass - US4  
Oil R Bronze - US10B  
Satin Nickel - US15  
Flat Black - US19

Code	Description	List/ea
2610-	Door Viewer	\$ 24

**BALDWIN OBSERV-O-SCOPE**

The exterior lens is constructed of a scientific glass to prohibit scratching while exceeding a 160° field of vision. For door thicknesses: 1.312 to 2.25". Lens diameter: 1/2".



**0155**

Polybagged, 10 each per box.

Code	Finish	List/ea
0155-260	Polished Chrome	\$ 21.02

**EMTEK HOUSE NUMBERS** - Special Order

**7" Modern** - Solid Brass

283



Available finishes:  
Satin Brass (US4)  
Oil R Bronze (US10B)  
Satin Nickel (US15)  
Flat Black (US19)

Add 0-9 House Number at end of product code.

Code	Description	List/ea
283-	7" Modern House Numbers	\$ 36

**EMTEK DOOR BELLS**

Special Order



**2400**



**2465**



**2463**



**2452**

Available in a variety of styles and finishes.

Brass/Wrought Steel Doorbells	List \$ 47
Sandcast/Tuscany Bronze Doorbells	List \$ 53



1

# MAIL PLATES

## **BALDWIN MAGAZINE SIZE PLATE**

Spring Tension Design, Weatherproof



Made of heavy gauge wrought brass.  
Overall: 10" x 3". Inside Opening: 8.25" x 2.375".

Specially designed for use on exposed doors to prevent wind from driving rain and snow through the slot. Bronze spring keeps flap tightly shut & permits vertical installation. A sleeve (0050-324) is available for hollow core doors.

<u>Code</u>	<u>Finish</u>	<u>List/ea</u>
0015-003	Lifetime Pol. Brass	\$ 134.12
0015-056	Lifetime Sat. Nickel	134.12
0015-150*	Satin Nickel	134.12
0015-264*	Dull Chrome	134.12

\*disc when out

## **BALDWIN MAIL PLATE SLEEVES**



Stainless Steel, fits 1.75" thick doors.  
1 set/box with sheet metal screws.

0050= 8.06" L x 2.25" W x 1.69" D  
0052= 11.38" L x 2.75" W x 1.69" D

<u>Code</u>	<u>Fits Mail Plate:</u>	<u>List/ea</u>
0050-324	0015, 0017	\$ 45.04
0052-324	0012, 0014	50.04

## **BALDWIN PACKAGE SIZE PLATE**

Spring Tension Design, Weatherproof



Made of heavy gauge wrought brass.  
Overall: 13" x 3.625". Inside Opening: 11.5" x 2.8".

Large Opening will accommodate catalogs & small packages. Close fit of flap provides weathertight installation. Bronze spring keeps flap tightly shut & permits vertical installation. A sleeve (0052-324) is available for hollow core doors. 1/box with screws.

<u>Code</u>	<u>Finish</u>	<u>List/ea</u>
0012-003	Lifetime Pol. Brass	\$ 146.13
0012-056	Lifetime Sat. Nickel	146.13
0012-050	Satin Brass/Black	146.13
0012-102	Oil R Bronze	146.13
0012-150*	Satin Nickel	146.13
0012-264*	Dull Chrome	146.13

\*disc when out

## **EMTEK MAIL SLOT - Special Order**

Solid Brass

13-1/16" L x  
3-3/8" Height, 5/8" Proj.



**2280**

Complete set includes both exterior and interior trims and wood screws. Available in Polished Brass (US3), Oil R Bronze (US10B), and Satin Nickel (US15).

<u>Code</u>	<u>Description</u>	<u>List/ea</u>
2280-	Solid Brass Mail Slot	\$ 120



## KICKPLATES

## PUSH & PULL PLATES

1

### TRIMCO KICKPLATES

Solid Brass



16 gauge kickplates, eased edges drilled and furnished with stainless steel wood screws, plated to match plate. Individually paper wrapped.

Code	Size	Finish	List/ea
K0050-605-634	6" x 34"	Pol. Brass	119.49
K0050-630-828	8" x 28"	Dull St. Steel	39.05
K0050-613-830	8" x 30"	Oil R. Bronze	192.62
K0050-605-834	8" x 34"	Pol Brass	187.09
K0050-613-834	8" x 34"	Oil R. Bronze	218.31
K0050-630-834	8" x 34"	Dull St. Steel	57.60
K0050-605-840	8" x 40"	Pol. Brass	220.09
K0050-613-840	8" x 40"	Oil R. Bronze	206.89
K0050-613-1028	10" x 28"	Oil R. Bronze	181.02
K0050-630-1028	10" x 28"	Dull St. Steel	59.26
K0050-605-1030	10" x 30"	Pol. Brass	213.46
K0050-613-1030	10" x 30"	Oil R. Bronze	235.57
K0050-630-1030	10" x 30"	Dull St. Steel	63.51
K0050-613-1034	10" x 34"	Oil R. Bronze	258.10
K0050-630-1034	10" x 34"	Dull St. Steel	79.15
K0050-613-1040	10" x 40"	Oil R. Bronze	258.60
K0050-630-1040	10" x 40"	Dull St. Steel	69.70

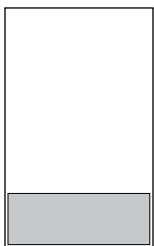

Kick Plate

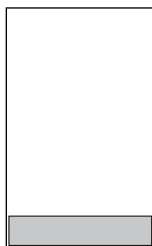

Mop Plate

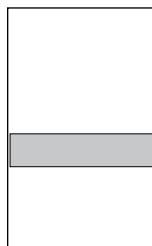

Stretcher Plate

### TRIMCO PULL & PUSH PLATES

Solid Brass

Solid Brass Pull Plates.  
.050 Gauge. One ea/ Ctn.  
C/C of pull: 5"

No.	Size
1010-2	3.5" x 15"
1010-3	4" x 16"

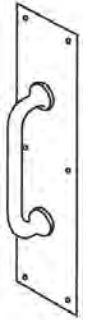

Code	Size	Finish	List/ea
1010-2-613	3.5" x 15"	Oil R. Bronze	\$ 94.66
1010-2-619	3.5" x 15"	Satin Nickel	119.87
1010-2-626	3.5" x 15"	Dull Chrome	90.04
1010-3-613	4" x 16"	Oil R. Bronze	94.65
1010-3-626	4" x 16"	Dull Chrome	94.65

Solid Brass Push Plates.  
.050 Gauge. One ea/ Ctn.

No.	Size
1001-1	3" x 12"
1001-2	3.5" x 15"
1001-3	4" x 16"



Code	Size	Finish	List/ea
1001-1-605	3" x 12"	Pol. Brass	\$ 32.34
1001-1-613	3" x 12"	Oil R. Bronze	34.86
1001-1-619	3" x 12"	Sat. Nickel	41.62
1001-1-630	3" x 12"	Dull Stainless Stl	12.77
1001-2-605	3.5" x 15"	Pol. Brass	\$ 40.26
1001-2-613	3.5" x 15"	Oil R. Bronze	40.53
1001-2-619	3.5" x 15"	Sat. Nickel	51.25
1001-2-626	3.5" x 15"	Dull Chrome	38.80
1001-2-630	3.5" x 15"	Dull Stainless Stl	16.85
1001-3-605	4" x 16"	Pol. Brass	\$ 46.24
1001-3-613	4" x 16"	Oil R. Bronze	48.62
1001-3-626	4" x 16"	Dull Chrome	44.57



1

## LEVER DOOR STOPS

### BALDWIN LEVER TYPE DOOR HOLDER

Forged Brass

**4100** - Length of Arm: 4"

**4105** - Length of Arm: 5"

Stainless steel hinging pin, holder can be operated by foot. Spring catch holds lever upright. 10/box, with wood screws.



<u>Code</u>	<u>Finish</u>	<u>List/ea</u>
4100-102	Oil R. Bronze	\$ 38.03
4105-030	Polished Brass	\$ 41.04
4105-102	Oil R. Bronze	41.04
4105-150	Satin Nickel	41.04

### Gray Rubber Replacement Tips

For Baldwin 4100 and 4105.



<u>Code</u>	<u>Ctn</u>	<u>List/ea</u>
4101	10/box	\$ 7.03

### IVES LEVER TYPE DOOR HOLDER

Solid cast aluminum



Lever projects 4".

Pack: 15/ Ctn.

<u>Code</u>	<u>Finish</u>	<u>List/ea</u>
SP455A3	Bright Brass	\$ 9.95
SP455A5	Ant. Brass	10.33
SP455A92	Nat. Aluminum	12.42



## WALL DOOR STOPS

1

### BALDWIN RIGID WALL TYPE DOOR STOP



Solid forged brass construction. Stem of bumper has hexagon shape for easy fastening without damaging finish. Resilient rubber tip is replaceable. Supplied with wood screws.

Projection: 3"

Code	Finish	List/ea
4045-003	Lifetime Pol. Brass	\$ 21.02
4045-050	Sat. Brass/Black	21.02
4045-102	Oil R. Bronze	21.02
4045-112	Venetian Bronze	21.02
4045-150	Satin Nickel	21.02
4045-260	Polished Chrome	21.02

Projection: 3.75"

4050-003	Lifetime Pol. Brass	\$ 21.02
4050-102	Oil R. Bronze	21.02
4050-150	Satin Nickel	21.02
4050-151	Antique Nickel	21.02
4050-260	Polished Chrome	21.02
4050-264*	Dull Chrome	21.02

\*disc when out

Projection: 3.4"



4055-102	Oil R. Bronze	\$ 21.02
4055-260	Polished Chrome	21.02

### REPLACEMENT TIPS FOR BALDWIN DOOR STOPS

For 4045 and 4050



**4041**

Code	Ctn	List/ea
4041	10 ea.	\$ 7.07

### IDH RIGID DOOR STOP

**13010**



Base Dia: 1-1/4", Proj. 3".  
Packed with an extra tip.

Code	Finish	List/ea
13010-003	Pol. Brass	\$ 7.58
13010-015	Satin Nickel	12.58
13010-019	Matte Black	13.19
13010-026	Pol. Chrome	13.58
13010-10B	Oil R Bronze	12.58
13010-26D	Satin Chrome	13.58

### IVES RIGID DOOR STOP



60 - 3.75" Proj.  
61 - 3" Proj.

Cast door stop with slip over rubber bumper. With integral screw.

Code	Finish	Proj.	Ctn	List/ea
60A3	Pol. Brass	3.75"	20 ea.	\$ 4.18
60A92	Aluminum	3.75"	20	4.10
SP61A3	Pol. Brass	3"	25	3.79
SP61A5	Ant. Brass	3"	25	4.70
SP61A92	Aluminum	3"	25	6.08
61AW	White	3"	10	5.40

### EMTEK RIGID DOOR STOPS

All Special Order.

Solid Brass.  
1-1/4" base diameter.



Available finishes:

Polished Brass (US3)	Pewter (US15A)
Satin Brass (US4)	Flat Black (US19)
French Antique (US7)	Polished Chrome (US26)
Oil Rubbed Bronze (US10B)	Medium Bronze (MB)
Polished Nickel (US14)	Tumbled Wh. Bronze (TWB)
Satin Nickel (US15)	Unlacquered Brass (US3NL)

Code	Description	List/ea
2232-	3" Door Stop	\$ 15
2231-	4" Door Stop	19



1

## DOOR STOPS

### IVES FLEXIBLE DOOR STOP



**SP061**  
4" Projection

"Quick-Stall" Flexible door stop. For use in locations where a standard door stop creates problems. Projection: 4". Base Dia: 1", Tip Dia: 9/16". Packed with screws.

Code	Finish	Ctn	List/ea
SP061F3	Pol. Brass	25 ea.	\$ 1.52
SP061F5	Ant. Brass	25	1.75
SP061F14	Brt. Nickel	25	1.83
061F26	Pol. Chrome	20	2.46



**SP060**  
3" Projection

Spring steel flexible door stop with slip over rubber bumper & integral screw. Projection: 3". Base Dia: 1", Tip Dia: 5/8".

Code	Finish	Ctn	List/ea
SP060F3	Pol. Brass	50 ea.	\$ 1.51
SP060F5	Ant. Brass	50	1.30
SP060F10B	Oil R. Bronze	50	1.25
SP060F14	Brt. Nickel	50	1.74

### PAMEX HEAVY DUTY SPRING STOP

Flexible



**DD02-31**  
3-1/8" Projection

3-1/8" Heavy Duty Spring Stop. Complete with 13/16" Screw and Metal Base. Proj: 3-1/8" from mounting surface. Base: 15/16" diameter.

Code	Finish	List/ea
DD02-31CP	Polished Chrome	\$.82
DD02-31SN	Satin Nickel	.90

### IVES HINGE PIN DOOR STOPS



**SP69F**



**SP70A**

Designed to fit most standard hinge pins and to allow the door to open fully without the knob hitting the wall. Adjustable.

Code	Finish	Ctn	List/ea
SP69F5	Antique Brass	25 ea.	\$ 3.74
SP69F3	Polished Brass	25	3.75
SP69F14	Bright Nickel	25	4.16
SP69F10B	Oil R. Bronze	25	4.98
SP70A92	Nat. Aluminum	25	\$ 2.27
SP70A3	Bright Brass	25	3.26
SP70A5	Antique Brass	25	2.60
70AW	White	20	4.67

### REPLACEMENT TIPS FOR IVES:

60, 61, 62, 062, 70, 430



**CRT6**

Off white color.

Code	Ctn	List/ea
CRT6	10 ea.	\$.52

### PAMEX HINGE PIN STOP



**DD02-40**

Zinc die-cast. Complete w/ rubber stop & plastic spacer. 1-5/8" Adjustable rubber head screw. Projection: 2", Overall Size: 2" x 1-7/16".

Code	Finish	List/ea
DD02-40OB	Oil R. Bronze	\$ 1.50
DD02-40SN	Satin Nickel	1.46



## WALL DOOR STOPS

### WALL TYPE DOOR STOP WITH HOLDER

Eric Morris

2354

Solid Forged Brass.  
Commercial Grade.



Base Dia: 2.25", Projection 3.5". Packed 5/box with wood and machine screws and expansion shields.  
Replacement Rubber: 2359 (Special Order).

Code	Finish	List/ea
2354-605	Pol. Brass	\$ 73.60
2354-613	Oil R. Bronze	72.80
2354-619	Satin Nickel	73.60

### TRIMCO WALL TYPE DOOR STOP HOLDER

Solid Brass. Base: 2-1/4", Proj. 3-3/4",  
Eye: 7/8 x 2-1/4", Hook: 2-3/4"

1206



Pack: 10 per box with wood screws.

Code	Finish	List/ea
1206-613	Oil R. Bronze	\$ 63.48
1206-626	Satin Chrome	61.01

### WALL TYPE DOOR STOP

Trimco

Solid Brass  
Base: 2-1/4"  
Projection: 3-1/2"



1204

Pack: 10 per box with wood screws.

Code	Finish	List/ea
1204-613	Oil R. Bronze	\$ 37.59
1204-626	Satin Chrome	30.05

## FLOOR DOOR STOPS

1

### BALDWIN FLOOR DOOR BUMPERS

Solid forged brass door bumpers are designed for use on doors with or without thresholds. 1 per carton with wood screws.  
2.062" Ht x 2.812" Length.



4510

Code	Finish	List/ea
4510-003	Polished Brass	\$ 42.04
4510-102	Oil R. Bronze	42.04
4510-150	Satin Nickel	42.04

### IDH FLOOR TYPE DOOR STOP & HOLDER

Solid Brass. Base Dia: 2-1/4",  
Height: 4", Clearance: 3-1/4".  
Packed with fasteners.



13020

Code	Finish	List/ea
13020-10B	Oil R. Bronze	\$ 39.43
13020-26D	Brushed Chrome	35.39

### TRIMCO FLOOR TYPE DOOR STOP



#### 1201 Floor Door Stop

Solid Brass. Height: 3", Base: 2-1/4".  
Pack: 10 per box with fasteners for wood, concrete or plaster.



#### 1223 Floor Door Stop w/ Holder

Solid Brass. Height: 3-5/8", Base: 2-1/4". Eye: 7/8" x 1-1/2", Hook: 2-3/4". Pack: 10 per box with fasteners for wood, concrete or plaster.

Code	Finish	List/ea
1201-605	Pol Brass	\$ 39.65
1201-613	Oil R. Bronze	43.09
1201-626	Satin Chrome	31.17
1223-613	Oil R. Bronze	\$ 73.86
1223-626	Satin Chrome	43.86



1

# FLOOR DOOR STOPS

## UNIVERSAL ROUND FLOOR BUMPER

Baldwin



4505

Solid Brass with concealed screw mounting. Overall Ht: 1.5", Dia: 1-3/16". Polybagged 10 ea/box with a wood screw and plastic anchor.

Code	Finish	List/ea
4505-003	Lifetime Polished Brass	\$ 34.03
4505-102	Oil R. Bronze	34.03
4505-150	Satin Nickel	34.03
4505-260	Polished Chrome	34.03

## CYLINDER FLOOR BUMBERS

All Special Order

Emtek

Flat Top

Dome Cap



2258 - 2"    2257 - 1-1/2"    2260 - 2"    2259 - 1-1/2"

Available finishes:

- Satin Brass (US4)
- Oil Rubbed Bronze (US10B)
- Polished Nickel (US14)
- Satin Nickel (US15)
- Flat Black (US19)
- Polished Chrome (US26)
- Unlacquered Brass (US3NL)

Code	Description	List/ea
2257-	1-1/2" Ht, Flat Top bumper	\$ 24
2258-	2" Ht, Flat Top bumper	26
2259-	1-1/2" Ht, Dome Cap bumper	24
2260-	2" Ht, Dome Cap bumper	26

## BALDWIN DOME TYPE DOOR BUMPER

Solid Brass



4000

4005

4010

Catalog Number	Height	Dia.	Base Height	For use w/ Threshold
4000	1" (25mm)	2" (51mm)	.187" (5mm)	---
4005	1.25" (32mm)	1.875" (48mm)	.375" (10mm)	.375 high (10mm)
4010	1.375" (35mm)	1.875" (48mm)	.5" (13mm)	.5" (13mm)

Packed with wood screws.

Code	Finish	Ctn	List/ea
4000-102	Oil R. Bronze	50	\$ 20.02
4000-150	Satin Nickel	50	20.02
4000-260	Polished Chrome	50	20.02
4000-264*	Dull Chrome	50	20.02
4005-030	Polished Brass	10	\$ 20.02
4005-102	Oil R. Bronze	10	20.02
4005-150	Satin Nickel	10	20.02
4005-260	Polished Chrome	10	20.02
4010-030	Polished Brass	40	\$ 20.02
4010-102	Oil R. Bronze	40	20.02
4010-150	Sat. Nickel	40	20.02
4010-260	Polished Chrome	40	20.02

\*disc when out

## RISER FOR BALDWIN DOOR BUMPER

For use on carpeted floors. Fits Baldwin No. 4000 bumper (see opposite column). 25/box.

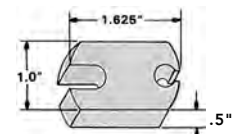

Code	Height	Finish	List/ea
4207-264	1/2"	Dull Chrome	\$ 12.01
4207-102	1/2"	Oil R. Bronze	10.76





# WALL DOOR STOPS

1

## **BALDWIN MODERN CONVEX DESIGN WALL BUMPER**



4252

Outside Dia: 1.75"  
Projection: 1"

Heavy wall bumper of brass and aluminum with rubber insert. Compact design is less obtrusive, blends with modern screwless appearance. 10 per box.

<u>Code</u>	<u>Finish</u>	<u>List/ea</u>
4252-102	Oil R. Bronze	\$ 18.02

Other finishes available special order.

## **BALDWIN WALL TYPE FLUSH BUMPERS**



4015

Dia: 1"  
Proj: .562"

A small size bumper for protection of walls where doors would strike them. Rubber center. 10 per box.

<u>Code</u>	<u>Finish</u>	<u>List/ea</u>
4015-264*	Dull Chrome	\$ 18.02
4015-260	Polished Chrome	18.02
4015-102	Oil R. Bronze	18.02

\*disc when out

## **BALDWIN MODERN CONCAVE DESIGN WALL BUMPER**

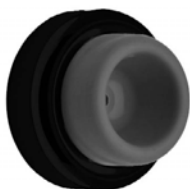

4273

Outside Dia: 1.75"  
Projection: 1"

<u>Code</u>	<u>Finish</u>	<u>Ctn</u>	<u>List/ea</u>
4273-102	Oil R. Bronze	50	18.02

## **IVES WALL TYPE DOOR BUMPER**



411RW

Outside Diameter: 1.75"  
Projection: 1"  
All rubber with adhesive back.

<u>Code</u>	<u>Color</u>	<u>Ctn</u>	<u>List/ea</u>
411RW	White	20	\$ 4.03

## **WALL BUMPERS All Special Order**

Emtek



2255

Choose from any of Emtek's rosette styles and finishes for these wall bumpers. See page 200 for some choices.

Ex. 2255 Contemporary Disc US15

<u>Code</u>	<u>Description</u>	<u>List/ea</u>
2255-	Wall bumper, Choose rosette and finish	\$ 19



# 1 ELECTRIC DOOR OPENERS

## TRINE ELECTRIC DOOR OPENERS



001                      004                      005

Designed for remote control of door locks for apartment buildings, businesses, public buildings, and anywhere security is required. Operate on 8 to 16 volts AC or 3 to 6 volts DC. Other voltages special order. US 4 Finish.

**Model 001:** For mortise bolt locks with latch bolt only. Reversible for LH or RH doors.  
Face: 5-7/8" x 1-1/4" x 1-9/16" deep.

001                      US 4 Finish                      List \$ 52.35 ea.

**Model 004:** For mortise bolt locks having a deadbolt and latch bolt. Opener operates latchbolt strike. Reversible for LH or RH doors.  
Face: 6-1/4" x 1-3/8". Case 1-7/8" x 2-3/4" x 1".  
1 per box.

004                      US 4 Finish                      List \$ 105.90 ea.

**Model 005:** For mortise bolt or regular key-in-handle sets. Reversible for LH or RH doors.  
Face: 3-1/2" x 1-3/8" x 2-7/8" deep.  
Model S-005 same as above for Schlage locks.

005                      US 4 Finish                      List \$ 76.25 ea.  
S005                      US 4 Finish                      82.80

## SECRET GATE LATCHES

Designed to restrict entry into fenced off areas in banks, stores, or public buildings. (Handle does not operate a latch.)

### **KNAPE & VOGT**

Cast Aluminum. 3 per box.

989AL                      \$ 35.83 ea.



### **PARKER**

Solid Cast Brass, Chrome Plate.  
1 per box.

551PC                      \$ 29.18 ea.



## Z INDUSTRIES PET DOORS

Deluxe Series Pet Doors

Colorful display box includes fasteners. Silver anodized frame will never rust. Easy installation in door or wall.



- Three sizes accommodate all pets: small cats to German Shepherds.
- Tough, long life, flexible rubber panel
- Permanent magnets keep door closed. No drafts or dust.
- Rigid hardboard security panel slips easily into guides on aluminum frames inside or outside.



Code	Flap	Cut-out	Overall
SD300	4-3/4 x 7-1/8	7-9/16 x 9-5/8	9-1/8 x 10-1/2
MD400	8-1/2 x 12-1/2	11-1/8 x 14-7/8	12-5/8 x 15-3/4
LD500	11-1/2 x 16-7/8	14 x 18-7/8	15-1/2 x 19-3/4
XLD600	14-1/2 x 19-1/2	17-1/4 x 21-7/8	18-3/4 x 22-3/4

Code	Description	List/ea
SD300	Small pet door	\$ 98.31
MD400	Medium pet door	171.43
LD500	Large pet door	230.72
XLD600	Xtra Large pet door	302.02



## DOOR CLOSERS

1

### NORTON DOOR CLOSERS

1600 Series



Series 1600 Norton closers with options for a variety of different installations. Use left or right handed without adapters. Regular or parallel arm applications with included adapter. Optional 90° - 180° holder arm or 90° - 180° fusible link holder arm. Adjustable power on closer and on door shoe. Two-tooth Rack-and-Pinion contact for smoother operation. Separate non-critical regulating valves for closing speeds and latch speed.

<u>No.</u>	<u>Max Door Size</u>		<u>No.</u>	<u>Max Door Size</u>	
	<u>Int.</u>	<u>Ext.</u>		<u>Int.</u>	<u>Ext.</u>
1602	2' 8"	N/A	1604	3' 8"	3' 6"
1603	3' 2"	3' 0"	1605	4' 2"	4' 0"

Use next size larger closer (larger no.) when using parallel arm type installation or for inswinging exterior doors. 6 ea/case.

<u>Code</u>	<u>Finish</u>	<u>List/ea</u>
1602BZ	Bronze	\$ 192.09
1603AL	Aluminum	203.62
1603BZ	Bronze	192.09
1603-690	Dark Bronze	222.82
1603HAL	Alum. w/ Hold-Open	233.62
1603HBZ	Bronze " "	220.40
1602AL*	Aluminum	
1604AL*	Aluminum	
1604BZ*	Bronze	
1605BZ*	Bronze	
1605-690*	Dark Bronze	

Call for Pricing

The 1602, 1604 and 1605 are also available with Hold-Open feature - Factory order.

### NORTON HANDICAPPED 1600 SERIES

With Barrier Free!

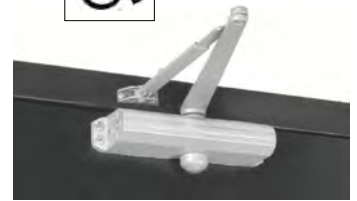

The Norton 1601BF door closer is basically the same as the other 1600 series closers, but has tremendous size flexibility. It fits interior doors up to 3' 8" and exterior doors up to 3' 6". The "BF" (Barrier Free) feature meets the requirements of the Americans with Disabilities Act (ADA) for reduced opening resistance.

Non-handed. Regular or parallel arm applications with included brackets. Adjustable spring power on closer. Two-tooth Rack-and-Pinion contact for smoother operation. Separate non-critical regulating valves for closing speeds, latch speed and back check. 6 ea/case.

<u>Code</u>	<u>Finish</u>	<u>List/ea</u>
1601BF-AL	Aluminum	\$ 192.09
1601BF-BZ	Bronze	192.09
1601BF-690	Dark Bronze	192.09



1

## DOOR CLOSERS

### NORTON 8501 SERIES



Adjustable on the door for sizes 2 through 6, meets exact wind or building pressure required. Back-check cushioning has separate adjustment valve for sweep latch and back-check. Non-handed; installs as regular, parallel arm, or top jamb. Aluminum alloy body, for a minimum interior door size of 30" and a maximum exterior door size of 48" (outswinging). "BF" indicates Barrier Free feature for low opening resistance. 4 ea/case.

Code	Description	List/ea
8501BF-BZ	Sprayed Bronze, BF	\$ 271.96
8501BF-AL	Aluminum, BF	271.96
8501BF-STAT	Dark Bronze, BF	293.72
8501BFH-AL	Alum, BF, Hold-Open	300.27
8501BFH-STAT	Dark Bronze, BF, Hold-Open	300.27

### NORTON 7500 SERIES

Special Order Only



Series 7500  
Installed Regular Arm

Narrow projection control: 2-1/8" projection. Functions and options are similar to the 8501 except that the 7500 is heavier duty and more suited for institutional and heavy traffic applications. For a maximum interior door size of 32" and a maximum exterior door size of 48" (inswinging).

Has "BF" Barrier Free feature for low opening resistance. For "Delayed Action" feature specify "DA" after the product code and add \$ 10.00 to the List price. All Special Order.

Code	Finish
7500BF-BZ	Sprayed Bronze
7500BF-AL	Aluminum

Call for Pricing

### LCN SUPER 'SMOOTHEE' SERIES

Special Order Only



The "Super Smoothee" was developed to answer the need for a single, non-handed, heavy duty door closer with spring power. Adjustable from sizes 2 through 6.



For Over Door Mounting:

1. Maximum Reveal: 2-9/16"
2. For reveals 2-9/16" through 4-13/16" (6-3/4" frame) please specify 4040-long rod.

The 4041 Series cylinders are adjustable from sizes 1 through 6. It is Barrier Free on sizes 1 through 5. Non-handed. Please Specify Aluminum or Bronze Finish.

Code	Description
4041	Regular
4041H	Hold-Open
4041P	Parallel Arm

Call for Pricing

For "Delayed Action" feature add "DEL" to part number and add \$ 73.00 to the List.

### LCN DOOR HANDING

The 4041 Series shown above is non-handed. When ordering the 4010/4110 Series shown on the following page, handing needs to be specified.

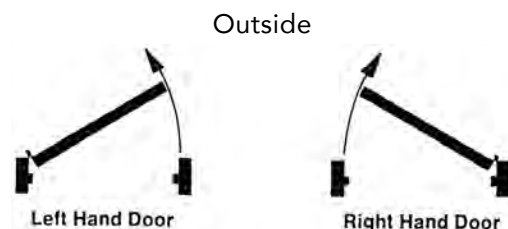



**LCN**

**DOOR CLOSERS**

1

The 4010 / 4110 SMOOTH™ Series is LCN's best performing heavy duty closer designed specifically for institutional and other rugged high traffic applications. Cast iron, forged steel closer arm, powder coated finish. UL & CUL listed (without hold-open), ANSI Standard A156.4, Grade One. Order the 4010 Series for Hinge Side Mount, order 4110 Series for Parallel Arm Mount. Specify hand of door when ordering. The 4011 and the 4111 have cylinders that meet ADA requirements.

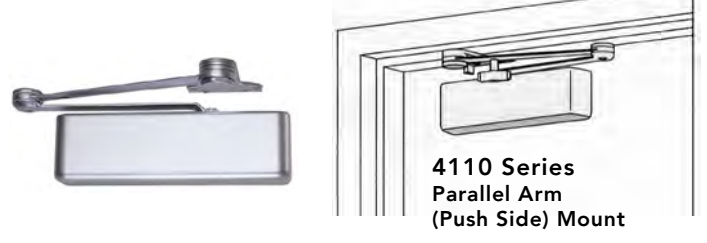
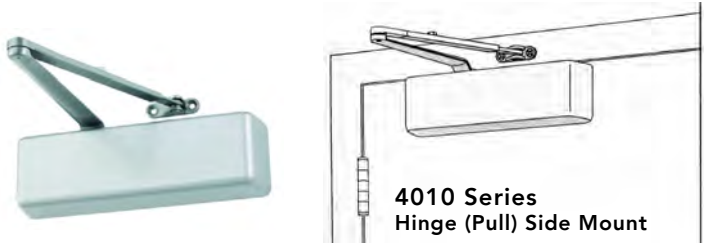

**Table of Sizes:** Select closer based on width of door. The spring power of non-sized 4011 cylinder is adjustable from size 1 through size 5 and is shipped set to size 3. Sized 4010 series cylinders available in size 2, 3, 4, 5 or 6. Closing power of all 4010 Series closers may be increased 50%. Specify next higher size closer where strong draft exists.

**Table of Sizes:** Select closer based on width of door. The spring power of non-sized 4111 cylinder is adjustable from size 1 through size 5 and is shipped set to size 3. Sized 4110 series cylinders available in size 2, 3, 4, 5 or 6. Closing power of all 4110 Series closers may be increased 50%. Specify next higher size closer where strong draft exists. Delayed action not available with 4115 or 4116 cylinder.

→ Indicates recommended range of door width for closer size.

→ Indicates recommended range of door width for closer size.

**Exterior (and Vestibule) Door**

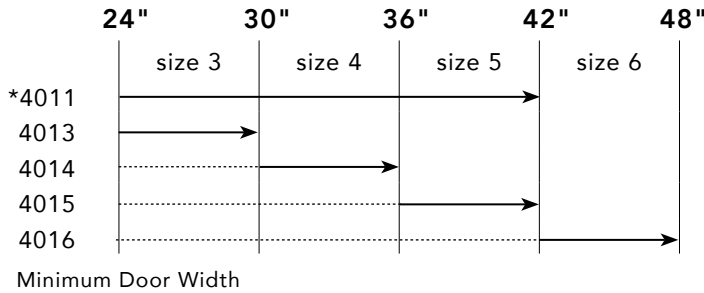

**Exterior (and Vestibule) Door**

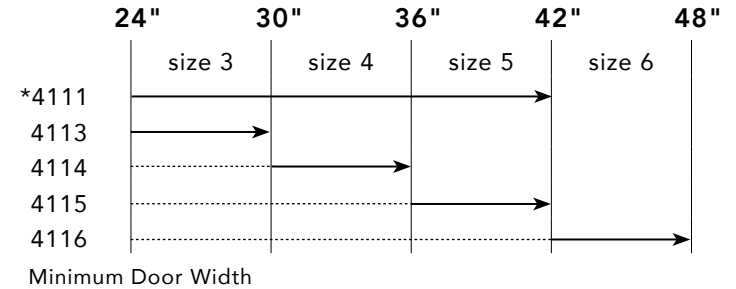

**Interior Door Width**

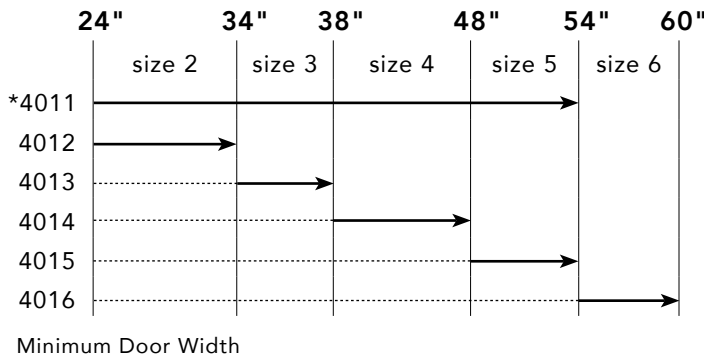

**Interior Door Width**

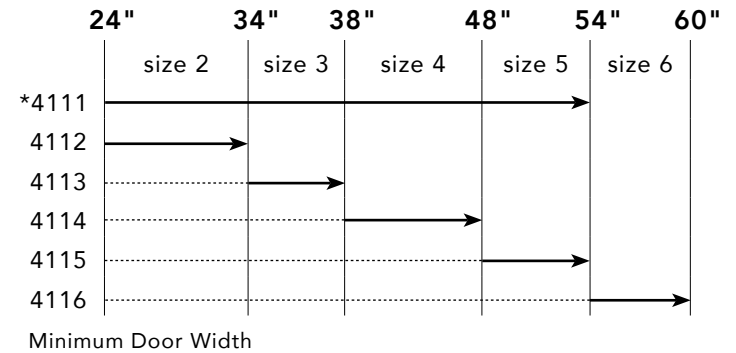

**4010 Series Call for Pricing**

Specify Aluminum or Bronze and Specify hand of door (chart on prev. page). Delivery time: 4 days. Add \$ 31.69 for DEL (delay of action)

**4110 Series Call for Pricing**

Specify Aluminum or Bronze and Specify hand of door (chart on prev. page). Delivery time: 4 days. Add \$ 31.69 for DEL (delay of action)

**\* Reduced opening force on 4011 and 4111 closers. Caution!**  
Any manual door closer, including those certified by BHMA to conform to ANSI Standard A156.4, that is selected, installed and adjusted base on ADA or other reduced opening force requirements may not provide sufficient power to reliably close and latch a door. (Refer to LCN "Power Operators" for systems that meet reduced opening force requirements without effecting closing power.)

	Door Width	36"	42"	48"
	8.5* lbs.	4011/4111	4011/4111	4011/4111
5.0* lbs.	4011/4111	4011/4111	4011/4111	

\* Maximum opening force



1

# FLUSH BOLTS

## SLIDING ACTUATOR TYPE FLUSH BOLTS

Flush bolts mortise into door edge and are actuated by sliding handle up and down.

**TRIMCO:** Forged brass, aluminum or bronze. Face: 6" long x 3/4" wide. Bolt: 1/2" diameter with 1" throw. 10 per box. Square End.



Code	Finish	List/ea
3999SE-605	Brt. Brass	\$ 15.91
3999SE-609	Ant. Brass	18.08
3999SE-625	Brt. Chrome	15.12
3999SE-626	Dull Chrome	13.70
3999SE-613	Oil R. Bronze	15.91
3999SE-619	Sat. Nickel	19.21
With Rounded End: 10/box		
3999-605	Pol. Brass	\$ 13.59
3999-613	Oil R Bronze	17.20
3999-619	Satin Nickel	21.99

## BALDWIN RESIDENTIAL FLUSH BOLT

Solid forged brass construction. Length: 6". 1" Throw. Sharply defined edge and recess. Smooth working action with automatic holding spring for both retracted and projected positions. High quality flush bolt not to be confused with wrought metal types. Packed with fasteners.

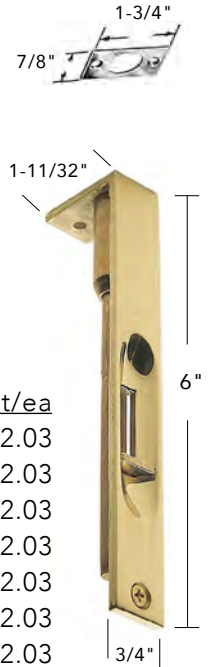

Code	Finish	List/ea
0626-003	Lifetime Pol. Brass	\$ 32.03
0626-050	Sat. Brass/Black	32.03
0626-056	Lifetime Sat. Nickel	32.03
0626-060	Sat. Brass/Brown	32.03
0626-102	Oil R. Bronze	32.03
0626-260	Pol. Chrome	32.03
0626-264*	Dull Chrome	32.03
0626-112	Venetian Bronze	32.03
0626-151*	Antique Nickel	32.03

\*disc when out

## LEVER ACTUATOR FLUSH BOLTS

**TRIMCO:** Forged brass or bronze. Overall: 1" x 6-3/4", Throw: 11/16". Supplied w/ 12" rod. 1 per pack.

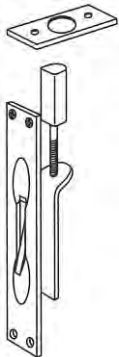

Code	Finish	List/ea
3917-12-605	Brt. Brass	\$ 28.80
3917-12-613	Oil R. Bronze	28.91
3917-12-626	Dull Chrome	23.06
3917-12-619	Sat. Nickel	56.62

## BALDWIN EXTENSION FLUSH BOLT

Solid hot forged brass extension flush bolt has over 3/4" throw. Unique push button design of lever and delay action for easy operation. Lever does not engage bolt until it is hinged freely to 45° angle. At this position it is easy to move the bolt head. Lever snaps automatically when hinged beyond 45° angle. Made to template for easy installation in metal door frames. Faceplate: 1" x 6.75", Rod: 12". Packed with fasteners.

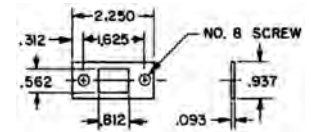

Code	Finish	List/ea
0600-003	Lifetime Pol. Brass	\$ 75.07
0600-056	Lifetime Sat. Nickel	75.07
0600-050	Satin Brass/Black	75.07
0600-102	Oil R Bronze	75.07
0600-260	Polished Chrome	75.07
0600-264*	Dull Chrome	75.07
0600-112	Venetian Bronze	75.07
0600-151*	Antique Nickel	75.07

\*disc when out

## FLUSH BOLTS

1

### IDH FLUSH BOLT

Solid Brass

6" Flush Bolt  
with Square End

Length: 6"  
Width: 3/4"  
Throw: 1"  
Strike: 7/8" x 1-3/4"



- Smooth sliding
- Double action spring holds bolt in retracted or extended positions

Code	Finish	Ctn	List/ea
11010-003	Polished Brass	10 ea.	\$ 19.25
11010-005	Antique Brass	10	17.19
11010-015	Satin Nickel	10	29.73
11010-026	Polished Chrome	10	26.64
11010-10B	Oil R Bronze	10	26.64
11010-26D	Satin Chrome	10	24.23

### IDH EXTENSION FLUSH BOLT

Solid Brass

12" Extension Flush Bolt

Length: 6-3/4"  
Width: 1"  
Throw: 1"  
Strike: 2" x 1"  
Strike: 2-1/2" x 1"

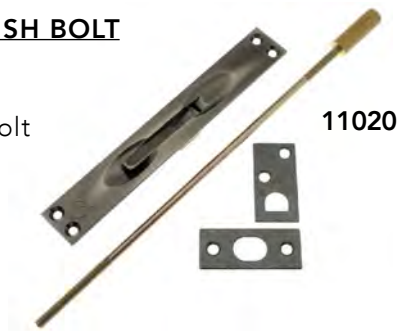

Code	Finish	Ctn	List/ea
11020-003	Polished Brass	10 ea.	\$ 24.00
11020-005	Antique Brass	10	36.12
11020-015	Satin Nickel	10	28.00
11020-026	Polished Chrome	10	36.12
11020-10B	Oil R Bronze	10	52.69
11020-26D	Satin Chrome	10	52.65

### ERIC MORRIS

#### EXTENSION FLUSH BOLT

Special Order

Solid Brass extension bolt has a 3/4" throw. Lever engages bolt approx. 45° for greater leverage and easier operation. Lever snaps home in both closed and open positions.

Length: 6.75", Width: 1", Bolt: 1/2"  
Throw: 3/4"

Polybagged with fasteners and 12" rods.

Code	Finish	Ctn	List/ea
2202-613*	Oil Rubbed Bronze	2	\$ 67.51
2202-619*	Satin Nickel	2	67.51



### ERIC MORRIS HIGH SECURITY RESIDENTIAL FLUSH BOLT

Solid extruded brass construction. Lever engages bolt at approximately 45° for greater leverage and easier operation. Lever snaps home in both closed and open positions. The lever design offers the security of an extension bolt with the smaller size and ease of installation of a residential flush bolt.

Length: 6", Width: 3/4"  
Bolt: 1/2", Throw: 3/4"  
Polybagged with fasteners.

Code	Finish	List/ea
2203-605E	Pol. Brass, Lifetime	\$ 71.68
2203-613*	Oil R. Bronze	67.51
2203-619*	Satin Nickel	67.51



# 1 THRESHOLDS

## PEMKO THRESHOLDS

### Residential Saddle Thresholds

Threshold for low rug design.  
 Shown with P210 door shoe.  
 (Door shoe not included.)

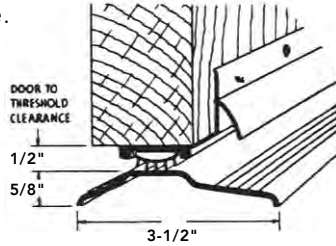

Code	Size	Finish	List/ea
P212A	36"	Mill Finish Alum	\$ 24.00
P212D	36"	Dark Bronze	39.71
P212BDG*	36"	Bright Dip Gold	37.00
P212D-6	72"	Dark Bronze	78.71

\*disc. when out

Threshold for high rug design.  
 Shown with P210 door shoe.  
 (Door shoe not included.)

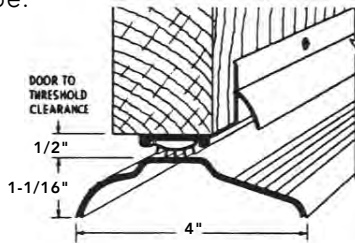
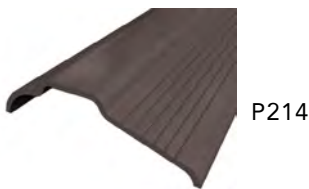

Code	Size	Finish	List/ea
P214D	36"	Dark Bronze	\$ 38.55
P214D-6	72"	Dark Bronze	77.94

## PEMKO

### PEMKO #145 WATER RETURN INTERLOCKING THRESHOLD



Catches any water which may blow or run under door and returns it to the outside. #61 hook is furnished with threshold. Drain Pan included on Dark Bronze finishes, otherwise Special Order.

Code	Size	Finish	List/ea
145A-3	36"	Aluminum	\$ 47.59
145D-3	36"	Dark Bronze	81.21
145A-6	72"	Aluminum	114.03
145D-6	72"	Dark Bronze	150.50

Can also be special ordered in Brass.

### PEMKO #110 INTERLOCKING THRESHOLD

Special Order - Call for Price

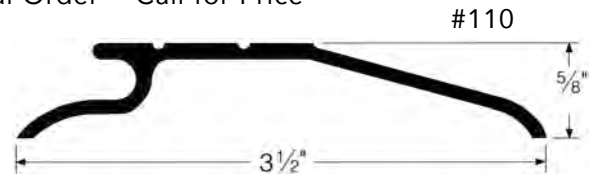

Interlocking threshold comes with #61 hook and nails, but may be fitted with a variety of hooks, according to need.

**Special Order** in A, B, D finishes (see chart below).

### HOOKS - Special Order

When installed properly on bottom of door, hooks interlock with threshold for a tight seal. BHMA certified.

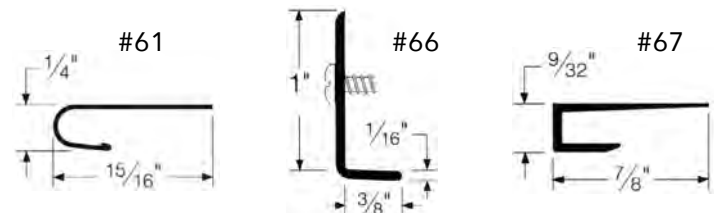

### Finish Codes:

<b>A</b> Mill Finish Aluminum	<b>G</b> Gold (Ano. Alum.)
<b>B</b> Ext. Bronze (Brass)	<b>PW</b> Painted Wht Alum
<b>BDG</b> Bright Dip Gold	<b>SN</b> Satin Nickel
<b>D</b> Dark Bronze (Ano. Alum.)	



## THRESHOLDS

### AUTOMATIC DOOR BOTTOM #SA

Surface Mount

Lifts to clear rugs,  
 shuts to seal out  
 weather.

10 per box.

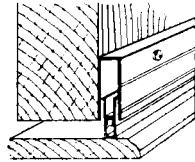

Code	Finish	Size	List/ea
SA2	Mill Finish	30" - 32" Door	\$ 62.13
SA3	Mill Finish	34" - 36" Door	61.41
SA2D	Dark Bronze	30" - 32" Door	73.92
SA3D	Dark Bronze	34" - 36" Door	83.48

### AUTOMATIC DOOR BOTTOM #411

Full Mortise, Non-Handed



#411ARL

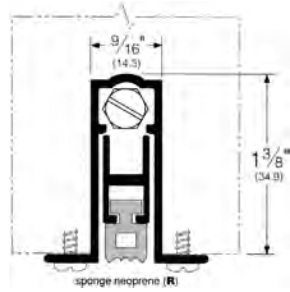

Code	Finish	Size	List/ea
411ARL-36	Mill Finish	34" - 36"	\$ 69.21
411ARL-48	Mill Finish	46" - 48"	78.86

## RAIN DRIP

Aluminum deflects rain away from bottom or top of door or window. Heavy duty, screw-on. Length: 36". Aluminum finish provided with a vinyl insert.



P345AV

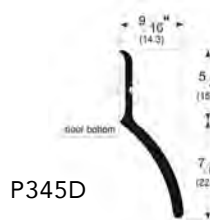
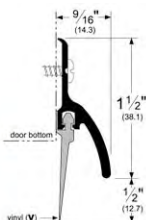

P345D

Code	Finish	Ctn	List/ea
P345D	Dark Bronze	10	\$ 16.65
P345AV	Mill Finish	10	15.89

## PEMKO

### DOOR SHOES #210

Door shoe with drip lip fits doors 1-3/8" and larger. 36" long, Black insert.



10 per carton.

Code	Size	Finish	List/ea
P210AV	36"	Mill Finish	\$ 22.28
P210DV	36"	Dark Bronze	24.63

## DOOR SHOES

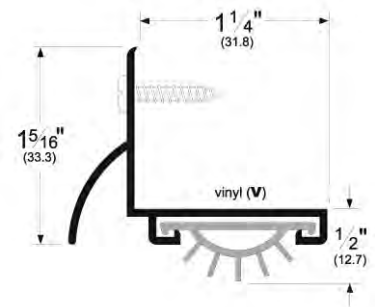

P210AV: Extruded Aluminum, slotted holes, vinyl insert

### DOOR SHOES

Door shoe with drip lip. 215 model for 1-3/8" doors, 216 model is for 1-3/4" doors. Black insert.

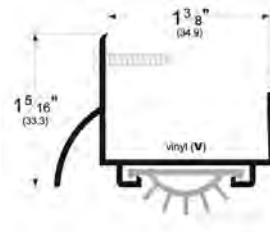

215

For 1-3/8" Door

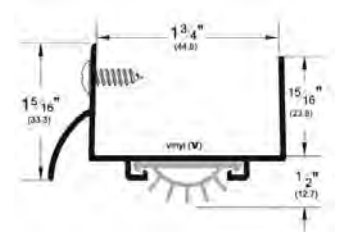

216

For 1-3/4" Door

Code	Finish	Ctn	List/ea
P215DV	Dark Brz/Vinyl, 36"	10	\$ 26.83
P215AV	Aluminum/Vinyl, 36"	10	17.25
P216DV	Dark Brz/Vinyl, 36"	10	28.33
P216AV	Aluminum/Vinyl, 36"	10	22.20

### DOOR SWEEP

This brush gasketing is supplied with a Nylon Brush insert. 36" length, Dark Bronze finish.



18061

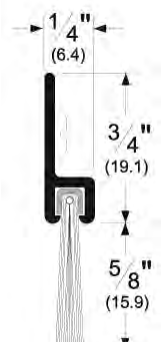

Code	List/ea
18061DNB36	\$ 21.01



1

# PEMKO

## DOOR SWEEP

Aluminum & vinyl door sweep.  
Length: 36". 10 per ctn.



P307AV

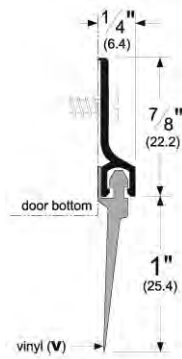

Code	Description	List/ea
P307AV	Aluminum & Vinyl	\$ 11.30
P307DV	Dark Bronze & Vinyl	14.58
P307GV*	Gold Anod. & Vinyl	12.47
P307WV	Paint White & Vinyl	12.09

\*disc. when out

## SILICON SEAL PRESSURE SENSITIVE DOOR GASKETING

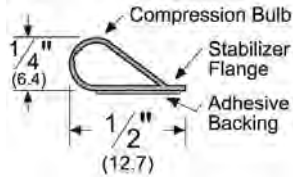
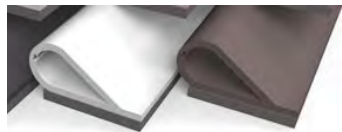

Silicon Seal adhesive-backed fire/smoke gasketing. Begins compressing at 1/4" and can be compressed sufficiently to seal 1/16" toleranced openings. Will not lose its form. 21' coil.

Code	Description	List/ea
S88W-21	21', White	\$ 36.88
S88D-21	21', Dark Bronze	43.32

## KERF WEATHERSTRIP

Min space between door face and stop is 5/16". Max space is 1/2". Conforms well to irregularities in door fit and finish for a tight seal and low air infiltration. Includes rigid PVC insert with extended flange for easy kerf installation.

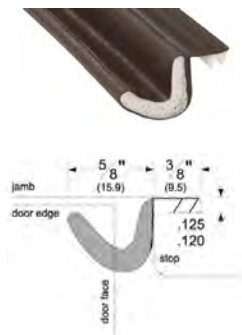

Code	Description	List/ea
Q102D-97	97", Dark Brown Foam	\$ 25.00
Q102W-97	97", White Foam	25.00

# WEATHERSTRIP

## WEATHERSTRIP PRODUCTS

### Spring Bronze Weatherstrip

Spring metal weatherstrip in 17' sets to fit standard doors to 36" wide & 84" tall. 10 per ctn.



P51 Spring Metal

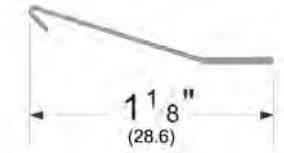

Code	Finish	List/ea
P51B	Bronze Metal	\$ 60.99

### Cushion/Spring Weatherstrip

Bronze cushion metal weatherstrip in 17' sets to fit doors 36" wide and 84" tall. Nail should be approximately 3" on center. 10 per ctn.

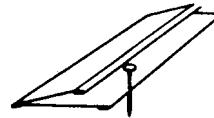

P74B-17  
Bronze Cushion Metal

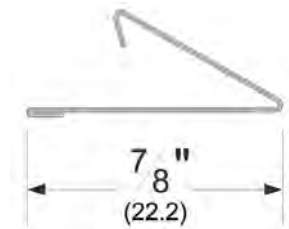

Code	Finish	List/ea
P74B-17	Bronze Metal	\$ 82.10

## ADHESIVE FOAM TAPE



### Open Cell Polyurethane Tape

Self-adhesive strips in 17' coils. Use for weatherstrip, cushions, and insulation. 10 rolls/box.

Code	Color	Size	List/rl
P396	Charcoal	1/4" T x 1/2" W x 17' L	\$ 7.70



### Closed Cell Neoprene Tape

Remains flexible at high/low temps. Self adhesive, available in 10' lengths.

P380	Black	3/16" T x 3/8" W x 10' L	\$ 6.39
P381	Black	5/16" T x 3/8" W x 10' L	7.77

# EMTEK LOCKS

2

## EMTEK SELECT LEVER & KNOB SETS

Mix-Match Style & Finish for lever/knobs, stems and rosettes

- 6 lever/ 3 knob designs in 7 finishes
- Any style rosette in available finishes
- Complete set includes latch, strike plate and dust box
- Standard latch is 2-3/8" backset - Specify 2-3/4" backset if required
- 3 lever stem designs in 7 finishes
- Levers include 28° rotation latch
- Handing required for lever sets (see pg 208 for chart)



**All Special Order  
 Lead time 7-10  
 business days\***

Available in Passage, Privacy and Dummy sets.  
 Concealed Fastener (CF) Mechanism available.

**Standard sets List \$ 220, CF sets List \$ 262**



R-Bar . Straight Knurled  
 w/ Watford Rosette



R-Bar . Hammered  
 w/ Urban Modern Rosette



T-Bar . Knurled  
 w/ Urban Modern Rosette



T-Bar . Faceted  
 w/ Disk Rosette



L-Square . Tribeca  
 w/ Urban Modern Rosette



L-Square . White Marble  
 w/ Wilshire Rosette



Conical . White Marble  
 w/ Disk Rosette



Conical . Knurled  
 w/ Mod. Rect. Rosette



Conical . Straight Knurled  
 w/ Urban Modern Rosette



Conical . Knurled  
 w/ Watford Rosette



Conical . Straight Knurled  
 w/ Wilshire Rosette

### Rosette options



For Technical Specs and Installation Instructions on Emtex products, visit [emtek.com](http://emtek.com) and go to SUPPORT.

### Finish options



# EMTEK LOCKS

2

**All Special Order**  
**Lead time 7-10**  
**business days\***

## EMTEK BRASS MODERN INTERIOR LEVER & KNOB SETS

- Complete set includes latch, strike plate and dust box
- Standard Latch is 2-3/8" backset - Specify 2-3/4" backset if required.
- Handing required for leversets (see pg 208 for chart)
- Available in Passage, Privacy and Dummy sets
- Concealed Fastener (CF) Mechanism available (w/ 28° latch for leversets)

### Knobsets - Studio Brass

### Rosettes for Studio Brass

Standard sets List \$ 265, **CF sets List \$ 307**



Spoke Knob  
 w/ Mod Rectangular Rosette



The Ace Knurled Knob  
 w/ Quincy Rosette



The Ace Knob  
 w/ Disk Rosette



Disk



Square



Modern Rectangular



Urban Modern



Quincy

### Finish options for Studio Brass



Satin Brass  
 US4



French Antique  
 US7



Polished Nickel  
 Lifetime US14



Satin Nickel  
 US15



Pewter  
 US15A



Flat Black  
 US19



Pol Chrome  
 US26



Matte White  
 MW



Satin Rose Gold  
 SRG



Unlacquered  
 Brass US3NL

**\*Upcharge**

### Lever and Knobsets - Modern Classic Brass

**\*\*Available in Stainless Steel**

Standard sets List \$ 148, **CF sets List \$ 196 (leversets), \$ 190 (knobsets)**



Athena Lever  
 w/ Neos Rosette



Helios Lever\*\*  
 w/ Square Rosette



Hermes Lever  
 w/ Modern Rosette



Luzern Lever  
 w/ Square Rosette



Poseidon Lever\*\*  
 w/ Modern Rect Rosette



Stuttgart Lever\*\*  
 w/ Square Rosette



Round Knob\*\*  
 w/ Modern Rect Rosette



Orb Knob  
 w/ Urban Mod Rosette

### Rosette options



Modern



Disk



Square



Neos



Modern Rectangular



Urban Modern

### Finish options



Satin Brass  
 US4



Oil R Bronze  
 US10B



Polished Nickel  
 Lifetime US14



Satin Nickel  
 US15



Flat Black  
 US19



Pol Chrome  
 US26



Unlacquered  
 Brass US3NL  
 \*Upcharge



# EMTEK LOCKS

2

## EMTEK BRASS MODERN INTERIOR LEVER SETS



















- Complete set includes latch, strike plate and dust box
- Standard Latch is 2-3/8" backset - Specify 2-3/4" backset if required.
- Handing required for leversets (see pg 208 for chart)
- Available in Passage, Privacy and Dummy sets
- Concealed Fastener (CF) Mechanism available (w/ 28° latch for leversets)

**All Special Order  
Lead time 7-10  
business days\***

**Standard sets List \$ 187, CF sets List \$ 235**

### Leversets - Modern Designer Brass

\*Available in Stainless Steel

 Argos Lever w/ Square Rosette	 Aston Lever w/ Disk Rosette	 Basel Lever w/ Disk Rosette	 Breslin Lever w/ Neos Rosette	<p>Rosette options</p>  Modern  Disk  Square  Neos  Modern Rectangular  Urban Modern
 Dumont Lever w/ Modern Rect Rosette	 Freestone Lever w/ Urban Mod Rosette	 Geneva Lever w/ Modern Rect Rosette	 Hercules Lever* w/ Square Rosette	
 Sion Lever w/ Disk Rosette	 Triton Lever w/ Modern Rect Rosette	 Mercury Lever w/ Square Rosette	 Myles Lever w/ Neos Rosette	
 Spencer Lever w/ Modern Rosette				

### Finish options

						
Satin Brass US4	Oil R Bronze US10B	Polished Nickel Lifetime US14	Satin Nickel US15	Flat Black US19	Pol Chrome US26	Unlacquered Brass US3NL *Upcharge

For Technical Specs and Installation Instructions on Emtek products, visit [emtek.com](http://emtek.com) and go to SUPPORT.

# EMTEK LOCKS

2

**All Special Order**  
**Lead time 7-10**  
**business days\***

## EMTEK BRASS MODERN INTERIOR KNOB SETS

- Complete set includes latch, strike plate and dust box
- Standard Latch is 2-3/8" backset - Specify 2-3/4" backset if required.
- Available in Passage, Privacy and Dummy sets
- Concealed Fastener (CF) Mechanism available

**Standard sets List \$ 187, CF sets List \$ 229**

### Knobsets - Modern Designer Brass

\*Available in Stainless Steel



Bern Knob  
w/ Square Rosette



Freestone Knob  
w/ Urban Mod Rosette



Laurent Knob  
w/ Modern Rect Rosette



Octagon Knob\*  
w/ Modern Rosette



Hammered Egg Knob  
w/ Disk Rosette



Square Knob  
w/ Neos Rosette



Verve Knob  
w/ Square Rosette

#### Rosette options



Modern



Disk



Square



Neos



Modern Rectangular



Urban Modern

### Knobsets - Modern Crystal



Bristol Crystal Knob  
w/ Square Rosette



Hampton Crystal Knob  
w/ Neos Rosette



Modern Disk Crystal Knob  
w/ Disk Rosette



Windsor Crystal Knob  
w/ Modern Rect Rosette



Modern Square Crystal Knob  
w/ Urban Mod Rosette

### Finish options



Satin Brass  
US4



Oil R Bronze  
US10B



Polished Nickel  
Lifetime US14



Satin Nickel  
US15



Flat Black  
US19



Pol Chrome  
US26



Unlacquered  
Brass US3NL  
\*Upcharge

For Technical Specs and Installation Instructions on Emtek products, visit [emtek.com](http://emtek.com) and go to SUPPORT.

# EMTEK LOCKS

2

**All Special Order  
 Lead time 7-10  
 business days\***

## EMTEK CLASSIC BRASS INTERIOR LEVER & KNOB SETS

- Complete set includes latch, strike plate and dust box
- Standard Latch is 2-3/8" backset - Specify 2-3/4" backset if required.
- Handing required for leversets (see pg 208 for chart)
- Available in Passage, Privacy and Dummy sets
- Concealed Fastener (CF) Mechanism available (w/ 28° latch for leversets)

**Standard sets List \$ 148, CF sets List \$ 196 (leversets), \$ 190 (knobsets)**

### Leversets - Classic Brass



Cortina Lever  
 w/ #8 Rosette



Merrimack Lever  
 w/ Rectangular Rosette

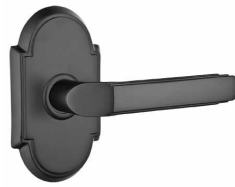

Milano Lever  
 w/ #8 Rosette



Turino Lever  
 w/ Oval Rosette



Manning Lever  
 w/ Watford Rosette

### Knobsets - Classic Brass



Egg Knob  
 w/ Oval Rosette



Melon Knob  
 w/ Regular Rosette



Norwich Knob  
 w/ Regular Rosette



Providence Knob  
 w/ Quincy Rosette



Waverly Knob  
 w/ Quincy Rosette

### Finish options



Polished Brass  
 US3



French Antique  
 US7



Polished Nickel  
 Lifetime US14



Pewter  
 US15A



Pol Chrome  
 US26



Satin Brass  
 US4



Oil R Bronze  
 US10B



Satin Nickel  
 US15



Flat Black  
 US19



Unlacquered  
 Brass US3NL  
 \*Upcharge

### Rosette options



#8



Oval



Regular



Rectangular



Quincy



Watford



Wilshire



Rope\*



Lancaster\*



Ribbon  
 & Reed\*

\* Not available in  
 US4, US14, US19

# EMTEK LOCKS

2

**All Special Order**  
**Lead time 7-10**  
**business days\***

## EMTEK DESIGNER BRASS INTERIOR LEVER & KNOB SETS

- Complete set includes latch, strike plate and dust box
- Standard Latch is 2-3/8" backset - Specify 2-3/4" backset if required.
- Available in Passage, Privacy and Dummy sets
- Handing required for leversets (see pg 208 for chart)
- Concealed Fastener (CF) Mechanism available (w/ 28° latch for leversets)

**Standard sets List \$ 187, CF sets List \$ 235 (leversets), \$ 229 (knobsets)**

### Leversets - Designer Brass



Coventry Lever  
w/ Regular Rosette

Elan Lever  
w/ Oval Rosette

Ribbon & Reed Lever  
w/ Ribbon & Reed Rosette

Rope Lever  
w/ Rope Rosette

Rustic Lever  
w/ Oval Rosette

Santa Fe Lever  
w/ Rope Rosette

Wembley Lever  
w/ Regular Rosette

### Rosette options



### Knobsets - Designer Brass



Beaded Egg Knob  
w/ Oval Rosette

Victoria Knob  
w/ #8 Rosette

Belmont Knob  
w/ Wilshire Rosette

Rope Knob  
w/ Rope Rosette

Lancaster Knob  
w/ Lancaster Rosette

Ribbon & Reed Knob  
w/ Ribbon & Reed Rosette

For Technical Specs and Installation Instructions on Emtek products, visit [emtek.com](http://emtek.com) and go to SUPPORT.

### Finish options





# EMTEK LOCKS

2

**All Special Order  
 Lead time 7-10  
 business days\***

## EMTEK INTERIOR KNOB & LEVERSETS

- Complete set includes latch, strike plate and dust box
- Standard Latch is 2-3/8" backset - Specify 2-3/4" backset if required.
- Handing required for leversets (see pg 208 for chart)
- Available in Passage, Privacy and Dummy sets
- Concealed Fastener (CF) Mechanism available (w/ 28° latch for leversets)

**Knobsets - Crystal** Standard sets List \$ 187, **CF sets List \$ 229**



Old Town  
 Crystal Knob  
 w/ #8 Rosette



Providence  
 Crystal Knob  
 w/ Lancaster Rosette



Bristol  
 Crystal Knob  
 w/ Wilshire Rosette



Georgetown  
 Crystal Knob  
 w/ Rectangular Rosette



Hampton  
 Crystal Knob  
 w/ Oval Rosette



Lowell  
 Crystal Knob  
 w/ Watford Rosette



Windsor  
 Crystal Knob  
 w/ Quincy Rosette



Astoria  
 Crystal Knob  
 w/ Rope Rosette



Diamond  
 Crystal Knob  
 w/ Ribbon & Reed Rosette

### Finish options for above knobsets



Polished Brass  
 US3



French Antique  
 US7



Polished Nickel  
 Lifetime US14



Pewter  
 US15A



Pol Chrome  
 US26



Satin Brass  
 US4



Oil R Bronze  
 US10B



Satin Nickel  
 US15



Flat Black  
 US19



Unlacquered  
 Brass US3NL  
 \*Upcharge

## Leversets & Knobsets - Arts & Crafts

Standard sets List \$ 187, **CF sets List \$ 235 (leversets), \$ 229 (knobsets)**



Arts & Crafts Lever  
 w/ Arts & Crafts Rosette



Hammered Lever  
 w/ Hammered Rosette

Arts & Crafts Sets may also be ordered with any Modern Brass/ Brass Rosette style. Available finishes:



Oil R Bronze  
 US10B



Satin Nickel  
 US15



Flat Black  
 US19



Unlacquered  
 Brass US3NL  
 \*Upcharge

### Rosette options



#8



Oval



Regular



Rectangular



Quincy



Watford



Wilshire



Rope\*



Lancaster\*



Ribbon  
 & Reed\*

\* Not available in  
 US4, US14, US19

# EMTEK LOCKS

2

**All Special Order**  
**Lead time 7-10**  
**business days\***

## EMTEK SANDCAST BRONZE INTERIOR LEVER & KNOB SETS

- Complete set includes latch, strike plate and dust box
- Standard Latch is 2-3/8" backset - Specify 2-3/4" backset if required.
- Available in Passage, Privacy and Dummy sets
- Handing required for leversets (see pg 208 for chart)
- Concealed Fastener (CF) Mechanism available (w/ 28° latch for leversets)

**Standard sets List \$ 215, CF sets List \$ 263 (leversets), \$ 257 (knobsets)**

### Lever sets & Knobsets - Sandcast Bronze



Yuma Lever  
w/ #6 Rosette



Montrose Lever  
w/ #1 Rosette



Durango Lever  
w/ #1 Rosette



Cimarron Lever  
w/ #2 Rosette



Cody Lever  
w/ #3 Rosette



Lariat Lever  
w/ #4 Rosette



Teton Lever  
w/ #4 Rosette



Aurora Lever  
w/ #6 Rosette



Bryce Lever  
w/ #6 Rosette



Mariposa Lever  
w/ #2 Rosette



Winchester Knob  
w/ #3 Rosette



Butte Knob  
w/ #1 Rosette



Round Knob  
w/ #6 Rosette



Egg Knob  
w/ #2 Rosette



Some Crystal knobsets also available with Sandcast bronze rosettes.

Lowell  
Crystal Knob  
w/ #4 Rosette

#### Rosette options



#1



#2



#3



#4



#6

#### Finish options



Flat Black  
Bronze  
FB



Medium  
Bronze  
MB



Tumbled  
White Bronze  
TWB

For Technical Specs and Installation Instructions on Emtex products, visit [emtek.com](http://emtek.com) and go to SUPPORT.

# EMTEK LOCKS

2

## EMTEK INTERIOR KNOB & LEVERSETS

- Complete set includes latch, strike plate and dust box
- Standard Latch is 2-3/8" backset - Specify 2-3/4" backset if required.
- Handing required for leversets (see below for chart)
- Available in Passage, Privacy and Dummy sets
- Concealed Fastener (CF) Mechanism available (w/ 28° latch for leversets)

**All Special Order  
 Lead time 7-10  
 business days\***

**Standard sets List \$ 215, CF sets List \$ 263 (leversets), \$ 257 (knobsets)**

### Leversets & Knobsets - Lost Wax Cast Bronze

 Medici Lever w/ #14 Rosette	 Napoli Lever w/ #12 Rosette	 Octagon Lever w/ #11 Rosette	 Padua Lever w/ #11 Rosette	Rosette options  #11  #12  #14  #15
 Petal Knob w/ #11 Rosette	 Parma Knob w/ #12 Rosette	 Octagon Knob w/ #15 Rosette	Finish options  Flat Black Bronze FB  Medium Bronze MB	

## Emtek Door Handing Chart

The handing of a door is always determined from the outside.

- The outside of an exterior door is the street or entrance side
- The outside of a room door is the hall side
- The outside of a closet door is the room or hall side
- The outside of a single communicating door is the side from which the hinges are not visible when the door is closed

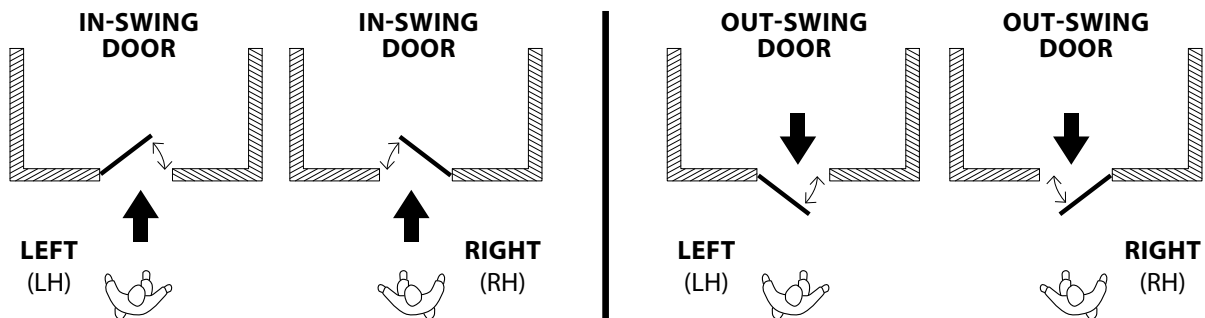

# EMTEK LOCKS

2

**All Special Order  
Lead time 7-10  
business days\***

## ELECTRONIC LOCKSETS - EMPOWERED KEYPAD ENTRYSETS

- SMART lock upgrade available - Secure from anywhere using the Yale access app
- Complete set includes both 2-3/8 and 2-3/4" latches, strikes and 4 AA batteries
- Standard door prep 2-1/8" bore. Fits standard door thickness of 1-3/4". Specify if thicker up to 2-1/4"
- Choose any Brass lever or knob for interior - Handing required if lever used
- EMPOWERED deadbolt only available with square corner latch face plate

**Standard sets List \$ 734, works with Yale Access List \$ 946**



Baden Grip  
w/ Int. Helios Lever



Ares Grip  
w/ Int. Aston Lever



Franklin Grip  
w/ Int. Turino Lever



Hamden Grip  
w/ Int. Merrimack Lever



EMPowered Touchscreen  
Keypad Deadbolt

List \$ 432

Smart Keypad Deadbolt  
(works w/ Yale Access)

List \$ 645

Fits door thickness  
of 1-1/2" to 2-1/4".

### Finish options



Oil R Bronze  
US10B



Polished Nickel  
US14



Satin Nickel  
US15



Flat Black  
US19



Pol Chrome  
US26

## ELECTRONIC LOCKSETS - KEYPAD ENTRYSETS

- Fits standard door thickness of 1-3/4". Specify if thicker.
- Standard door prep 2-1/8" bore. Standard latch is for 2-3/8" backset. Specify 2-3/4" backset if required.
- Complete set includes latch, strike plate and a 9-volt battery
- Factory programmed with 2 unique, 4-digit secure user codes
- Can be programmed with up to 20 user codes of your choice

For Technical Specs  
and Installation  
Instructions on  
Emtek products,  
visit emtek.com and  
go to SUPPORT.



List  
\$ 656

EMTouch  
Keypad Entry Set



List  
\$ 656

EMTouch Classic Style  
Keypad Entry Set



List  
\$ 616

Modern Style  
Keypad Entry Set

Available in the  
above finishes plus  
Satin Brass (US4)



Satin Brass  
US4



Sandcast Bronze  
Style Keypad  
Entry Set

List  
\$ 787



Flat Black  
Bronze (FB)



Medium  
Bronze (MB)

**All Special Order**  
 Lead time 7-10  
 business days\*

# EMTEK LOCKS

2

## ELECTRONIC LOCKSETS - DEADBOLTS

- Schlage C Keyway. Std Door Prep and Installation
- Solid Brass Cylinder, Housing, Collar, Thumbturn and Rosette, Hardened Steel Bolt
- Heavy Gauge Steel Understrike and Brass Trim Strike shipped with every deadbolt
- Std door thickness of 1-3/4". Specify if thicker.
- Std door prep 2-1/8" bore. Std latch is for 2-3/8" backset. Specify 2-3/4" backset if required.
- Set includes latch, strike plate and a 9-volt battery



EmTouch List  
 E3020 \$ 359

Avail in US4, US10B,  
 US14, US15, US19, US26



EmTouch Classic List  
 E3002 \$ 359

Avail in US3,  
 US10B, US15



Modern List  
 E1020 \$ 318

Avail in US10B, US15,  
 US19, US26



Classic List  
 E1000 \$ 279

Avail in US3,  
 US10B, US15

### Finish options



Polished Brass  
 US3



Satin Brass  
 US4



Oil R Bronze  
 US10B



Polished Nickel  
 US14



Satin Nickel  
 US15



Flat Black  
 US19



Pol Chrome  
 US26

## THUMBTURN PRIVACY BOLTS

- Mix-Match Style & Finish:  
 4 Thumbturn & Rosette designs in 10 Finishes
- Locked/unlocked indicator available on Double rosette styles
- Complete set includes latch, strike plate, and emergency release tool
- Std latch is for 2-3/8" backset. Specify 2-3/4" backset if required
- Fits door thickness 1-3/8" - 1-3/4". Specify if thicker.
- Can be used with any Brass passage set



**8581US19.RECUS4**  
 Square/Single Rosette  
 Flat Black Finish  
 Rectangular (REC) Thumbturn  
 Satin Brass finish



**8682US4.ARCUS4**  
 Disk/Double Rosette  
 Arched (ARC) Thumbturn  
 Satin Brass finish



**8383US15.RESUS15**  
 Wilshire/DbL Rosette w/ Ind.  
 Rect. Step (RES) Thumbturn  
 Satin Nickel finish

Choose Rosette style (e.g. Disk/Single Rosette),  
 Thumbturn style, and Finish.

Rosette	Description	Code	List/ea
Disk	Single Rosette	8681	\$ 54
	Double Rosette	8682	70
	DbL Rosette w/ Indicator	8683	77
Square	Single Rosette	8581	\$ 54
	Double Rosette	8582	70
	DbL Rosette w/ Indicator	8583	77
Watford	Single Rosette	8481	\$ 54
	Double Rosette	8482	70
	DbL Rosette w/ Indicator	8483	77
Wilshire	Single Rosette	8381	\$ 54
	Double Rosette	8382	70
	DbL Rosette w/ Indicator	8383	77

# EMTEK DEADBOLTS

2

## EMTEK DEADBOLTS

- Schlage C Keyway. Standard Door Prep and Installation
- Solid Brass Cylinder, Housing, Collar, Thumbturn and Rosette
- Hardened Steel Bolt
- Heavy Gauge Steel Understrike and Brass Trim Strike shipped with every deadbolt
- Standard door thickness of 1-3/4". Specify if thicker.
- Standard latch is for 2-3/8" backset. Specify 2-3/4" if required.

**All Special Order  
 Lead time 7-10  
 business days\***

**Deadbolts - Brass** Single Cylinder List \$ 98, **EMPowered Upgrade (works w/ Yale Access)** List \$ 641



Above deadbolts not available in US3, US7, US15A.



\*\* Only available in US10B  
 US15, US19, and US3NL

### Finish options





# EMTEK DEADBOLTS

## EMTEK DEADBOLTS *Cont.*

**All Special Order**  
**Lead time 7-10**  
**business days\***

Finish options



Flat Black  
Bronze  
FB



Medium  
Bronze  
MB



Tumbled  
White Bronze  
TWB

2

### Deadbolts - Sandcast Bronze Single Cylinder List \$ 110

Regular



8450

#1 w/ Flap



8457

#3 w/ Flap



8465

Rustic Modern  
Rectangular w/ Flap



8477

Ridgemont w/ Flap



8476

### Deadbolts - Tuscany Bronze Single Cylinder List \$ 110

Tuscany



8456

Classic Tuscany



8471

Octagon



8460

Tuscany #11



8472

Tuscany #14



8473

Tuscany only available in FB and MB.

### Deadbolts - Stainless Steel - Brushed Stainless Steel Finish Single Cylinder List \$ 98

SS Modern Disc



S50004

SS Round



S50001

SS Square



S50003

For Technical Specs  
and Installation  
Instructions on  
Emtek products,  
visit [emtek.com](http://emtek.com) and  
go to SUPPORT.

# EMTEK HANDLESETS

2

## EMTEK BRASS MORTISE ENTRANCE HANDLESETS

- 2-1/2" and 2-3/4" Backsets, Hanging Required
- Choose F13 or F20 Mortise Lock Box function (F20 function includes stop/release button)
- Standard Mortise Door Prep ANSI A115.1
- Solid Forged Brass Trim
- Schlage C Keyway
- Inside lever retracts latch and deadbolt simultaneously
- Locks for In-Swing Doors standard, for Out-Swing doors, please specify
- All prices are LIST for Active Entry Sets



**All Special Order**  
 Lead time 7-10 business days\*



Order any brass lever or knob for the interior.

Mormont



\$ 844

Lugano



\$ 920

Brisbane



\$ 844

Adelaide



\$ 920

Artemis



\$ 844

Hera



\$ 920

Transitional Heritage



\$ 844

Harrison



\$ 844

Middleton



\$ 920

## EMTEK SANDCAST BRONZE MORTISE ENTRANCE HANDLESETS

- Available in 3 finishes: Flat Black (FB), Medium Bronze (MB), Tumbled Wht Bronze (TWB)



Order any Sandcast Bronze lever or knob, or Crystal & Porcelain knob for the interior.

Sonoma



\$ 935

Longmont



\$ 1013

Rustic Modern Rectangular



\$ 935

Cheyenne



\$ 935

Topeka



\$ 1013

More styles available - check out emtek.com



# EMTEK HANDLESETS

2

**All Special Order  
 Lead time 7-10  
 business days\***

## EMTEK BRASS TUBULAR ENTRANCE HANDLESETS

- EMPowered Upgrade available - fits door thickness up to 2-1/4"
- Standard 2-1/8" Door Prep, Fits std door thickness of 1-3/4". Specify if thicker.
- Solid Forged Brass Trim, Schlage C Keyway
- Choose any Brass Lever or Knob for interior, Handing required if lever
- Interconnect Device available on most designs (specify handing)
- Many Finishes available, Unlacquered Brass (US3NL) available for an upcharge

All prices are LIST for Single Cylinder, Double Cylinder and Dummy Sets

Baden



\$ 396

Davos\*\*



\$ 455

Lausanne



\$ 534

Ares



\$ 396

Apollo



\$ 455

Orion



\$ 534

\*\* Available in  
 Stainless Steel

Urban Modern  
 Sectional



\$ 396

Transitional Heritage  
 Sectional



\$ 396

Transitional Heritage  
 Monolithic



\$ 455

Adams



\$ 455

Jefferson



\$ 534

Hamden



\$ 396

Wilshire



\$ 455

Melrose



\$ 534

Nashville



\$ 396

Richmond



\$ 455

Wilmington



\$ 534

For Technical Specs  
 and Installation  
 Instructions on  
 Emtek products,  
 visit [emtek.com](http://emtek.com) and  
 go to SUPPORT.

Saratoga



\$ 396

Marietta



\$ 455

Knoxville



\$ 396

Orleans



\$ 455

Ribbon & Reed



\$ 455

Imperial



\$ 534

Arts & Crafts



\$ 455

Arts & Crafts  
 Full Length



\$ 534

# EMTEK HANDLESETS

2

## EMTEK SANDCAST BRONZE TUBULAR ENTRANCE HANDLESETS

- Standard 2-1/8" Door Prep, Fits std door thickness of 1-3/4". Specify if thicker.
- Solid Forged Brass Trim, Schlage C Keyway
- Choose any Sandcast Bronze Lever or Knob for interior, Handing required if lever
- Interconnect Device available on most designs (specify handing)
- Available finishes: Flat Black Bronze (FB), Medium Bronze (MB), or Tumbled White Bronze (TWB)

**All Special Order  
 Lead time 7-10  
 business days\***

For Technical Specs and Installation Instructions on Emtek products, visit [emtek.com](http://emtek.com) and go to SUPPORT.

All prices are LIST for Single Cylinder, Double Cylinder and Dummy Sets

Rustic Modern  
 Rectangular  
 Sectional



\$ 549

Rustic Modern  
 Rectangular  
 Monolithic



\$ 611

Rustic Modern  
 Rectangular  
 Full Length



\$ 686

Ridgemont



\$ 549

Logan



\$ 611

Brighton



\$ 686

Rectangular  
 Sectional



\$ 549

Rectangular  
 Monolithic



\$ 611

Rectangular  
 Full Length



\$ 686

Denver



\$ 549

Remington



\$ 611

Greeley



\$ 686

### LOST WAX BRONZE

Available in Flat Black (FB) and Medium Bronze (MB)

Tuscany  
 Sectional



\$ 549

Tuscany  
 Monolithic



\$ 611

### WROUGHT STEEL

Available in Flat Black Steel (FBS) and Satin Steel (SWS)

Sectional  
 San Carlos Grip



\$ 396

Sectional  
 Normandy Grip



\$ 396

Monolithic  
 San Carlos Grip



\$ 455

Monolithic  
 Normandy Grip



\$ 455



## ROCKY MOUNTAIN LOCKS

### ROCKY MOUNTAIN HARDWARE - 8-10 week lead time

All finishes priced the same. For additional Knob, Lever and Handle Set styles, see the next pages or visit [rockymountainhardware.com](http://rockymountainhardware.com)

#### Available Finishes:

Silicon Bronze Light (BL), Silicon Bronze Medium (BM), Silicon Bronze Dark (BD), Silicon Bronze Rust (BR), Silicon Bronze Brushed (BBB), Silicon Bronze High Polished (BHP), Bronze Dark Lustre (BDL), White Bronze High Polished (WHP), White Bronze Light (WL), White Bronze Medium (WM), White Bronze Dark (WD), White Bronze Brushed (WBB).



2

### ENTRY AND FULL DUMMY MORTISE LOCKS

Entries come with Baldwin cylinder and mortise box. Specify Handing and Door thickness.



E463 Esc.  
with L103  
Lever

Example  
Lock  
Combos



E721 Esc.  
with L110  
Lever

G542 Esc. w/ G618 grip  
3-1/2"x 19-5/8" G542/G618  
3-1/2"x 13" E463/L103  
Complete Entry \$ 1726  
Full Dummy 1051

G770 Esc. w/ G603 grip  
3-1/2"x 20" G770/G603  
2-1/2"x 11" E721/L110  
Complete Entry \$ 1731  
Full Dummy 1059



E431 Esc.  
with K203  
Knob

Example  
Lock  
Combos



E728 Esc.  
with L125  
Lever

G641 Esc. w/ G606 grip  
2-3/4"x 18" G641/G606  
2-1/2"x 10" E431/L105  
Complete Entry \$ 1645  
Full Dummy 973

G572 Esc. w/ G618 grip  
3"x 20" G572/G618  
3"x 13" E728/L125  
Complete Entry \$ 1726  
Full Dummy 1051

### COMPLETE PASSAGE SPRING LATCH SETS

Example Passage Sets



2-5/8"x 2-5/8" E416 \$ 577

E416 Esc.  
w/ L109 Lever



3-1/4 dia. E418 \$ 599

E418 Esc.  
w/ L125 Lever

### COMPLETE PRIVACY SPRING LATCH SETS



Example Privacy Sets

E460/E460 Esc.  
3-1/2"x 13"  
w/ K205 Knob

\$ 877

### COMPLETE PRIVACY MORTISE BOLT SETS



Example Sets

IP716 Turnpiece  
w/emergency  
release trim  
2-1/2"x 3-3/4"

E701 Esc.  
L110 Lever

IP716 Turnpiece w/E701 Esc. \$ 941  
Includes Emergency Release Trim

Esc: Escutcheon

**ROCKY MOUNTAIN**  
 HARDWARE

2

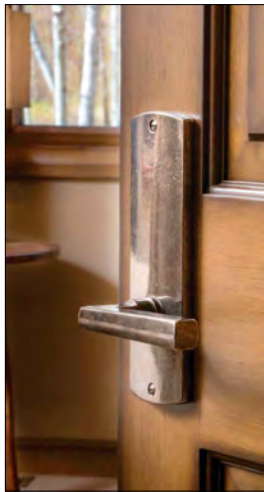

**ROCKY MOUNTAIN HARDWARE MORTISE LOCKS**

Rocky Mountain Hardware products are made of solid bronze. Hand applied patinas enhance the hues of the bronze creating an aged appearance. Over time, touch and climate work with the bronze and the patina to create a unique finish. Silicon bronze contains copper, silicon and zinc and is a coppery gold color. White bronze is composed of copper, manganese, nickel and zinc producing a silver color.



**All Special Order,  
 8-10 Week  
 Lead Time**

In addition to the two bronze choices and twelve patina options, Rocky Mountain Hardware is designed to be freely interchangeable. This allows for countless arrangements of escutcheons with levers, knobs, rings or grips. A variety of settings and styles can be effortlessly combined. Entries work with Baldwin cylinders and mortise locks. The following is a small sampling of the many mortise handle set configurations that are available:





## ROCKY MOUNTAIN LOCKS

### ROCKY MOUNTAIN HARDWARE KNOBS & LEVERS

These solid bronze levers and knobs are available in all of the Rocky Mountain patina finishes. All levers and knobs can be used on either interior or exterior Rocky Mountain locksets.

L = Overall Length

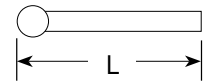

2



L111  
TWIG LEVER  
L = 4.81"



L118  
FRENCH TWIST LEVER  
L = 4.81"



L126  
TRIPLE TWIST LEVER  
L = 4.65"



L123  
OLD WORLD LEVER  
L = 5.60"



L102  
SQUIRREL TAIL LEVER  
L = 4.19"



L106  
TALON LEVER  
L = 5"



L140  
HARRINGTON LEVER  
L = 4.44"



L127  
SCROLL LEVER  
L = 3.81"



L135  
OLYMPUS LEVER  
L = 4.88"



L125  
CLASSIC SCROLL LEVER  
L = 5.16"



L108  
TUBE LEVER  
L = 4.81"



L101  
LONGHORN LEVER  
L = 5.61"



L110  
CLASSIC LEVER  
L = 5.09"



L121  
ROCK CREEK LEVER  
L = 4.66"



L105  
BEAVER TAIL LEVER  
L = 4.81"



L130  
MONARCH LEVER  
L = 4.92"



L117  
FRENCH LEVER  
L = 4.43"



L104  
HOOK LEVER  
L = 3.84"



L107  
SLUGGER LEVER  
L = 4.28"



L103  
CHUB LEVER  
L = 4.06"



L109  
LEGACY LEVER  
L = 4.13"



K201  
MUSHROOM  
KNOB  
Dia: 2-1/8"  
Proj: 2-3/16"



K251  
ROSWELL  
KNOB  
Dia: 2-7/16"  
Proj: 1-7/8"



K202  
HITCH KNOB  
Dia: 2-1/4"  
Proj: 3-1/4"



K204  
EGG KNOB  
2-1/2" x 1-9/16"  
Proj: 2-7/16"



K203  
POTATO KNOB  
2-3/4" x 1-3/4"  
Proj: 2-3/16"



K205  
BAKER KNOB  
3-1/8" x 1-13/16"  
Proj: 2-3/16"

## ROCKY MOUNTAIN

# RMH EXPRESS

2

Rocky Mountain Express - Solid Bronze hardware and accessories for projects on a tighter timeline.

- Ships within 10 business days
- Includes select door hardware, handle options and accessories - no substitutions
- Door hardware available in Entry, Privacy, Passage or dummy functions with standard backsets and door thickness
- Choice of 10 finish options



### Door Hardware



ARCHED PASSAGE SET  
 2-1/2" X 3-3/4" (EB70)  
 SMALL POTATO KNOB (KB50)  
 SILICON BRONZE RUST



ARCHED PASSAGE SET  
 2-1/2" X 6-1/2" (EB75)  
 BEAVER TAIL LEVER (L105)  
 SILICON BRONZE MEDIUM



RECTANGULAR PASSAGE SET  
 2-1/2" X 3-3/4" (EB50)  
 SMALL SQUASH KNOB (KB40)  
 WHITE BRONZE MEDIUM



RECTANGULAR PASSAGE SET  
 2-1/2" X 6-1/2" (EB55)  
 RAIL LEVER (L261)  
 SILICON BRONZE DARK



CURVED ENTRY SET  
 2-1/2" X 13" (E558/E557)  
 HANDLE: REED LEVER (L304)  
 SILICON BRONZE LIGHT



CURVED PASSAGE SET  
 2-1/2" X 6-1/2" (EB85)  
 LUNA DOOR KNOB (K207)  
 WHITE BRONZE DARK



STEPPED PASSAGE SET  
 2-1/2" X 3-3/4" (EB40)  
 SMALL RAIL LEVER (LB61)  
 WHITE BRONZE LIGHT



RECTANGULAR ENTRY SET  
 2-1/2" X 13" (E438/E437)  
 SQUASH KNOB (K268)  
 SILICON BRONZE DARK



CURVED PRIVACY SET  
 2-1/2" X 3-3/4" (EB80)  
 SMALL OLYMPUS LEVER (LB60)  
 SILICON BRONZE BRUSHED



METRO PASSAGE SET  
 2-1/2" X 6-1/2" (EB25)  
 OLYMPUS LEVER (L135)  
 WHITE BRONZE BRUSHED



STEPPED PRIVACY SET  
 2-1/2" X 6-1/2" (EB45)  
 REED LEVER (L304)  
 SILICON BRONZE DARK LUSTRE



ARCHED ENTRY SET  
 2-1/2" X 13" (E738/E737)  
 BEAVER TAIL LEVER (L105)  
 WHITE BRONZE LIGHT



# ROCKY MOUNTAIN

# RMH EXPRESS *Continued*

## Deadbolts



ARCHED DEADBOLT  
2-1/2" X 3-3/4"  
DB508  
SILICON BRONZE RUST



CURVED DEADBOLT  
2-1/2" X 3-3/8"  
DB511  
SILICON BRONZE BRUSHED



METRO DEADBOLT  
2-1/2" X 3-1/4"  
DB250  
WHITE BRONZE BRUSHED



RECTANGULAR DEADBOLT  
2-1/2" X 3"  
DB507  
WHITE BRONZE MEDIUM



STEPPED DEADBOLT  
2-1/2" X 3-1/8"  
DB312  
SILICON BRONZE DARK LUSTRE

## Lever Options



SMALL BEAVER  
TAIL LEVER  
1-1/8" X 4-1/8"  
LB50



SMALL  
OLYMPUS LEVER  
7/16" X 3-9/16"  
LB60



SMALL RAIL  
LEVER  
3/4" X 3-1/2"  
LB61



SMALL REED  
LEVER  
3/4" X 3-1/2"  
LB30



BEAVER  
TAIL LEVER  
1-3/8" X 4-7/8"  
L105



OLYMPUS  
LEVER  
1/2" X 4-3/4"  
L135



RAIL  
LEVER  
13/16" X 4-1/4"  
L261



REED  
LEVER  
3/4" X 4"  
L304

## Knob Options



SMALL LUNA  
KNOB  
2-3/16" ROUND  
KB60



SMALL POTATO  
KNOB  
1-1/2" X 2-5/16"  
KB50



SMALL SQUASH  
KNOB  
1-1/2" X 2-1/2"  
KB40



LUNA  
KNOB  
2-1/2" ROUND  
K207



POTATO  
KNOB  
1-3/4" X 2-3/4"  
K203



SQUASH  
KNOB  
1-3/4" X 2-3/4"  
K268

## Misc Door Hardware

### Hinges



HINGE: 3-1/2" X 3-1/2"  
HNG3.5B w/  
BT50 BALL CAP



HINGE: 4" X 4"  
HNG4B w/  
XT50 STANDARD CAP



HINGE: 4-1/2" X 4-1/2"  
HNG4.5B w/  
AT50 ACORN CAP

### Flush Pull



RECTANGULAR FLUSH PULL  
2-1/4" X 6"  
FP206

## Cap Options



STANDARD  
FINIAL CAP XT50  
1/2" BARREL



BALL  
FINIAL CAP BT50  
1/2" BARREL



ACORN  
FINIAL CAP AT50  
1/2" BARREL

## Door Stop



SHORT BASEBOARD  
DOOR STOP  
3-7/16"  
DS101



## ROCKY MOUNTAIN LOCKS

### ROCKY MOUNTAIN HARDWARE BUILDERS SERIES

2

Solid bronze architectural hardware. In their Builders Series, Rocky Mountain has combined its traditional custom process with a streamlined production technique. This results in a more competitively priced product without compromising the exceptional Rocky Mountain quality.

The Builder Series offers eight escutcheons that can be combined with a choice of two knobs and two levers. All Rocky Mountain Hardware finishes are available. Special Order, 8-10 week lead time.

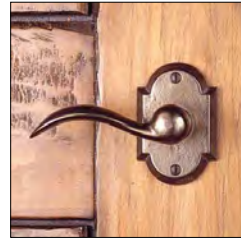

#### Price List

All finishes are priced the same. Escutcheon determines price. (Choice of Knob or Lever does not effect price.)

#### Escutcheons: EB50, EB70, EB40 and EB80

Single Dummy	\$ 117
Full Dummy	234
Passage	315
Privacy	325

#### Escutcheons: EB55, EB75, EB45 and EB85

Single Dummy	\$ 131
Full Dummy	262
Passage	344
Privacy	354

 EB50/KB50 Rectangular Escutcheon 2-1/2" x 3-3/4"	 EB55/LB50 Rectangular Escutcheon 2-1/2" x 6-1/2"	 EB75/KB50 Arched Escutcheon 2-1/2" x 6-1/2"	 EB70/LB50 Arched Escutcheon 2-1/2" x 3-3/4"
 EB40/KB60 Stepped Escutcheon 2-1/2" x 3-3/4"	 EB45/LB60 Stepped Escutcheon 2-1/2" x 6-1/2"	 EB85/KB60 Curved Escutcheon 2-1/2" x 6-1/2"	 EB80/LB60 Curved Escutcheon 2-1/2" x 3-3/4"
 KB50 Small Potato Knob 1-1/2" x 2-5/16"	 LB50 Small Beaver Tail Lever 4-1/4" O.A.Length	 KB60 Small Luna Knob 2-3/16" dia.	 LB50 Small Olympus Lever 3-7/8" O.A.Length

### BUILDERS SERIES PLAIN BEARING EXTRUDED HINGES

Available in all finishes.  
Price includes hinge  
and any style finial cap.

All Special Order.



HNG3.5B  
3.5" x 3.5"  
Shown with  
Ball Finial  
\$ 119/ea



HNG4B  
4" x 4"  
Shown with  
Standard  
Finial  
\$ 130/ea



HNG4.5B  
4.5" x 4.5"  
Shown with  
Acorn Finial  
\$ 143/ea





## ROCKY MOUNTAIN DISPLAYS

### ROCKY MOUNTAIN DISPLAY AND FINISH BOARDS

**RMB1 - 18 x 30 Board \$ 650 Net**

**RMB2 - 18 x 30 Board \$ 590 Net**



**Note:**  
 Date the back of all  
 Finish Boards  
 upon  
 receiving.  
  
 The finishes  
 change over  
 time.

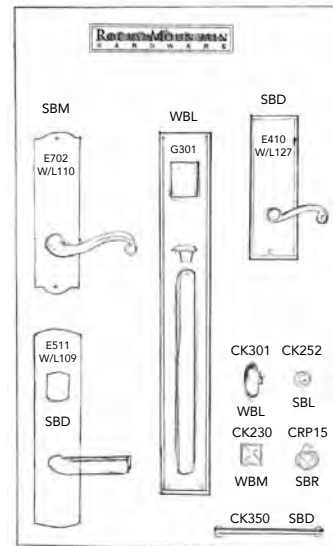
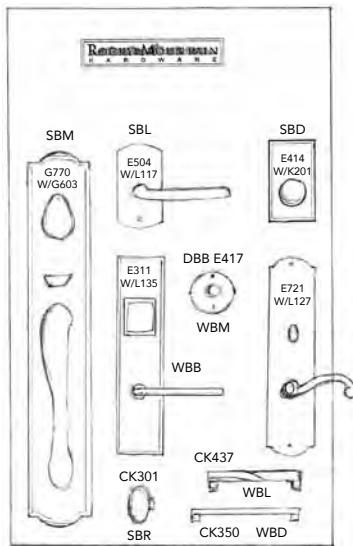

### ROCKY MOUNTAIN FINISH BOARD

Shows 12 finishes on a 3/4"  
 Thick Mahogany Wall Board.

Code Net/ea  
 PATINA BOARD \$ 165



#### SILICON BRONZE

BL = Light  
 BM = Medium  
 BD = Dark  
 BR = Rust  
 BBB = Brushed  
 BDL = Dark Lustre  
 BHP = High Polished

#### WHITE BRONZE

WL = Light  
 WM = Medium  
 WD = Dark  
 WBB = Brushed  
 WHP = High Polished



## FSB LOCKSETS

2



FSB offers a wide range of locksets from Mortise, Tubular latches and Deadbolts, Sliding Door Locks, Multi-Point, Lift & Slide and Glass Door Locks.

Over 40 different lever designs to choose from available in 12 standard finishes using either Stainless Steel, Bronze or Aluminum base metals. These lever designs, as well as all complementary trim can be used with a wide selection of American and European locking systems. **All Special Order.**



All FSB lever handles are made in Germany and are manufactured in compliance with the Americans with Disabilities Act (ADA).

### Trim Choices



#### Round/Oval Trim

- RA - 55mm Round
- RD - 65mm Round
- RJ - 55mm Round Flush
- RF - 70x32.5mm Oval
- RP - 30mm Min. Round

#### Square Trim

- RM - 55mm Square
- RS - 65mm Square

#### Escutcheons

- EC - 245x45mm Rounded
- ED - 245x45mm Square

L = Overall Length

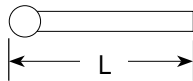

### Lever Choices

1001	1002	1003	1004	1005	1015
L = 5-5/16"	L = 5-19/32"	L = 5-1/8"	L = 5-3/16"	L = 5-1/32"	L = 4-13/16"
1016	1021	1023	1025	1031	1035
L = 5-5/8"	L = 5-3/8"	L = 5-5/16"	L = 5-1/4"	L = 5-19/32"	L = 5-3/8"
1045	1051	1053	1058	1070	1074
L = 5-3/16"	L = 5-5/32"	L = 5-9/16"	L = 5-3/64"	L = 5-23/32"	L = 6-11/32"

### Finishes

Premium Series: Stainless Steel / Bronze



6204  
Satin  
Stainless Steel



6205  
Polished  
Stainless Steel



7615  
Aged  
Bronze



7625  
Dark Oxidized  
Bronze

Elements Series: Aluminum base

#### Anodized Aluminum



0105  
Natural



0205  
Champagne  
Silver



0410  
Bronze



0510  
Med  
Bronze



0710  
Dark  
Bronze



0810  
Black

#### Powder Coated Aluminum



8120  
Black



8220  
White

































choose from  
100s of  
custom colors



## FSB LOCKSETS

2

### Lever Choices *cont.*

1075 	1076 	1078 	1080 	1088 	1093 
					
L = 5-3/16"	L = 5-3/8"	L = 5-5/16"	L = 5-5/32"	L = 5-5/16"	L = 5-3/8"
1102 	1106 	1107 	1108 	1119 	1134 
					
L = 5"	L = 4-11/16"	L = 5-11/32"	L = 5-5/16"	L = 5-7/8"	L = 5-3/16"
1144 	1146 	1147 	1160 	1163 	1164 
					
L = 5-5/32"	L = 5-19/32"	L = 5-3/16"	L = 5-29/32"	L = 4-15/16"	L = 5-7/16"
1176 	1177 	1178 	1183 	1241 	1242 
					
L = 5-1/2"	L = 5-3/8"	L = 5-5/16"	L = 6-11/32"	L = 5-1/2"	L = 5-1/2"
1244 	1251 	1267 	1271 	1285 	1289 
					
	L = 5-5/16"	L = 5-5/16"	L = 5-3/8"	L = 5-7/16"	L = 5-5/16"

### Entrance Sets

The FSB Entrance Set (ENT) is a Grade 1 mortise lock manufactured in the United States to meet the stringent demands of high-traffic applications.



Choose any FSB lever style for the interior side of your door. Available in Satin Stainless Steel (6204), these sets will truly make a statement on your front door.

#### Set Includes the following:

- 1 Ext. Escutcheon w/ Paddle & Pull
- 1 Int. Escutcheon w/ Thumbturn
- 1 Interior Lever of your choice
- 1 Half Spindle
- 1 Mortise Lock
- 1 Mortise Cylinder
- 2 Screws

#### Exterior Pull Design Options



1035  1076  1251 

Satin Stainless Steel (6204)

#### Interior Trim Plate



Satin Stainless Steel (6204)  
or Black Anodized Aluminum (0810)

# OMNIA

# SOLID BRASS

## OMNIA INTERIOR KNOB & LEVER SETS

2

These solid cast brass knobs and levers will fit a 2-1/8" bore. For commercial and residential use. For commercial use, please specify at time of order. Supplied for 2-3/8" Backset and 1-3/8" thick door unless otherwise specified. Thru-bolted roses. Each set consists of two solid brass knobs or levers, concealed screw roses, latch, spindle, mounting screws, template and instructions. **All Special Order.**

### Rose Dimensions

Modern Rose: 2-9/16" Dia. x 3/8"

Traditional Rose: 2-1/2" Dia. x 9/16"

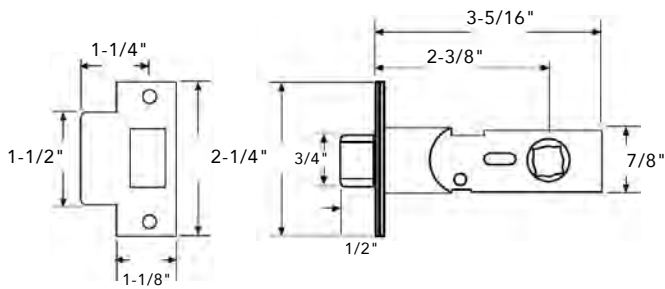

Strike Plate

Tubular Latch

### # 198 Knob Set

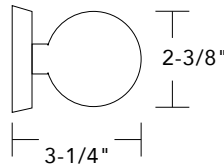

	Passage	Privacy	Sgl Dummy
198/60			
26, 26D	\$ 268	\$ 290	\$ 125

Also available in 2" (198/50) dia. knob

### # 368 Lever Set

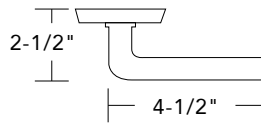

	Passage	Privacy	Sgl Dummy
368/00			
3	\$ 230	\$ 245	\$ 104
26,26D	240	256	109
10B	262	267	122
15	252	258	115

### # 915 Lever Set

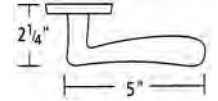

	Passage	Privacy	Sgl Dummy
915/00			
26, 26D	\$ 264	\$ 277	\$ 120
15	264	277	120

### # 890 Lever Set

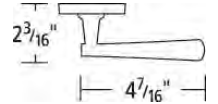

	Passage	Privacy	Sgl Dummy
890/00			
3	\$ 187	\$ 199	\$ 85
26,26D	206	232	88
10B	225	252	96
15	214	239	91

### # 904 Lever Set

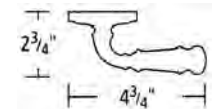

	Passage	Privacy	Sgl Dummy
904/00			
3	\$ 256	\$ 271	\$ 107
26,26D	276	283	109
10B	290	298	138
15	283	298	116

Shown with 2-5/8" dia. rose.

Also available in 1-3/4" (904/45), 2-3/16" (904/55) dia. roses.

### # 36 Lever Set

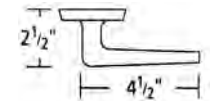

	Passage	Privacy	Sgl Dummy
36/00			
3	\$ 201	\$ 216	\$ 90
26,26D	216	226	95
10B	250	256	118
15	225	237	99

### Finish Codes

3:	Polished Brass	10B:	Oil Rubbed Bronze
26D:	Dull Chrome	26:	Polished Chrome
15:	Satin Nickel		

## OMNIA

## STAINLESS STEEL

### OMNIA LEVER LATCHSETS - All Special Order

- For commercial and residential use
- Will fit 2-1/8" bore, Rose dia: 2-7/16"
- 2-3/8" and 2-3/4" backsets available
- Supplied for 2-3/8" backset and 1-3/8" door thickness unless otherwise specified
- All lever latchsets are ADA approved
- Available in Passage, Privacy or Dummy; prices shown are Passage



32 - Pol. Stainless Steel, 32D - Brushed Stainless Steel

### OMNIA STAINLESS DEADBOLTS - All Special Order



Available in 2-3/8" or 2-3/4" backset. Fits in 2-1/8" standard bore.

Specify 1-3/8" or 1-3/4" door thickness. Available in 32D Finish.

Code	Finish	List
D9002	Brushed Stainless Steel	\$ 248

### OMNIA STAINLESS PRIVACY BOLTS

All Special Order

Available in 2-3/8" or 2-3/4" backset.

Faceplate: 2-1/4" x 1".

Strike: 2-3/4" dia. x 1-1/8".

Inside Rose: 2" dia. 3/8" depth.

Inside Turnpiece: 1-1/4" x 1-3/4" proj. Bolt: 5/8".



Code	Finish	List
6000	Brushed Stainless Steel	\$ 149

### OMNIA STAINLESS HANDLESET - URBAN

All Special Order



Urban with #12 Trim/ Lever

#### Backplate Dimensions:

5-1/2" center to center.

Exterior (Top plate) and Interior: 10-1/2" x 2-1/2" x 7/16"

Exterior (Bottom Rose): 2" square

#### Overall:

Exterior:

Length 16-3/4" x 2-3/8" proj.

Interior:

Length 10-1/2" x 2-5/8" proj.

Specify #12 or #43 Interior Lever. Brushed Stainless Finish.

Code	Panic Proof	Dummy Pair	Dummy Exterior	Dummy Interior
URBAN	\$ 628	322	232	101

## INTERIOR LOCKS

## VALLI & VALLI

2

### VALLI & VALLI LEVER SETS - Special Order

Available in a variety of lever styles and rosettes. For fine residential, light commercial or industrial int/ext doors.

- Door Range: 1-3/8" to 1-3/4" standard  
 Backset: 2-3/8" standard  
 Latch: 1/2" throw reversible latch with 1" x 2-1/4" square corner latch face for passage privacy; latches come with a T-strike: 2-3/4" x 1-1/8" and Lip: 1-1/4"  
 Function: Passage and privacy locksets or dummy levers. Specify door handing for dummy levers.  
 Mechanism: Cold rolled steel corrosion treated for normal atmospheric conditions.  
 Crossbore: 2-1/8"  
 Edge-Bore: 15-16"  
 Throw: 1/2"

- 15: Satin Nickel  
 26D: Satin Chrome  
 32D: Satin Stainless Steel

Code	Finish	Passage	Privacy	Dummy (each)
H416	32D	\$ 181	\$ 198	\$ 94
H1045	15	530	541	267
	26D	532	518	262
H1046	15	443	461	225
	26D	428	444	218
H1049	26D	495	520	251
H5008	32D	662	682	320
H5014	32D	373	383	185
H5017	32D	913	924	447

### All Special Order

#### H416 Garnet

Material: Stainless Steel

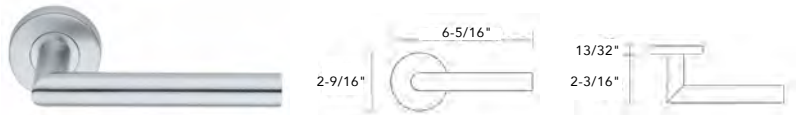

#### H1045 Bess

Material: Zinc

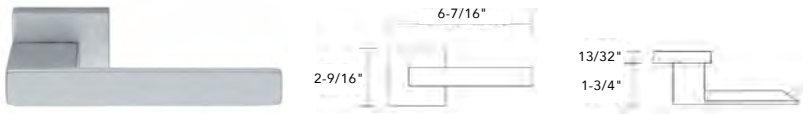

#### H1046 Nais

Material: Brass

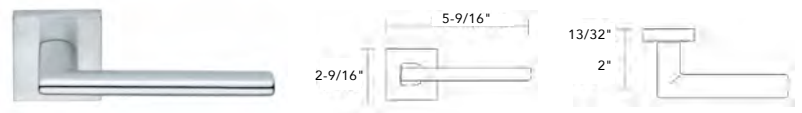

#### H1049 Divara

Material: Brass

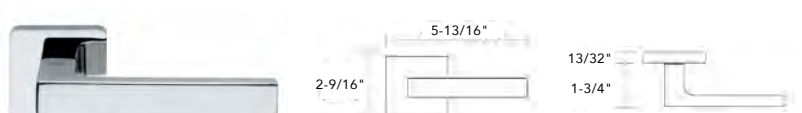

#### H5008 Himalaya

Material: Stainless Steel

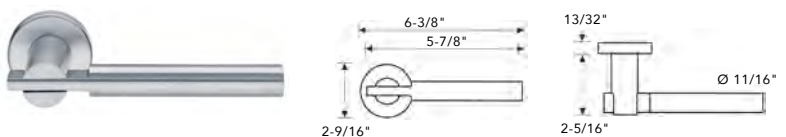

#### H5014 Bernina

Material: Stainless Steel

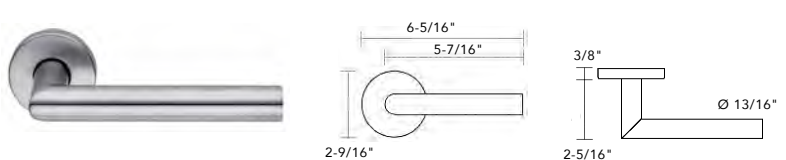

#### H5017 Gottardo

Material: Stainless Steel

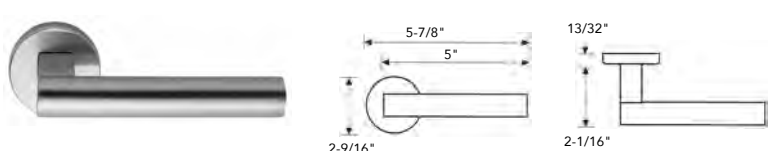

## INOX LOCKS



All Special Order

2

Residential ~ Commercial ~ European  
 Locks by Unison Hardware.

Go to: [www.unisonhardware.com](http://www.unisonhardware.com) for a more detailed product listing.



### European Lever Styles



GB Rose Grade 4



GA Rose Grade 3



LP Plate Grade 3



SP Plate Grade 3



SA Rose Grade 3



SG Rose Grade 3



OR Rose Grade 3



GC Rose Grade 2

### US Lever Styles



GT Series - Tubular



GS Series - Tubular



LA Series - Tubular



RA Series - Tubular



SE Series



SF Series - Tubular

### Deadbolts



RD



SD



GD



HD



CD



LD



## ACCURATE LOCK

### ACCURATE LOCK CUSTOM STRIKES

2

All Special Order

Accurate provides fast, high quality custom products.  
Items include:

- Custom wraps
- Custom cover plates
- Custom face plates
- Custom filler plates
- Custom strikes (mortise, full lip, "T", profile, roller, ball catch, cremone, angle and double lip)



### ACCURATE LOCK SLIDING DOOR LOCKS

All Special Order



2000 Sliding Door Lock

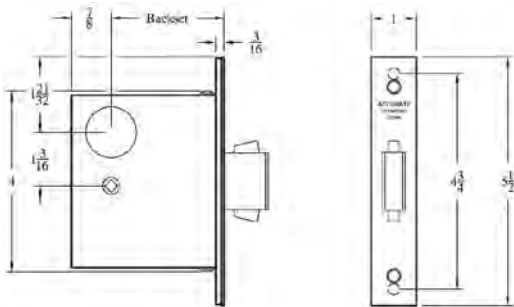

2002 Pocket Door Lock with Pull

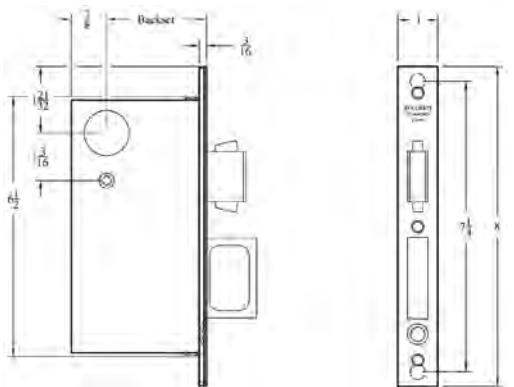

### ACCURATE LOCK MORTISE LOCKS

Used by Omnia, Rocky Mtn, FSB, Emtek and Schlage

For use with lever handles and knobs.

Cylinders and trim shown for illustration purposes only (supplied by others).

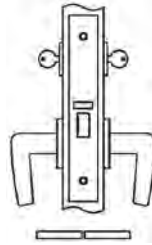

**8842**  
For doors 1-3/4" min (1-1/4" armour front)

**8742**  
For doors 1-3/8" min (1" armour front)  
Entrance or public restroom Lock  
(ANSI Series 1000-F09)

Latch bolt by lever either side unless outside lever is locked by Master Key from inside.  
When outside lever is locked, latch bolt by key outside and lever inside.  
Auxiliary latch deadlocks latch bolt.

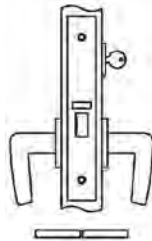

**8845**  
For doors 1-3/4" min (1-1/4" armour front)

**8745**  
For doors 1-3/8" min (1" armour front)  
Classroom Lock  
(ANSI Series 1000-F05)

Latch bolt by key outside and lever either side unless outside lever is locked by key.  
Auxiliary latch deadlocks latch bolt.

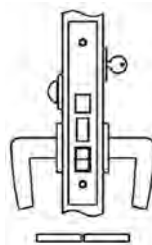

**8848**  
For doors 1-3/4" min (1-1/4" armour front)

**8748**  
For doors 1-3/8" min (1" armour front)  
Entrance or Apartment Lock  
(ANSI Series 1000-F12)

Latch bolt by key outside and lever either side unless outside lever is locked by toggle action stop.  
Dead bolt by key outside and turn piece inside.  
Turning inside lever retracts latch and dead bolt simultaneously.  
Outside lever remains locked until manually unlocked by toggle.

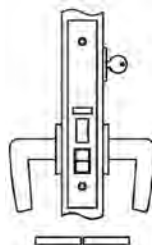

**8856**  
For doors 1-3/4" min (1-1/4" armour front)

**8756**  
For doors 1-3/8" min (1" armour front)  
Entrance or Office Lock  
(ANSI Series 1000-F04)

Latch bolt by key outside and lever either side unless outside lever is locked by toggle action stop.  
Auxiliary latch deadlocks latch bolt.

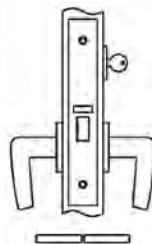

**8859**  
For doors 1-3/4" min (1-1/4" armour front)

**8759**  
For doors 1-3/8" min (1" armour front)  
Storeroom or Closet Lock  
(ANSI Series 1000-F07)

Latch by lever inside and key outside.  
Outside lever always RIGID.  
Auxiliary latch deadlocks latch bolt.





**BALDWIN RESERVE KNOB SETS**

**RESERVE**

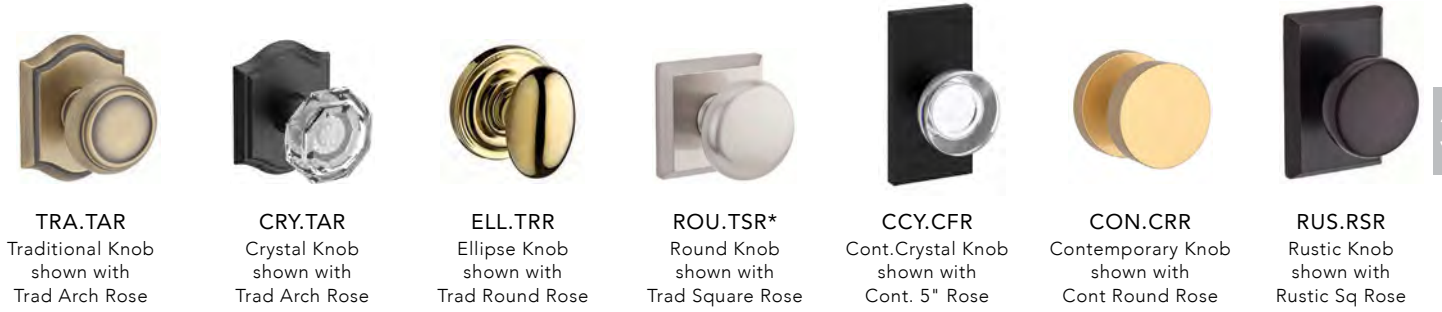

Choose Function	Style	Rose	Finish	List
(PS) Passage	CRY Crystal	TRR Traditional Round Rose	003 Polished Brass PVD	\$ 185
(PV) Privacy		TAR Traditional Arch Rose	044 Satin Brass PVD	
(FD) Full Dummy		TSR Traditional Square Rose	150 Satin Nickel	
(HD) Half Dummy			152 Matte Antique Nickel	
			112 Venetian Bronze	185
			260 Polished Chrome	\$ 92
			055 Polished Nickel PVD	
			190 Satin Black	
(EN) Entry	ELL Ellipse	TRR Traditional Round Rose	003 Polished Brass PVD	\$ 237
(PS) Passage	ROU Round*	TAR Traditional Arch Rose	044 Satin Brass PVD	\$ 151
(PV) Privacy		TSR Traditional Square Rose	150 Satin Nickel	
(FD) Full Dummy	TRA Traditional		152 Matte Antique Nickel	151
(HD) Half Dummy			112 Venetian Bronze	151
			260 Polished Chrome	
			055 Polished Nickel PVD	\$ 75
			190 Satin Black	
(EN) Entry	CON Contemporary	CFR Contemporary 5" Rose*	150 Satin Nickel	\$ 247
(PS) Passage			112 Venetian Bronze	\$ 187
(PV) Privacy		CRR Contemporary Round Rose	044 Satin Brass PVD	
(FD) Full Dummy			260 Polished Chrome	187
(HD) Half Dummy		CSR Contemporary Square Rose	055 Polished Nickel PVD	187
			190 Satin Black	\$ 93
(PS) Passage	CCY Contemporary Crystal	See Above Rose offering	See Above Finish offering	\$ 187
(PV) Privacy				\$ 187
(FD) Full Dummy				\$ 187
(HD) Half Dummy				\$ 93
(EN) Entry	RUS Rustic	RAR Rustic Arch Rose	481 Dark Bronze	\$ 256
(PS) Passage		RSR Rustic Square Rose	492 White Bronze	\$ 191
(PV) Privacy				191
(FD) Full Dummy				191
(HD) Half Dummy				\$ 95

Traditional Rose Options



TRR TAR TSR

Contemporary Rose Options



CFR CRR CSR

Rustic Rose Options



RAR RSR

Other roses available, depending on finish.

Entry knobs available with C-keyway pin and tumbler cylinder only.

\* Some combinations in stock, all else **SPECIAL ORDER**

RESERVE

BALDWIN RESERVE LEVER SETS



Traditional



**CUR.TRR\***  
Curve Lever shown with Traditional Round Rose



**FED.TSR**  
Federal Lever shown with Traditional Square Rose



**DEC.TAR**  
Decorative Lever shown with Traditional Arch Rose

3

Choose Function	Style	Handing*	Rose	Finish	List
(EN) Entry	CUR Curve*	R Right Hand	TRR Traditional Round Rose	003 Polished Brass PVD	\$ 237
(PS) Passage				044 Satin Brass PVD	
(PV) Privacy	DEC Decorative	L Left Hand	TAR Traditional Arch Rose	150 Satin Nickel	151
(FD) Full Dummy				152 Matte Antique Nickel	
(HD) Half Dummy	FED Federal	L Left Hand	TSR Traditional Square Rose	112 Venetian Bronze	151
				260 Polished Chrome	
				055 Polished Nickel PVD	\$ 75
				190 Satin Black	

Contemporary



**TUB.CRR**  
Tube Lever shown with Contemporary Round Rose



**SQU.CSR\***  
Square Lever shown with Contemporary Square Rose



**ARC.RAR\***  
Arch Lever shown with Rustic Arch Rose



**TAP.RSR**  
Taper Lever shown with Rustic Square Rose

Rustic

Choose Function	Style	Handing*	Rose	Finish	List
(EN) Entry	TUB Tube	R Right Hand	CRR Contemporary Round Rose	150 Satin Nickel	\$ 237
(PS) Passage				112 Venetian Bronze	
(PV) Privacy	SQU* Square	L Left Hand	CSR Contemporary Square Rose	044 Satin Brass PVD	151
(FD) Full Dummy				260 Polished Chrome	
(HD) Half Dummy				055 Polished Nickel PVD	151
				190 Satin Black	
(EN) Entry	ARC* Arch	R Right Hand	RAR Rustic Arch Rose	481 Dark Bronze	\$ 256
(PS) Passage				492 White Bronze	
(PV) Privacy	TAP Taper	L Left Hand	RSR Rustic Square Rose	492 White Bronze	191
(FD) Full Dummy					
(HD) Half Dummy					\$ 95

Traditional Rose Options



TRR TAR TSR

Contemporary Rose Options



CRR CSR

Rustic Rose Options



RAR RSR

Handing required for Half Dummy function and split style or split finish orders.

\* Some combinations in stock, all else **SPECIAL ORDER**



RESERVE

**BALDWIN RESERVE DEADBOLTS**

Traditional



**TRD\***  
 Traditional Round Deadbolt



**TAD**  
 Traditional Arch Deadbolt



**TSD\***  
 Traditional Square Deadbolt

Contemporary



**CRD\***  
 Contemporary Round Deadbolt



**CSD\***  
 Contemporary Square Deadbolt



**RSD**  
 Rustic Square Deadbolt



**RAD\***  
 Rustic Arch Deadbolt

3

Function	Style	Finish	List
(SC) Single Cylinder	TRD* Round	003 Polished Brass PVD	\$ 104
		044 Satin Brass PVD	
		150 Satin Nickel	
(DC) Double Cylinder	TAD Arch	152 Matte Antique Nickel	114
		112 Venetian Bronze	
		260 Polished Chrome	
(PT) Patio	TSD* Square	260 Polished Chrome	64
		055 Polished Nickel PVD	
		190 Satin Black	

Function	Style	Finish	List
(SC) Single Cylinder	CRD* Round	150 Satin Nickel	\$ 104
		112 Venetian Bronze	
		044 Satin Brass PVD	
(DC) Double Cylinder	CSD* Square	260 Polished Chrome	114
		055 Polished Nickel PVD	
		190 Satin Black	
(SC) Single Cylinder	RAD* Arch	481 Dark Bronze	\$ 121
		492 White Bronze	
		481 Dark Bronze	
(DC) Double Cylinder	RSD Square	492 White Bronze	132
(PT) Patio			67

**Deadbolt Dimensions**

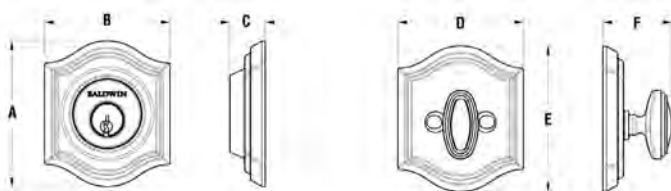

**Deadbolt**

	TRD	TSD	CRD	CSD	RAD
A	ø 2-3/5"	2-3/5"	ø 2-5/8"	2-9/16"	3-5/8"
B	N/A	2-3/5"	N/A	2-9/16"	2-11/16"
C	3/4"	3/4"	3/4"	3/4"	1-1/16"
D	ø 2-5/8"	2-5/8"	ø 2-5/8"	2-5/8"	2-11/16"
E	N/A	2-5/8"	N/A	2-5/8"	3-7/16"
F (SC)	1-7/16"	1-7/16"	1-7/16"	1-7/16"	1-7/16"
F (DC)	3/4"	3/4"	3/4"	3/4"	1-1/16"

**Deadbolt Specifications**

<b>Door Preparation</b>	2-1/8" Cross Bore. 1" edge bore for latch
<b>Door Thickness</b>	1-3/8 to 2" standard, Up to 2-1/2" doors optional through thick door option or service part kit
<b>Cylinder</b>	Baldwin C-Keyway standard. SmartKey® Re-key Technology optional
<b>Backset</b>	Adjustable 2-3/8 or 2-3/4
<b>Front &amp; Latch</b>	Square Corner Adjustable (SL) standard. Round Corner (RL), Drive In (DL), or 6 Way Adjustable (6L) optional
<b>Strike</b>	Square Corner strike standard
<b>Latch Bolt</b>	Deadbolt features 1" throw Brass bolt latch
<b>Handing</b>	Handing not required
<b>ANSI/BHMA</b>	Tested to exceed ANSI/BHMA Grade 2 security
<b>ADA</b>	N/A

\* Some combinations in stock, all else **SPECIAL ORDER**



RESERVE

**BALDWIN RESERVE TRADITIONAL HANDLESETS**



3



Choose Function	Style	Interior Knob or Lever	Handing	Rose	Finish	List
(SC) Single Cylinder	COL Columbus	ELL Ellipse	N/A	TRR Traditional Round Rose	003 Polished Brass PVD	\$ 409
(DC) Double Cylinder	NAP Napa*	ROU Round			150 Satin Nickel	
(FD) Full Dummy	WES Westcliff*	TRA Traditional	R Right Hand L Left Hand	TAR Traditional Arch Rose	152 Matte Antique Nickel	\$ 457
	CHE Chesapeake	CUR Curve			112 Venetian Bronze	
(EE) Emergency Egress	DEL Del Mar	FED Federal	R Right Hand L Left Hand	TSR Traditional Square Rose	260 Polished Chrome	\$ 482
	ELI Elizabeth	DEC Decorative			055 Polished Nickel PVD	
(FD) Full Dummy	NEW New Hampshire				190 Satin Black	

\*Thin door options available for 1-3/8" to 1-3/4" SC and DC

Additional interior styles available, depending on interior finish. Crystal knob not available for handleset interiors.

EE Int. Egress Options



SC/DC Rose Options



Interior Lever/Knob Options





RESERVE

**BALDWIN RESERVE CONTEMPORARY HANDLESETS**



LAJ  
La Jolla



MIA  
Miami



SEA  
Seattle



SAN  
Santa Cruz

3

Choose Function	Style	Interior Knob or Lever	Handing	Rose	Finish	List
(SC) Single Cylinder	LAJ La Jolla	CON Contemporary	N/A	CRR Contemporary Round Rose	150 Satin Nickel	\$ 409
(DC) Double Cylinder		TUB Tube	R Right Hand		112 Venetian Bronze	
(FD) Full Dummy		SQU Square	L Left Hand		044 Satin Brass PVD	
				260 Polished Chrome		
				055 Polished Nickel PVD		
				190 Satin Black		
(EE) Emergency Egress	MIA Miami	CON Contemporary	N/A	CQE Contemporary Square	150 Satin Nickel	\$ 482
(FD) Full Dummy	SEA Seattle	TUB Tube	R Right Hand		112 Venetian Bronze	
		SQU Square	L Left Hand		044 Satin Brass PVD	
				260 Polished Chrome		
				055 Polished Nickel PVD		
				190 Satin Black		
(EE) Emergency Egress	SAN Santa Cruz	CON Contemporary	N/A	CQE Contemporary Square	150 Satin Nickel	\$ 568
(FD) Full Dummy		TUB Tube	R Right Hand		112 Venetian Bronze	
		SQU Square	L Left Hand		044 Satin Brass PVD	
				260 Polished Chrome		
				055 Polished Nickel PVD		
				190 Satin Black		

EE Int. Egress Options



CQE

Contemporary Rose Options



CRR



CSR

Contemporary Knob/Levers



CON



TUB



SQU

RESERVE

**BALDWIN RESERVE RUSTIC HANDLESETS**



3



ADI  
Adirondack



KOD  
Kodiak



ELK  
Elkhorn



LON  
Longview

Choose Function	Style	Interior Knob or Lever	Handing	Rose	Finish	List
(SC) Single Cylinder	ADI Adirondack	RUS Rustic	N/A	RAR Rustic Arch Rose	481 Dark Bronze	\$ 514
(DC) Double Cylinder		ARC Arch	R Right Hand	RSR Rustic Square Rose	492 White Bronze	
(FD) Full Dummy		TAP Square	L Left Hand			
(EE) Emergency Egress	KOD Kodiak	RUS Rustic	N/A	RAE Rustic Arched	481 Dark Bronze	\$ 573
(FD) Full Dummy		ARC Arch	R Right Hand	SBE Square Bevel	492 White Bronze	
		TAP Square	L Left Hand			
(EE) Emergency Egress	ELK Elkhorn	RUS Rustic	N/A	RAE Rustic Arched	481 Dark Bronze	\$ 622
(FD) Full Dummy	LON Longview	ARC Arch	R Right Hand	SBE Square Bevel	492 White Bronze	
		TAP Square	L Left Hand			

EE Int. Egress Options



RAE SBE

Rustic Rose Options



RAR RSR

Rustic Knob/Lever Options



RUS ARC TAP



## BALDWIN ESTATE FINISHES



3

### Lifetime PVD Finishes



**003**

Lifetime (PVD)  
Polished Brass



**044**

Lifetime (PVD)  
Satin Brass



**055**

Lifetime (PVD)  
Polished Nickel



**056**

Lifetime (PVD)  
Satin Nickel



**076**

Lifetime (PVD)  
Graphite Nickel

### Living Finishes



**031**

Non-lacquered  
Brass



**033**

Vintage Brass

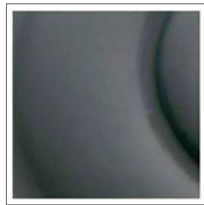

**102**

Oil Rubbed  
Bronze

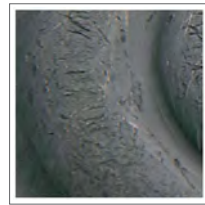

**402**

Distressed Oil  
Rubbed Bronze

#### Living Finishes.

Product finishes which are LIVING will vary over time. Not eligible for finish warranty.

### Standard (Non-Living) Finishes



**050**

Satin Brass  
& Black

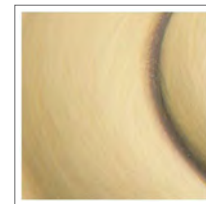

**060**

Satin Brass  
& Brown

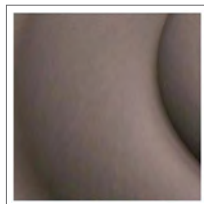

**112**

Venetian  
Bronze

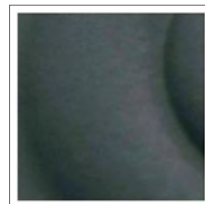

**190**

Satin Black



**260**

Polished  
Chrome

**Hand-Relieved Finish Variances.** Product finishes which are HAND RELIEVED may vary in luster, hue and appearance as a result of handcrafted variances in the final finishing step

150\* (Satin Nickel), 151 (Antique Nickel), 264 (Satin Chrome), and 452 (Distressed Antique Nickel now available while supplies last.

\*150 Satin Nickel still available in some Baldwin general hardware



**BALDWIN ESTATES PRE-CONFIGURED KNOBSETS**

Baldwin Quick Ship Passage, Privacy and Dummy sets ship from Baldwin in 2 weeks. Works with 1-3/8" and 1-3/4" thick doors. Passage and Privacy functions ship with a full lip strike and pre-bore adaptor. Quick ship is only available with 2-3/8" backset latch.



3

**5000 KNOB W/ 5048 ROSE**

	Code	Description	List
	5000.XXX.FD	Full Dummy	\$ 277
	5000.XXX.IDM	Half Dummy	134
	5000.XXX.PASS	Passage	352
	5000.XXX.PRIV	Privacy	352

**5023 KNOB W/ R016 ROSE**

	Code	Description	List
	5023.XXX.FD	Full Dummy	\$ 234
	5023.XXX.IDM	Half Dummy	115
	5023.XXX.PASS	Passage	314
	5023.XXX.PRIV	Privacy	314

**5011 KNOB W/ 5058 ROSE**

	Code	Description	List
	5011.XXX.FD	Full Dummy	\$ 283
	5011.XXX.IDM	Half Dummy	140
	5011.XXX.PASS	Passage	363
	5011.XXX.PRIV	Privacy	363

**5024 KNOB W/ R030 ROSE**

	Code	Description	List
	5024.XXX.FD	Full Dummy	\$ 234
	5024.XXX.IDM	Half Dummy	115
	5024.XXX.PASS	Passage	314
	5024.XXX.PRIV	Privacy	314

**5013 KNOB W/ 5021 ROSE**

	Code	Description	List
	5013.XXX.FD	Full Dummy	\$ 277
	5013.XXX.IDM	Half Dummy	134
	5013.XXX.PASS	Passage	352
	5013.XXX.PRIV	Privacy	352

**5025 KNOB W/ 5048 ROSE**

	Code	Description	List
	5025.XXX.FD	Full Dummy	\$ 243
	5025.XXX.IDM	Half Dummy	122
	5025.XXX.PASS	Passage	295
	5025.XXX.PRIV	Privacy	295

**5015 CLASSIC KNOB W/ 5048 ROSE**

	Code	Description	List
	5015.XXX.FD	Full Dummy	\$ 243
	5015.XXX.IDM	Half Dummy	122
	5015.XXX.PASS	Passage	295
	5015.XXX.PRIV	Privacy	295

**5030 KNOB W/ 5048 ROSE**

	Code	Description	List
	5030.XXX.FD	Full Dummy	\$ 277
	5030.XXX.IDM	Half Dummy	134
	5030.XXX.PASS	Passage	352
	5030.XXX.PRIV	Privacy	352











**5020 COLONIAL KNOB W/ 5048 ROSE**

	Code	Description	List
	5020.XXX.FD	Full Dummy	\$ 243
	5020.XXX.IDM	Half Dummy	122
	5020.XXX.PASS	Passage	295
	5020.XXX.PRIV	Privacy	295

**5041 KNOB W/ 5046 ROSE**

	Code	Description	List
	5041.XXX.FD	Full Dummy	\$ 234
	5041.XXX.IDM	Half Dummy	115
	5041.XXX.PASS	Passage	314
	5041.XXX.PRIV	Privacy	314

**Available Finishes**

									
003 Lifetime Polished Brass	031 Non-lacq. Brass	033 Vintage Brass	044 Lifetime Satin Brass	055 Lifetime Polished Nickel	056 Lifetime Satin Nickel	102 Oil R. Bronze	112 Venetian Bronze	190 Satin Black	260 Polished Chrome

\*Some finishes not available in certain styles



**BALDWIN ESTATES PRE-CONFIGURED KNOBSETS**



Baldwin Quick Ship Passage, Privacy and Dummy sets ship from Baldwin in 2 weeks. Works with 1-3/8" and 1-3/4" thick doors. Passage and Privacy functions ship with a full lip strike and pre-bore adaptor. Quick ship is only available with 2-3/8" backset latch.



3

**5055 KNOB W/ 5046 ROSE**

	Code	Description	List
	5055.XXX.FD	Full Dummy	\$ 277
	5055.XXX.IDM	Half Dummy	134
	5055.XXX.PASS	Passage	352
	5055.XXX.PRIV	Privacy	352

**5069 KNOB W/ 5076 ROSE**

	Code	Description	List
	5069.XXX.FD	Full Dummy	\$ 283
	5069.XXX.IDM	Half Dummy	140
	5069.XXX.PASS	Passage	363
	5069.XXX.PRIV	Privacy	363

**5057 KNOB W/ 5048 ROSE**

	Code	Description	List
	5057.XXX.FD	Full Dummy	\$ 277
	5057.XXX.IDM	Half Dummy	134
	5057.XXX.PASS	Passage	352
	5057.XXX.PRIV	Privacy	352

**5073 KNOB W/ 5046 ROSE**

	Code	Description	List
	5073.XXX.FD	Full Dummy	\$ 277
	5073.XXX.IDM	Half Dummy	134
	5073.XXX.PASS	Passage	352
	5073.XXX.PRIV	Privacy	352

**5064 KNOB W/ 5004 ROSE**

	Code	Description	List
	5064.XXX.FD	Full Dummy	\$ 277
	5064.XXX.IDM	Half Dummy	134
	5064.XXX.PASS	Passage	352
	5064.XXX.PRIV	Privacy	352

**5077 BETHPAGE KNOB W/ R027 ROSE**

	Code	Description	List
	5077.XXX.FD	Full Dummy	\$ 234
	5077.XXX.IDM	Half Dummy	115
	5077.XXX.PASS	Passage	314
	5077.XXX.PRIV	Privacy	314

**5066 KNOB W/ 5078 ROSE**

	Code	Description	List
	5066.XXX.FD	Full Dummy	\$ 283
	5066.XXX.IDM	Half Dummy	140
	5066.XXX.PASS	Passage	363
	5066.XXX.PRIV	Privacy	363

**5080 FILLMORE KNOB W/ 5048 ROSE**

	Code	Description	List
	5080.XXX.FD	Full Dummy	\$ 243
	5080.XXX.IDM	Half Dummy	122
	5080.XXX.PASS	Passage	295
	5080.XXX.PRIV	Privacy	295

**5068 KNOB W/ 5070 ROSE**

	Code	Description	List
	5068.XXX.FD	Full Dummy	\$ 283
	5068.XXX.IDM	Half Dummy	140
	5068.XXX.PASS	Passage	363
	5068.XXX.PRIV	Privacy	363

**K007 HOLLYWOOD HILLS KNOB W/ R050 ROSE**

	Code	Description	List
	K007.XXX.FD	Full Dummy	\$ 295
	K007.XXX.IDM	Half Dummy	147
	K007.XXX.PASS	Passage	375
	K007.XXX.PRIV	Privacy	375

**Available Finishes**



003  
Lifetime Polished Brass



031  
Non-lacq. Brass



033  
Vintage Brass



044  
Lifetime Satin Brass



055  
Lifetime Polished Nickel



056  
Lifetime Satin Nickel



102  
Oil R. Bronze



112  
Venetian Bronze



190  
Satin Black



260  
Polished Chrome

\*Some finishes not available in certain styles



## BALDWIN

### BALDWIN ESTATES PRE-CONFIGURED KNOB & LEVERSETS

Baldwin Quick Ship Passage, Privacy and Dummy sets ship from Baldwin in 2 weeks. Works with 1-3/8" and 1-3/4" thick doors. Passage and Privacy functions ship with a full lip strike and pre-bore adaptor. Quick ship is only available with 2-3/8" backset latch.



3

#### K008 HOLLYWOOD HILLS KNOB W/ R050 ROSE



Code	Description	List
K008.XXX.FD	Full Dummy	\$ 307
K008.XXX.IDM	Half Dummy	154
K008.XXX.PASS	Passage	387
K008.XXX.PRIV	Privacy	387

#### 5103 LEVER W/ 5048 ROSE



Code	Description	List
5103.XXX.FD	Full Dummy	\$ 270
5103.XXX.R/LDM	R/L Half Dummy	134
5103.XXX.PASS	Passage	350
5103.XXX.PRIV	Privacy	350

#### K009 HOLLYWOOD HILLS KNOB W/ R050 ROSE



Code	Description	List
K009.XXX.FD	Full Dummy	\$ 319
K009.XXX.IDM	Half Dummy	160
K009.XXX.PASS	Passage	399
K009.XXX.PRIV	Privacy	399

#### 5104 LEVER W/ 5004 ROSE



Code	Description	List
5104.XXX.FD	Full Dummy	\$ 270
5104.XXX.R/LDM	R/L Half Dummy	134
5104.XXX.PASS	Passage	350
5104.XXX.PRIV	Privacy	350

#### K012 KNOB W/ 5078 ROSE



Code	Description	List
K012.XXX.FD	Full Dummy	\$ 295
K012.XXX.IDM	Half Dummy	147
K012.XXX.PASS	Passage	375
K012.XXX.PRIV	Privacy	375

#### 5105 LEVER W/ 5046 ROSE



Code	Description	List
5105.XXX.FD	Full Dummy	\$ 270
5105.XXX.R/LDM	R/L Half Dummy	134
5105.XXX.PASS	Passage	350
5105.XXX.PRIV	Privacy	350

#### 5106 LEVER W/ 5048 ROSE



Code	Description	List
5106.XXX.FD	Full Dummy	\$ 270
5106.XXX.R/LDM	R/L Half Dummy	134
5106.XXX.PASS	Passage	350
5106.XXX.PRIV	Privacy	350

#### 5108 LEVER W/ 5048 ROSE



Code	Description	List
5108.XXX.FD	Full Dummy	\$ 270
5108.XXX.R/LDM	R/L Half Dummy	134
5108.XXX.PASS	Passage	350
5108.XXX.PRIV	Privacy	350

#### Available Finishes



- 003  
Lifetime Polished Brass
- 031  
Non-lacq. Brass
- 033  
Vintage Brass
- 044  
Lifetime Satin Brass
- 055  
Lifetime Polished Nickel
- 056  
Lifetime Satin Nickel
- 102  
Oil R. Bronze
- 112  
Venetian Bronze
- 190  
Satin Black
- 260  
Polished Chrome

\*Some finishes not available in certain styles

**BALDWIN ESTATES PRE-CONFIGURED LEVERSETS**



Baldwin Quick Ship Passage, Privacy and Dummy sets ship from Baldwin in 2 weeks. Works with 1-3/8" and 1-3/4" thick doors. Passage and Privacy functions ship with a full lip strike and pre-bore adaptor. Quick ship is only available with 2-3/8" backset latch.



3

**5112 LEVER W/ 5075 ROSE**

	Code	Description	List
	5112.XXX.FD	Full Dummy	\$ 283
	5112.XXX.R/LDM	R/L Half Dummy	140
	5112.XXX.PASS	Passage	363
	5112.XXX.PRIV	Privacy	363

**5122 LEVER W/ 5022 ROSE**

	Code	Description	List
	5122.XXX.FD	Full Dummy	\$ 270
	5122.XXX.R/LDM	R/L Half Dummy	134
	5122.XXX.PASS	Passage	350
	5122.XXX.PRIV	Privacy	350

**5113 LEVER W/ 5078 ROSE**

	Code	Description	List
	5113.XXX.FD	Full Dummy	\$ 283
	5113.XXX.R/LDM	R/L Half Dummy	140
	5113.XXX.PASS	Passage	363
	5113.XXX.PRIV	Privacy	363

**5125 LEVER W/ 5048 ROSE**

	Code	Description	List
	5125.XXX.FD	Full Dummy	\$ 270
	5125.XXX.R/LDM	R/L Half Dummy	134
	5125.XXX.PASS	Passage	350
	5125.XXX.PRIV	Privacy	350

**5116 LEVER W/ 5070 ROSE**

	Code	Description	List
	5116.XXX.FD	Full Dummy	\$ 283
	5116.XXX.R/LDM	R/L Half Dummy	140
	5116.XXX.PASS	Passage	363
	5116.XXX.PRIV	Privacy	363

**5137 LEVER W/ 5046 ROSE**

	Code	Description	List
	5137.XXX.FD	Full Dummy	\$ 270
	5137.XXX.R/LDM	R/L Half Dummy	134
	5137.XXX.PASS	Passage	350
	5137.XXX.PRIV	Privacy	350

**5118 LEVER W/ 5076 ROSE**

	Code	Description	List
	5118.XXX.FD	Full Dummy	\$ 283
	5118.XXX.R/LDM	R/L Half Dummy	140
	5118.XXX.PASS	Passage	363
	5118.XXX.PRIV	Privacy	363

**5138 LEVER W/ 5047 ROSE**

	Code	Description	List
	5138.XXX.FD	Full Dummy	\$ 270
	5138.XXX.R/LDM	R/L Half Dummy	134
	5138.XXX.PASS	Passage	350
	5138.XXX.PRIV	Privacy	350

**5121 LEVER W/ R012 ROSE**

	Code	Description	List
	5121.XXX.FD	Full Dummy	\$ 315
	5121.XXX.R/LDM	R/L Half Dummy	158
	5121.XXX.PASS	Passage	395
	5121.XXX.PRIV	Privacy	395

**5141 LEVER W/ R033 ROSE**

	Code	Description	List
	5141.XXX.FD	Full Dummy	\$ 283
	5141.XXX.R/LDM	R/L Half Dummy	140
	5141.XXX.PASS	Passage	363
	5141.XXX.PRIV	Privacy	363

**Available Finishes**



003  
Lifetime Polished Brass



031  
Non-lacq. Brass



033  
Vintage Brass



044  
Lifetime Satin Brass



055  
Lifetime Polished Nickel



056  
Lifetime Satin Nickel



102  
Oil R. Bronze



112  
Venetian Bronze



190  
Satin Black



260  
Polished Chrome

\*Some finishes not available in certain styles



**BALDWIN ESTATES PRE-CONFIGURED LEVERSETS**

Baldwin Quick Ship Passage, Privacy and Dummy sets ship from Baldwin in 2 weeks. Works with 1-3/8" and 1-3/4" thick doors. Passage and Privacy functions ship with a full lip strike and pre-bore adaptor. Quick ship is only available with 2-3/8" backset latch.



3

**5152 LEVER W/ 5048 ROSE**

	Code	Description	List
	5152.XXX.FD	Full Dummy	\$ 320
	5152.XXX.R/LDM	R/L Half Dummy	160
	5152.XXX.PASS	Passage	350
	5152.XXX.PRIV	Privacy	350

**5166 LEVER W/ 5046 ROSE**

	Code	Description	List
	5166.XXX.FD	Full Dummy	\$ 270
	5166.XXX.R/LDM	R/L Half Dummy	134
	5166.XXX.PASS	Passage	350
	5166.XXX.PRIV	Privacy	350

**5161 LEVER W/ 5046 ROSE**

	Code	Description	List
	5161.XXX.FD	Full Dummy	\$ 270
	5161.XXX.R/LDM	R/L Half Dummy	134
	5161.XXX.PASS	Passage	350
	5161.XXX.PRIV	Privacy	350

**5173 LEVER W/ 5046 ROSE**

	Code	Description	List
	5173.XXX.FD	Full Dummy	\$ 270
	5173.XXX.R/LDM	R/L Half Dummy	134
	5173.XXX.PASS	Passage	350
	5173.XXX.PRIV	Privacy	350

**5162 LEVER W/ R017 ROSE**

	Code	Description	List
	5162.XXX.FD	Full Dummy	\$ 279
	5162.XXX.R/LDM	R/L Half Dummy	139
	5162.XXX.PASS	Passage	329
	5162.XXX.PRIV	Privacy	329

**5190 LEVER W/ R017 ROSE**

	Code	Description	List
	5190.XXX.FD	Full Dummy	\$ 270
	5190.XXX.R/LDM	R/L Half Dummy	134
	5190.XXX.PASS	Passage	350
	5190.XXX.PRIV	Privacy	350

**5164 LEVER W/ 5046 ROSE**

	Code	Description	List
	5164.XXX.FD	Full Dummy	\$ 270
	5164.XXX.R/LDM	R/L Half Dummy	134
	5164.XXX.PASS	Passage	350
	5164.XXX.PRIV	Privacy	350

**5445V LEVER W/ 5048 ROSE**

	Code	Description	List
	5445V.XXX.FD	Full Dummy	\$ 243
	5445V.XXX.R/LDM	R/L Half Dummy	122
	5445V.XXX.PASS	Passage	295
	5445V.XXX.PRIV	Privacy	295

**5165 LEVER W/ 5046 ROSE**

	Code	Description	List
	5165.XXX.FD	Full Dummy	\$ 270
	5165.XXX.R/LDM	R/L Half Dummy	134
	5165.XXX.PASS	Passage	350
	5165.XXX.PRIV	Privacy	350

**5447V LEVER W/ R027 ROSE**

	Code	Description	List
	5440V.XXX.FD	Full Dummy	\$ 243
	5440V.XXX.R/LDM	R/L Half Dummy	122
	5440V.XXX.PASS	Passage	295
	5440V.XXX.PRIV	Privacy	295

**Available Finishes**

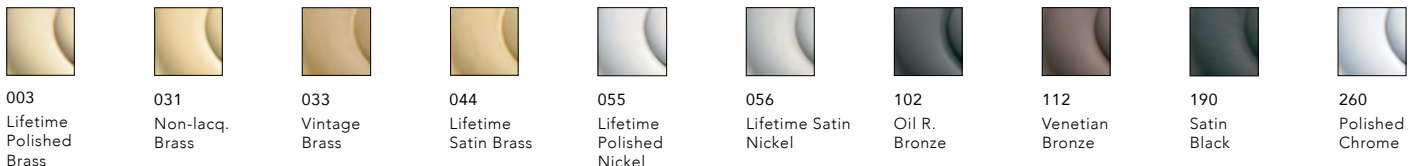

\*Some finishes not available in certain styles



**BALDWIN**

**BALDWIN ESTATES PRE-CONFIGURED LEVERSETS**

Baldwin Quick Ship Passage, Privacy and Dummy sets ship from Baldwin in 2 weeks. Works with 1-3/8" and 1-3/4" thick doors. Passage and Privacy functions ship with a full lip strike and pre-bore adaptor. Quick ship is only available with 2-3/8" backset latch.



3

**5452V LEVER W/ R030 ROSE**

	Code	Description	List
	5452V.XXX.FD	Full Dummy	\$ 243
	5452V.XXX.R/LDM	R/L Half Dummy	122
	5452V.XXX.PASS	Passage	295
	5452V.XXX.PRIV	Privacy	295

**5455V LEVER W/ 5048 ROSE**

	Code	Description	List
	5455V.XXX.FD	Full Dummy	\$ 243
	5455V.XXX.R/LDM	R/L Half Dummy	122
	5455V.XXX.PASS	Passage	295
	5455V.XXX.PRIV	Privacy	295

**5485V LEVER W/ R026 ROSE**

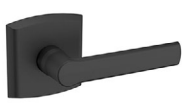
	Code	Description	List
	5485V.XXX.FD	Full Dummy	\$ 243
	5485V.XXX.R/LDM	R/L Half Dummy	122
	5485V.XXX.PASS	Passage	295
	5485V.XXX.PRIV	Privacy	295

**L015 LEVER W/ R016 ROSE**

	Code	Description	List
	L015.XXX.FD	Full Dummy	\$ 270
	L015.XXX.R/LDM	R/L Half Dummy	134
	L015.XXX.PASS	Passage	350
	L015.XXX.PRIV	Privacy	350

**L021 LEVER W/ R017 ROSE**

	Code	Description	List
	L021.XXX.FD	Full Dummy	\$ 270
	L021.XXX.R/LDM	R/L Half Dummy	134
	L021.XXX.PASS	Passage	350
	L021.XXX.PRIV	Privacy	350

**L022 LEVER W/ R017 ROSE**

	Code	Description	List
	L022.XXX.FD	Full Dummy	\$ 270
	L022.XXX.R/LDM	R/L Half Dummy	134
	L022.XXX.PASS	Passage	350
	L022.XXX.PRIV	Privacy	350

**L023 LEVER W/ R017 ROSE**

	Code	Description	List
	L023.XXX.FD	Full Dummy	\$ 283
	L023.XXX.R/LDM	R/L Half Dummy	140
	L023.XXX.PASS	Passage	363
	L023.XXX.PRIV	Privacy	363

**L024 LEVER W/ R046 ROSE**

	Code	Description	List
	L024.XXX.FD	Full Dummy	\$ 320
	L024.XXX.R/LDM	R/L Half Dummy	160
	L024.XXX.PASS	Passage	400
	L024.XXX.PRIV	Privacy	400

**L029 LEVER W/ R017 ROSE**

	Code	Description	List
	L029.XXX.FD	Full Dummy	\$ 320
	L029.XXX.R/LDM	R/L Half Dummy	160
	L029.XXX.PASS	Passage	400
	L029.XXX.PRIV	Privacy	400

**Available Finishes**



003  
Lifetime Polished Brass



031  
Non-lacq. Brass



033  
Vintage Brass



044  
Lifetime Satin Brass



055  
Lifetime Polished Nickel



056  
Lifetime Satin Nickel



102  
Oil R. Bronze



112  
Venetian Bronze



190  
Satin Black



260  
Polished Chrome

\*Some finishes not available in certain styles



**BALDWIN**

**BALDWIN ESTATES PRE-CONFIGURED KEYED ENTRY SETS**

Baldwin Pre-configured Tubular Keyed Entry Knob & Lever Sets accommodate 1-3/8" and 1-3/4" door thickness. Showing Emergency Exit functions (interior knob or lever will retract the bolt while the exterior remains locked) - other functions available special order. Some finishes available for Quick Ship.



3



**5205 CLASSIC KNOB  
W/ CLASSIC ROSE\***

Code List  
5205.XXX.ENTR\* \$ 323



**5210 COLONIAL KNOB  
W/ CLASSIC ROSE\***

Code List  
5210.XXX.ENTR\* \$ 323



**5215 CONTEMPORARY KNOB  
W/ CONTEMPORARY ROSE\***

Code List  
5215.XXX.ENTR\* \$ 323



**5225 EGG KNOB  
W/ CLASSIC ROSE\***

Code List  
5225.XXX.ENTR\* \$ 323



**5237 BETHPAGE KNOB  
W/ BETHPAGE ROSE**

Code List  
5237.XXX.ENTR \$ 323



**5230 CONTEMPORARY KNOB  
W/ ROUND ROSE**

Code List  
5230.XXX.ENTR \$ 323



**5250 CONTEMPORARY KNOB  
W/ SQUARE ROSE**

Code List  
5250.XXX.ENTR \$ 323



**5260 SQUARE LEVER  
W/ ROUND ROSE**

Code List  
5260.XXX.R/LENT \$ 323



**5285 SQUARE LEVER  
W/ SQUARE ROSE**

Code List  
5285.XXX.R/LENT \$ 323



**5237 BETHPAGE LEVER  
W/ BETHPAGE ROSE**

Code List  
5237.XXX.R/LENT \$ 323



**5245 CLASSIC LEVER  
W/ CLASSIC ROSE**

Code List  
5245.XXX.R/LENT \$ 323



**5255 WAVE LEVER  
W/ CLASSIC ROSE**

Code List  
5255.XXX.R/LENT \$ 323

## INTERIOR LEVERS

### ORDERING KNOBS/LEVER SETS A LA CARTE

- 1) Select Knob/Lever
- 2) Select Rose (or Escutcheon)
- 3) Select Latch

Additional hardware may be needed - contact MacMurray Pacific or your Sales Rep for guidance.

### BALDWIN ESTATES LEVERS

Fine Detail, Hand Polished. Order Latches and Roses Separately. See Finish Codes page 306.

3

#### 5101 LEVER

Shown with 5002 Rose

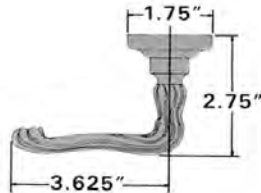

5101.XXX.MR

List  
 \$ 246

#### 5106 LEVER

Shown with 5002 Rose

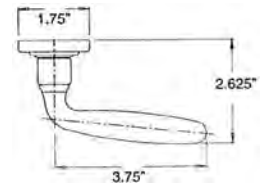

5106.XXX.MR

List  
 \$ 246

#### 5103 LEVER

Shown with 5002 Rose

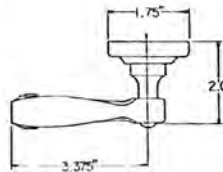

5103.XXX.MR

List  
 \$ 246

#### 5108 LEVER

Shown with 5002 Rose

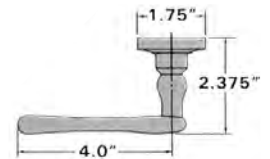

5108.XXX.MR

List  
 \$ 246

#### 5104 LEVER

Shown with 5004 Rose

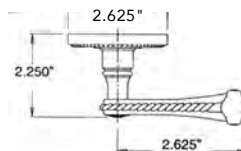

5104.XXX.MR

List  
 \$ 246

#### 5112 LEVER

Shown with 5028 Rose



5112.XXX.MR

List  
 \$ 262

#### 5105 LEVER

Shown with 5006 Rose

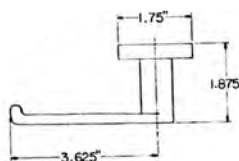

5105.XXX.MR

List  
 \$ 246

#### 5113 LEVER

Shown with 5038 Rose

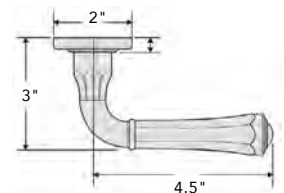

5113.XXX.MR

List  
 \$ 262

## INTERIOR LEVERS

### BALDWIN ESTATES LEVERS

Fine Detail, Hand Polished. Order Latches and Roses Separately. See Finish Codes page 306.

### ORDERING KNOBS/LEVER SETS A LA CARTE

- 1) Select Knob/Lever
- 2) Select Rose (or Escutcheon)
- 3) Select Latch

Additional hardware may be needed - contact MacMurray Pacific or your Sales Rep for guidance.

3

#### 5116 LEVER

Shown with 5010 Rose

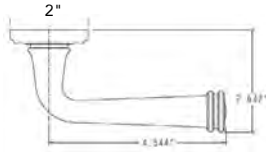

5116.XXX.MR

List  
 \$ 262

#### 5125 LEVER

Shown with 5048 Rose

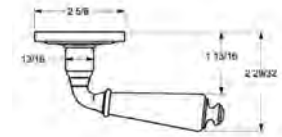

5125.XXX.MR

List  
 \$ 246

#### 5118 LEVER

Shown with 5035 Rose

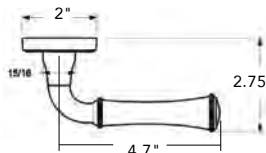

5118.XXX.MR

List  
 \$ 262

#### 5137 LEVER

Shown with 5006 Rose

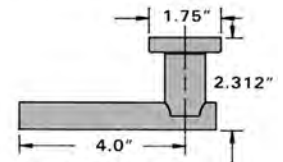

5137.XXX.MR

List  
 \$ 246

#### 5121 LEVER

Shown with R012 Rose

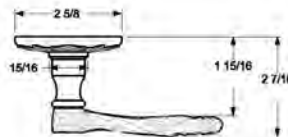

5121.XXX.MR

List  
 \$ 246

#### 5138 LEVER

Shown with 5047 Rose

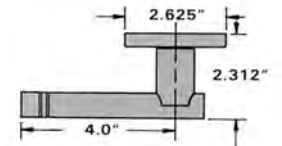

5138.XXX.MR

List  
 \$ 246

#### 5122 LEVER

Shown with 5016 Rose

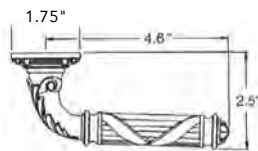

5122.XXX.MR

List  
 \$ 246

#### 5141 LEVER

Shown with R033 Rose

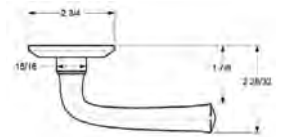

5141.XXX.MR

List  
 \$ 262





## INTERIOR LEVERS

### ORDERING KNOBS/LEVER SETS A LA CARTE

- 1) Select Knob/Lever
- 2) Select Rose (or Escutcheon)
- 3) Select Latch

Additional hardware may be needed - contact MacMurray Pacific or your Sales Rep for guidance.

### BALDWIN ESTATES LEVERS

Fine Detail, Hand Polished. Order Latches and Roses Separately. See Finish Codes page 306.

3

#### 5152 LEVER

Shown with 5017 Rose

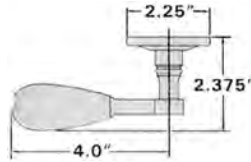

5152.XXX.MR

List  
\$ 246

#### 5165 LEVER

Shown with 5032 Rose

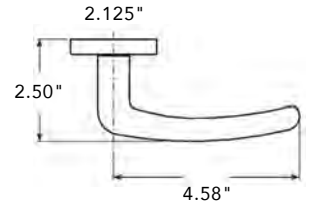

5165.XXX.MR

List  
\$ 246

#### 5161 LEVER

Shown with 5046 Rose

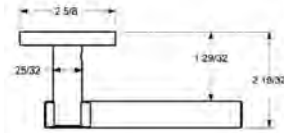

5161.XXX.MR

List  
\$ 246

#### 5166 LEVER

Shown with 5046 Rose

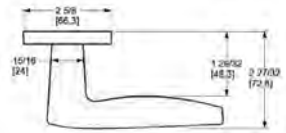

5166.XXX.MR

List  
\$ 246

#### 5162 LEVER

Shown with 5032 Rose

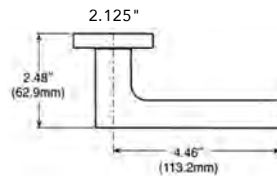

5162.XXX.MR

List  
\$ 246

#### 5167 LEVER

Shown with R052 Rose

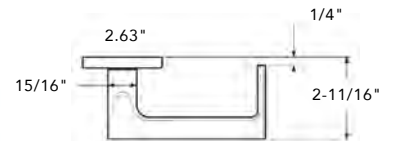

5167.XXX.MR

List  
\$ 270

#### 5164 LEVER

Shown with 5006 Rose

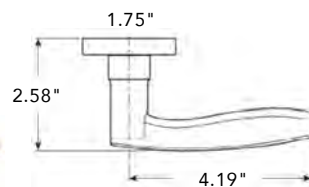

5164.XXX.MR

List  
\$ 246

#### 5173 LEVER

Shown with 5006 Rose

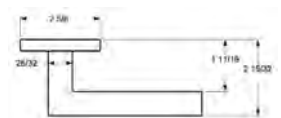

5173.XXX.MR

List  
\$ 246

## INTERIOR LEVERS

### BALDWIN ESTATES LEVERS

Fine Detail, Hand Polished. Order Latches and Roses Separately. See Finish Codes page 306.

### ORDERING KNOBS/LEVER SETS A LA CARTE

- 1) Select Knob/Lever
- 2) Select Rose (or Escutcheon)
- 3) Select Latch

Additional hardware may be needed - contact MacMurray Pacific or your Sales Rep for guidance.

3

#### 5190 LEVER

Shown with R017 Rose

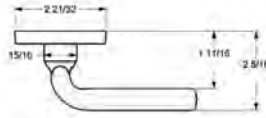
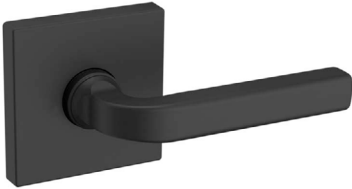

5190.XXX.MR List  
\$ 246

#### 5455V WAVE LEVER

Shown with 5048 Rose

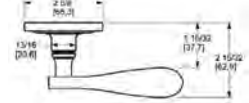

5455V.XXX.MR List  
\$ 201

#### 5445V CLASSIC LEVER

Shown with 5048 Rose

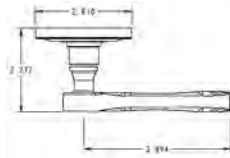

5445V.XXX.MR List  
\$ 201

#### 5485V SOHO LEVER

Shown with R026 Rose

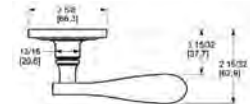
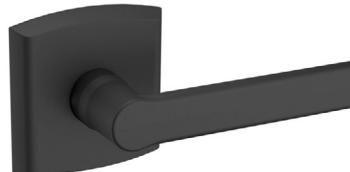

5485V.XXX.MR List  
\$ 201

#### 5447V BETHPAGE LEVER

Shown with R027 Rose

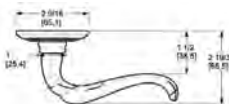

5447V.XXX.MR List  
\$ 201

#### L015 LEVER

Shown with R016 Rose

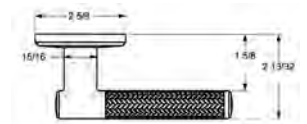

L015.XXX.MR List  
\$ 246

#### 5452V BEAVERTAIL LEVER

Shown with R030 Rose

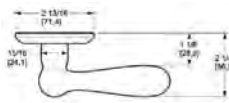

5452V.XXX.MR List  
\$ 201

#### L021 LEVER

Shown with R017 Rose

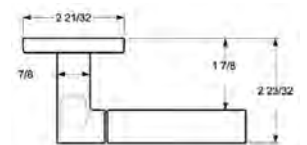

L021.XXX.MR List  
\$ 246

## INTERIOR LEVERS

### ORDERING KNOBS/LEVER SETS A LA CARTE

- 1) Select Knob/Lever
- 2) Select Rose (or Escutcheon)
- 3) Select Latch

Additional hardware may be needed - contact MacMurray Pacific or your Sales Rep for guidance.

### BALDWIN ESTATES LEVERS

Fine Detail, Hand Polished. Order Latches and Roses Separately. See Finish Codes page 306.

3

#### L022 LEVER

Shown with 5056 Rose

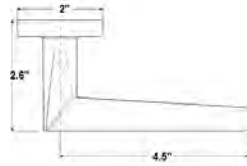

L022.XXX.MR

List  
 \$ 246

#### L030 KNURLED LEVER

Shown with R017 Rose

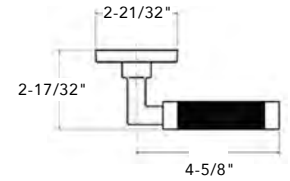

L030.XXX.MR

List  
 \$ 284

#### L023 LEVER

Shown with R017 Rose

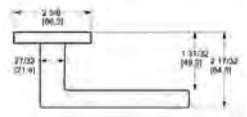

L023.XXX.MR

List  
 \$ 262

#### L029 MIXED METAL LEVER

Shown in M04 Finish

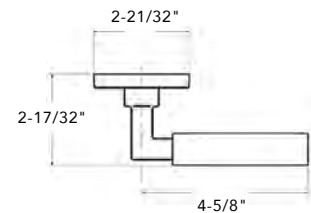

L029.XXX.MR

List  
 \$ 302

M04 is Satin Black shank and Satin Brass grip

#### L024 LEVER

Shown with R046 Rose

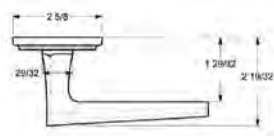

L024.XXX.MR

List  
 \$ 246

#### L030 MIXED METAL KNURLED LEVER

Shown in M01 Finish

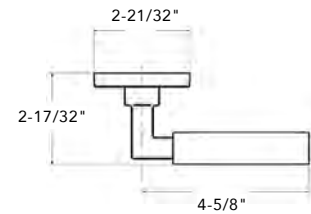

L030.XXX.MR

List  
 \$ 346

M01 is Polished Nickel shank and Satin Black grip

#### L029 LEVER

Shown with R017 Rose

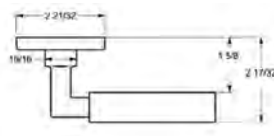

L029.XXX.MR

List  
 \$ 246

## INTERIOR KNOBS

### BALDWIN ESTATES KNOBS

Fine Detail, Hand Polished. Order Latches and Roses Separately. See Finish Codes page 306.

### ORDERING KNOBS/LEVER SETS A LA CARTE

- 1) Select Knob/Lever
- 2) Select Rose (or Escutcheon)
- 3) Select Latch

Additional hardware may be needed - contact MacMurray Pacific or your Sales Rep for guidance.

3

#### 5000 KNOB

Shown with 5002 Rose

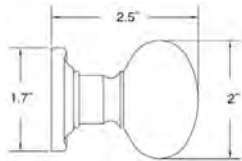

5000.XXX.MR

List  
 \$ 246

#### 5020 KNOB

Shown with 5017 Rose

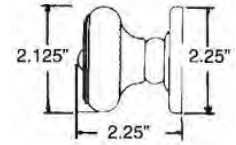

5020.XXX.MR

List  
 \$ 201

#### 5011 KNOB

Shown with 5058 Rose

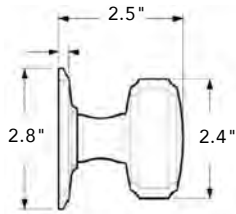

5011.XXX.MR

List  
 \$ 262

#### 5023 KNOB

Shown with R016 Rose

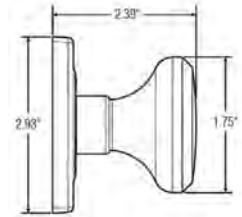

5023.XXX.MR

List  
 \$ 201

#### 5013 KNOB

Shown with 5016 Rose

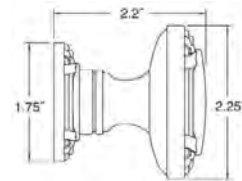

5013.XXX.MR

List  
 \$ 246

#### 5024 KNOB

Shown with R030 Rose

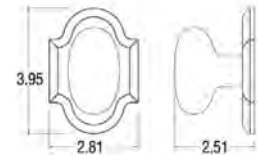

5024.XXX.MR

List  
 \$ 201

#### 5015 KNOB

Shown with 5017 Rose

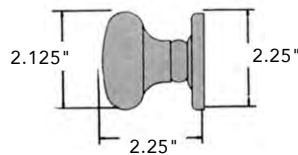

5015.XXX.MR

List  
 \$ 201

#### 5025 KNOB

Shown with 5002 Rose

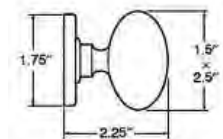

5025.XXX.MR

List  
 \$ 201

## INTERIOR KNOBS

### ORDERING KNOBS/LEVER SETS A LA CARTE

- 1) Select Knob/Lever
- 2) Select Rose (or Escutcheon)
- 3) Select Latch

Additional hardware may be needed - contact MacMurray Pacific or your Sales Rep for guidance.

### BALDWIN ESTATES KNOBS

Fine Detail, Hand Polished. Order Latches and Roses Separately. See Finish Codes page 306.

3

#### 5030 KNOB

Shown with 5002 Rose

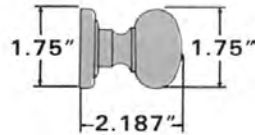

5030.XXX.MR

List  
 \$ 246

#### 5057 KNOB

Shown with 5002 Rose

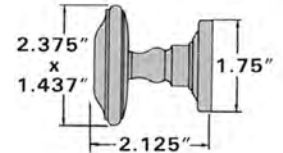

5057.XXX.MR

List  
 \$ 246

#### 5041 KNOB

Shown with 5046 Rose

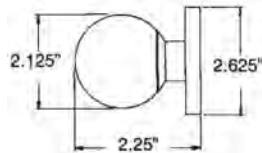

5041.XXX.MR

List  
 \$ 201

#### 5064 KNOB

Shown with 5004 Rose

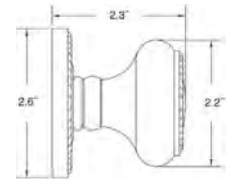

5064.XXX.MR

List  
 \$ 246

#### 5054 KNURLED KNOB

Shown with 5046 Rose

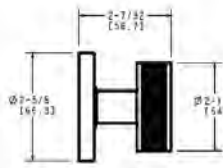

5054.XXX.MR

List  
 \$ 284

#### 5066 KNOB

Shown with 5078 Rose

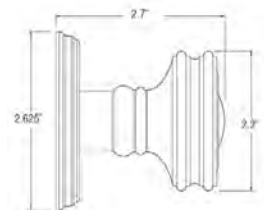

5066.XXX.MR

List  
 \$ 262

#### 5055 KNOB

Shown with 5032 Rose

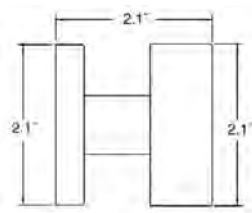

5055.XXX.MR

List  
 \$ 246

#### 5068 KNOB

Shown with 5070 Rose

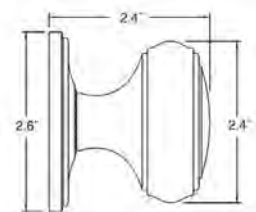

5068.XXX.MR

List  
 \$ 262



## INTERIOR KNOBS

### BALDWIN ESTATES KNOBS

Fine Detail, Hand Polished. Order Latches and Roses Separately. See Finish Codes page 306.

3

#### 5069 KNOB

Shown with 5076 Rose

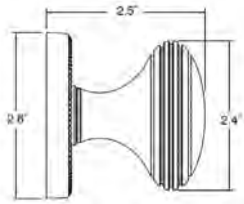

5069.XXX.MR

List  
\$ 262

#### 5073 KNOB

Shown with 5006 Rose

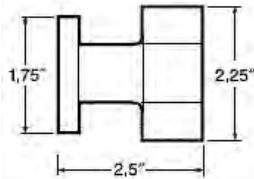

5073.XXX.MR

List  
\$ 246

#### 5077 KNOB

Shown with R027 Rose

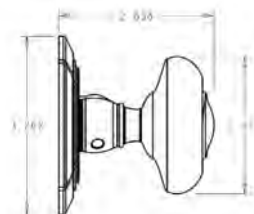

5077.XXX.MR

List  
\$ 201

#### 5080 KNOB

Shown with 5048 Rose

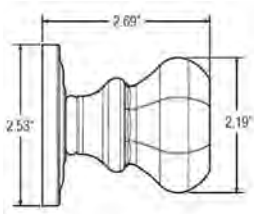

5080.XXX.MR

List  
\$ 208

### ORDERING KNOBS/LEVER SETS A LA CARTE

- 1) Select Knob/Lever
- 2) Select Rose (or Escutcheon)
- 3) Select Latch

Additional hardware may be needed - contact MacMurray Pacific or your Sales Rep for guidance.

### K007, K008, K009 HOLLYWOOD HILLS KNOBS

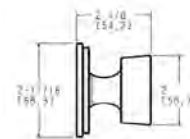

K007  
2" Dia

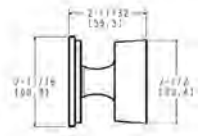

K009  
2.5" Dia

#### K008 KNOB

Shown with R050 Rose

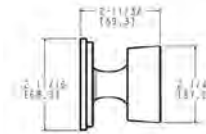

K008  
2.25" Dia

	List
K007.XXX.MR	\$ 262
K008.XXX.MR	278
K009.XXX.MR	293

### K012 TULIP KNOB

Shown with 5078 Rose

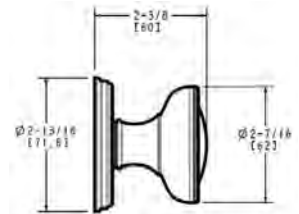

K012.XXX.MR

List  
\$ 262

### K013 COINED TULIP KNOB

Shown with 5076 Rose

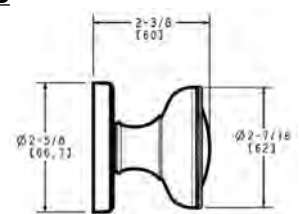

K013.XXX.MR

List  
\$ 262



# BALDWIN ROSETTES

**SOLID BRASS FORGED ROSETTES** See Finish Codes page 306.

## Traditional



5002  
1.75" Dia



5017  
2.25" Dia



5048 Pass  
5148 Priv  
2.625" Dia

Code	Description	List/pr
5002-...	Passage / Pair	\$ 77
5017-...	Passage / Pair	84
5048-...	Passage / Pair	94
5148-...	Privacy / Pair	94

## Modern



5006  
1.75" Dia



5032 Pass  
5139 Priv  
2.125" Dia



5046 Pass  
5146 Priv  
2.625" Dia

Code	Description	List/pr
5006-...	Passage / Pair	\$ 77
5032-...	Passage / Pair	84
5139-...	Privacy / Pair	84
5046-...	Passage / Pair	94
5146-...	Privacy / Pair	94

## Rope



5004 Pass  
5149 Priv  
2.625" Dia

## Ring



5047 Pass  
5147 Priv  
2.625" Dia

Code	Description	List/pr
5004-...	Passage / Pair	\$ 94
5149-...	Privacy / Pair	94
5047-...	Passage / Pair	94
5147-...	Privacy / Pair	94

## Ring



5010 Pass  
5151 Priv  
2" Dia



5070 Pass  
5123 Priv  
2.625" Dia

Code	Description	List/pr
5010-...	Passage / Pair	\$ 94
5151-...	Privacy / Pair	94
5070-...	Passage / Pair	94
5123-...	Privacy / Pair	94



5028 Pass  
5155 Priv  
2" Dia



5075 Pass  
5127 Priv  
2.625" Dia

Code	Description	List/pr
5028-...	Passage / Pair	\$ 94
5155-...	Privacy / Pair	94
5075-...	Passage / Pair	94
5127-...	Privacy / Pair	94



5035 Pass  
5156 Priv  
2" Dia



5076 Pass  
5129 Priv  
2.625" Dia



5021 Pass  
5145 Priv  
2.625" Dia

Code	Description	List/pr
5035-...	Passage / Pair	\$ 94
5156-...	Privacy / Pair	94
5076-...	Passage / Pair	94
5129-...	Privacy / Pair	94
5021-...	Passage / Pair	94
5145-...	Privacy / Pair	94



# BALDWIN ROSETTES

**SOLID BRASS FORGED ROSETTES CONT.** See Finish Codes page 306.

3



5038 Pass  
5157 Priv  
2" Dia



5078 Pass  
5134 Priv  
2.625" Dia

Code	Description	List/pr
5038-...	Passage / Pair	\$ 94
5157-...	Privacy / Pair	94
5078-...	Passage / Pair	94
5134-...	Privacy / Pair	94



R007 Pass/Priv  
2" Dia



R008 Pass/Priv  
2-5/8" Dia

Code	Description	List/pr
R007-... PS/PV	Pass or Priv / Pair	\$ 139
R008-... PS/PV	Pass or Priv / Pair	150



5042 Pass  
5142 Priv  
2.63" W x 4.125" H

Code	Description	List/pr
5042-...	Passage / Pair	\$ 94
5142-...	Privacy / Pair	94



R011 Pass/Priv  
2" Dia



R012 Pass/Priv  
2-5/8" Dia

Code	Description	List/pr
R011-... PS/PV	Pass or Priv / Pair	\$ 139
R012-... PS/PV	Pass or Priv / Pair	150



5058 Pass  
5158 Priv  
2.625" Dia



5056 Pass  
5160 Priv  
2" Sq

Code	Description	List/pr
5058-...	Passage / Pair	\$ 94
5158-...	Privacy / Pair	94
5056-...	Passage / Pair	84
5160-...	Privacy / Pair	84

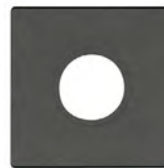

R017 Pass/Priv  
2.625" Sq



R026 Pass/Priv  
3" Sq

Code	Description	List/pr
R017-... PS/PV	Pass or Priv / Pair	\$ 94
R026-... PS/PV	Pass or Priv / Pair	94



R016 Pass/Priv  
2.625" Dia

Code	Description	List/pr
R016-... PS/PV	Pass or Priv / Pair	\$ 94



## BALDWIN ROSETTES

**SOLID BRASS FORGED ROSETTES CONT.** See Finish Codes page 306.

### Bethpage Rosettes



R027 Pass/Priv  
 2.81" W x  
 3.25" H



R054 Pass/Priv  
 2.81" W x  
 5.65" H



R029  
 Pass/Priv/Entr  
 2.81" W x  
 10.14" H  
 5.5" C/C

Code	Description	List/pr
R027-... PS/PV	Pass or Priv / Pair	\$ 94
R054-... PS/PV	Pass or Priv / Pair	158
R029-... PS/PV	Pass or Priv / Pair	302
R029-... ENTR	Entry / Pair	523

### Beveled Rectangle Rosettes



R033 Pass/Priv  
 2.75" W x  
 3.225" H



R056 Pass/Priv  
 2.75" W x  
 5.25" H



R035  
 Pass/Priv/Entr  
 2.75" W x  
 9.4" H  
 5.5" C/C

Code	Description	List/pr
R033-... PS/PV	Pass or Priv / Pair	\$ 94
R056-... PS/PV	Pass or Priv / Pair	158
R035-... PS/PV	Pass or Priv / Pair	302
R035-... ENTR	Entry / Pair	523

### Arch Rosettes



R030 Pass/Priv  
 2.81" W x  
 3.95" H



R055 Pass/Priv  
 2.81" W x  
 5.9" H



R032  
 Pass/Priv/Entr  
 2.81" W x  
 10.53" H  
 5.5" C/C

Code	Description	List/pr
R030-... PS/PV	Pass or Priv / Pair	\$ 94
R055-... PS/PV	Pass or Priv / Pair	158
R032-... PS/PV	Pass or Priv / Pair	302
R032-... ENTR	Entry / Pair	523

### Contemporary Rosettes



R052 Pass/Priv  
 2.63" W x  
 5.25" H



R048  
 Pass/Priv/Entr  
 2.63" W x  
 9.8" H  
 5.5" C/C

Code	Description	List/pr
R052-... PS/PV	Pass or Priv / Pair	\$ 162
R048-... PS/PV	Pass or Priv / Pair	302
R048-... ENTR	Entry / Pair	523

## BALDWIN ROSETTES

## LATCH SETS

### SOLID BRASS FORGED ROSETTES CONT.

See finish codes page 306

3

#### Square Rosettes



R049 Pass/Priv  
 2.25" Sq



R050 Pass/Priv  
 2.6875" Sq



R051  
 Pass/Priv/Entr  
 2.9375" W x  
 9.78125" H  
 5.5" C/C



R053 Pass/Priv  
 2.69" W x  
 5.25" H

Code	Description	List/pr
R049-... PS/PV	Pass or Priv / Pair	\$ 100
R050-... PS/PV	Pass or Priv / Pair	110
R053-... PS/PV	Pass or Priv / Pair	162
R051-... PS/PV	Pass or Priv / Pair	328
R051-... ENTR	Entry / Pair	554

#### Mid-Century Rosettes



R046 Pass/Priv  
 2.65" W x  
 4.02" H

Code	Description	List/pr
R046-... PS/PV	Pass or Priv / Pair	\$ 158

### INTERIOR TUBULAR LATCH SETS

See finish codes page 306

2-3/8" Backset

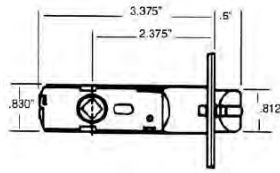

2-3/4" Backset

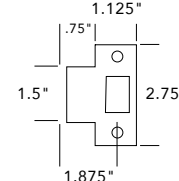
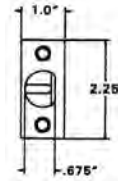
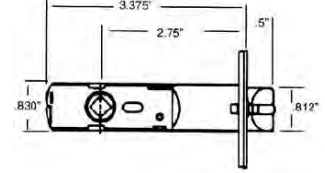

Standard Box  
 T-Strike

### PASSAGE LATCHES

5510, 5513 = 2-3/8" Backset  
 5520, 5523 = 2-3/4" Backset



Includes: Standard Box T-Strike, fasteners, dust box and spindle.

#### For Interior Passage Knob Sets

Code	Description	List/ea
5510-...	2-3/8" BS, Knob Strength	\$ 82
5520-...	2-3/4" BS, Knob Strength	82

#### For Interior Passage Lever Sets

5513-...	2-3/8" BS, Lever Strength	\$ 82
5523-...	2-3/4" BS, Lever Strength	82

### PRIVACY LATCHES

5510 P, 5513 P = 2-3/8" Backset  
 5520 P, 5523 P = 2-3/4" Backset



Includes: Standard Box T-Strike, fasteners, dust box and spindle.

#### For Interior Privacy Knob Sets

Code	Description	List/ea
5510-... P	2-3/8" BS, Knob Strength	\$ 82
5520-... P	2-3/4" BS, Knob Strength	82

#### For Interior Privacy Lever Sets

5513-... P	2-3/8" BS, Lever Strength	\$ 82
5523-... P	2-3/4" BS, Lever Strength	82

**BALDWIN ESTATES**

**TUBULAR ENTRANCE SETS**

**BALDWIN TUBULAR HANDLESETS**

Backset Adjustable for 2-3/8" or 2-3/4". Entry Sets cover 2-1/8" door prep. Full Dummies conceal a 1-1/2" bore. 5-1/2" C/C. With T-Strike. See Finish Codes page 306. Some items available for Quick Ship.



3

**BETHPAGE (Sectional) - 85327**

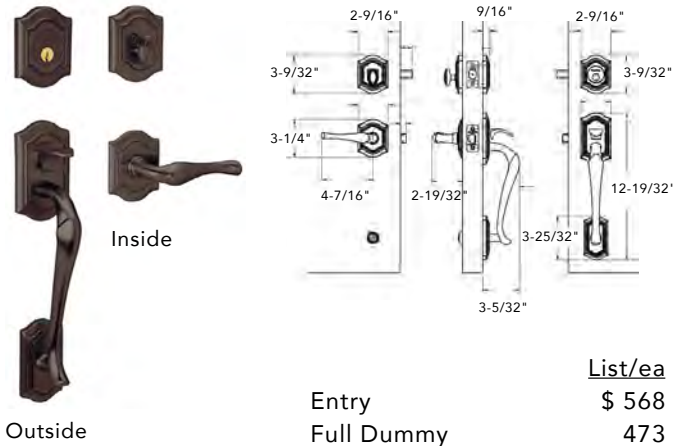

List/ea  
 \$ 568  
 473

Entry  
 Full Dummy

**BOULDER 3/4 ESCUTCHEON - 85354**

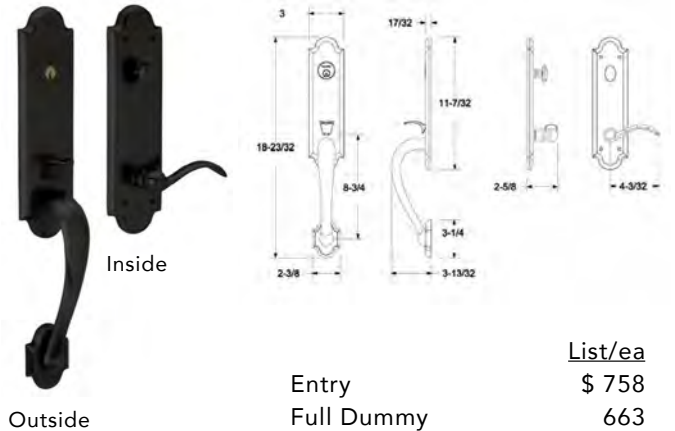

List/ea  
 \$ 758  
 663

Entry  
 Full Dummy

**BETHPAGE - 85337**

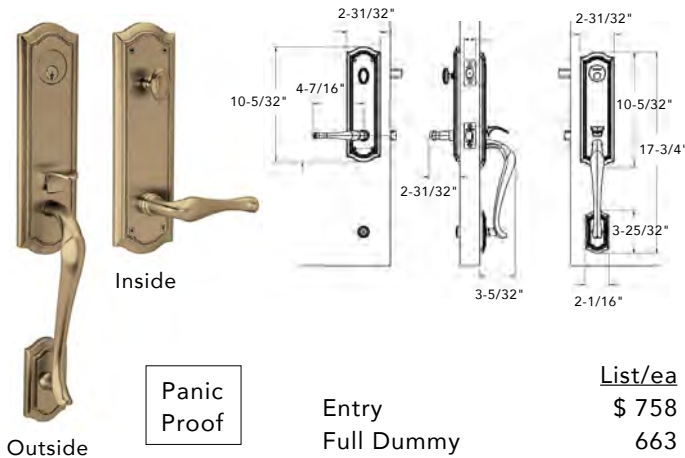

List/ea  
 \$ 758  
 663

Entry  
 Full Dummy

Panic  
 Proof

**BOULDER FULL ESCUTCHEON - 6402**

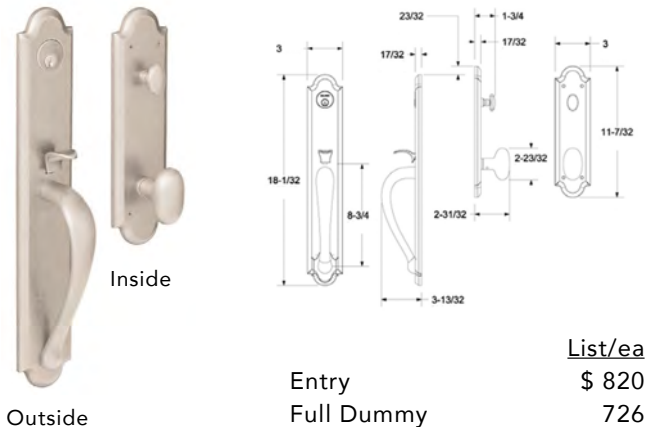

List/ea  
 \$ 820  
 726

Entry  
 Full Dummy

**BLAKELY - 85360**

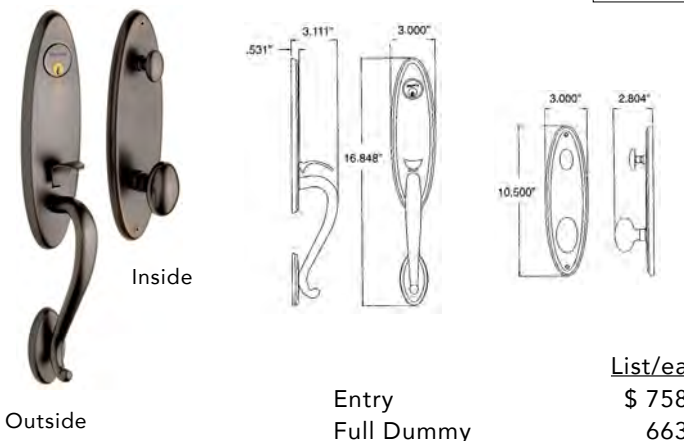

List/ea  
 \$ 758  
 663

Entry  
 Full Dummy

Panic  
 Proof

**CODY 3/4 ESCUTCHEON - 85352**

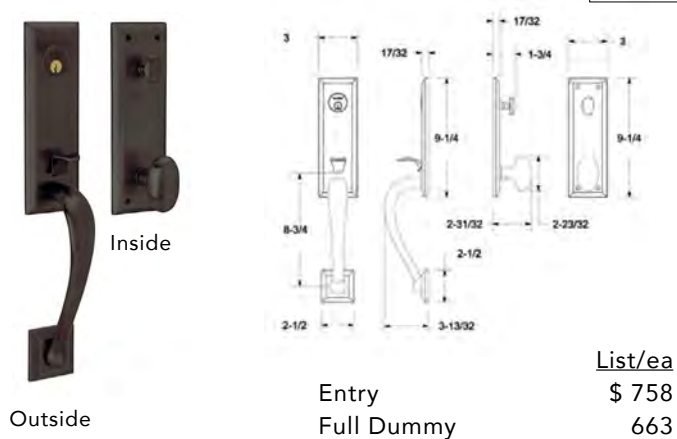

List/ea  
 \$ 758  
 663

Entry  
 Full Dummy

Panic  
 Proof

**TUBULAR ENTRANCE SETS**

**BALDWIN ESTATES**

**BALDWIN TUBULAR HANDLESETS**

Backset Adjustable for 2-3/8" or 2-3/4". Entry Sets cover 2-1/8" door prep. Full Dummies conceal a 1-1/2" bore. 5-1/2" C/C. With T-Strike. See Finish Groups page 306. Some items available for Quick Ship.



3

**CODY FULL ESCUTCHEON - 6403**

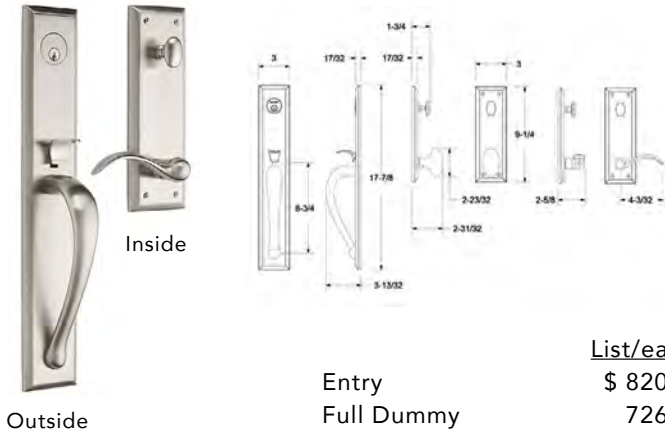

List/ea  
 \$ 820  
 726

Entry  
 Full Dummy

**LOGAN - 85315**

Interior Knob: Classic

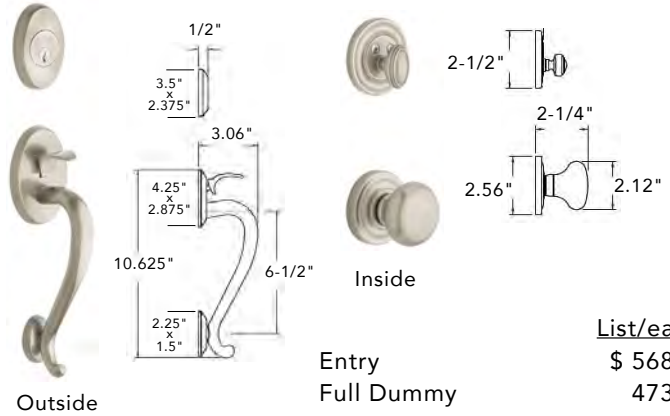

List/ea  
 \$ 568  
 473

Entry  
 Full Dummy

**HOLLYWOOD HILLS (Sectional) - 85310**

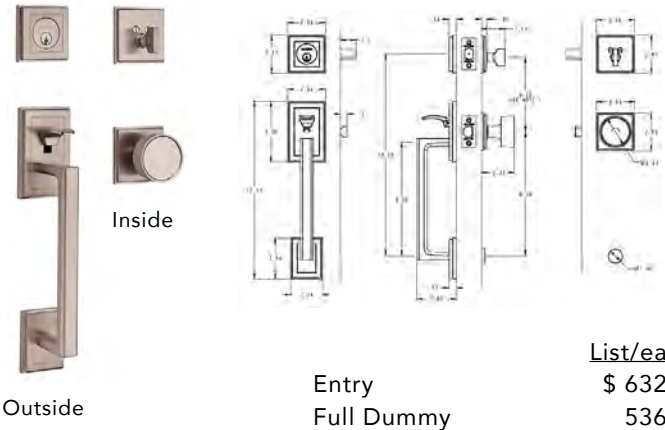

List/ea  
 \$ 632  
 536

Entry  
 Full Dummy

**MADISON - 85320**

Interior Knob: Classic

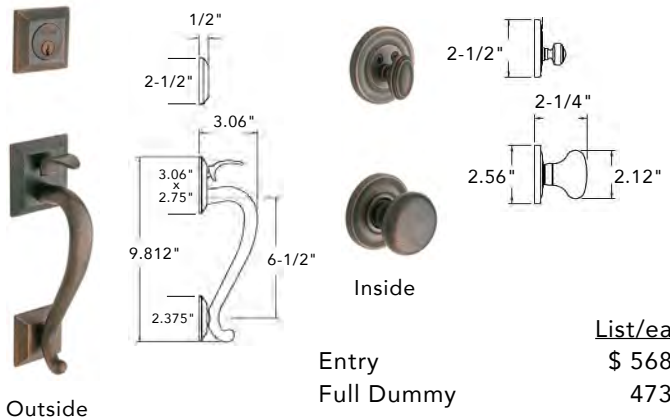

List/ea  
 \$ 568  
 473

Entry  
 Full Dummy

**HOLLYWOOD HILLS - 85311**

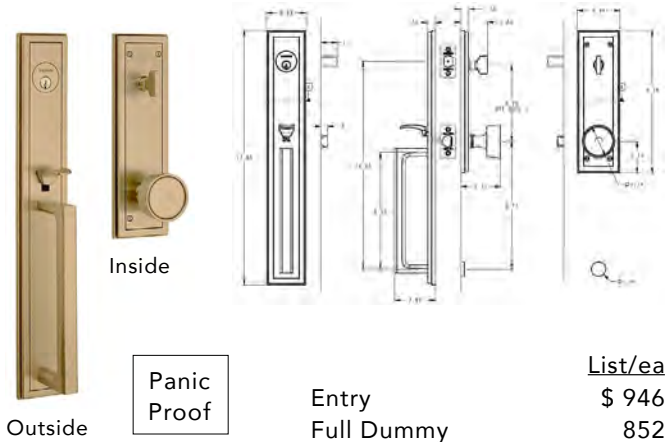

List/ea  
 \$ 946  
 852

Entry  
 Full Dummy

Panic  
 Proof

**MANCHESTER - 85350**

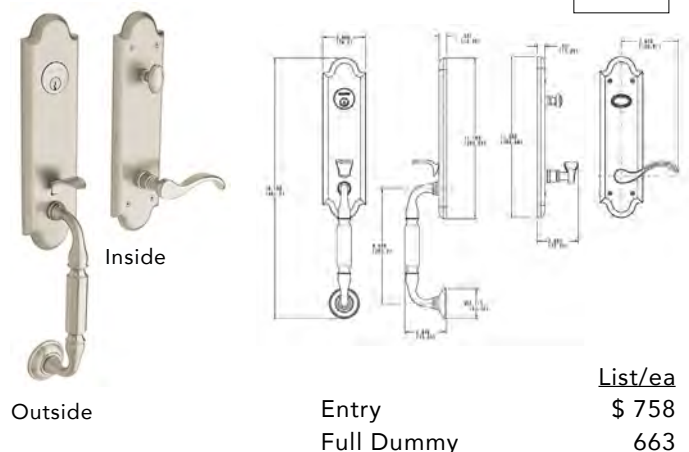

List/ea  
 \$ 758  
 663

Entry  
 Full Dummy

Panic  
 Proof

**BALDWIN ESTATES**

**TUBULAR ENTRANCE SETS**

**BALDWIN TUBULAR HANDLESETS**

Backset Adjustable for 2-3/8" or 2-3/4". Entry Sets cover 2-1/8" door prep. Full Dummies conceal a 1-1/2" bore. 5-1/2" C/C. With T-Strike. See Finish Groups page 306. Some items available for Quick Ship.



3

**MINNEAPOLIS (Sectional) - 85390**

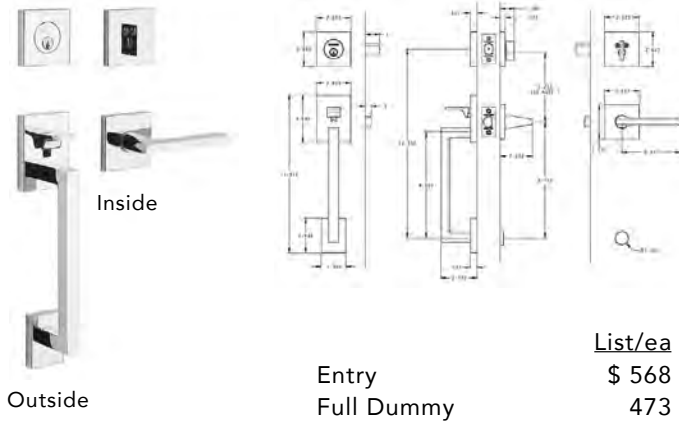

List/ea  
 \$ 568  
 473

Entry  
 Full Dummy

**PALM SPRINGS - 85397**

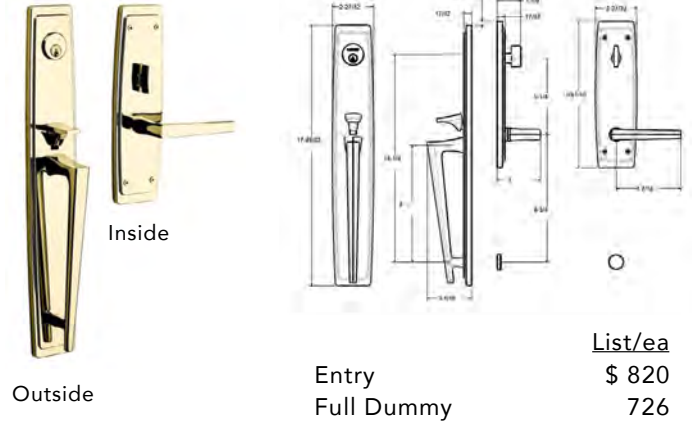

List/ea  
 \$ 820  
 726

Entry  
 Full Dummy

**MINNEAPOLIS 3/4 ESCUTCHEON - 85391**

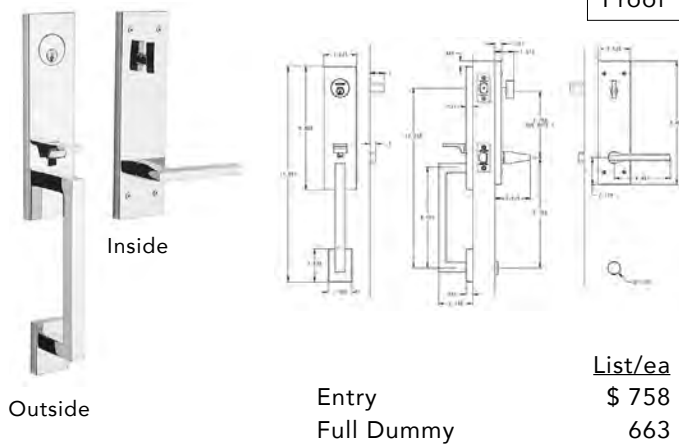

List/ea  
 \$ 758  
 663

Entry  
 Full Dummy

Panic  
 Proof

**SOHO 3/4 ESCUTCHEON - 85387**

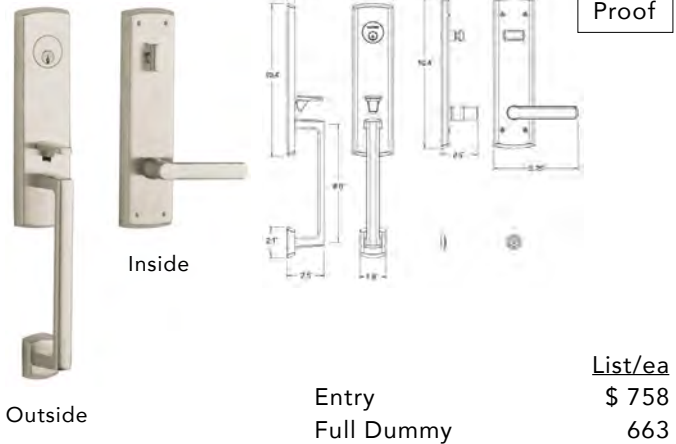

List/ea  
 \$ 758  
 663

Entry  
 Full Dummy

Panic  
 Proof

**MINNEAPOLIS FULL ESCUTCHEON - 85392**

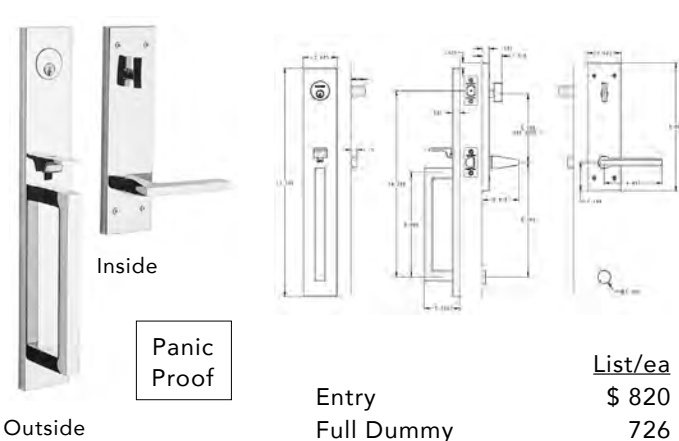

List/ea  
 \$ 820  
 726

Entry  
 Full Dummy

Panic  
 Proof

**SOHO (Sectional) - 85386**

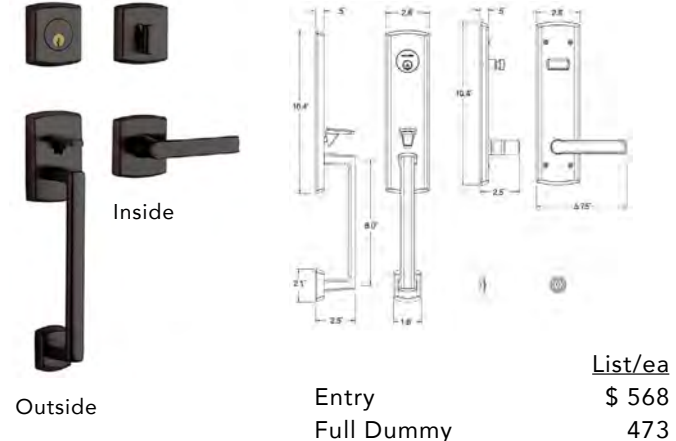

List/ea  
 \$ 568  
 473

Entry  
 Full Dummy

## TUBULAR ENTRANCE SETS

### BALDWIN TUBULAR HANDLESETS

Backset Adjustable for 2-3/8" or 2-3/4". Entry Sets cover 2-1/8" door prep. Full Dummies conceal a 1-1/2" bore. 5-1/2" C/C. With T-Strike. See Finish Groups page 306. Some items available for Quick Ship.

3



### STONEGATE - 85355



Inside

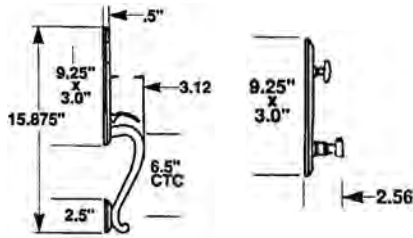

Panic Proof

List/ea  
 \$ 758  
 663

Entry  
 Full Dummy

Outside

### TREMONT - 85342

Interior Knob: 5069



Inside

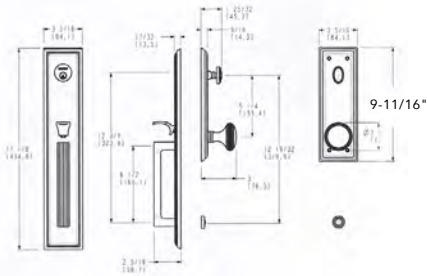

Panic Proof

List/ea  
 \$ 820  
 726

Entry  
 Full Dummy

Outside

## BALDWIN ESTATES

### Door Prep for Tubular Standard Entrance Sets

#### Single Cylinder Entrance Lockset

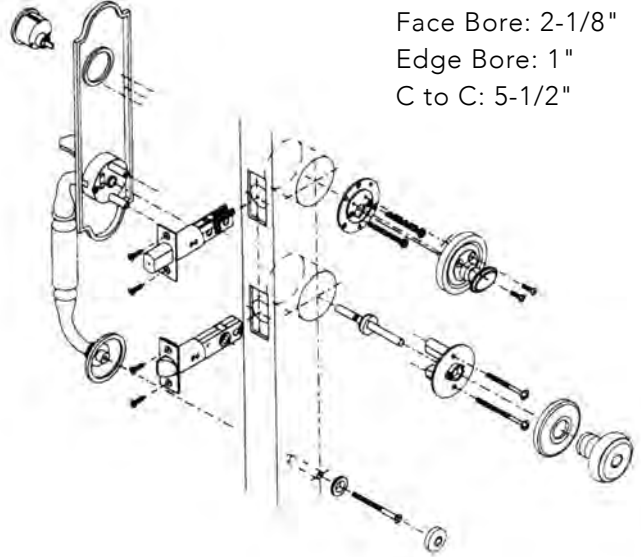

Face Bore: 2-1/8"  
 Edge Bore: 1"  
 C to C: 5-1/2"

### Door Prep for Tubular Panic Proof Entrance Sets

Lever retracts both latch and deadbolt

#### Single Cylinder Entrance Lockset

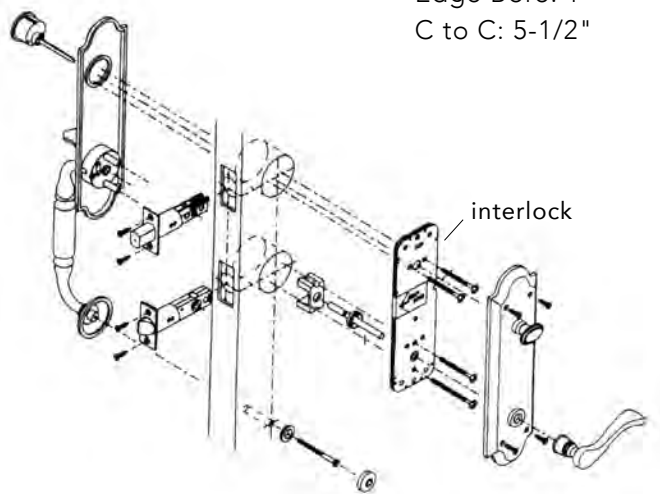

Face Bore: 2-1/8"  
 Edge Bore: 1"  
 C to C: 5-1/2"

## BALDWIN ESTATES

## TWO-POINT LOCK SETS

### **BALDWIN TUBULAR TWO-POINT LOCK SETS:** Double lock security with style

For Door Thickness: 1-3/4" to 2".

Backset: Latch and Deadbolt adjustable to 2-3/8" or 2-3/4".

\* W/ Extended Full Lip Strike.

Retrofit/Replaces Schlage E Series Locks! Installs on doors pre-bored 2-1/8" at 5-1/2" centers. Deadlock above, Deadlatch below. See Finish Groups page 306. Some items available for Quick Ship.



3

### **SOHO - Handleset x Lever # 85385**

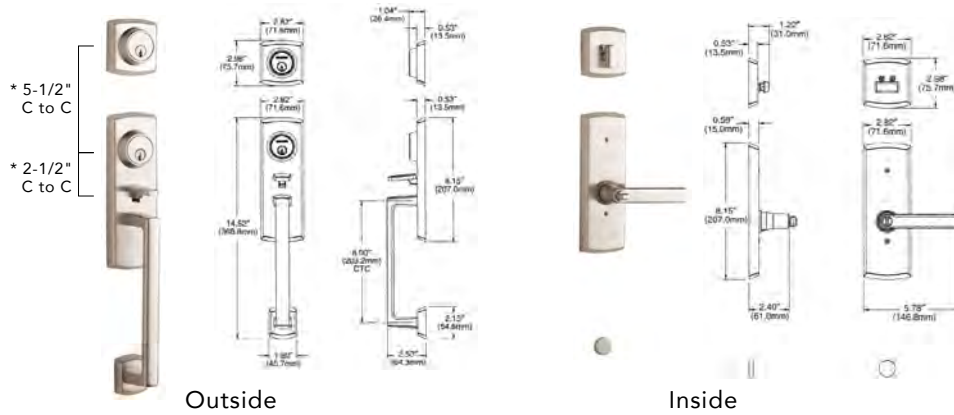

Specify LH or RH

Entry, LH/RH  
 Full Dummy

List/ea  
 \$ 758  
 663

### **LANDON - Handleset x Knob # 85345**

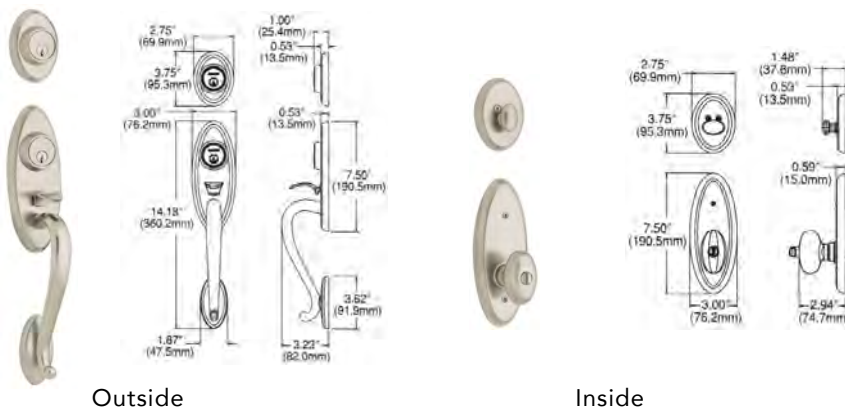

Entry  
 Full Dummy

List/ea  
 \$ 758  
 663



## DEADBOLTS

## BALDWIN ESTATES

### **BALDWIN DEADBOLTS for 1-5/8" Door Prep**

Stylish **low profile** deadbolts feature a 1" throw deadbolt that is saw-proof, a strike plate reinforcer, solid brass trim rings, and Schlage "C" keyway.

**Grade 1.** For 1-5/8" door prep. Adjustable Backset: 2-3/8" and 2-3/4". For 1-3/4" thick doors.  
Edge Bore: 1" Cross Bore: 1-5/8" Proj: 9/16"

### **TRADITIONAL DEADBOLT - Low Profile**

For 1-5/8" Door Prep



8031 - Single Cylinder  
8021 - Double Cylinder

- Low Profile
- Adjustable Backset for 2-3/8" and 2-3/4"
- Grade 1

Code	Description	List/ea
*8031.XXX	Single Cylinder	\$ 143
8021.XXX	Double Cylinder	177

See Finish Groups page 306. **\*Stocking some finishes**

### **CONTEMPORARY DEADBOLT**

For 1-5/8" Door Prep



8041 - Single Cylinder  
8011 - Double Cylinder

- Low Profile
- Adjustable Backset for 2-3/8" and 2-3/4"
- Grade 1

Code	Description	List/ea
*8041.XXX	Single Cylinder	\$ 143
8011.XXX	Double Cylinder	177

See Finish Groups page 306. **\*Stocking some finishes**

### **BALDWIN DEADBOLTS for 2-1/8" Door Prep**

These **low profile** dead bolts will cover a 2-1/8" cylindrical cutout. Other features: 1" throw is saw-proof, strike plate reinforcer, solid brass trim rings and Schlage "C" Keyway.

**Grade 1.** For 2-1/8" door prep. Adjustable Backset: 2-3/8" and 2-3/4". For 1-3/4" thick doors.  
Edge Bore: 1" Cross Bore: 2-1/8" Proj: 9/16"

### **TRADITIONAL DEADBOLT - Low Profile**

For 2-1/8" Door Prep



8231 - Single Cylinder  
8232 - Double Cylinder

- Low Profile
- Adjustable Backset for 2-3/8" and 2-3/4"
- Grade 1

Code	Description	List/ea
*8231.XXX	Single Cylinder	\$ 143
*8231.XXX.PAT	Patio	108
8232.XXX	Double Cylinder	177

See Finish Groups page 306. **\*Stocking some finishes**

### **CONTEMPORARY DEADBOLT**

For 2-1/8" Door Prep



8241 - Single Cylinder  
8242 - Double Cylinder

- Low Profile
- Adjustable Backset for 2-3/8" and 2-3/4"
- Grade 1

Code	Description	List/ea
*8241.XXX	Single Cylinder	\$ 143
*8241.XXX.PAT	Patio	108
8242.XXX	Double Cylinder	177

See Finish Groups page 306. **\*Stocking some finishes**



**BALDWIN ESTATES**

**DEADBOLTS**

3

**BALDWIN DEADBOLTS for 2-1/8" Door Prep - Continued**

These **low profile** dead bolts will cover a 2-1/8" cylindrical cutout. Other features: 1" throw is saw-proof, strike plate reinforcer, solid brass trim rings and Schlage "C" Keyway. See Finish Groups page 306. Some items available for Quick Ship.

**Grade 1.** For 2-1/8" door prep. Adjustable Backset: 2-3/8" and 2-3/4". For 1-3/4" thick doors.  
 Edge Bore: 1" Cross Bore: 2-1/8" Proj: 9/16"

**CONTEMPORARY DEADBOLT - #8220**



Single  
 Cylinder

List/ea  
 \$ 172

**BETHPAGE DEADBOLT - #8237**



Single  
 Cylinder

List/ea  
 \$ 172

**CONTEMPORARY DEADBOLT - #8244**



Single  
 Cylinder

List/ea  
 \$ 172

**SOHO DEADBOLT - #8285**



Single  
 Cylinder

List/ea  
 \$ 172

**HOLLYWOOD HILLS DEADBOLT - #8260**



Single  
 Cylinder

List/ea  
 \$ 186

**ARCHED DEADBOLT - #8252**



Single  
 Cylinder

List/ea  
 \$ 172

**SQUARED DEADBOLT - #8254**



Single  
 Cylinder

List/ea  
 \$ 172



## DEADBOLT ACCESSORIES

## BALDWIN

### DEADBOLT LATCH

8201



Furnished with a 1" throw. Contains a saw-proof hardened steel insert to prevent tampering. Fronts are adjustable for beveled door conditions. Adjustable Backset: 2-3/8" or 2-3/4". Front length: 2-1/4", Front width: 1".

Code	Description	List/ea
8201.XXX.DB	Double Cylinder/ Patio	\$ 50
8208.XXX.DB	Single Cylinder	50

### SECURITY STRIKE (Standard)

For Baldwin Deadbolts

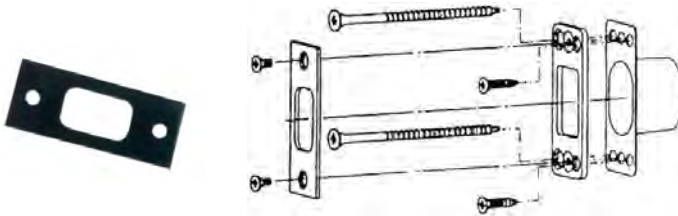

Supplied standard with all Baldwin auxiliary deadbolts. Has reinforcing plate and long screws for fastening through the jamb into a stud wall. This provides added security and tamper-resistant installation. With screws and dust box.

Strike: 1.125" x 2.75" x .064"  
Reinforcing Plate: 1.1" x 2.725" x .125"  
Dust box: 1.093" x 2.718" x .906"

Available in all standard finishes from Baldwin.

Code	Description	List/ea
8000.XXX.STR	Std security strike for deadbolts	\$ 15

### TRIM RINGS for 2-1/8" HOLE

Designed for use w/ installation of deadbolts in 2-1/8" dia. door preparation. One pair of rings is required for use in this application for either Double or Single Cylinder or Cylinder/Turnpiece functions. Dims: 2.5" dia. 2 ea./box. Stocking some finishes.



Code	Description	List/ea
8090.XXX	Trim Rings	\$ 22

### CYLINDER COLLAR SPACERS

For 1-3/8" Doors



#8097  
For 8000  
Series  
Deadbolts



#8297  
For 8200  
Series  
Deadbolts

Use when installation on a 1-3/8" door is required. Always used under cylinder collar. Two rings are required for double cylinder functions, one for single cylinder. Stocking some finishes.

Code	Description	List/ea
8097.XXX	Spacer for 8000 series DBs	\$ 22
8297.XXX	Spacer for 8200 series DBs	31

### DEADBOLT TAILPIECES



Code	Description	List/ea
8053-028-TP425	Cylinder Tailpiece for single cylinder dead- bolt, 1-3/4" doors.	\$ 4

### BALDWIN CONVERSION KITS

Includes tailpieces, thru-bolts, and hex socket wrench for modifying standard deadbolts for use on doors 2" & 2-1/4" in thickness. One set/ box.



Code	Function	List/ea
8098-000-TP03	Cylinder/Turnpiece	\$ 7
8098-000-DC03	Double Cylinder	7



## HOW TO ORDER A BALDWIN ESTATES LOCK The Most Common Residential Applications

- Full Design Flexibility
- Maximum Security
- Maximum Owner Convenience

3

### Baldwin Estates Entrance Sets (Key Locks)

**HANDLESET TRIM WITH INTERIOR KNOB**

Choose Trim

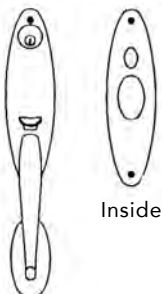

Outside Inside

Choose Cylinder



+



Choose Mortise Box

\*6321 (2-1/2" Backset)  
\*6021 (2-3/4" Backset)

= Complete Lock

**HANDLESET TRIM WITH INTERIOR LEVER**

Choose Trim

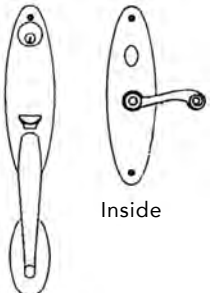

Outside Inside

Choose Cylinder



+



Choose Mortise Box

6830 (1-1/2" Backset)  
6832 (2" Backset)  
\*6321 LS (2-1/2" Backset)  
\*6021 LS (2-3/4" Backset)

= Complete Lock

**KNOB SET TRIM**

Choose Trim

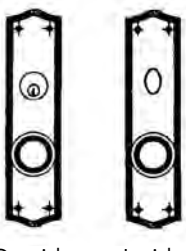

Outside Inside

Choose Cylinder



+

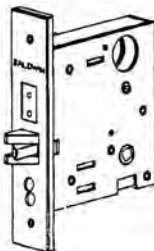

Choose Mortise Box

\*6375 (2-1/2" Backset)  
\*6075 (2-3/4" Backset)

= Complete Lock

**LEVER SET TRIM**

Choose Trim

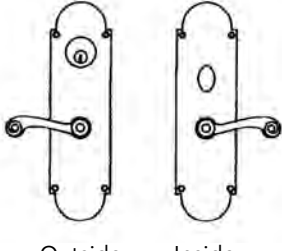

Outside Inside

Choose Cylinder



+

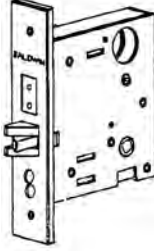

Choose Mortise Box

6800 (1-1/2" Backset)  
6802 (2" Backset)  
\*6375 LS (2-1/2" Backset)  
\*6075 LS (2-3/4" Backset)

= Complete Lock

\*Emergency Egress Locks: Inside knob or lever retracts latch and deadbolt.



## HOW TO ORDER BALDWIN ESTATES FOR 2-1/8" CROSS BORE

3

- Full Design Flexibility
- Premium Detailing
- 18° Latch Action
- Hand Polished

### 1) 2-1/8" CROSS BORE: PASSAGE SETS (INTERIOR LOCKS)

Choose 1 pair Levers or Knobs (minus rose) + Choose 1 pair 2-5/8" Roses 5048 (Traditional) or 5046 (Modern) or 5004 (Rope Design) (See Other Roses pgs 322-25) + 1 each 6503-009 (knob strength) **or** 6504-009 (lever strength) 2-1/8" Cross Bore Adapter + 1 each Tubular Latch 5513 - Lever 5510 - Knob = Complete Set

### 2) 2-1/8" CROSS BORE: PRIVACY SETS (INTERIOR LOCKS)

Choose 1 pair Levers or Knobs (minus rose) + Choose 1 pair 2-5/8" Roses 5148 (Traditional) or 5146 (Modern) or 5149 (Rope Design) (See Other Roses pgs 322-25) + 1 each 6503-009 (knob strength) **or** 6504-009 (lever strength) 2-1/8" Cross Bore Adapter + 1 each Tubular Latch 5513-P - Lever 5510-P - Knob = Complete Set

### 3) 2-1/8" CROSS BORE: FULL DUMMY SETS (INTERIOR LOCKS)

(For doors which have been pre-bored 2-1/8")







Choose 1 pair Levers or Knobs (minus rose) + Choose 1 pair 2-5/8" Roses 5048 (Traditional) or 5046 (Modern) or 5004 (Rope Design) (See Other Roses pgs 322-25) + 1 each 6503-009 (knob strength) **or** 6504-009 (lever strength) 2-1/8" Cross Bore Adapter + 1 each 5090 Dummy Insert = Complete Dummy Set

## HOW TO ORDER BALDWIN ESTATES FOR 3/4" CROSS BORE

### 1) 3/4" CROSSBORE: PASSAGE SETS (INTERIOR)

Pair of Levers and Roses		+		5513 Lever Latch 2-3/8" Backset	=	<b>Complete Set</b>
Pair of Knobs and Roses		+		5510 Knob Latch 2-3/8" Backset	=	<b>Complete Set</b>

### 2) 3/4" CROSSBORE: PRIVACY SETS (INTERIOR)

Pair of Levers		+		5513-P Lever Latch 2-3/8" Backset	+		Pair of 5139 Privacy Rose (2-1/4" dia)	=	<b>Complete Set</b>
Pair of Knobs		+		5510-P Knob Latch 2-3/8" Backset	+		Pair of 5139 Privacy Rose (2-1/4" dia)	=	<b>Complete Set</b>

**OR: Order Passage Set as shown on #1 above, and install mortise bolt above it:**

	Privacy Bolt 2-3/8" Backset 0419 (Traditional) or 0418 (Modern)	+		Emergency Release Trim (optional) 0416 (Traditional) or 0415 (Modern)	=	<b>Complete Set</b>
---	--	---	---	--	---	---------------------

If different turnpiece needed, order 0418 LT plus the turnpiece required.

### 3) 3/4" CROSSBORE: FULL DUMMY SETS (INTERIOR)

Pair of Lever or Knobs and Roses		+		Two each 5098-009 Dummy Trim Plates	+		Spindle	=	<b>Full Dummy Set</b>
----------------------------------	---	---	---	--	---	---	---------	---	-----------------------

### 4) 3/4" CROSSBORE: SINGLE DUMMY SETS (INTERIOR)

1/2 Pair of Lever or Knobs and 1/2 Pair Roses (Specify hand)		+		One each 5098-004 Dummy Trim Plate w/ Spindle	=	<b>Half Pair Dummy Set</b>
--	---	---	---	--	---	----------------------------

**ENTRANCE TRIM**

**BALDWIN ESTATES**

**BALDWIN ENTRANCE TRIM**

Prices for Trim Only. Order Mortise Box and Cylinder separately. See Finish Codes page 306.  
 Some items available for Quick Ship. Full Dummy Trim priced the same.

3

**BETHPAGE 3/4 ESCUTCHEON TRIM - M522**

Use 8325 Cylinder

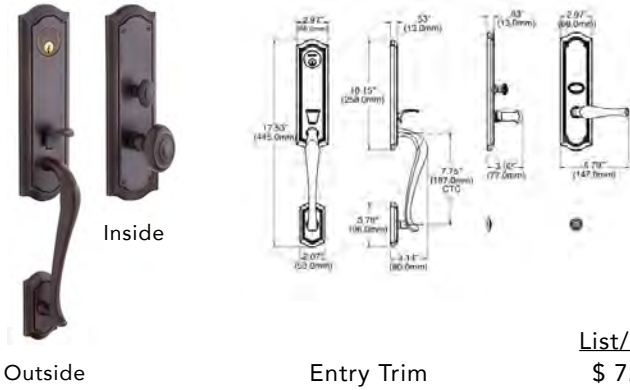

List/ea  
 \$ 723

**BRISTOL TRIM - 6963**

Use 8323 Cylinder

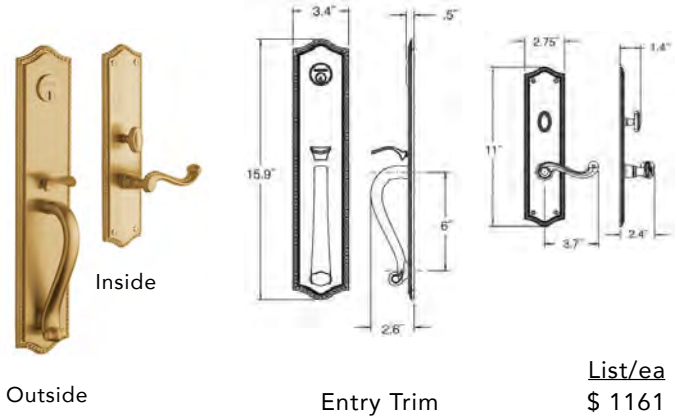

List/ea  
 \$ 1161

**BOULDER 3/4 ESCUTCHEON TRIM - M512**

Use 8325 Cylinder

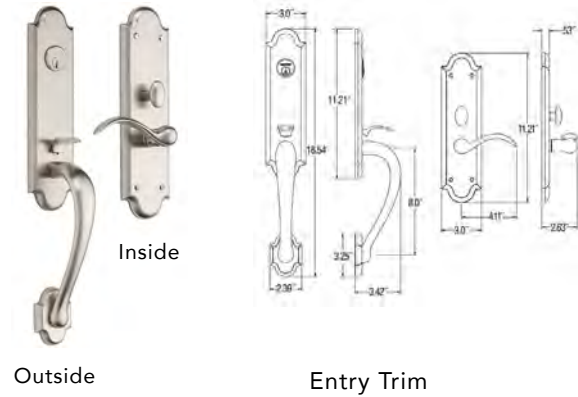

List/ea  
 \$ 723

**BOULDER FULL ESCUTCHEON TRIM - M514**

Use 8325 Cylinder

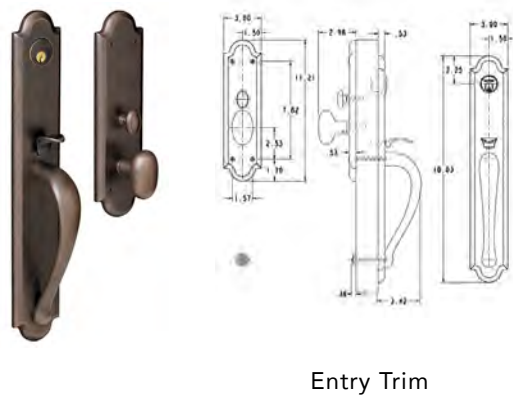

List/ea  
 \$ 939

**CODY 3/4 ESCUTCHEON TRIM - M502**

Use 8325 Cylinder

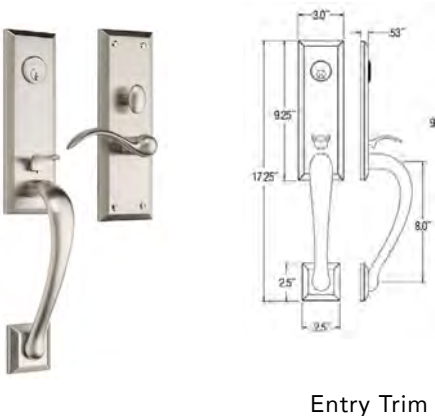

List/ea  
 \$ 723

**CODY FULL ESCUTCHEON TRIM - M504**

Use 8323 Cylinder

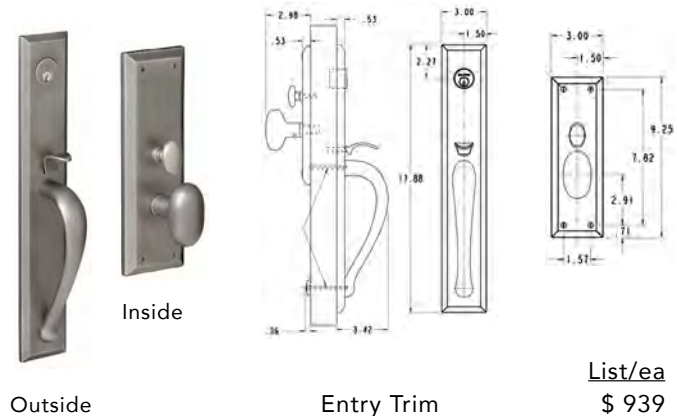

List/ea  
 \$ 939

**BALDWIN ESTATES**

**ENTRANCE TRIM**

**BALDWIN ENTRANCE TRIM**

Prices for Trim Only. Order Mortise Box and Cylinder separately. See Finish Codes page 306.  
 Some items available for Quick Ship. Full Dummy Trim priced the same.

**LAKESHORE TRIM - 6966**

Use 8323 Cylinder

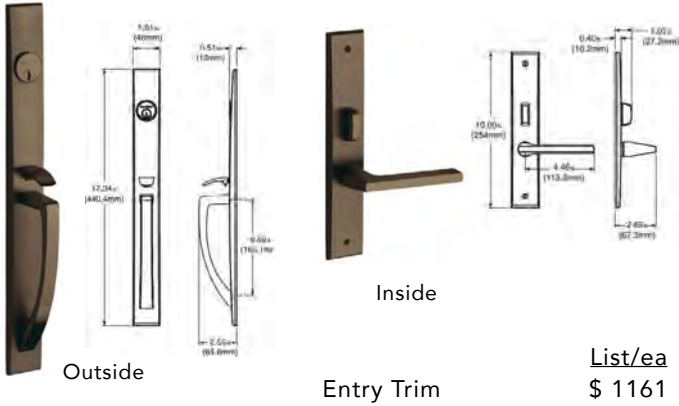

List/ea  
 \$ 1161

**HOLLYWOOD HILLS TRIM - 6946**

Use 8323 Cylinder

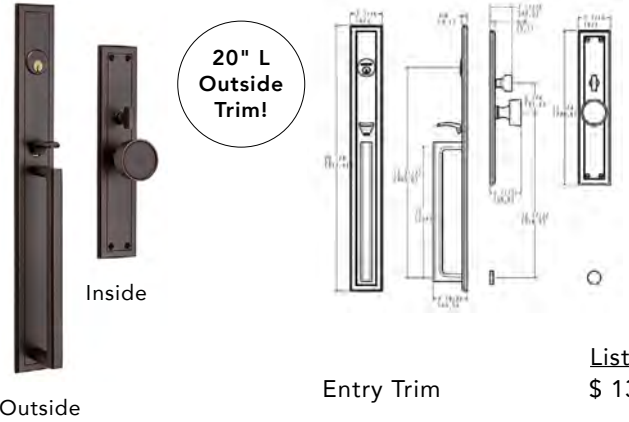

List/ea  
 \$ 1306

**MINNEAPOLIS TRIM - 6976**

Use 8323 Cylinder

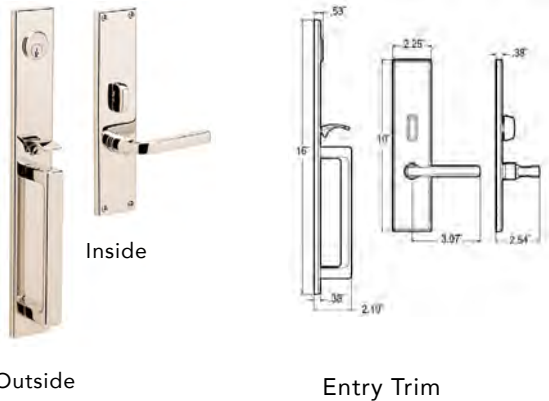

List/ea  
 \$ 939

**MINNEAPOLIS TRIM - 6977**

Use 8323 Cylinder

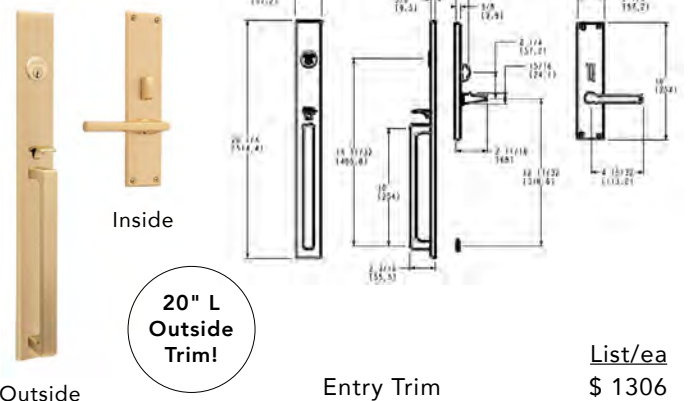

List/ea  
 \$ 1306

**EDINBURGH TRIM - 6952**

Use 8324 Cylinder

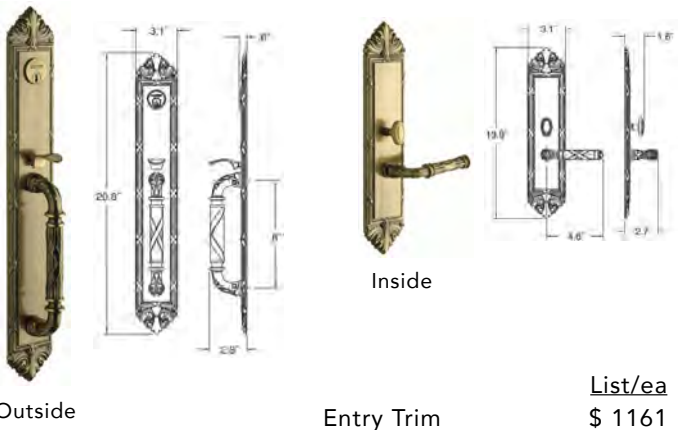

List/ea  
 \$ 1161

**HAMILTON TRIM - 6544**

Use 8326 Cylinder

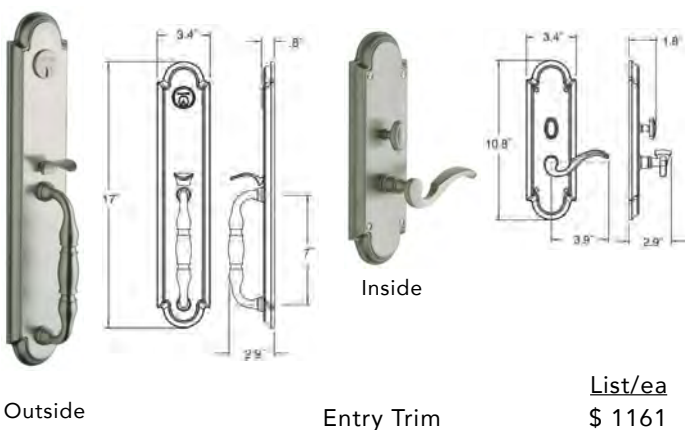

List/ea  
 \$ 1161

**ENTRANCE TRIM**

**BALDWIN ESTATES**

**BALDWIN ENTRANCE TRIM**

Prices for Trim Only. Order Mortise Box and Cylinder separately. See Finish Codes page 306.  
 Some items available for Quick Ship. Full Dummy Trim priced the same.

**3 SOHO 3/4 ESCUTCHEON TRIM - M516**

Use 8325 Cylinder

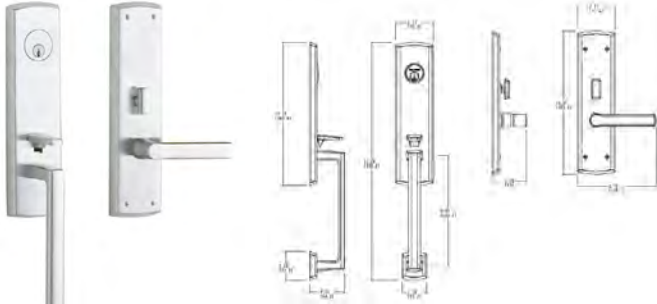

Entry Trim

List/ea  
 \$ 723

**TREMONT TRIM - 6542**

Use 8326 Cylinder

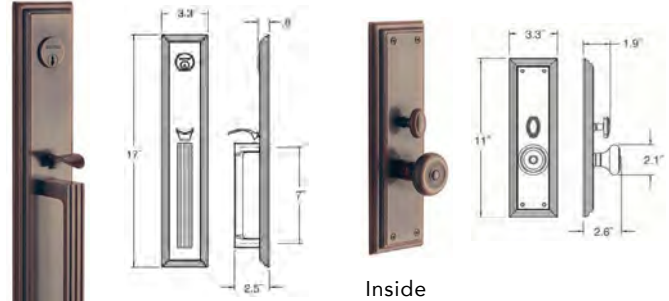

Outside

Entry Trim

List/ea  
 \$ 1161

**LEXINGTON TRIM - 6560**

Use 8323 Cylinder

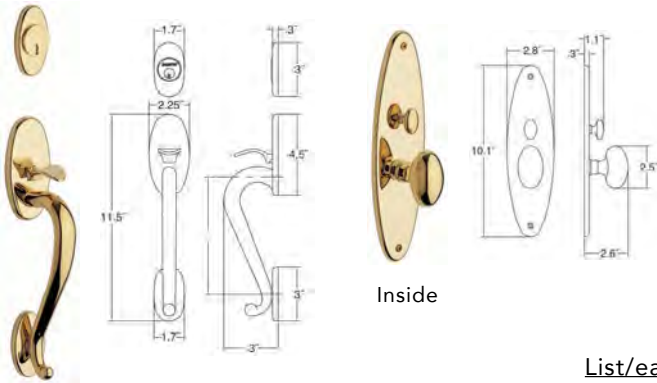

Outside

Entry Trim

List/ea  
 \$ 723

**SPRINGFIELD TRIM - 6573**

Use 8323 Cylinder. Covers 2-1/2" bore.

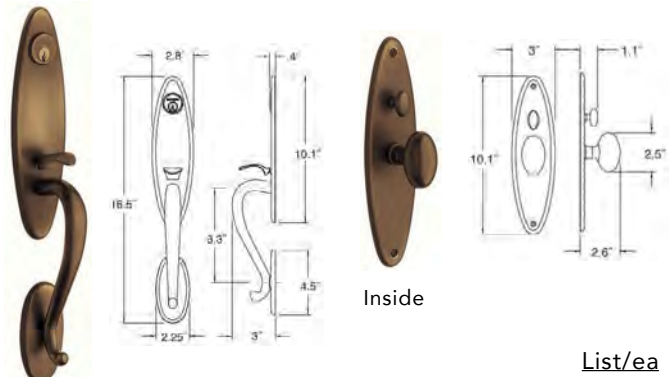

Outside

Entry Trim

List/ea  
 \$ 723

**KENSINGTON TRIM - 6950**

Use 8323 Cylinder

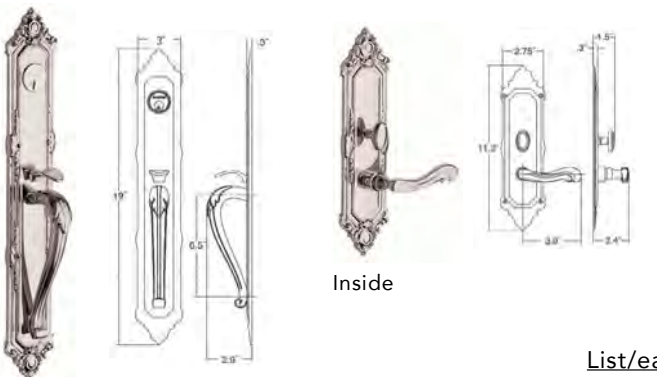

Outside

Entry Trim

List/ea  
 \$ 1161

**CONCORD TRIM - 6571**

Use 8323 Cylinder

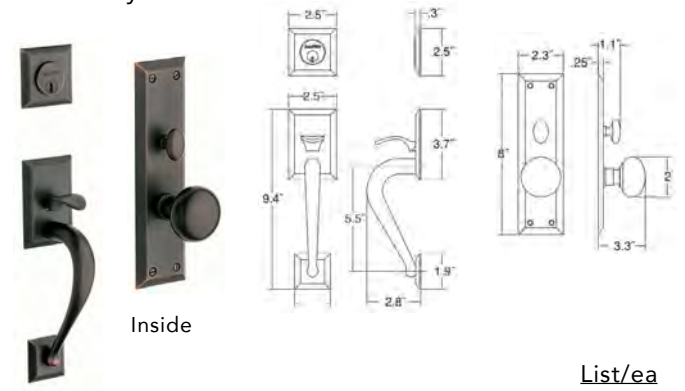

Outside

Entry Trim

List/ea  
 \$ 723



**BALDWIN ESTATES**

**ENTRANCE TRIM**

**BALDWIN ENTRANCE TRIM**

Prices for Trim Only. Order Mortise Box and Cylinder separately. See Finish Codes page 306.  
 Some items available for Quick Ship. Full Dummy Trim priced the same.

**PALM SPRINGS TRIM - 6921**

Use 8323 Cylinder

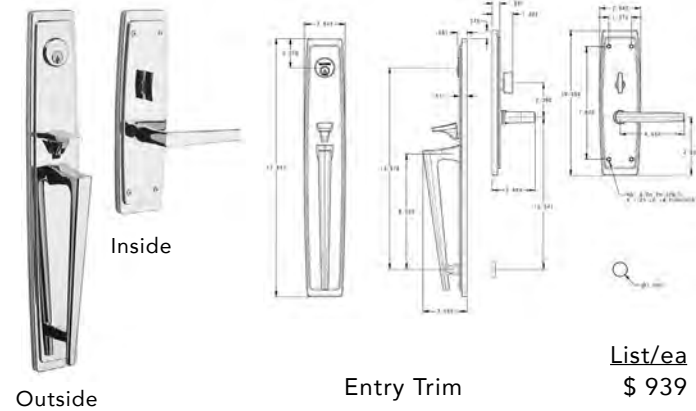

List/ea  
 \$ 939

**PASADENA TRIM - 6944**

Use 8323 Cylinder

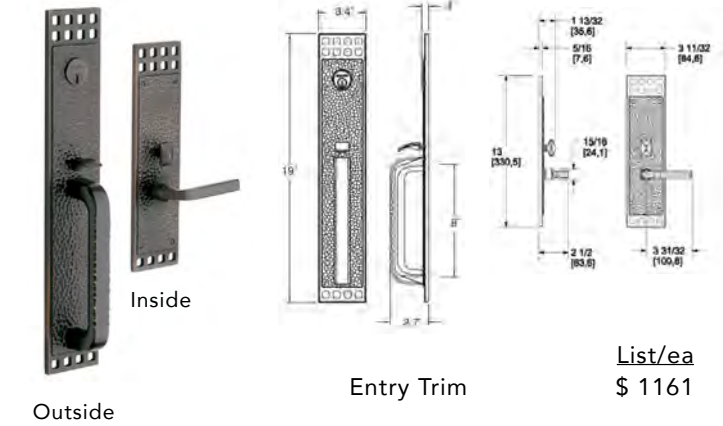

List/ea  
 \$ 1161

**BALDWIN EXTERIOR KNOB SETS**

**BARCLAY DESIGN - 6554**

Use 8323 Cylinder

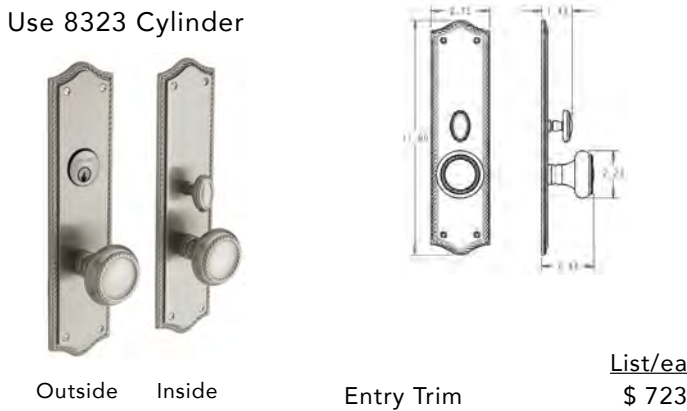

List/ea  
 \$ 723

**BALTIMORE DESIGN - 6552**

Use 8322 Cylinder

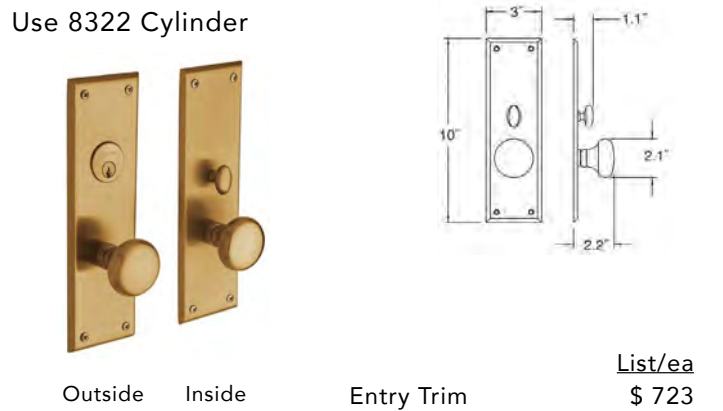

List/ea  
 \$ 723

**NASHVILLE - 6547**

Use 8322 Cylinder

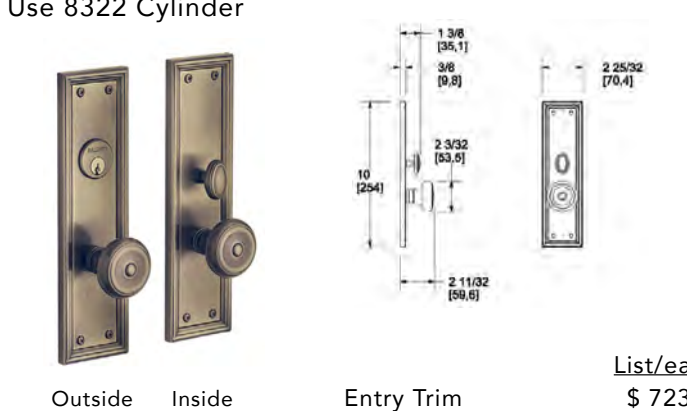

List/ea  
 \$ 723

**HOLLYWOOD HILLS - 6945**

Use 8323 Cylinder

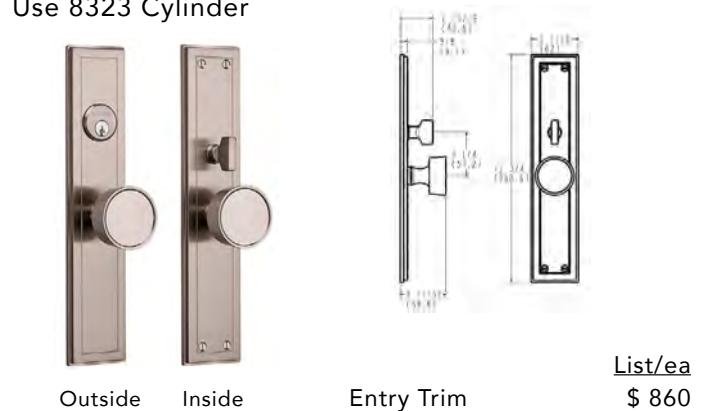

List/ea  
 \$ 860

**ENTRANCE TRIM**

**BALDWIN ESTATES**

**BALDWIN ENTRANCE TRIM**

Prices for Trim Only. Order Mortise Box and Cylinder separately. See Finish Codes page 306.  
 Some items available for Quick Ship. Full Dummy Trim priced the same.

**3 BALDWIN EXTERIOR LEVER SETS**

**BISMARK - 6942**

Use 8322 Cylinder

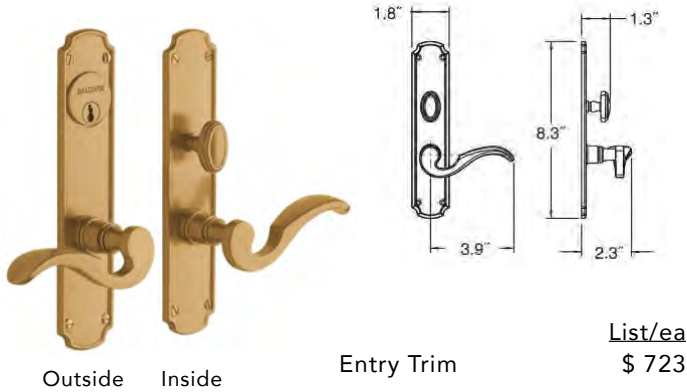

**SANTA MONICA - 6915**

Use 8323 Cylinder

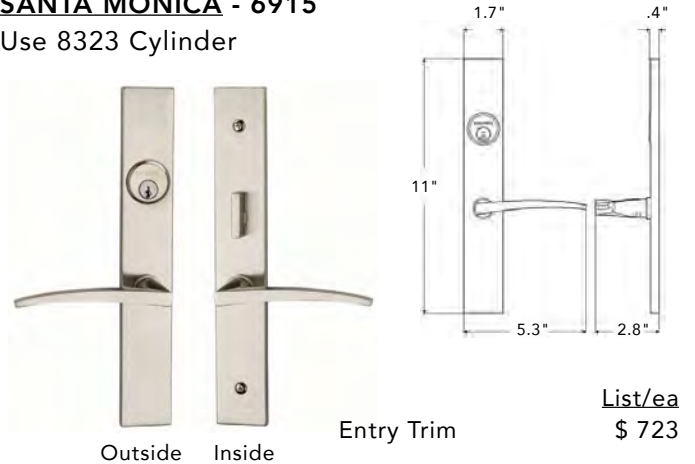

**HOUSTON - 6973**

Use 8324 Cylinder

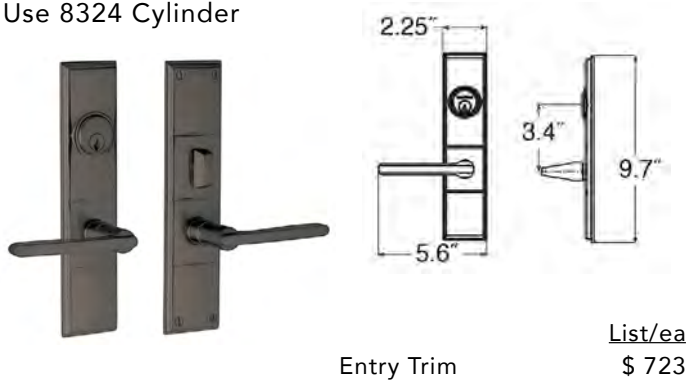

## BALDWIN ESTATES

## MORTISE LOCKS

### BALDWIN MORTISE LOCKS - HANDLESETS

*Important:* Please read the following instructions before Ordering Baldwin Mortise Lock Handlesets.

When Ordering a Baldwin Mortise Lock with a Handleset on one side and a Knob or Lever on the other side, the following information must be given: First give the stock number for the design of the desired exterior handle and interior knob trim combination, and then give the stock number for the desired lock function.

Second, give the hand of the door, the door thickness (if different than 1-3/4"), the finish of the lock, and the cylinder number. For example, a 'Lexington' design with a 'Residential Entrance' function for a 1-3/4" right hand door with a 2-3/4" backset, in a Bright Brass Finish would be written as:

1 ea. 6560-003	Trim
1 ea. 6021-003 RHLC	Mortise Lock
1 ea. 8323-003	Cylinder

Please note that the trim lock functions are priced separately and must be added together for the total price. The 2-1/2" Backset lock functions are to be used on doors with stiles of 4" (or greater). To order DUMMY TRIM give the Handleset design number and follow it by the letters 'FD', i.e. 6560-030 FD - no lock functions necessary for dummies. If you do not want the inside knob that comes with the handles, other knobs may be substituted and ordered special from the factory.

### HOW TO HAND A DOOR

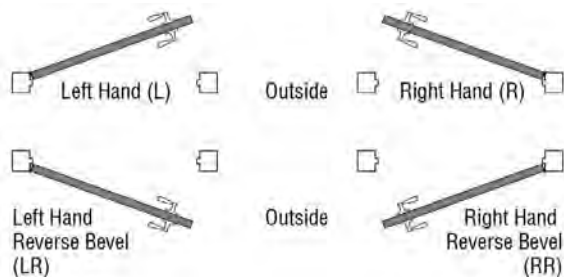

Here are a few rules to follow:

1. The outside of an exterior door is the street/entrance side.
2. The outside of a room door is the hall side.
3. The outside of a single communicating door is the side from which the hinges are not visible when the door is closed.
4. The outside of a closet door is the room or hall side.

### BALDWIN HEAVY DUTY MORTISE LOCKS

#### Case Dimensions

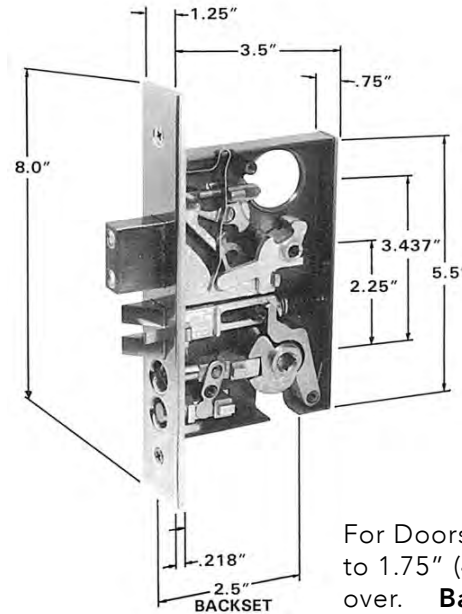

For Doors 1.375" (35mm) to 1.75" (44mm) thick & over. **Backset: 2-1/2"**

#### #6321 Case

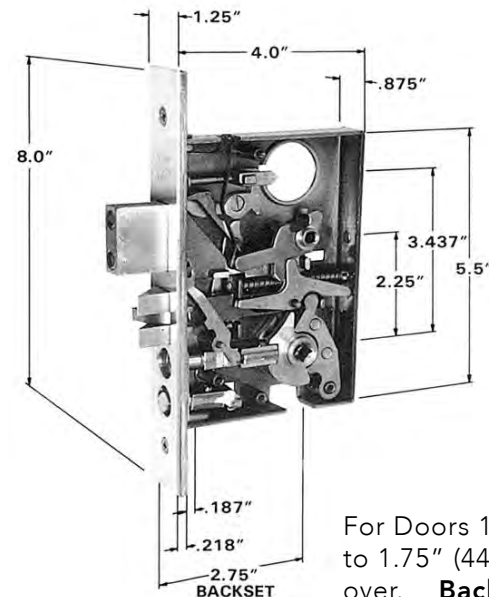

For Doors 1.375" (35mm) to 1.75" (44mm) thick & over. **Backset: 2-3/4"**

#### #6021 Case

## MORTISE LOCKS

## BALDWIN ESTATES

### HANDLESET X KNOB RESIDENTIAL ENTRANCE

"Panic Proof"

3

Latch bolt by thumbpiece outside and knob inside, except when thumbpiece is locked by stop in front; then latch bolt by key outside & knob inside. Deadbolt by key outside & turn piece inside. When deadbolt is thrown, stop is automatically activated making outside thumbpiece rigid. Inside knob retracts latch and deadbolt simultaneously but DOES NOT free outside thumb piece.

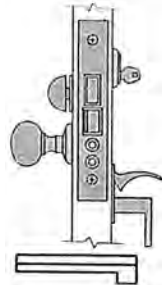

Inside Outside  
Knob

1" throw deadbolt with saw-proof inserts is standard. When extended, deadbolt deadlocks latch bolt.

#### Backset: 2-3/4"

Code	Handing	List/ea
6021-... LHLC	Left Hand	\$ 504
6021-... RHLC	Right Hand	504

Finishes Available:

003, 050, 060, 102, 112, 150, 151, 260

#### Backset: 2-1/2"

Code	Handing	List/ea
6321-... LHLC	Left Hand	\$ 504
6321-... RHLC	Right Hand	504

Finishes Available:

003, 050, 060, 102, 112, 150, 151, 260, 264

Mortise locks NOT available in Distressed finishes, non-distressed equivalents:

402 = 102  
 412 = 112  
 452 = 152 or 151

Other finishes and Special Functions available Special Order

### HANDLESET X LEVER RESIDENTIAL ENTRANCE

"Panic Proof"

Latch bolt by thumbpiece outside and lever inside, except when thumbpiece is locked by stop in front; then latch bolt by key outside & lever inside. Deadbolt by key outside & turn piece inside. When deadbolt is thrown, stop is automatically activated making outside thumbpiece rigid. Inside lever retracts latch and deadbolt simultaneously but DOES NOT free outside thumb piece.

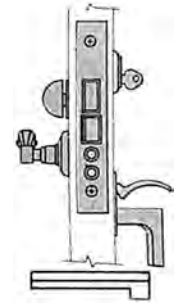

Inside Outside  
Lever

1" throw deadbolt with saw-proof inserts is standard. When extended, deadbolt deadlocks latch bolt.

#### Backset: 2-3/4"

Code	Handing	List/ea
6021-... LHLC LS	Left Hand	\$ 504
6021-... RHLC LS	Right Hand	504

Finishes Available:

003, 102, 112, 150, 151

#### Backset: 2-1/2"

Code	Handing	List/ea
6321-... LHLC LS	Left Hand	\$ 504
6321-... RHLC LS	Right Hand	504

Finishes Available:

003, 050, 102, 112, 150, 151, 260

Mortise locks NOT available in Distressed finishes, non-distressed equivalents:

402 = 102  
 412 = 112  
 452 = 152 or 151

Other finishes and Special Functions available Special Order

#### Finish Codes (Also see page 306)

003 - Lifetime Pol. Brass	050 - Satin Brass/Black	060 - Satin Brass/Brown	102 - Oil R Bronze
033 - Vintage Brass	150 - Satin Nickel	260 - Pol. Chrome	190 - Satin Black
112 - Venetian Bronze	031 - Non-laq Brass	044 - Lifetime Satin Brass	056 - Lftm Sat Nickel

All Lock Prices are Without Cylinder. Order Cylinder Separately.



## BALDWIN ESTATES

## MORTISE LOCKS

### KNOB X KNOB RESIDENTIAL ENTRANCE

"Panic Proof"

Latch bolt by knob from either side, except when outside knob is locked by stop in front; then latch bolt by key outside and knob inside. Deadbolt by key outside and turn piece inside. When deadbolt is thrown, stop is automatically activated making outside knob rigid. Inside knob retracts latch and deadbolt simultaneously but DOES NOT free outside knob.

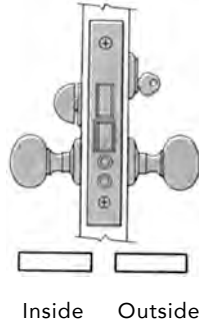

1" throw deadbolt with saw-proof inserts is standard. When extended, deadbolt deadlocks latch bolt.

#### **Backset: 2-3/4"**

Code	Handing	List/ea
6075-... LHLC	Left Hand	\$ 504
6075-... RHLC	Right Hand	504

Finishes Available:  
003, 102, 260

#### **Backset: 2-1/2"**

Code	Handing	List/ea
6375-... LHLC	Left Hand	\$ 504
6375-... RHLC	Right Hand	504

Finishes Available:  
003, 060, 102, 150, 264

Other finishes and Special Functions available Special Order

### LEVER X LEVER RESIDENTIAL ENTRANCE

"Panic Proof"

Latch bolt by lever from either side, except when outside lever is locked by stop in front; then latch bolt by key outside and lever inside. Deadbolt by key outside and turn piece inside. When deadbolt is thrown, stop is automatically activated making outside lever rigid. Inside lever retracts latch and deadbolt simultaneously but DOES NOT free outside knob.

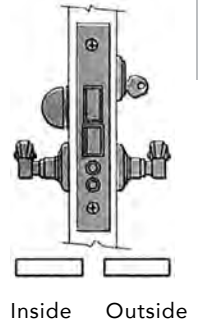

1" throw deadbolt with saw-proof inserts is standard. When extended, deadbolt deadlocks latch bolt.

#### **Backset: 2-3/4"**

Code	Handing	List/ea
6075-... LHLC LS	Left Hand	\$ 504
6075-... RHLC LS	Right Hand	504

Finishes Available:  
003, 102, 260

#### **Backset: 2-1/2"**

Code	Handing	List/ea
6375-... LHLC LS	Left Hand	\$ 504
6375-... RHLC LS	Right Hand	504

Finishes Available:  
003, 102, 150

Other finishes and Special Functions available Special Order

### Finish Codes (Also see page 306)

003 - Lifetime Pol. Brass	050 - Satin Brass/Black	060 - Satin Brass/Brown	102 - Oil R Bronze
033 - Vintage Brass	150 - Satin Nickel	260 - Pol. Chrome	190 - Satin Black
112 - Venetian Bronze	031 - Non-laq Brass	044 - Lifetime Satin Brass	056 - Lftm Sat Nickel

All Lock Prices are Without Cylinder. Order Cylinder Separately.



## NARROW BACKSET MORTISE LOCKS

## CYLINDERS

### LEVER X LEVER ENTRANCE & APARTMENT

Latch bolt by lever from either side, except when outside lever is locked by stop in front; then latch bolt by key outside & lever inside. Deadbolt by key outside & turn piece inside. Continuous turn of key outside retracts both latch and deadbolt.

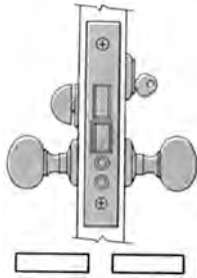

Inside      Outside

#### **Backset: 1-1/2"**

Code	Handing	List/ea
6800-... LHLC	Left Hand	\$ 504
6800-... RHLC	Right Hand	504

#### **Backset: 2"**

Code	Handing	List/ea
6802-... LHLC	Left Hand	\$ 504
6802-... RHLC	Right Hand	504

Specify Finish Number When Ordering. See finish codes page 306.

All Lock Prices are Without Cylinder. Order Cylinder Separately.

### BALDWIN MORTISE LOCK CYLINDERS

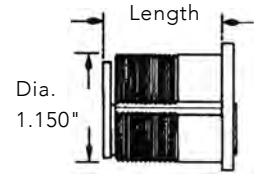

Baldwin 6 pin (5 pin for 1" (25mm)) precision mortise cylinders are made of solid extruded brass. Finish is applied to cap only. When ordered separately, cylinders are supplied with 2 nickel silver keys.

Length of Mortise Cylinders: The length of a Baldwin cylinder is the measurement from the back edge of the cylinder cap to the outer surface of the cam as illustrated.

Specify Finish Number When Ordering. See finish codes page 306.

Code	Cylinder Length	List/ea
8321-	1"	\$ 82
8322-	1.125"	82
8323-	1.25"	82
8324-	1.375"	82
8325-	1.5"	82
8326-	1.625"	\$ 169
8327-	1.75"	169
8328-	2"	169

Cylinders NOT available in Distressed finishes, non-distressed equivalents:

- 402 = 102
- 412 = 112
- 452 = 152 or 151



## BALDWIN ACCESSORIES

### FORGED BRASS TURN PIECES w/ BACKPLATES

Baldwin turn pieces can be used with any Baldwin mortise lock which has a deadbolt. They can also be substituted for the standard turn piece on mortise bolts 0418 and 0419. See finish codes page 306.

The following turn pieces will accommodate doors up to 2-1/4".

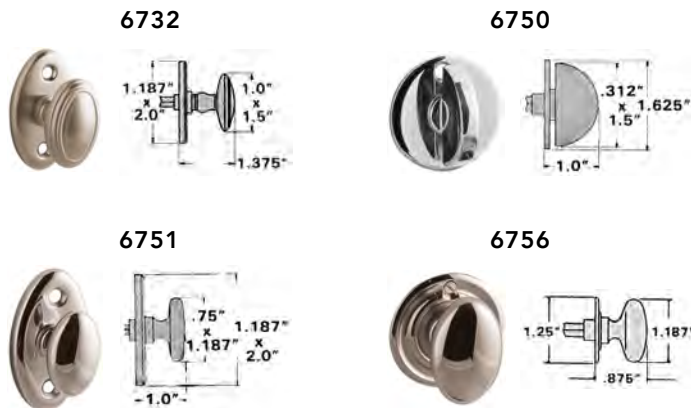

The following turn pieces will accommodate doors up to 3".

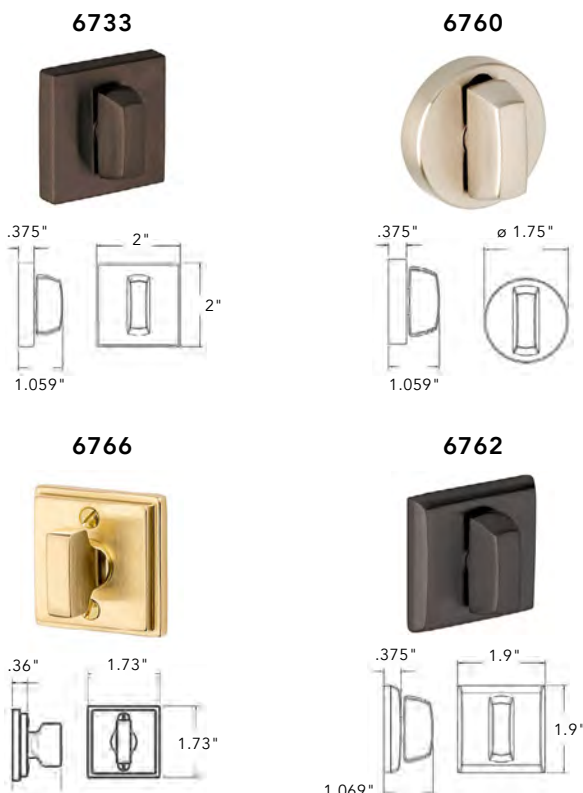

All Turn Pieces shown above

List/ea  
\$ 95

### MORTISE LOCK CYLINDER TRIM

Baldwin cylinder trim will fit any Baldwin mortise cylinder. Cylinder not included. See finish codes pg 306.



Code	Description	List/ea
6737-...	Square Trim	\$ 66
6738-...	Cont. Round Trim	66
6739-...	Lakeshore Trim	66
6743-...	Cont. Square Trim	66
6754-...	Oval Trim	66
6757-...	Colonial Trim	66
6755-...	Cylinder Cover Plate	140
6761-...	Dummy Cylinder	66
8300-...	Compression Cylinder Collar	25

## INTERIOR MORTISE LOCKS

## BALDWIN ESTATES

### INTERIOR MORTISE LOCKS - SMALL CASE

Backset: 2-1/2" Smooth, rapid action.

- Quick and easy install on pre-prepared doors
- Heavy gauge steel case, solid forged brass interior working parts
- Completely reversible for all door conditions
- Turn pieces and Emergency Release Trim must be ordered separately
- Due to 2-1/4" spacing, not all Baldwin rosettes and ER trim will fit. To verify fit, add 1/2" height of rose and 1/2" height of ER trim, total cannot exceed 2-1/4"

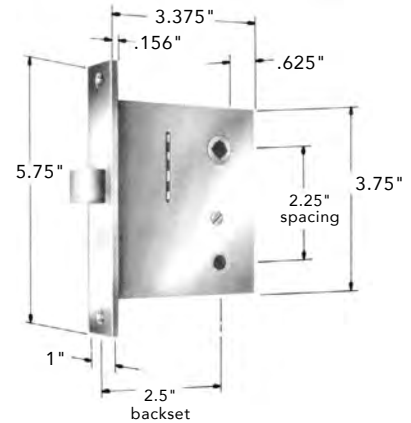

Specially designed curved lip strike is fully reversible (non-handed); available in 1-1/4" Lip to Center dimension only. Dust box is furnished unattached; conceals installation marks and cutouts.

Packed: One mortise lock with a strike, dust box, fasteners and 3.5" spindle.

### 8530 - PASSAGE KNOB LOCK

Specify Finish / Handing

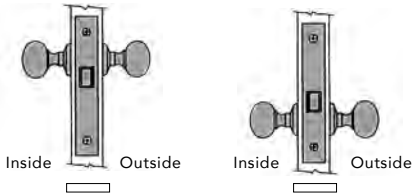

Locks are supplied as illustrated in left hand image To install as illustrated in right hand image, specify the **OPPOSITE HAND OF THE DOOR.**

Passage Interior Mortise Lock. Knob x Knob.  
 2-1/2" Backset. See page 306 for finish codes.

<u>Code</u>	<u>List/ea</u>
8530-... LH	\$ 233
8530-... RH	233

### 8540 - PRIVACY KNOB LOCK

Specify Finish / Handing

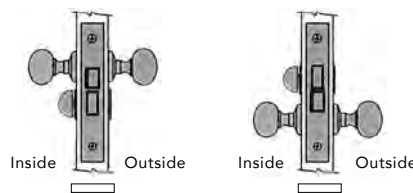

Locks are supplied as illustrated in left hand image To install as illustrated in right hand image, specify the **OPPOSITE HAND OF THE DOOR.**

Privacy Interior Mortise Lock. Knob x Knob.  
 2-1/2" Backset. See page 306 for finish codes.

<u>Code</u>	<u>List/ea</u>
8540-... LH	\$ 233
8540-... RH	233

### 8535 - PASSAGE LEVER LOCK

Specify Finish / Handing

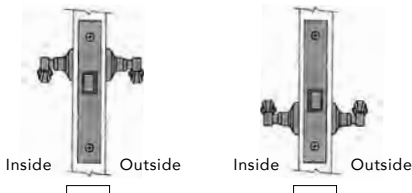

Locks are supplied as illustrated in left hand image To install as illustrated in right hand image, specify the **OPPOSITE HAND OF THE DOOR.**

Passage Interior Mortise Lock. Lever x Lever.  
 2-1/2" Backset. See page 306 for finish codes.

<u>Code</u>	<u>List/ea</u>
8535-... LH	\$ 233
8535-... RH	233

### 8545 - PRIVACY LEVER LOCK

Specify Finish / Handing

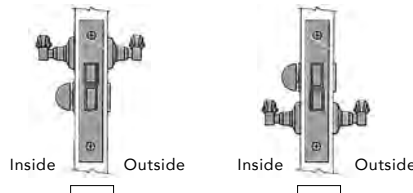

Locks are supplied as illustrated in left hand image To install as illustrated in right hand image, specify the **OPPOSITE HAND OF THE DOOR.**

Privacy Interior Mortise Lock. Lever x Lever.  
 2-1/2" Backset. See page 306 for finish codes.

<u>Code</u>	<u>List/ea</u>
8545-... LH	\$ 233
8545-... RH	233





## BALDWIN ESTATES

## INTERIOR MORTISE LOCKS - HEAVY DUTY

### PASSAGE FOR LEVERS

Latch bolt by lever either side.  
No cylinder necessary.

See finish codes page 306.

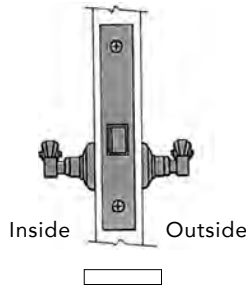

#### Backset: 1-1/2"

Code	Handing	List/ea
6855-... LH	Left hand	\$ 444
6855-... RH	Right hand	444

#### Backset: 2"

6857-... LH	Left hand	\$ 444
6857-... RH	Right hand	444

#### Backset: 2-1/2"

6318-... LH LS	Left hand	\$ 444
6318-... RH LS	Right hand	444

#### Backset: 2-3/4"

6110-... LH LS	Left hand	\$ 444
6110-... RH LS	Right hand	444

### PASSAGE FOR KNOBS

Latch bolt by lever either side.  
No cylinder necessary.

See finish codes page 306.

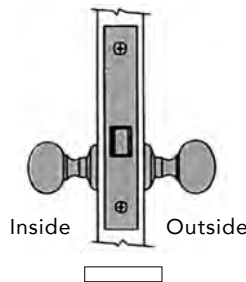

#### Backset: 2-1/2"

Code	Handing	List/ea
6318-... LH	Left hand	\$ 444
6318-... RH	Right hand	444

#### Backset: 2-3/4"

6110-... LH	Left hand	\$ 444
6110-... RH	Right hand	444

### PRIVACY FOR LEVERS

Latch bolt by lever either side.  
Deadbolt by turn piece inside  
and emergency key 0417 outside.  
1" throw deadbolt with saw proof  
inserts is standard. When extend-  
ed, deadbolt deadlocks latch  
bolt. No cylinder necessary.

See finish codes page 306.

#### Backset: 1-1/2"

Code	Handing	List/ea
6845-... LH	Left hand	\$ 444
6845-... RH	Right hand	444

#### Backset: 2"

6847-... LH	Left hand	\$ 444
6847-... RH	Right hand	444

#### Backset: 2-1/2"

6315-... LH LS	Left hand	\$ 444
6315-... RH LS	Right hand	444

#### Backset: 2-3/4"

6100-... LH LS	Left hand	\$ 444
6100-... RH LS	Right hand	444

### PRIVACY FOR KNOBS

Latch bolt by knob either side.  
Deadbolt by turn piece inside  
and emergency key 0417 outside.  
1" throw deadbolt with saw proof  
inserts is standard. When extend-  
ed, deadbolt deadlocks latch  
bolt. No cylinder necessary.

See finish codes page 306.

#### Backset: 2-1/2"

Code	Handing	List/ea
6315-... LH	Left hand	\$ 444
6315-... RH	Right hand	444

#### Backset: 2-3/4"

6100-... LH	Left hand	\$ 444
6100-... RH	Right hand	444

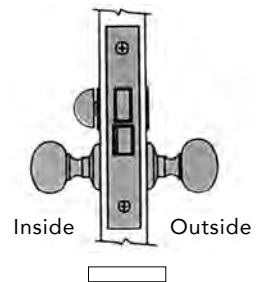
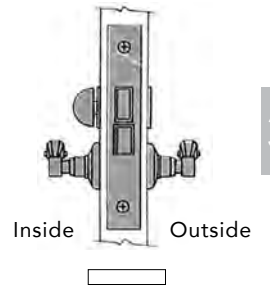

## BALDWIN LATCHES

### INTERIOR TUBULAR LATCH SETS

See finish codes page 306

2-3/8" Backset

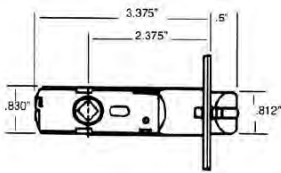

2-3/4" Backset

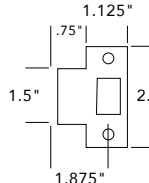
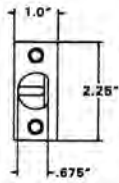
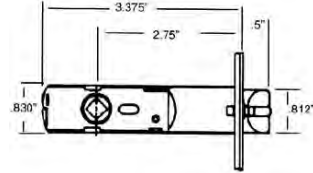

Standard Box  
T-Strike



### PASSAGE LATCHES

5510, 5513 = 2-3/8" Backset  
 5520, 5523 = 2-3/4" Backset

Includes: Standard Box T-Strike, fasteners, dust box and spindle.

#### For Interior Passage Knob Sets

Code	Description	List/ea
5510-...	2-3/8" BS, Knob Strength	\$ 82
5520-...	2-3/4" BS, Knob Strength	82

#### For Interior Passage Lever Sets

5513-...	2-3/8" BS, Lever Strength	\$ 82
5523-...	2-3/4" BS, Lever Strength	82

### PRIVACY LATCHES

5510 P, 5513 P = 2-3/8" Backset  
 5520 P, 5523 P = 2-3/4" Backset



Includes: Standard Box T-Strike, fasteners, dust box and spindle.

#### For Interior Privacy Knob Sets

Code	Description	List/ea
5510-... P	2-3/8" BS, Knob Strength	\$ 82
5520-... P	2-3/4" BS, Knob Strength	82

#### For Interior Privacy Lever Sets

5513-... P	2-3/8" BS, Lever Strength	\$ 82
5523-... P	2-3/4" BS, Lever Strength	82

## BALDWIN MORTISE BOLTS

### PRIVACY TUBULAR MORTISE BOLTS

See finish codes page 306

#### Contemporary Style

0418 = 2-3/8" Backset  
 0413 = 2-3/4" Backset

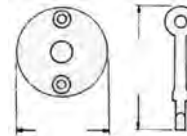
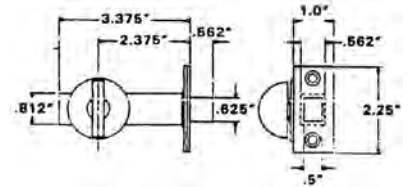

Emergency Release  
Key and Trim Set  
For 0418 and 0413  
Mortise Bolts

0415

Code	Description	List/ea
0418-...	2-3/8" Backset, Mortise Bolt	\$ 113
0413-...	2-3/4" Backset, Mortise Bolt	113
0415-...	Emergency Release Key Set	62

#### Traditional Style

0419 = 2-3/8" Backset  
 0414 = 2-3/4" Backset

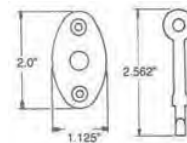
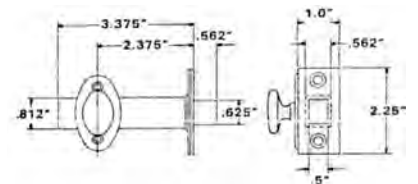

Emergency Release  
Key and Trim Set  
For 0419 and 0414  
Mortise Bolts

0416

Code	Description	List/ea
0419-...	2-3/8" Backset, Mortise Bolt	\$ 113
0414-...	2-3/4" Backset, Mortise Bolt	113
0416-...	Emergency Release Key Set	62

### MORTISE BOLTS WITHOUT TURN PIECE

Backset: 2-3/8"



Code	Description	List/ea
0418-... LTP	Mortise Bolt - without Turn Piece	\$ 45

## BALDWIN PARTS

## LATCH STRIKES

### STANDARD BOX T-STRIKE

Size: .062" x 1.125" x 2.75". Lip to Center: 1.312".  
 Dust box furnished unattached.

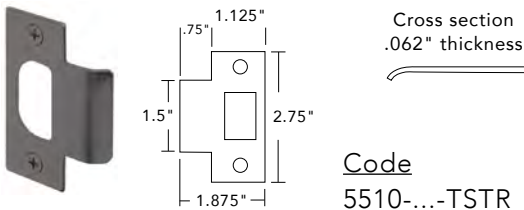

Code                      List/ea  
 5510-...-TSTR              \$ 22

### ASA STRIKE

Size: .093" x 1.125" x 4.875". Lip to Center: 1.25".  
 Dust box not furnished.

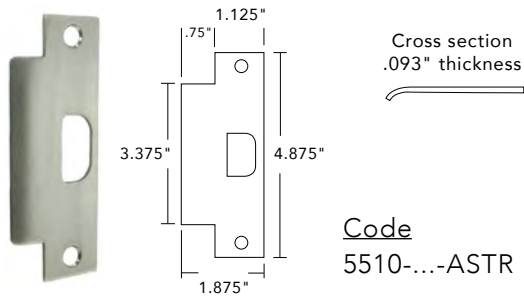

Code                      List/ea  
 5510-...-ASTR              \$ 22

### FULL LIP STRIKE

Size: .050" x 1.625" x 2.25". Lip to Center: 1.125".  
 Dust box not furnished.

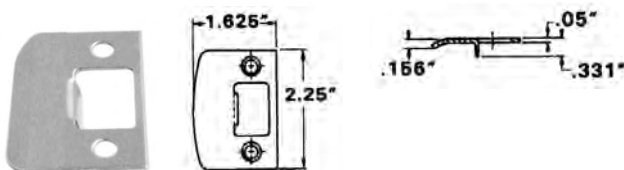

Code                      List/ea  
 5510-...-FSTR              \$ 22

### EXTENDED FULL LIP STRIKE

Size: .050" x 1.875" x 2.25". Lip to Center: 1.375".  
 Strike designed for 2" and 2-1/4" thick doors.

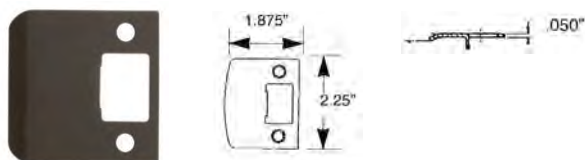

Code                      List/ea  
 5300-...-EFLS              \$ 22

### EXTENDED LIP T-STRIKE

Size: .062" x 1.25" x 2.75"

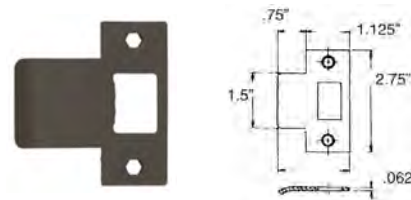

Code	Lip to Center	List/ea
5510-...-E158	1.625"	\$ 22
5510-...-E178	1.875"	22
5510-...-E214	2.25"	22

### COMBINATION PRIVACY STRIKE

Size: .093" x 1.062" x 5". Lip to Center: 1.281". Use with dust boxes furnished w/ tubular latches & mortise bolts. Strike permits the use of tubular latches & mortise bolts with escutcheons only. No. 0417 Emergency Key is included. Specify finish and handing.

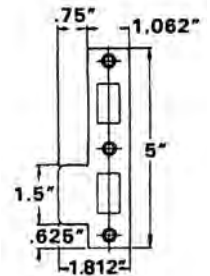

Code	List/ea
5528-...	\$ 22

### ASA LATCH/DEADBOLT STRIKE

Residential Entrance, Emergency Egress

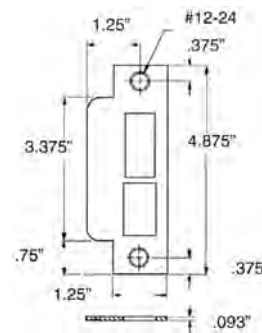

6040 - For locks with a .625" wide latch bolt.  
 6340 - For locks with a .5" wide latch bolt.

Code	List/ea
6040-...	\$ 45
6340-...	45

With curved lip, specify hand.

Code	List/ea
6340-...XX	\$ 45

3

## LATCH STRIKES

### ASA EXTENDED LIP STRIKE

Use with locks installed on special door and frame conditions. Supplied with a curved lip only. With screws. Lip to Center Length determined by following formula: Door Thickness ÷ 2 + .375, round to closest size.

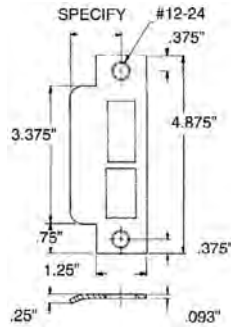

2.75" Backset Latch, Deadbolt  
 Latch width: 5/8". Specify hand and finish.

Code	Lip to Center	List/ea
6039-...-L(R)158	1-5/8"	\$ 95

1.5", 2", 2.5" Backset Latch, Deadbolt  
 Latch width: 1/2". Specify hand and finish.

6339-...-L(R) 158	1-5/8"	\$ 95
6339-...-L(R) 178	1-7/8"	95
6339-...-L(R) 214	2-1/4"	95

### BALDWIN THICK DOOR ADAPTER KITS

For Wood Doors up to 2.25" Thick

Allows Baldwin Estate (mortise) entry trim sets to accommodate wood doors greater than 1.75" and up to 2.25" thick.

Kit	Used for Trim #	List
6501-000-A	6515, 6520, 6526, 6540, 6541, 6543, 6549, 6556, 6557, 6560, 6564, 6565, 6567, 6568, 6570, 6571, 6572, 6573, 6931, 6946, 6948, 6950, 6963, 6976, 6977 - active & dummy	\$ 10
6501-000-B	6548, 6562, 6563, 6915 - active & dummy	32
6501-000-C	6920, 6921, 6944, 6952, 6999, M502, M504, M512, M514, M516, M522 - active & dummy	45
6501-000-D	6542, 6544, 6545 - active only	27
6501-000-E	6542, 6544, 6545 - dummy only	34
6501-000-F	6966, 6974	38

## EMERGENCY RELEASE TRIM

### BALDWIN EMERGENCY RELEASE TRIM

For use with Tubular Privacy Bolts and Privacy Mortise Locks. Trim sets provided with No. 0417 Emergency Release Key and No. 6701 Cover except for #0406 which only includes the key.

**Important:** To enable emergency trim to function, the turn piece spindle must be cut to extend no further than halfway through the bolt.

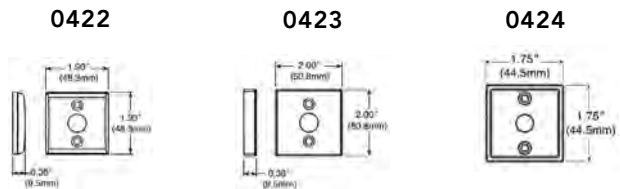
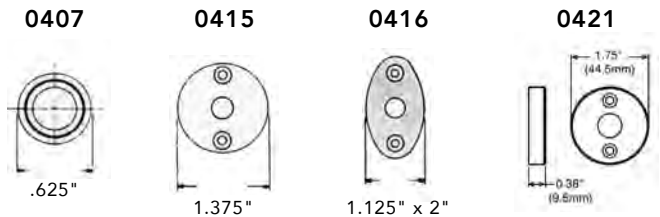
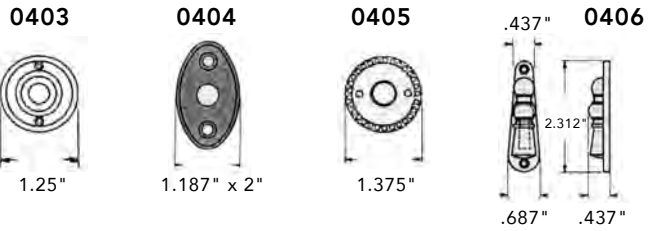

All Emergency Release Trim above List/ea \$ 62

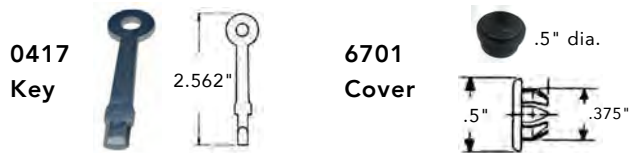

Code	Description	List/ea
0417	Emergency Release Key	\$ 10
6701-...	Emergency Release Cover	15
6703-...	Emergency Bit Key	51



## BALDWIN PARTS

3

### SOLID BRASS BACKPLATE

Designed for use with all Estates roses on active trim.

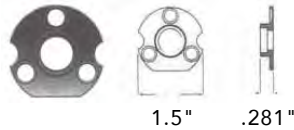

Code	Description	List/ea
5097-009-N	Active Trim Back Plate	\$ 13

### DUMMY TRIM BACKPLATE

Designed for use with all screwless roses on Half/Full Dummy applications.

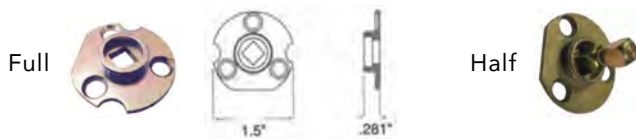

Code	Description	List/ea
5098	Full Dummy Backplate	\$ 13
5098-004	Half Dummy w/ Spindle	13

### DUMMY ADAPTER

For mounting escutcheons on Full Dummy applications (2 needed). 1.175" diameter.



Code	Description	List/ea
5099	Full Dummy Adapter	\$ 7

### DOOR ADAPTERS - 2-1/8" Cross Bore

Retrofits all 2.125" pre-bored doors allowing for Estate knob/lever installation. Works with Full Dummy, Passage and Privacy functions. Must use 2.625" or larger diameter rose/escutcheon to cover adapter. **MUST** be used if doors are pre-drilled.



Code	Description	List/ea
6503-009	Knob Strength	\$ 15
6504-009	Lever Strength	17

### ALIGNING TOOL & BUSHING

For use in proper alignment of knobs/levers and roses with mortise locks and tubular latches.



Code	Description	List/ea
8480-000	Aligning Tool	\$ 17

### PRIVACY BUTTON

Furnished with all privacy tubular latch sets.

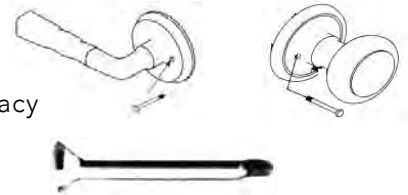

Code	Description	List/ea
5510-...-0030	Privacy Button for all Knob Strength latches	\$ 15
5513-...-0030	Privacy Button for all Lever Strength latches	15

### PRIVACY BUTTON EXTENDER

Use to extend length of privacy button in applications where hardware is installed on doors over 1.75" thick and/or with escutcheon plates thicker than .25".



5199-000  
List \$ 7

### ROSE RETAINER

Rose Retainers furnished standard with all Privacy Rosettes and Privacy Adapter Sets.

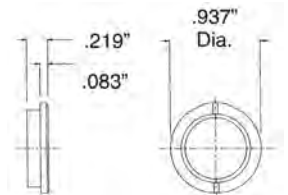

5197-000 List \$ 4

### SET SCREW

Included with all Estates Knobs and Lever Sets.



1327-009 List \$ 2

## BALDWIN PARTS

### HALF DUMMY RIGID MOUNTING SPINDLE

Special Order only.

Base Dia: 1".  
 Spindle length: 2.25".  
 Door thickness: 1.375"  
 For added strength and appearance on dummy applications.



Code	List/ea
5084-...	\$ 45

### CLOSET SPINDLES

Special Order only.

For the inside of closet doors and low frequency use doors.

CAUTION: Closet spindles are difficult to turn and should not be used where children, aged, or physically handicapped people may lock themselves within a small space.

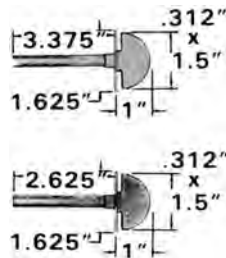

Code	Description	List/ea
6748-...	For 1.75" thick door 3.375" Spindle length	\$ 66
6749-...	For 1.375" thick door 2.625" Spindle length	66

### CLOSET SPINDLES FOR ADAPTERS

Special Order only.

For Pre-Drilled Doors. For the inside of closet doors and low frequency use doors in place of a knob or lever. Mounts with 6502.0009 Adapter.

CAUTION: Closet spindles are difficult to turn and should not be used where children, aged, or physically handicapped people may lock themselves within a small space.



Code	Description	List/ea
5081-...	For 1.375" thick door 2.625" Spindle length	\$ 66
5082-...	For 1.75" thick door 3.375" Spindle length	66

### HALF DUMMY SPINDLES

For mounting Estates knobs and levers to escutcheon plates.



Code	Size	List/ea
5077-004	1.5"	\$ 19
5091-004-A	.875"	19
5092-004-A	1.125"	19

### STRAIGHT SPINDLES - PASSAGE



Code	Size	List/ea
0509	3"	\$ 17
0510	3.5"	17
0511	4"	17
0512	4.5"	17
0513	5"	17
0514	5.5"	17
0515	6"	17
0516	7"	17

### SWIVEL SPINDLES - PRIVACY



Code	Size	List/ea
0520	3.5"	\$ 23
0521	4.5"	23
0522	4"	23
0523	5"	23
0524	5.5"	23
0525	6.5"	23

### HALF SPINDLES



For mounting all current Estates knobs and levers to thumbpiece of handlesets.

Code	Size	List/ea
0530-004	2.375"	\$ 17
0531-004	2.875"	17
0532-004	3.375"	17
0533-004	2.25"	17
0539-004	2.625"	17

## SCHLAGE "A" SERIES LOCKS

### "A" SERIES

ANSI Grade 2 (A156.2 Series 4000)

Applications: A Series - Heavy duty residential, light and medium commercial.

Keying: 6 pin tumbler with two keys per lock. Stock locks are keyed 5 pin.

Door Range: 1-3/8" to 1-7/8" standard.

Backset: 2-3/8" standard. Non standard - 2-3/4"

#### Standard Features

- Cylindrical lock housings. Cold rolled steel mechanisms, zinc dichromated for corrosion resistance.
- Demountable outside knobs for easy cylindrical replacement.
- Solid Brass six pin cylinders.
- No exposed mounting screws.
- Adjustable brass or bronze latch faceplates and strikes, furnished in compatible lock trim finishes.
- "A" Series locks are field reversible.

**PANIC PROOF:** Inside knob is always free.

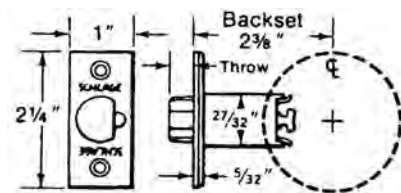

Cross Bore:  
2-1/8"

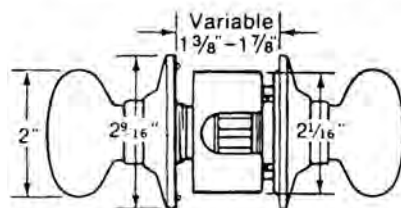

Edge Bore:  
7/8"



10-001 Standard T-Strike  
 Size: 2-3/4" x 1-1/8" x 3/32"  
 Lip: 1-1/8"  
 For 1-3/8" and 1-3/4" doors

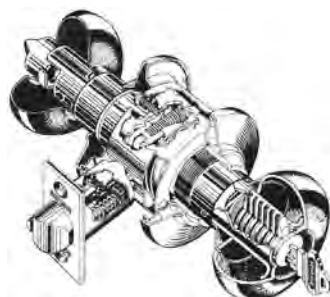

### PLYMOUTH KNOBS - "A" Series

Pack: 20/ctn.



#### PLYMOUTH

Symbol: PLY

Rose: 2-9/16" Dia.

Proj: 2-1/4"

Knob Dia: 2-3/16" outside,  
2-1/8" inside

Code	Function	Finish	List/ea
A170P605	Dummy, Sgl. Knob	605	\$ 95
A170P626	" " "	626	89
A10P605	Passage	605	190
A10P613	"	613	208
A10P626	"	626	178
A40P605	Privacy	605	190
A40P613	"	613	208
A40P626	"	626	178
A53P605	Entry	605	327
A53P613	"	613	345
A53P626	"	626	315
A80P626	Storeroom	626	315

Other styles and finishes available special order.

#### Finish Codes

- 605 - Bright Brass
- 613 - Oil R. Bronze
- 626 - Satin Chrome



## SCHLAGE "AL" SERIES

### "AL" SERIES COMMERCIAL LOCK SETS

For standard duty commercial interior and exterior doors, the "AL" series utilizes the Schlage original A-series cylindrical chassis supported by a heavy duty spring cage.

Certifications: ANSI A156.2, Series 4000 Grade 2. UL Listed for all functions up to 3-hour doors. Levers meet ADA standards and CA fire codes.

6 pin tumbler with 2 keys per lock.

Door Range: 1-3/8" to 1-7/8" standard.

Backset: 2-3/4" standard.

Latches are adjustable for flat or bevelled doors.

Standard square corner strike is the 10-025 with a 1-3/16" lip. Strike size is 1-1/4" x 4-7/8". Roses are wrought brass and bronze. Levers are pressure cast plated zinc. "AL" Series locks are field reversible.

### SCHLAGE HANDING CHART

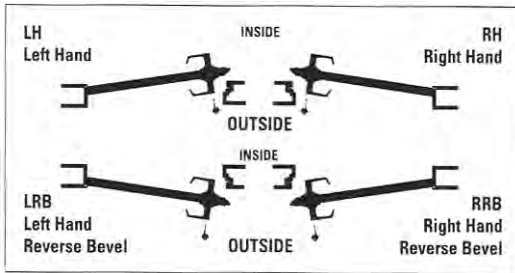

When standing outside a room or house and facing the door: if hinges are on your right, order a RH lock, if hinges are on your left order a LH lock.

### SATURN LEVER "AL" Series

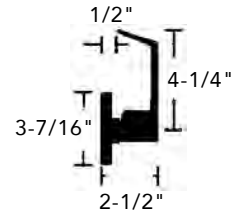

Code	Function	613	626
AL10SA	Passage	\$ 279	\$ 249
AL40SA	Privacy	312	282
AL170SA	Dummy	171	156
AL50SA	Entry/Office	381	351
AL53SA	Entry	381	351
AL70SA	Classroom	381	351
AL80SA	Storeroom	381	351

### SPARTA LEVER "AL" Series

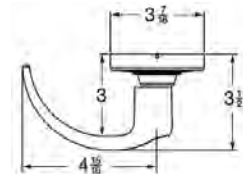

Code	Function	613	626
AL10SPA	Passage	\$ 301	\$ 271
AL40SPA	Privacy	334	304
AL170SPA	Dummy	182	167
AL50SPA	Entry/Office	403	373
AL53SPA	Entry	403	373
AL80SPA	Storeroom	403	373

Other styles and finishes available special order.

### Finish Codes

- 613 - Oil R. Bronze
- 626 - Satin Chrome



## SCHLAGE "B" SERIES DEADBOLTS

### SCHLAGE "B" SERIES DEADBOLTS

Standard and Heavy Duty

Hardened steel mounting screws, solid brass cylinders. Hardened steel rollers in stainless steel deadbolts. Prevent cutting and sawing attacks.

Installation: For hollow metal and wood doors and frames. Uniform application, completely reversible for RH or LH doors.

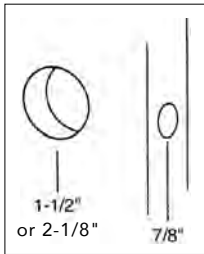

#### Door Prep

Cross Bore: 1-1/2" or 2-1/8"

Edge Bore: 7/8" or 1"

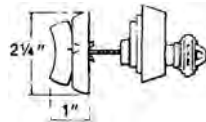

Keying: 5 pin tumbler "C" keyway.

Variable for 1-3/8" to 1-3/4" thick doors.

#### Square Corner Deadbolt Latch

1" x 2-1/4" Faceplate.

Strike plate: 1-1/8" x 2-3/4"

Std. latch except where noted.

Backset adjusts for 2-3/8" or 2-3/4".



#### Wood Frame Reinforcer - With All Deadbolts!

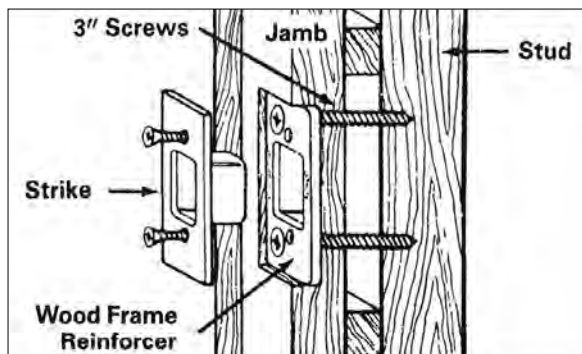

This Schlage patented device strengthens the wooden jamb against "kick-in" attack and enhances the strength of the lock mechanism. This exclusive product is concealed beneath the strike and is firmly anchored to the jamb with two 3" screws.

### STANDARD DUTY

B560 Series Deadbolts

Overall diameter: 2-1/2", Projection: 1-1/16", Cross Bore: 1-1/2". For residential and commercial. ANSI 156.5, 2001 Grade 2 certification.

#### SINGLE CYLINDER - 1" Throw

Deadbolt outside key cylinder, inside thumbturn. 7/8" dia. housing, Face-plate: 1" x 2-1/4". Backset adjusts for 2-3/8" or 2-3/4".



Code	Finish	Ctn	List/ea
B560P605	Bright Brass	4 ea.	\$ 119
B560P613	Oil R Bronze	4	129
B560P619	Satin Nickel	4	119
B560P625	Bright Chrome	4	119
B560P626	Satin Chrome	4	113

### SCHLAGE B250 DEADLATCH

Grade 2 Residential

With key cylinder outside, thumb turn inside. With a 1-1/8" square corner latch and strike. Holdback feature retains deadlatch in a retracted position when desired.

1" throw. Backset: 2-3/8".



Code	Finish	Ctn	List/ea
B250N605	Bright Brass	20 ea.	\$ 375
B250N613	Oil R Bronze	20	385
B250N626	Satin Chrome	20	369



## SCHLAGE "B" SERIES DEADBOLTS

### SCHLAGE B60 DEADBOLT

Grade 1 Residential

3



Key cylinder outside, thumb turn inside.  
Latch face: 1" x 2-1/4", round or square corner face plate, 7/8" housing dia, 1" throw. Adjustable Backset: 2-3/8" or 2-3/4". Rounded housing helps prevent sledge hammer break-ins. Dia: 2-1/2", Proj: 11/16", Cross Bore: 1-1/2" or 2-1/8" Edgebore: 1", Strike plate: 1-1/8" x 2-3/4".

### B60 Single Cylinder Deadbolt

<u>Code</u>	<u>Finish</u>	<u>Pack</u>	<u>List/ea</u>
B60N505	Lifetime Pol. Brass	Box Pk	\$ 79
B60N605	Bright Brass	Box Pk	71
B60N609	Antique Brass	Box Pk	79
B60N619	Satin Nickel	Box Pk	79
B60N625	Bright Chrome	Box Pk	79
B60N626	Satin Chrome	Box Pk	79

### SCHLAGE B660 HEAVY DUTY DEADBOLT

Grade 1 Commercial



Key cylinder outside, thumb turn inside.  
Latch: 1-1/8" x 2-1/4", Square corner faceplate, 1" housing, 1" throw. Dia: 2-1/2"  
Cross Bore: 1-1/2" or 2-1/8"  
Proj: 1". Pack 12 each.

### B660 Single Cylinder Deadbolt

<u>Code</u>	<u>Backset</u>	<u>Finish</u>	<u>List/ea</u>
B660613	2-3/8"	Oil R Bronze	\$ 297
B660626	2-3/8"	Sat. Chrome	281
B660613-2.75	2-3/4"	Oil R Bronze	297
B660626-2.75	2-3/4"	Sat. Chrome	281

## SCHLAGE "ND" SERIES

### "ND" SERIES HEAVY DUTY COMMERCIAL LOCKS

ANSI Grade 1

For High Frequency Traffic...the ultimate in durability combined with the finest mechanism and design. Levers meet ADA requirements. Rhodes and Sparta meet California fire codes.

#### Construction:

Mechanism - Heavy wrought steel zinc plated and dichromated with coil compression springs, roller bearings on latch retractors.

Exposed Trim and Parts - Wrought brass, bronze, or stainless steel.

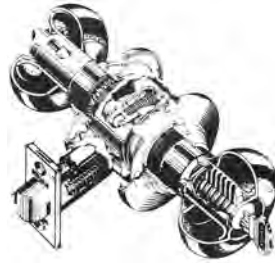

#### Keying:

Pin tumbler Cylinders - 6 pin tumbler extruded brass cylinder plugs and housing with nickel silver pins and keys, 6 pin keying.

#### Installation:

For Hollow Metal and Wood Door Frames. Uniform application regardless of function, completely reversible for RH or LH doors. For doors 1-5/8" - 2-1/8" thick with 1-1/8" lip strike. Faceplate: 1-1/8" x 2-1/4", Backset: 2-3/4".

"ND" Series - 2-3/4" Backset is Standard  
 Cross Bore: 2-1/8", Edge Bore: 1"

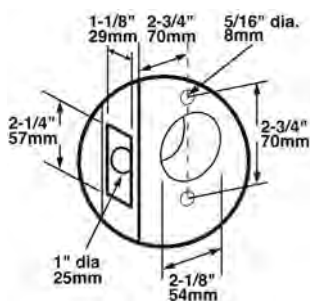
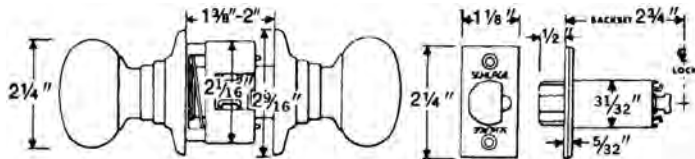

10-025  
 ANSI Strike:  
 Size: 1-1/4" x 4-7/8"  
 Lip: 1-3/16"

### RHODES Lever - "ND" Series

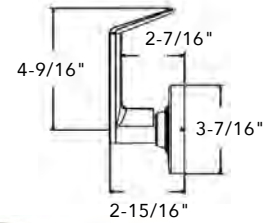

Code	Function	613	626
ND10R	Passage	\$ 632	\$ 602
ND40R	Privacy	723	693
ND170R	Dummy	183	168
ND50R	Office	850	820
ND53R	Entry	850	820
ND70R	Classroom	850	820
ND80R	Storeroom	850	820

### SPARTA Levers - "ND" Series

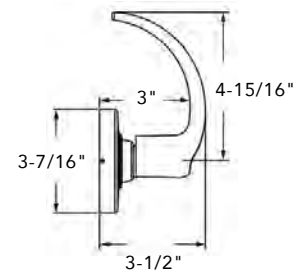

Code	Function	613	626
ND10S	Passage	\$ 632	\$ 602
ND40S	Privacy	723	693
ND50S	Office	850	820
ND53S	Entry	850	820
ND70S	Classroom	850	820
ND80S	Storeroom	850	820

#### Finish Codes

613 - Oil R. Bronze, 626 - Satin Chrome

## SCHLAGE "F" SERIES LOCKS

### SCHLAGE "F" SERIES LOCKS

Standard Duty Residential ANSI Grade 2

#### Construction:

3 Engineered for easy installation & durability. Cold rolled steel mechanisms with independent knob & latch springs, all zinc plated & dichromated. Wrought brass and bronze knobs and roses. 1/2" throw dead-locking anti-shim latchbolt.

Keying: Five pin "C" keyway.

Panic Proof: Inside knob is always free.

#### Installation:

Completely reversible for RH or LH doors.

Cross Bore: 2-1/8". Adjustable backset fits 2-3/8" or 2-3/4". Edge Bore: 7/8".

Door Thickness: 1-3/8" - 1-3/4"

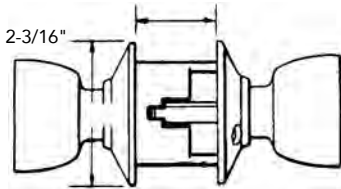

All "F" Series Packed with Round Radius latch and 10-027 round radius strike.

1/2" Throw Standard Backset

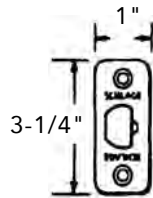
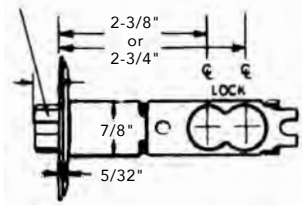

Round Radius



10-027  
 Full Lip,  
 1/4" Radius Corner Strike

### PLYMOUTH KNOB "F" Series



Symbol: PLY  
 Knob: 2-1/8" Dia.  
 Rose: 2-3/4"  
 Projection: 2-5/16"

#### Box Pack:

Code	Function	Finish	Ctn	List/ea
F170NP605	Dummy, 1 ea.	605	30	\$ 19
F170NP619	Dummy	619	30	22
F170NP625	Dummy	625	30	22
F170NP626	Dummy	626	30	22
F10NP605	Passage	605	30	39
F10NP619	Passage	619	20	41
F10NP625	Passage	625	20	41
F10NP626	Passage	626	20	41
F40NP605	Privacy	605	30	42
F40NP619	Privacy	619	30	44
F40NP625	Privacy	625	20	44
F40NP626	Privacy	626	20	44
F51NP505	Entry	505	20	68
F51NP619	Entry	619	20	68
F51NP625	Entry	625	20	68
F51NP626	Entry	626	20	68
F80NP605	Storeroom	605	20	75
F80NP626	Storeroom	626	20	80

#### Finish Codes

505 - Lifetime Brass      605 - Polished Brass  
 619 - Satin Nickel      625 - Pol. Chrome  
 626 - Satin Chrome



## SCHLAGE "F" SERIES LOCKS

### SCHLAGE "F" SERIES LOCKS

Standard Duty Residential ANSI Grade 2

#### **GEORGIAN KNOB** "F" Series

**Panic Proof**  
Inside Knob Always Free



Symbol: GEO  
Knob: 2-1/8" Dia.  
Rose: 2-3/4" Dia.  
Projection: 2-5/16"

**Box Pack:**

Code	Function	Finish	Ctn	List/ea
F170NG609	Dummy	609	30	\$ 22
F170NG619	Dummy	619	30	22
F10NG605	Passage	605	30	39
F10NG609	Passage	609	30	41
F10NG619	Passage	619	30	41
F40NG605	Privacy	605	30	42
F40NG609	Privacy	609	30	44
F40NG619	Privacy	619	30	44
F51NG505	Entry	505	20	64
F51NG609	Entry	609	20	68
F51NG619	Entry	619	20	68

#### **ORBIT KNOB** "F" Series



Symbol: ORB  
Knob: 2-1/8" Dia.  
Rose: 2-3/4" Dia.  
Projection: 2-7/8"

**Box Pack:**

Code	Function	Finish	Ctn	List/ea
F170NO625	Dummy	625	30	\$ 27
F170NO626	Dummy	626	30	27
F10NO625	Passage	625	30	53
F10NO626	Passage	626	30	53
F40NO625	Privacy	625	30	57
F40NO626	Privacy	626	30	57
F51NO625	Entry	625	20	80
F51NO626	Entry	626	20	80

#### **ACCENT LEVER** "F" Series



Symbol: ACC  
Lever Length: 4-1/8"  
Rose: 2-3/4" Dia.  
Projection: 2-1/4"

**Box Pack:**

Code	Function	Finish	Ctn	List/ea
F170NA619*	Dummy, 1 ea.	619	30	\$ 36
F10NA619	Passage	619	30	70
F10NA625	Passage	625	30	70
F40NA619	Privacy	619	30	73
F40NA625	Privacy	625	30	73
F51NA505	Entry	505	30	130
F51NA619	Entry	619	20	130
F51NA625	Entry	625	20	130

\* Specify handing on single dummies

#### **ELAN LEVER** "F" Series

**Panic Proof**



Symbol: ELA  
Lever Length: 3-7/8"  
Rose: 2-3/4" Dia.  
Projection: 2-7/16"

**Box Pack:**

Code	Function	Finish	Ctn	List/ea
F170NE626	Dummy	626	30	\$ 38
F10NE626	Passage	626	20	72
F40NE626	Privacy	626	20	76
F51NE626	Entry	626	20	130

Finish Codes

505 - Lifetime Brass	605 - Polished Brass
619 - Satin Nickel	620 - Antique Nickel
625 - Polished Chrome	626 - Satin Chrome



PANIC HARDWARE

VON DUPRIN

VON DUPRIN 88 SERIES RIM DEVICE



All Special Order

The sleek versatile 88 series is constructed of cast aluminum, bronze, and stainless steel. All devices in this series are UL rated for accident hazard and casualty hazard.

The patented 88 rim series is reversible and fits doors up to 3'8" wide. Roller strike #299 is included. Cylinders are also included; uses Von Duprin #3216 rim type with Schlage "C" keyway. Has dogging feature for push-pull operation. Packed stock-size knocked down, one per box.

Avail. Finishes: US26, US26D, US3, US4, US10B, US10, SPBLK

Dimensions

Table with dimensions for crossbar length, tubing, height, projection, and lock/hinge stile cases.

Table showing backset and minimum width of stile for various door types and trim.

\* When stop is 1/2"

88 SERIES STANDARD TRIM EO (Exit Only) - No Trim / See next page for jamb details



88NL Night Latch Key retracts latchbolt



88TP Thumb Piece Key locks thumbpiece



88DT Dummy Trim Pull when dogged



88K Knob Key locks knob

Table listing codes (88DT-4, 88EO-4, etc.) and list price per unit (Call for Pricing).

88 SERIES VERTICAL ROD DEVICES - All Special Order

These stylish vertical rod devices display quality of design, material, and workmanship. UL rated and reversible, they will fit doors up to 3'8" wide. Price includes cylinder.

Avail. Finishes: US26, US26D, US3, US4, US10B, US10, SPBLK

Patented features include a bottom latch which combines hinged bolt and deadbolt operations, and fits all conventional still conditions. Sets are furnished with 299 top strike and 248BL-4, 304L bottom strikes. Uses Von Duprin #3216 rim with Schlage "C" keyway cylinders. Dogging feature, packed stock size, knocked down, one set/box.

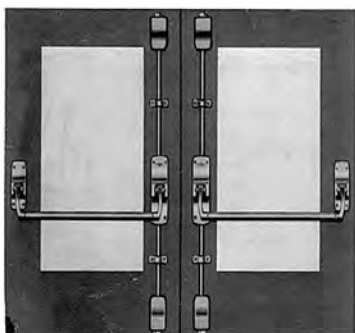

Inactive Active (specify trim)

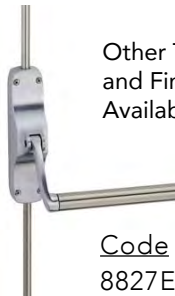

Other Trims and Finishes Available



Table with codes (8827EO-4, 8827TP-4, etc.) and list price (Call for Pricing).

List/ea



Dimensions

Table with dimensions for floating axles, crossbar length, height, projection, and vertical rods.

Double doors require divergent bevels



**VON DUPRIN**

**PANIC HARDWARE**

**VERTICAL ROD & RIM DEVICE COMBINATIONS - 88 SERIES**

3

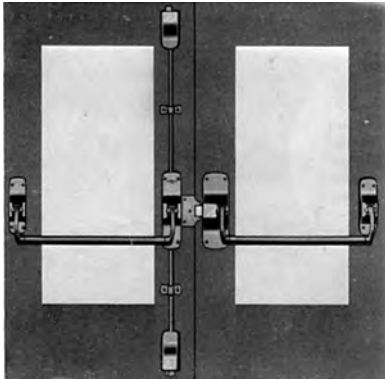

Inactive      Active

88 Series Single Door  
 w/ 299 Strike

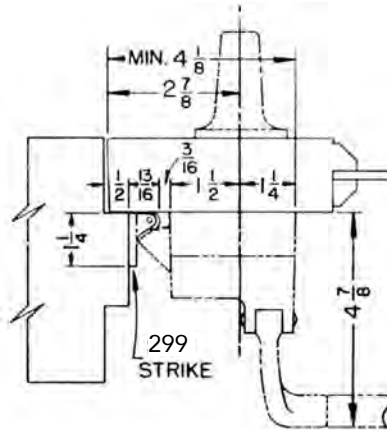

Strike adjusts up to 3/8"  
 for warpage of door

88 Series Double Door  
 w/ 1609 Strike

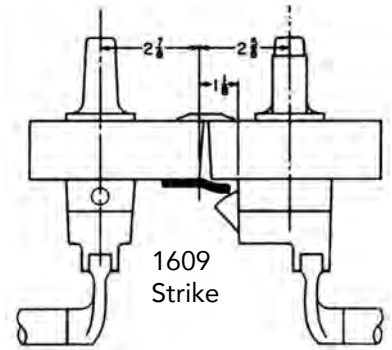

**DOUBLE DOORS** without mullions may be fitted with a combination of vertical rod and standard rim devices with the addition of the 1609 strike. 88 Series devices may be used in this way.

299 Strike  
 ships standard  
 with 88 rim device

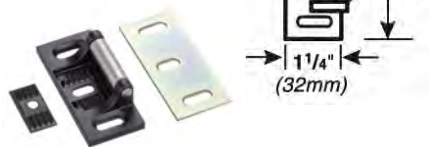

1609 Strike  
 Use for rim/vertical  
 rod combination

**Special Order**

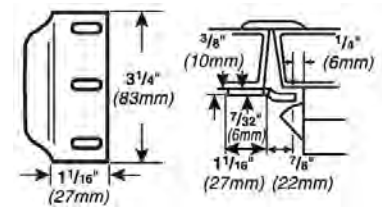

**DOOR HANDING**

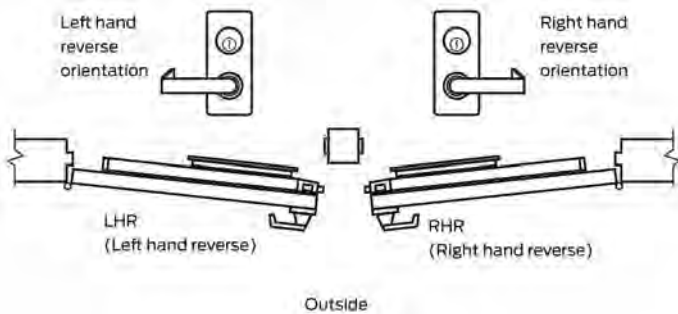

Code  
 1609-10  
 1609-26D

Finish  
 Dull Bronze  
 Dull Chrome

Call for  
 Pricing

## PANIC HARDWARE

### VON DUPRIN

#### 99 SERIES RIM / VERTICAL ROD DEVICE

##### All Special Order

3

99 Rim exit device (w/ grooved case) for all types of single and double doors with mullion, UL listed for panic exit hardware. **For Double Doors use 2 each Vertical Rod Devices, OR 2 each Rim Devices with a mullion.**

Devices are ANSI A156.3 – 2008 Grade 1. Rim device is non-handed except when the following device options are used: SD (special dogging), -2 (double cylinder) or SS (signal switch). Covers stock hollow metal doors with 86 or 161 cutouts on single doors (may cover cutouts on pairs – consult template).

Avail. Finishes: US3, US3A, US4, US4A, US10, US26, US26D, US26D-AM Antimicrobial, US28, 313, 315 & 643E.

#### 99 SERIES STANDARD TRIM EO (Exit Only) - No Trim

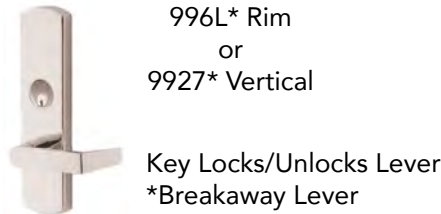

#### #99 Rim Device - For Wide Stile or Flush Doors



For Accident Hazard

#### #9927 Vertical Rod Device - Surface Mounted

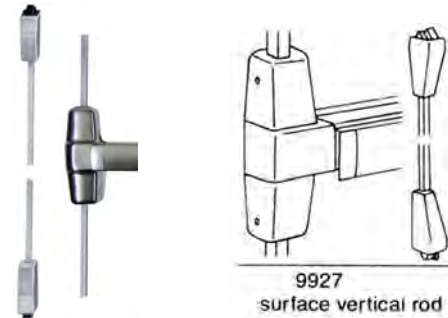

#### VON DUPRIN #99 RIM DEVICE All Special Order

For wide stile or flush doors. Non-handed. Field sizeable, 3/4" throw, latch bolt. Latch bolt is deadlocking. Hex key dogging. Keyed trim includes Schlage "C" cylinder.

Door Requirements: 2'6" - 3' wide.

Minimum Stile: 3-13/16", 1-3/4" thick.

Code	Finish	List/ea
99EO-26D	Dull Chrome	Call for Pricing
99EO-313	Duronodic Bronze	
99TP-26D	Dull Chrome	
99TP-313	Duro. Bronze	
99L-26D	Dull Chrome	
99L-313	Duro. Bronze	
4954	Mullion, up to 7' 2"	

#### VON DUPRIN #9927 SURFACE MOUNTED VERTICAL TYPE ROD DEVICE - All Special Order

For all types of single or double doors. Non-handed. Field sizeable, 5/8" throw & latch bolt, deadlocking latch bolt, hex key dogging. Keyed trim includes Schlage "C" cylinder.

Door requirements: 2'6" - 3' wide

Minimum Stile: 3-5/8", 1-3/4" thick, 7' high

Code	Finish	List/ea
9927EO-26D	Dull Chrome	Call for Pricing
9927EO-313	Duronodic Bronze	
9927TP-26D	Dull Chrome	
9927TP-313	Duro. Bronze	
9927L-26D	Dull Chrome	
9927L-313	Duro. Bronze	

\* The Breakaway Lever design allows the lever to break away and drop to the "down" position when abused, discouraging further abuse and protecting its internal parts. The "downed" lever can then be snapped back into an operable position easily, thus preventing needless loss of door operation and costly maintenance time.





## FIRE RATED, MORTISE, OR OTHER SPECIAL PANIC HARDWARE

### SPECIAL PANIC HARDWARE

Von Duprin devices may be ordered for FIRE RATED doors, MORTISE applications, NARROW stiles or situations requiring special trim functions, finishes, door alarms, or remote door control systems.

Please call for more information and quotes. Lead time is usually 1-2 weeks, however, some items may take longer.

#### **88-F Rim Fire Exit Device**

88-F fire exit rim devices for all types of 4' X 8' single and 8' X 8' double doors with 9954 mullion, UL listed, 3 hours. This device is handed.



#### **8875 Mortise lock exit device**

8875 mortise lock devices for all types of single or double doors, UL listed for accident hazard installations. Fits stock hollow metal doors with 86 cutouts and door stiles as narrow as 4 3/4". Field reversible but comes handed from factory. The 7500 mortise lock is equipped with a 3/4" anti-friction latch bolt which is field reversible without removing the lock from the door. It has a non-handed auxiliary bolt for deadlocking and a faceplate with an adjustable bevel.



8875 & 8875-F (also available Fire-Rated)

#### **99-F Rim Fire Exit Device**

99-F Rim fire exit devices for all types of single doors up to 4' x 10' or 8' x 10' double doors with 9954 or 9854 mullion, UL listed for fire exit hardware. Devices are ANSI A156.3 – 2008 Grade 1.



#### **9975 Mortise lock exit device**

9975 Mortise lock device for all types of single or double doors, UL listed for Panic exit hardware. Devices are ANSI A156.3 – 2008 Grade 1. Fits stock hollow metal doors with 86 cutout and door stiles as narrow as 4 3/4". The mortise lock device is non-handed except when the following device options are used: -2 (double cylinder) or SS (signal switch). The 7500 Mortise lock is equipped with a 3/4" anti-friction latch bolt which is field reversible without removing the lock from the door. It has a non-handed auxiliary bolt for deadlocking and a faceplate with an adjustable bevel.



9975 & 9975-F (also available Fire-Rated)

## SCREEN DOOR HARDWARE

### SINGLE BORE LOCK

Single bore latch, 1" backset, requires a 15/16" hole. Has inside lock. Fully reversible. Door Thickness: 5/8" to 1-1/8".



Code	Finish	List/ea
1100301	Polished Brass	\$ 51.61
1100211	Venetian Bronze	53.93
1100151	Satin Nickel	47.57

### STORM DOOR LOCK

Tubular latchset fits doors from 7/8" to 1-1/8" thick. Reversible, with inside privacy lock. Backset: 1-3/4". Edgebore: 5/8" .



Code	Finish	List/ea
1159301	Polished Brass	\$ 36.84
1159151	Satin Nickel	41.99

### BELWITH GLASS REPLACEMENT KNOBS

Glass Knob set includes one pair of knobs and a spindle.



Code	Description	Ctn	List/cd
1140	Glass Knob Set	5	\$ 11.27

### SCREEN DOOR MORTISE LOCK & TRIM

Eric Morris - All Special Order

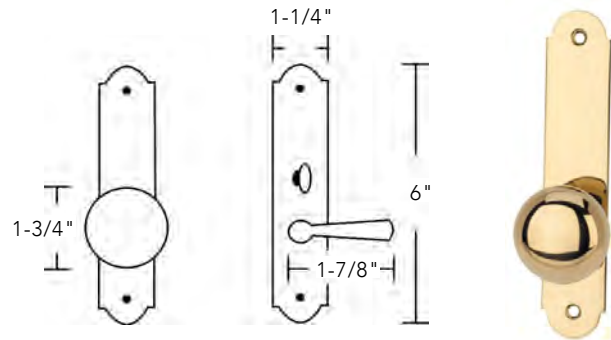

Solid Brass Buckingham Trim. Knob Outside, Lever Inside.

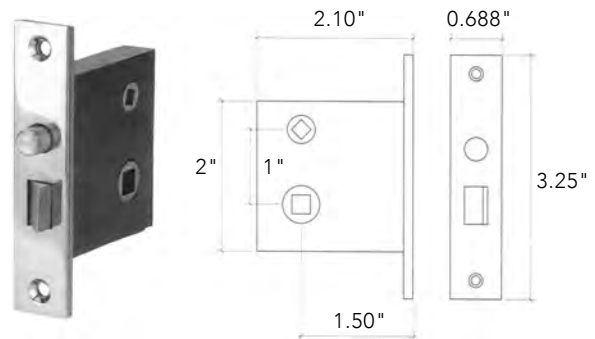

The latch case is precision cast iron. Its small size makes mortising easy and its smooth sides provide easy insertion. Interior working parts are powder forged brass. The brass front is applied over a steel sub face plate. Dual springs of Stainless Steel prevent lever sag. Latch is field reversible. Two way hub rotation allows lock to be installed with the turn piece either above or below the lever. Minimum door thickness is 1-1/8". Use Thick Door Kit for doors over 1-3/8" and up to 1-3/4".

Trim is Solid Brass. Mortise Box is cast iron. Backset: 1-1/2". Straight lip strike.

Complete Lockset	Finish	List
8000/9000-605E	Pol. Brass, Tarn-Free	Call for Pricing
8000/9000-613	Oil R. Bronze	
8000/9000-619	Satin Nickel	
Full Dummy	Finish	
8010FD-605E	Pol. Brass, Tarn-Free	
Thick Door Kit	Finish	
9000TDK	All Std. Finishes Avail.	



## EDGE PULLS

### **BALDWIN** **EDGE PULL**

Solid Forged Brass

3.875" x .75" x 1.625"

Spring loaded, returns lever flush with face plate. Narrow design eliminates installation problems on thin doors. One per box with screws.



Code	Finish	List/ea
0465-003	Lifetime Pol. Brass	\$ 22.02
0465-056	Lifetime Sat. Nickel	22.02
0465-030*	Polished Brass	22.02
0465-260	Bright Chrome	22.02
0465-102	Oil R. Bronze	22.02
0465-264*	Dull Chrome	22.02
0465-050	Sat. Brass & Black	22.02
0465-112	Venetian Bronze	22.02
0465-402	Distr. Oil R. Bronze	22.02

\*disc when out

### **IDH EDGE PULL**

Solid Brass

Polished Solid Brass. Rugged construction. The 3/4" width allows installation on both narrow and standard doors. Spring automatically returns lever flush with plate.

3-7/8" x 3/4" x 1-5/8" with screws.



Pack: 10 each

Code	Finish	List/ea
14020-003	Polished Brass	\$ 16.03
14020-015	Satin Nickel	17.93
14020-026	Polished Chrome	15.96
14020-26D	Dull Chrome	10.36
14020-10B	Oil Rubbed Bronze	18.00

## POCKET DOOR LOCKS

### **IDH POCKET & SLIDING DOOR LOCKS**

Height: 2-3/4", Width: 2-1/2"

**PASSAGE:** Door pull has flush pulls on both sides. Fully adjustable for 1-3/8" to 1-3/4" thick doors. 10 each per box.



Code	Finish	List/ea
25410-003	Polished Brass	\$15.57
25410-005	Antique Brass	15.57
25410-10B	Oil Rubbed Bronze	17.13
25410-026	Polished Chrome	17.13
25410-26D	Dull Chrome	17.13
25410-015	Satin Nickel	17.13
25410-15A	Antique Nickel	16.48

**PRIVACY:** Lock and unlock by thumb turn inside pull. Emergency entry from outside. For 1-3/8" thick doors. 10 each per box.



Code	Finish	List/ea
25411-003	Polished Brass	\$ 18.13
25411-005	Antique Brass	21.30
25411-10B	Oil Rubbed Bronze	21.22
25411-026	Polished Chrome	21.30
25411-26D	Dull Chrome	17.75
25411-015	Satin Nickel	21.22
25411-15A	Antique Nickel	17.71

### **IVES SLIDING DOOR** **PRIVACY BOLT**

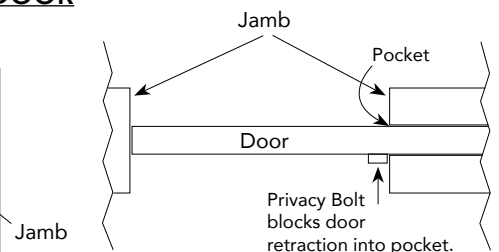

Spring activated design. Mortise depth: 3/8". Emergency release of bolt from outside the door. Solid Brass. Size: 15/32" x 3-1/16" x 5/8", Strike: 1" x 3/4".

Code	Finish	Ctn	List/ea
42B10B	Oil R. Bronze	10 ea.	\$ 14.90
42B15	Satin Nickel	10	17.14
42B26D	Dull Chrome	10	15.15
42B3	Polished Brass	10	15.19

## POCKET DOOR LOCKS

### PRIVACY POCKET DOOR LOCK

For 1-3/8" and 1-3/4" Thick Doors

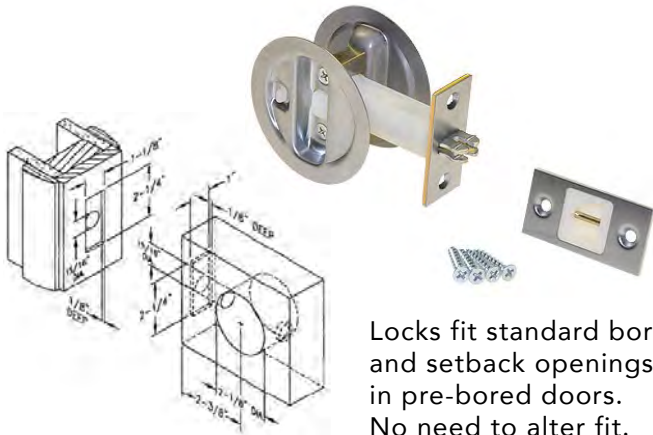

Locks fit standard bore and setback openings in pre-bored doors. No need to alter fit.

Code	Door Thickness	Finish	List/ea
1521-3	1-3/8"	Pol. Brass	\$ 28.20
1521-15	1-3/8"	Sat. Nickel	26.39

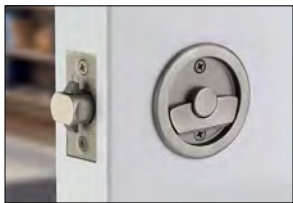

Installed Privacy Lock

**EMTEK**

### POCKET DOOR TUBULAR LOCKS

**Special Order.** For 1-3/8" to 1-3/4" thick doors. 2-3/8" backset only. Dummy includes edge pull.

#### Square Style, 2-1/2" x 2-1/2"



2134

Code	Function	List/ea
2134	Passage	\$ 64
2135	Privacy	99
2136	Dummy - Double Door Application	64

#### Round Style, 2-1/2" dia.



2145

Code	Function	List/ea
2144	Passage	\$ 64
2145	Privacy	99
2146	Dummy - Double Door Application	64

**Available finishes:** Polished Brass (US3), Satin Brass (US4), French Antique (US7), Oil R Bronze (US10B), Polished Nickel (US14), Satin Nickel (US15), Pewter (US151A), Flat Black (US19), Polished Chrome (US26)



**EMTEK**

### POCKET DOOR MORTISE LOCKS

**Special Order.** Handing not required. Minimum door thickness: 1-3/8". Must specify door thickness for ALL functions.



#### Narrow Modern Rectangular 2" x 7-1/4"

Code	Function	Avail Finishes	List/ea
2153	Keyed	Satin Brass (US4) Oil R Brz (US10B)	\$ 313
2154	Passage	Pol. Nickel (US14)	276
2155	Privacy	Satin Nickel (US15) Flat Black (US19)	276
2156	Dummy	Pol. Chrm (US26)	276



#### Modern Rectangular 2-7/8" x 7-1/4"

Code	Function	Avail Finishes	List/ea
2113	Keyed	Pol. Brass (US3)	\$ 313
2114	Passage	Satin Brass (US4) French Ant. (US7)	276
2115	Privacy	Oil R Brz (US10B) Pol. Nickel (US14)	276
2116	Dummy	Satin Nickel (US15) Pewter (US15A) Flat Black (US19) Pol. Chrm (US26)	276



#### Classic 2-1/2" x 7-1/2"

Code	Function	Avail Finishes	List/ea
2103	Keyed	Pol. Brass (US3)	\$ 313
2104	Passage	Oil R Brz (US10B) Satin Nickel (US15)	276
2105	Privacy	Pol. Chrm (US26)	276
2106	Dummy		276



#### Sandcast Bronze Rustic Modern Rectangular 2-1/2" x 8-1/2"

Code	Function	Avail Finishes	List/ea
2123	Keyed	Flat Black Brz (FB)	\$ 430
2124	Passage	Med Brz (MB)	375
2125	Privacy	Tumbled White Brz (TWB)	375
2126	Dummy		375

## POCKET DOOR LOCKS

### ERIC MORRIS MORTISE POCKET DOOR LOCK

Bryn Mawr Design - Special Order



Interior Exterior

Entry - 82193



Interior Exterior

Privacy - 82191

#### Bryn Mawr Pocket Door Lock:

- Rectangular Plate with Recessed Center
- Brass Recessed Pull Ring
- Solid Forged Brass Finger Pull
- Hand Polished
- Complete sets: Passage, Privacy, Bit Key set, Single/ Double Cylinder sets and more

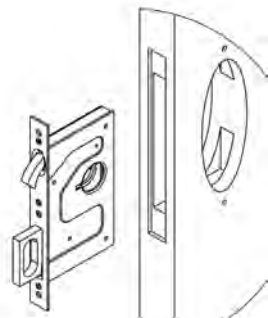

Heavy Duty Steel case has a built-in edge pull.  
 Overall size: 8" x 3-1/2" x 7/8"  
 Recess depth: 0.25"  
 Backset on lock box: 2.5"  
 Case Size: 3.5" x 5.75" x 0.563"  
 For doors 1-3/8" to 3" thick  
 Material gauge: .04"

Each Set includes trim and mortise box. Finishes available as Standard, Distressed, and PVD Brass. See below for some finish examples.

Standard: 605 (Pol. Brass), 613 (Oil R Bronze), 619 (Sat. Nickel), 626 (Sat. Chrome)

Distressed: 609D (Distr. Satin Brass), 613D (Distr. Oil R Bronze)

All Special Order.

Code	Function	(Std) 605, 613 619, 626	(Distr) 609D 613D	PVD Brass 605E
82190	Passage			
82191	Privacy			
82193	Entry			

Call for Pricing

### BALDWIN SLIDING DOOR LOCKS

The Santa Monica style puts a visual emphasis on vertical and horizontal lines, with a focus on pure geometry without sacrificing comfort. Available in both Large and Small varieties in Satin Nickel and Oil Rubbed Bronze. Other finishes available special order.



4

#### PD005-150-PRIV

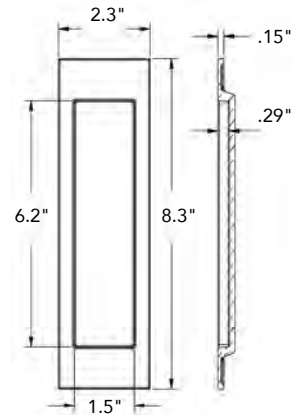

Min. Door Thickness: 1-3/4"

#### PD006-102-PRIV

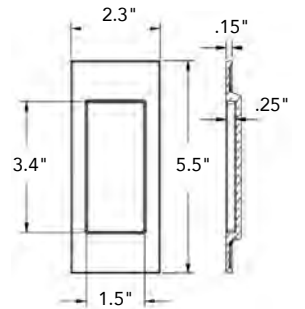

Min. Door Thickness: 1-3/8"

Code	Description	Finishes	List/ea
PD005-XXX-PASS	Passage set w/ 2.5" backset lock	102, 150	\$ 724.64
PD005-XXX-PRIV	Privacy set w/ 2.5" backset lock	102, 150	814.72
PD005-XXX-IPS	Passage Trim-Half pair	102, 150	146.13
PD006-XXX-PASS	Passage set w/ 2.5" backset lock	102, 150	668.59
PD006-XXX-PRIV	Privacy set w/ 2.5" backset lock	102, 150	760.68
PD006-XXX-IPS	Passage Trim-Half pair	102, 150	118.11

102 - Oil R Bronze, 150 - Satin Nickel

## FINGER & FLUSH PULLS

### IDH FLUSH SLIDING DOOR PULL



25420-005

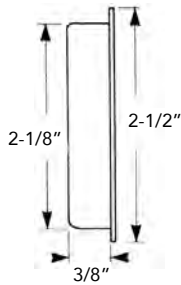

Wrought Brass.  
 Hand polished.  
 Overall Diameter: 2-1/2"  
 Built-in prongs  
 eliminate need for  
 screws.

Pack: 10 each.

Code	Finish	List/ea
25420-003	Polished Brass	\$ 7.28
25420-005	Antique Brass	3.38
25420-015	Satin Nickel	7.64
25420-026	Polished Chrome	7.64
25420-26D	Dull Chrome	5.70
25420-10B	Oil Rubbed Bronze	5.70

### KV FLUSH FINGER PULLS

Overall Diameter: 31/32",  
 Bore: 25/36", Depth: 1/4"



801X

Code	Finish	Ctn	List/ea
801X	Brass	100	\$ 1.98
801XNP	Nickel	100	2.14

### EMTEK FLUSH PULLS

Solid Brass

**Special Order.** Square and Round fit std. 2-1/8" door prep.



Code	Description	List/ea
2213	Square, 2-1/2" x 2-1/2"	\$ 22



2211	Round, 2-1/2" dia.	22
------	--------------------	----



2201	Rectangular, 1-3/4" x 4"	22
------	-----------------------------	----

**Available finishes:** Pol. Brass (US3), Satin Brass (US4),  
 French Ant. (US7), Oil R Brz (US10B), Pol. Nickel (US14),  
 Satin Nickel (US15), Pewter (US151A), Flat Black (US19),  
 Pol. Chm (US26), Med Brz (MB), Tumbled Wht Brz (TWB)

### IDH RECTANGULAR FLUSH PULL

- Premium Quality Forged Solid Brass
- Shallow depth / Low profile
- Ideal for louvered, bifold or closet doors

Length: 3-1/8", Width: 1-5/16",  
 Depth: 5/16", Overall Depth: 3/8"

Pack: 10 each with screws

Code	Finish	List/ea
25400-003	Polished Brass	\$ 15.19
25400-005	Antique Brass	16.19
25400-015	Satin Nickel	16.19
25400-026	Polished Chrome	16.19
25400-10B	Oil Rubbed Bronze	16.19
25400-15A	Antique Nickel	14.71
25400-26D	Dull Chrome	14.71



25400-015

### BALDWIN FLUSH PULL

Solid Forged Brass

1-1/2" x 3-1/2" x 3/8" Deep.

Clearance required is .187" projection  
 from mounting surface. Thickness of  
 flange is .187". Decorative flush sliding  
 door pull may be used as a sash lift.

Colonial design makes it suitable for  
 Early American interiors. Extra heavy  
 solid brass construction.  
 Screws included. 1 ea/box.

Code	Finish	List/ea
0458-030*	Pol. Brass	\$ 33.03
0458-102	Oil R. Bronze	33.03
0458-150	Satin Nickel	33.03
0458-112	Venetian Bronze	33.03

\*disc when out



0458-102



## FINGER & FLUSH PULLS

### IVES FLUSH PULLS

227 - Wrought Brass

Contoured for ease of pulling. Extra deep well.

3-5/8" x 1-3/4" x 9/16".  
With screws.



227B

Code	Finish	Ctn	List/ea
227B15	Satin Nickel	10	\$ 14.86
227B10B	Oil R. Bronze	10	14.40

### KV BRASS FLUSH DRAWER PULL

Beveled edge brass flush drawer pull. 12/box with screws. 1-3/4" x 3-1/4" x 9/16" deep, with beveled edges.



819X

Code	Finish	Ctn	List/ea
819XPB	Pol. Brass	12 ea.	\$ 28.96
819XANO	Anochrome	12	15.95

### KV THREADED FINGER PULL

Two-piece screw-together pull for glass 3/16" to 15/16" thick. 1-1/16" OD rim. Drill 13/16" hole in glass. Anochrome finish.



836A

Code	Ctn	List/ea
836A	50 ea.	\$ 4.89

### BAINBRIDGE RECESSED PULL



1710-20BL

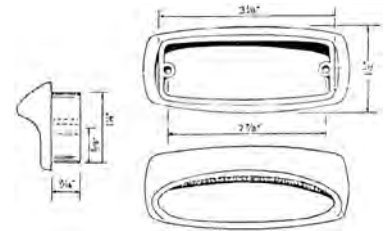

Recessed pull for all applications including lids, drawers, and doors. Plastic.

Size: 3-1/8" x 1-1/2" x 7/16" projection from mounting surface. With screws.

Code	Finish	Ctn	List/ea
1710-20BL	Black	100 ea.	\$ 2.59

### FLUSH MOUNT PLASTIC HANDLES

black almond



2867

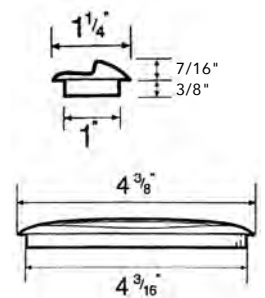

Screw C to C: 3-3/4"  
260 per ctn.

Code	Finish	List/ea
2867-014	Black	\$ 2.12
2867-029*	Almond	2.27

\*disc when out



## FLUSH PULLS

### BALDWIN FLUSH RING PULLS

Solid Brass



**No. 0392**

1.25" W x 1.5" H x  
5/8" ID Flat Top Ring

<u>Code</u>	<u>Finish</u>	<u>List/ea</u>
0392-003	Lifetime Polished Brass	\$ 35.03
0392-056	Lifetime Satin Nickel	35.03
0392-102	Oil R. Bronze	35.03



**No. 0393**

1.625" W x 1.625" H x  
5/8" Ring ID

<u>Code</u>	<u>Finish</u>	<u>List/ea</u>
0393-003	Lifetime Polished Brass	\$ 36.03
0393-056	Lifetime Satin Nickel	36.03
0393-102	Oil R. Bronze	36.03
0393-260	Polished Chrome	36.03



**No. 0394**

1.875" W x 2.5" H x  
1" Ring ID

<u>Code</u>	<u>Finish</u>	<u>List/ea</u>
0394-003	Lifetime Polished Brass	\$ 45.04
0394-056	Lifetime Satin Nickel	45.04
0394-102	Oil R. Bronze	45.04
0394-260	Polished Chrome	45.04



**No. 0395**

2.5" W x 3.3" H x  
1-1/2" Ring ID

<u>Code</u>	<u>Finish</u>	<u>List/ea</u>
0395-003	Lifetime Polished Brass	\$ 58.05
0395-056	Lifetime Satin Nickel	58.05
0395-102	Oil R. Bronze	58.05
0395-260	Polished Chrome	58.05

### DELTANA FLUSH RING PULLS

Solid Brass



**FRP175**

1-3/8" W x 1-3/4" H"



**FRP25**

1-7/8" W x 2-1/2" H

<u>Code</u>	<u>Finish</u>	<u>Ctn</u>	<u>List/ea</u>
FRP175U3	Polished Brass	50 ea.	\$ 12.10
FRP175U15	Satin Nickel	50	16.33
FRP175U10B	Oil R Bronze	50	16.20
FRP25U3	Polished Brass	20	20.88
FRP25U15	Satin Nickel	20	26.54
FRP25U10B	Oil R Bronze	20	26.54





## TYDIX FLUSH PULLS

### TYDIX FLUSH PULLS

All Special Order

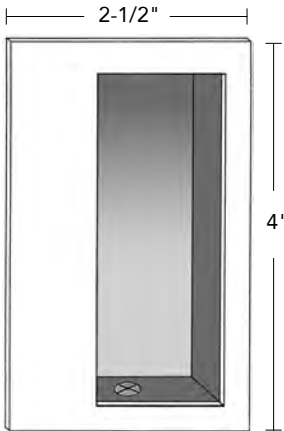

No. 61064 4" x 2-1/2"

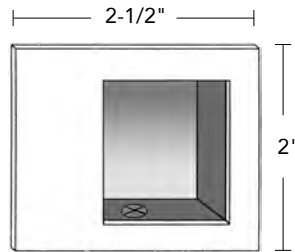

No. 61063 2" x 2-1/2"

### SINGLE PULL FOR DOORS & DRAWERS



### TWO PULLS -- ONE DOOR

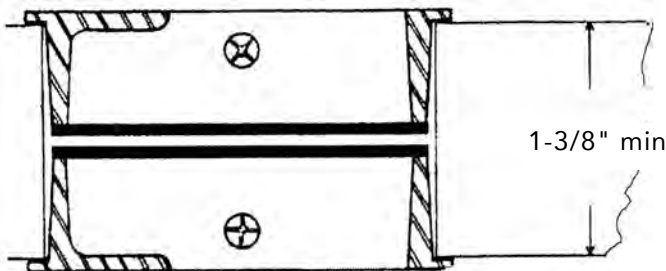

### TYDIX FLUSH PULLS

All Special Order

#### TO ORDER, SPECIFY THE FOLLOWING:

1. Flush Pull Number
2. Finish of Face
3. Color Inside (Black is standard)
4. Backplate Color (Black is standard)

#### TAMPERPROOF SCREWS:

Specify "TMP" and add \$ 1.32 list

#### TYDIX FLUSH PULL PRICING

(Other Finishes are Available - Call for Price)

Code	Face Finish	Inside Finish	List/ea
61063 US3XBLK	Pol. Brass	Black	\$ 159
61063 US26XBLK	Pol. Chrome	Black	138
61063 US26DXBLK	Dull Chrome	Black	138
61063 US10BXBLK	Oil R. Bronze	Black	138
61064 US3XBLK	Pol. Brass	Black	174
61064 US26XBLK	Pol. Chrome	Black	168
61064 US26DXBLK	Dull Chrome	Black	168
61064 US10BXBLK	Oil R. Bronze	Black	168

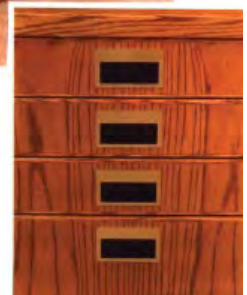

4

# BY-PASS DOOR HARDWARE

# HETTICH

**Hettich** GRANT 6034 SERIES BY-PASSING DOOR TRACK - 50/75 LBS.

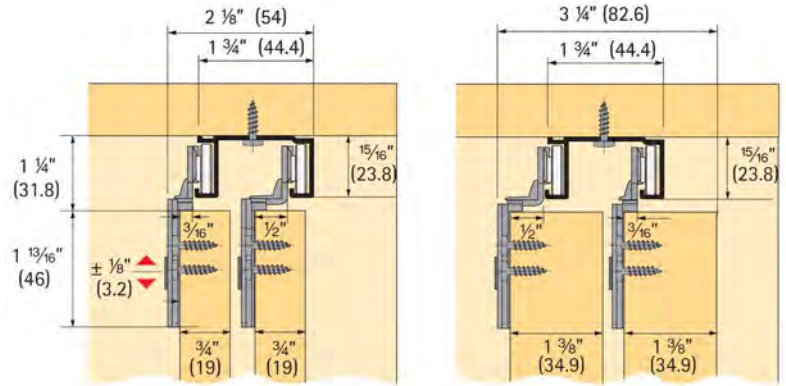
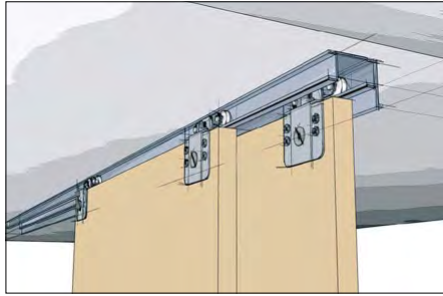

For Two 3/4" or 1-3/8" Doors

- Hangers can be reversed to fit either size door
- Adjusts 1/4" vertically, Headroom 1-1/8" - 1-3/8"
- For 3/4" and 1-3/8" Doors weighing up to 50 lbs/door with 6034 hdwr set, 75 lbs/door with 6064 hdwr set
- Ball-bearing wheels ensures a smooth, quiet and long lasting performance

- Dual set of mounting holes; ideal for hollow core doors
- Dust free track design
- Quick door hanging by tilting pre-mounted hardware onto track profile
- Floor guide required

**Must order Track and Hardware separately**

**ALUMINUM DOUBLE TRACK**

For Two 3/4" or 1-3/8" Doors

Extruded aluminum track for by-passing doors.

1-3/4" wide, 15/16" high.



Code	Size	Ctn	List/ea
6004-4	4'	5 ea.	\$ 45.92
6004-6	6'	5	50.83
6004-8	8'	5	48.68
6004-12	12'	5	90.99
6004-16	16'	5	97.09

**HARDWARE SETS**

6034 (50 lb.) Hardware set includes:

- (2) 6320 single wheel 3/16" offset carriers
- (2) 6330 single wheel 1/2" offset carriers
- (1) 114 Nylon double floor guide & screws/instructions



6064 (75 lb.) Hardware set includes:

- (2) 6350 double wheel 3/16" offset carriers
- (2) 6360 double wheel 1/2" offset carriers
- (1) 114 Nylon double floor guide & screws/instructions



Code	Description	Ctn	List/set
6034	50 lb. Hardware Set	10 sts.	\$ 36.26
6064	75 lb. Hardware Set	10	59.65

**CARRIERS ONLY**

As used in 6034/6064 hardware sets



Code	Description	Ctn	List/ea
6320	Carrier w/ 3/16" offset	50 ea.	\$ 6.75
6330	Carrier w/ 1/2" offset	50	5.75
6350	Double Wheel Carrier w/ 3/16" offset	50	13.59
6360GR	Double Wheel Carrier w/ 1/2" offset	50	12.65

**FLOOR GUIDE**

Fits into slot cut into bottom of sliding doors. Hidden from view. Zinc plated zamak.



Code	Description	Ctn	List/ea
7015	Floor Guide w/slot	50 ea.	\$ 10.03

## BY-PASS DOOR HARDWARE



### GRANT 7000 SERIES SLIDING DOOR HARDWARE

By-passing sets for doors up to 150 lbs. each.

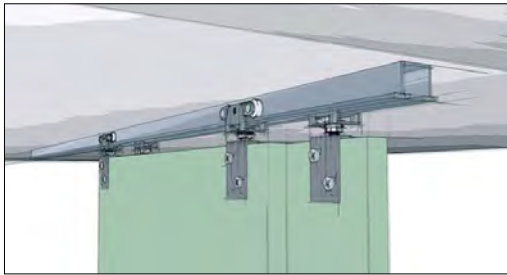

- For 1-3/8" and 1-3/4" doors up to 150 lbs.
- Steel, precision ball-bearing wheels
- Aluminum Double "I" Beam track, jump proof
- Serrations in carrier aprons permit vertical adj.
- Headroom: 1-7/8" min, 2-1/8" max
- Floor guide nylon on steel

For Doors 1-3/8"

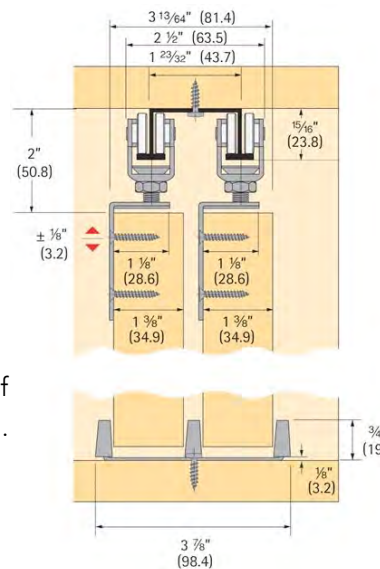

For Doors 1-3/4"

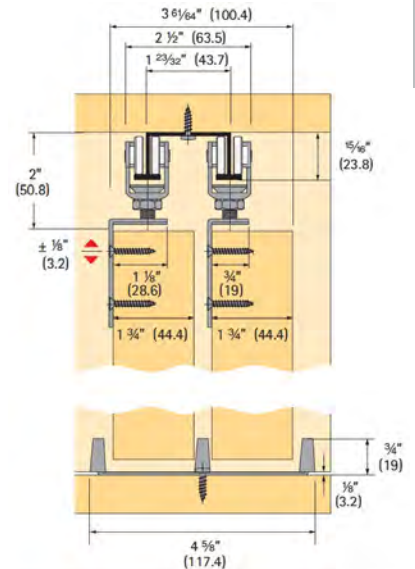

**Must order Track and Hardware separately**

#### DOUBLE TRACK 7003

Aluminum Extruded, pre-drilled holes

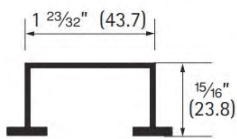

#### 72-138 HARDWARE SET for 1-3/8" Doors

Set includes: (4) 7000 door carriers, (4) 7138 aprons, (1) 117 floor guide, screws, wrench and instructions



**7000** Ball-bearing carrier, up to 150 lbs/door



**7138** Apron 1-1/8" Offset



**117** Floor guide

Code	Description	Ctn	List
7003-8	8' Track	10	\$ 99.75 /ea
72-138	Hardware set for 1-3/8" Doors	20 sts	193.10 /st
72-134	Hardware set for 1-3/4" Doors	20	193.87

#### 72-134 HARDWARE SET for 1-3/4" Doors

Set includes: (4) 7000 door carriers, (2) 7034 aprons (front door), (2) 7138 aprons (rear door), (1) 118 floor guide, screws, wrench and instructions



**7000** Ball-bearing carrier, up to 150 lbs/door



**7034** Apron 3/4" Offset



**7138** Apron 1-1/8" Offset



**118** Floor guide



## BY-PASS DOOR HARDWARE

## ACME SYSTEMS BY RENIN

### BY-PASSING DOOR HARDWARE

For Two 1-3/8" Doors, 60 lbs. each

1 piece single wheel door hangers for light weight or hollow core doors. Each set contains: track, hanger, guides, and pulls. Galvanized steel double "J" tracks can be cut to size.

4

For two 1-3/8" doors up to 60 lbs. each.  
10 sets per carton.



**40-3006**  
46-1/2 Wide  
For Two 2' Doors  
List \$ 30.15 set

**40-3008**  
58-1/2 Wide  
For Two 2'6" Doors  
List \$ 32.20 set

**40-3010**  
70-1/2 Wide  
For Two 3' Doors  
List \$ 39.16 set

#### EASY ADJUSTMENT

Simply insert screwdriver in hanger slot and turn to adjust for plumb. Doors hold position when screws are loose to eliminate shiming.



#### Steel Track

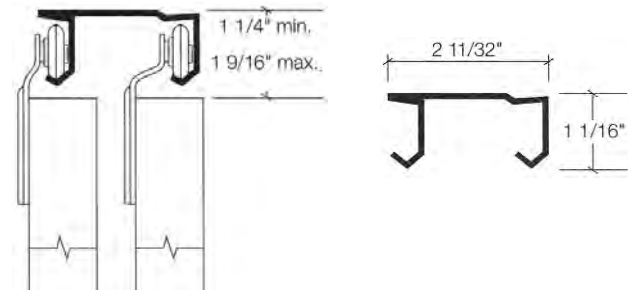

### REPLACEMENT HANGERS



Code	Finish	Size	Ctn	List/pr
54-1268	Alum.	1/4" Offset	50 pr.	\$ 2.60
54-1284	Alum.	1/2" Offset	50	3.84

### BY-PASSING DOOR HARDWARE

For Two 3/4" or 1-3/8" Doors, 60 lbs. each

For two 3/4" or 1-3/8" by-passing doors weighing up to 60 lbs. each.

Set contains:  
1 aluminum track,  
1 pr. 8901 hangers and  
1 pr. 8902 hangers, 1 floor  
guide, 2 pulls, screws and  
instructions.



10 sets per package.

Code	Description	List/st
40-3020	Set for two 2' Doors	\$ 57.82
40-3022	Set for two 3' Doors	69.48

Cross Reference - see chart page 422  
Johnson 1166

## ACME SYSTEMS BY RENIN

## BY-PASS DOOR HARDWARE

### HEAVY DUTY BY-PASSING DOOR HARDWARE

For installation of 2 by-passing doors, with 1-3/8" to 1-3/4" thick panels. 150 lb. and 250 lb. capacities available.

#### ALUMINUM SINGLE TRACK

Use 2 tracks per by-passing set. 5', 6', 8', 10', 12' and 16' lengths available. Order hardware sets separately. 1 per Ctn.



#### DOOR CARRIER SETS - 150 lb or 250 lb

##### For 150 lb set:

- 2 each Tracks
- 1 set 40-5860 Hardware Set



40-5860 Hardware set includes : 4 ea. 4-wheel carriers, door plates, floor guide, wrench, and screws.

##### For 250 lb set:

- 2 each Tracks
- 2 sets 64690 Hangers
- 1 ea. 40-3534 Floor Guide



40-3534 Adj. Floor Guide  
 1-3/8" to 1-3/4"

Track	Length	List/ea
40-5103	60" Track	\$ 43.80
40-5104	72" Track	54.54
40-5105	96" Track	88.68
40-5106	120" Track	103.11
40-5107	144" Track	147.64
40-5108	192" Track	135.00

150 lb. Hardware Set	Ctn	List
40-5860	10 sets	\$ 53.73 /st

250 lb. Hardware	Ctn	List
64690 Top Hangers	1 pr	\$ 36.29 /st
40-3534 Floor Guide	10 ea	10.68 /ea

### Features

- Large 1" wheels provide smooth rolling action
- Easy-to-install snap-in feature makes hangers a "snap" to install
- Vertical adjustments can be made after installation
- Supports panels weighing up to 150 or 250 lbs
- Durable V-groove aluminum track provides smooth, quiet operation
- Track spacer allows for easy installation of bi-pass and tri-pass doors

#### INSTALLATION DETAIL

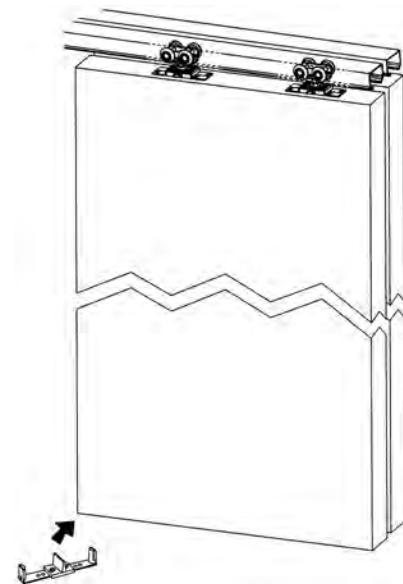

#### 1 3/4" Doors

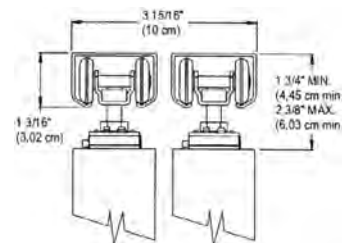

#### 1 3/8" Doors

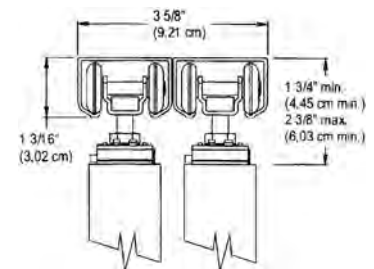

NOTE: Door height should be 2-5/8" less than finished opening height

#### Cross Reference - see chart page 422

- Grant 7000 • Johnson 100SD • Cox 15
- Crowder C-500 • Hager 9875

## DOOR PARTS

### No. 40-5304 Wheel Carrier

150 lbs.

Can be used for By-pass, Pocket door, or panel pocket frame sets.



### No. 63530 Hanger & Pivot Set

250 lbs, Heavy Duty

Includes 4 wheel hanger, top and bottom pivots, wrench, screws and instructions. Bottom pivot has ball-bearing raceway. Fits into 1-3/4" deep, 3/8" diameter hole in door.



63530



40-3993



40-3997

### No. 40-3993 Pocket Door Guide:

Adjusts to center door in pocket for 1-3/8" door.

### No. 40-3997 Pocket Door Guide:

Adjusts to center door in pocket for 1-3/4" door.



54-1008



54-1016

### No. 54-1008 Floor Guide:

Adjustable for 3/4" to 1-3/8" thick by-passing doors.

### No. 54-1016 Carpet Riser:

For mounting 54-1008 guide over carpeted floor. 1/2 Rise.

## ACME SYSTEMS BY RENIN

### Stanley Equal

### No. 52-2612 Top Pivot:

Spring-loaded, mounts in pivot and guide doors



52-2612

### No. 52-2620 Top Guide Wheel:

Spring-loaded and self-adjusting, mounts in guide doors.



52-2620

### No. 40-0004 Center Stop:

Attaches to track to limit panel travel. 1-5/8" L x 1-3/16" W



### No. 52-2232 Adjusting Wrench:



### No. 52-2236 Top Pivot Bracket:



### No. 40-2309 Guide Roller:

Adjustable high performance lubricated thermoplastic guide. 7/16 dia. shank



40-2309

### PARTS PRICE LIST

Code	Description	Ctn	List
40-0004	Center Stop	20 ea	\$ 6.91
40-2309	Guide Roller	10 ea	5.41
40-3993	P Door Guide, 1-3/8"	50 ea	4.68
40-3997	P Door Guide, 1-3/4"	50 ea	10.34
63530	250 lb. 4-wheel Hanger & Pivot set	1 bg	61.44
40-5304	150 lb. wheel carrier	20 pr	20.95
52-2232	Adjusting wrench	400 ea	1.26
52-2236	Top Pivot Bracket	200 ea	.70
52-2612	Top Pivot	200 ea	.51
52-2620	Top Guide Wheel	200 ea	.73
54-1008	Floor Guide	50 ea	2.85
54-1016	Carpet Riser	50 ea	2.34

## SLIDING DOOR HARDWARE



## BI-FOLD DOOR HARDWARE

### HETTICH/GRANT 1200 SLIDING DOOR HARDWARE

1210 for Doors up to 225 lbs.

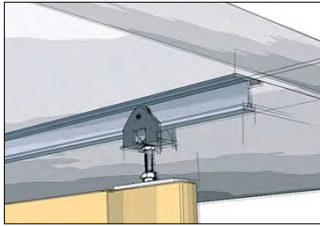

1230 for Doors up to 325 lbs.

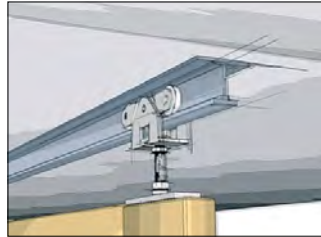

- For doors 1" and up.  
 225 lbs /door with 1210 hardware set,  
 325 lbs /door with 1230 hardware set
- Large nylon ball-bearing wheels, 1/2" vert. adjustment
- Extruded aluminum "I" beam track; jump proof design

#### 1210 Hdwr set includes:

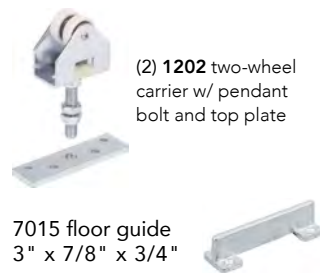

(2) **1202** two-wheel carrier w/ pendant bolt and top plate

7015 floor guide  
 3" x 7/8" x 3/4"

#### 1230 Hdwr set includes:

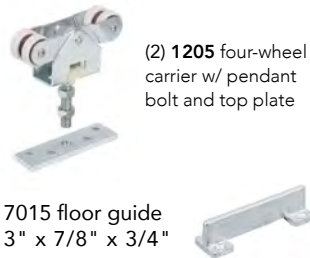

(2) **1205** four-wheel carrier w/ pendant bolt and top plate

7015 floor guide  
 3" x 7/8" x 3/4"

#### Accessories



**1212** Stop  
 - For use with 1210 Hardware Set



**1213** Stop  
 - For use with 1230 Hardware Set

#### TRACK ONLY

Aluminum extruded "I" Beam Track



Code	Description	Ctn	List
1201-8	8' Track	5 ea.	\$ 76.06/ea
1201-12	12' Track	5	122.09

#### HARDWARE SET / ACCESSORIES

1210	225 lb. Hardware set	10 sts.	\$ 120.83/st
1230	325 lb. Hardware set	10	142.95
1205	Four wheel carrier	10 ea.	46.01/ea
7015	Floor guide	10	10.03
1212	Stop - use with 1210 set	10	19.52
1213	Stop - use with 1230 set	5	39.35

### HETTICH/GRANT 1260 BI-FOLD DOOR SET

Up to 175 lbs/ door

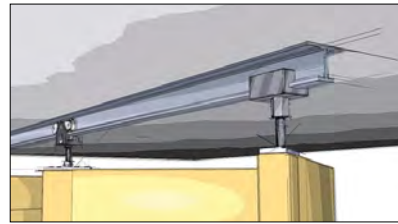

Track and hardware sold separately, one each required for assembly. Hinges not included. Accessories available.

- For door panels 1" minimum and up
- Extruded pre-drilled aluminum track
- 4 wheel carrier with nylon ball-bearing wheels
- Floor guide channel and door guide available



#### 1260 Hardware set includes:

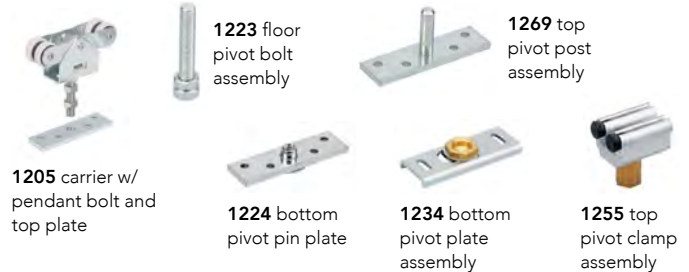

#### Accessories



#### TRACK ONLY

Aluminum extruded "I" Beam Track



Code	Description	Ctn	List
1201-8	8' Track	5 ea.	\$ 76.06 /ea
1201-12	12' Track	5	122.09

#### HARDWARE SET / ACCESSORIES

1260	Hardware Set	5 sets	\$ 121.50 /st
1205	Carrier (extra)	10 ea.	46.01 /ea
1222-8	8' Guide Channel	5	46.20
1222-10	10' " "	5	57.37
1222-12	12' " "	5	58.42
1211	Guide Roller	20	6.47
1221	Door Guide	20	20.52

## BI-FOLD DOOR HARDWARE

## ACME SYSTEMS BY RENIN

### CUSTOM FOLD-A-SIDE AND ACCORDIAN DOOR HDW - 50 lb.

For 1" to 1-3/8" Folding Doors up to 50 lbs. ea. (max. two doors to a jamb)

For 1" to 1-3/8" Accordion Doors up to 30 lbs. ea. (more than two doors to a jamb)

4

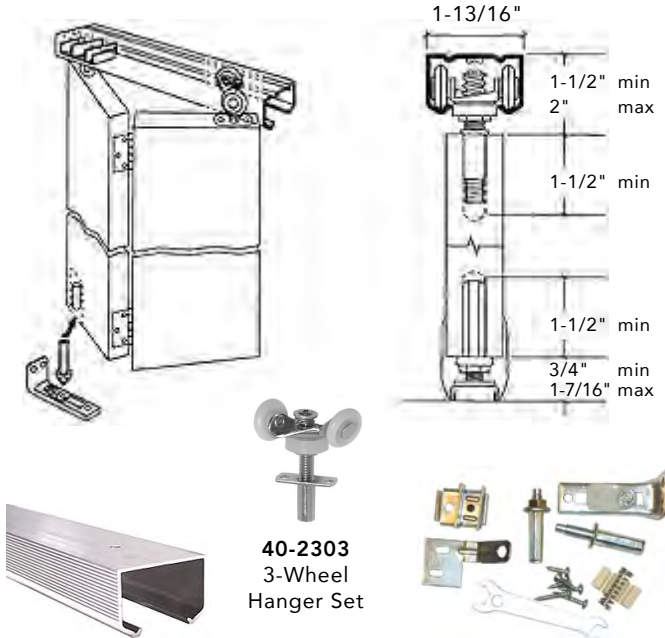

**Jump Proof Aluminum Track:**  
 Track has slots at four foot intervals for inserting hangers without having to cut track short of opening

**40-2308 Pivot Set:**  
 Includes top pivot bracket, jamb bracket, top pivot, bottom pivot, snugger, wrench, screws and instructions

Pack: 10 ea.

Code	Description	List/ea
40-2321	4' track	\$ 33.88
40-2322	5' track	44.59
40-2323	6' track	56.07
40-2324	8' track	62.33
40-2326	10' track	105.79
40-2308	Pivot Set	12.61
40-2303	Hanger	16.13

### Ordering Guide

● Pivot Hardware  
 ○ Hangers

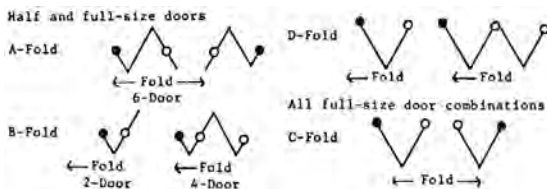

### BI-FOLD DOOR PARTS



### PARTS FOR THE BI-FOLD 30 LB SERIES

Code	Description	Ctn	List
52-2224	Surface Aligner	100	\$ .89
52-2252	Jamb Mtg. Bracket, Alum	200	1.49
52-2272	Top Pivot, 7/16" Hole	200	.76
52-2276	Bottom Pivot, 7/16" Hole	200	1.24
52-2280	Top Guide Wheel 7/16" Hole	200	1.39
52-2372	Slide Guide	200	.73
52-4200	Jamb Mtg. Bracket	200	.73

### PARTS FOR THE BI-FOLD 50 LB SERIES

52-2252	Jamb Mtg. Bracket	200	\$ 1.49
52-2272	Top Pivot, 7-16" hole	200	.76
52-2276	Bottom Pivot, 7/16" Hole	200	1.24

### BI-FOLD DOOR PARTS

Hettich

### GUIDE ROLLER



Steel plate, 3/4" x 2".  
 Fasten to door bottom.  
 1/2" dia. roller rides in guide channel.  
 Use with # 1222 Channel

Code	Ctn	List/ea
1211	20 ea.	\$ 6.47

### ALUMINUM GUIDE CHANNEL



Can be surface mounted or mortised into floor.  
 3/4" x 5/8" high, 3/32" thick.

Code	Ctn	List/ea
1222-8	5 ea.	\$ 46.20
1222-10	5	57.37
1222-12	5	58.42



## ACME SYSTEMS BY RENIN

### HEAVY DUTY BI-FOLD DOOR HARDWARE

Load Cap: 250 lb. per panel



**Order:**

- 1 ea. Track
- 1 ea. 63530 4-wheel hanger & pivot set

For installation of 2 panels weighing up to 250 lbs. each or multi-panels weighing up to 75 lbs. each, 1-1/8" to 1-3/4" thick.

**Aluminum Single Track:**

5', 6', 8, 10', 12', 16'



**No. 63530 Hanger & Pivot Set**

250 lbs, Heavy Duty

63530

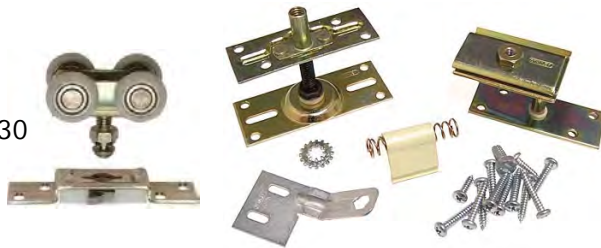

Code	Description	List
40-5103	60" Track	\$ 43.80
40-5104	72" Track	54.54
40-5105	96" Track	88.68
40-5106	120" Track	103.11
40-5107	144" Track	147.64
40-5108	192" Track	135.00
63530	Bi-Fold Hanger set	\$ 61.44

NOTE: Door height should be 2-3/4" less than the opening height.

## BI-FOLD DOOR HARDWARE

**Features:**

- Large wheels provide smooth action
- Easy-to-install snap-in feature makes hangers a "snap" to install
- Durable V-groove aluminum track provides smooth, quiet operation
- All metal components zinc plate to guard against corrosion
- Heavy Duty pivot set designed for durability and aesthetics

4

**INSTALLATION DETAIL**

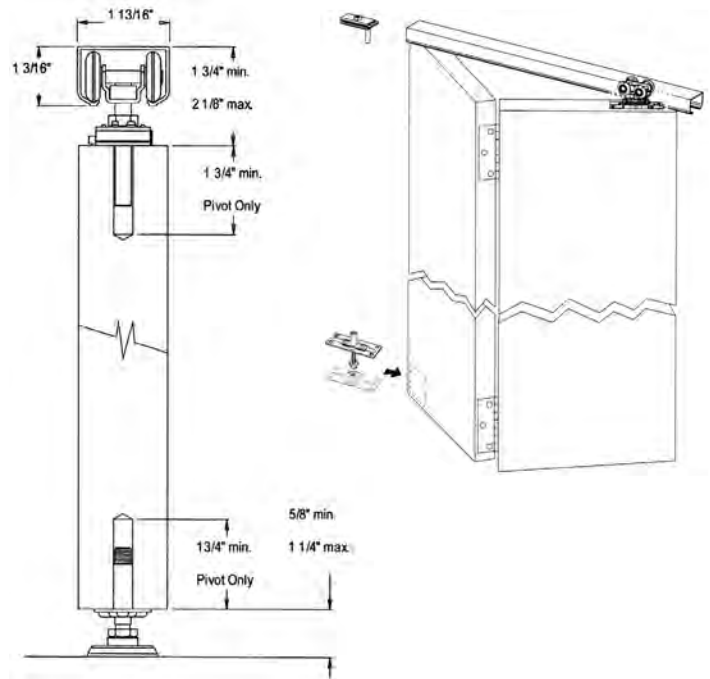

**NON-MORTISE HINGE  
 FOR BI-FOLD DOORS**

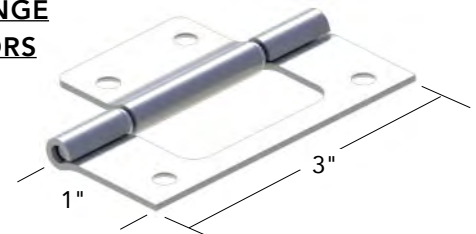

Non-mortise Hinge, Steel w/ bright zinc finish, packed w/ screws.

Code	Ctn	List/ea
9220	100 ea	\$ 3.82

## POCKET DOOR HARDWARE

**Hettich** **GRANT SINGLE DOOR/  
 POCKET DOOR TRACK & HARDWARE**  
 Hardware for Doors up to 150 lbs.

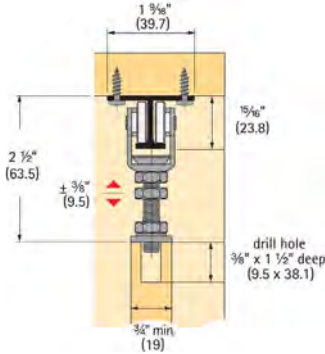
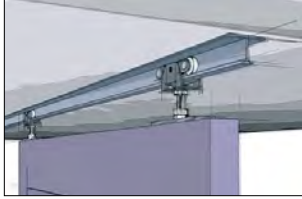

Adjustable top mount for door thickness of 3/4" and up. Order track and hardware separately.

- Top mounting with 3/4" vertical adjustment
- Headroom: 2-1/8" min, 2-7/8" max
- Extruded aluminum "1" beam track, jump proof design
- Precision ball-bearing rollers, nylon floor guide

**7001** Extruded Aluminum Track

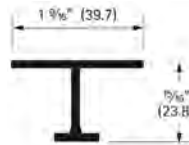
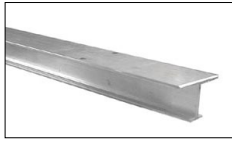

**71-222** Hardware set includes: Two carriers with ball bearing wheels, two top plates with adjustable pendant bolts, one pair of floor guides, one wrench, necessary screws and installation instructions.

### Accessories



**7000** Nylon carrier, steel, up to 100 lbs/door (not included in set)



**7222** Top Plate w/ pendant bolt, adjustable



**7000-15** Ball-bearing carrier, up to 150 lbs/door



**50101** Nylon floor guide (pr)

Code	Description	Ctn	List
7001-6	6' Track	5	\$ 57.82/ea
7001-8	8' Track	5	84.81
71-222	Hardware Set	10	126.81/st
7000-100	Carrier, 100 lbs.	100	\$ 13.09/ea
7000-150	Carrier, 150 lbs.	100	31.57
7222	Top Plate	50	10.88
50101	Floor Guide	50	3.48/pr

## ACME SYSTEMS BY RENIN

### POCKET DOOR TRACK & HARDWARE

Load Cap: 150 lb. per panel

150 lb Capacity for 1" to 1- 3/4" Doors.

**For each Pocket Door order:**

- 1 ea. Track
- 1 ea. 40-5845 Hardware Set

**Features:**

- Four Large 1" wheels for easy rolling action
- Easy-to-install feature makes installation a "snap"
- Easy adjustment after installation
- Cut marks on header make for easy sizing
- V-groove jump proof track



**Aluminum Single Track**

- Deep V-groove twin channel is jump proof
- 5', 6', 8', 10', 12', 16' lengths
- 1-3/16" H x 1-13/16" W



**Hardware Set 40-5845**

Consists of two 4-wheel hangers, 1 door guide, and 1 wrench.

Order Track and Hardware Set Separately.

Track	Length	List/ea
40-5103	60"	\$ 43.80
40-5104	72"	54.54
40-5105	96"	88.68
40-5106	120"	103.11
40-5107	144"	147.64
40-5108	192"	135.00

Hardware Set	Ctn	List/st
40-5845	10 sts.	\$ 29.44

## POCKET DOOR HARDWARE

**INSTALLATION DETAIL**

For installation of pocket or bi-parting doors, with 1" to 1-3/4" thick panels weighing up to 150 lbs. each.

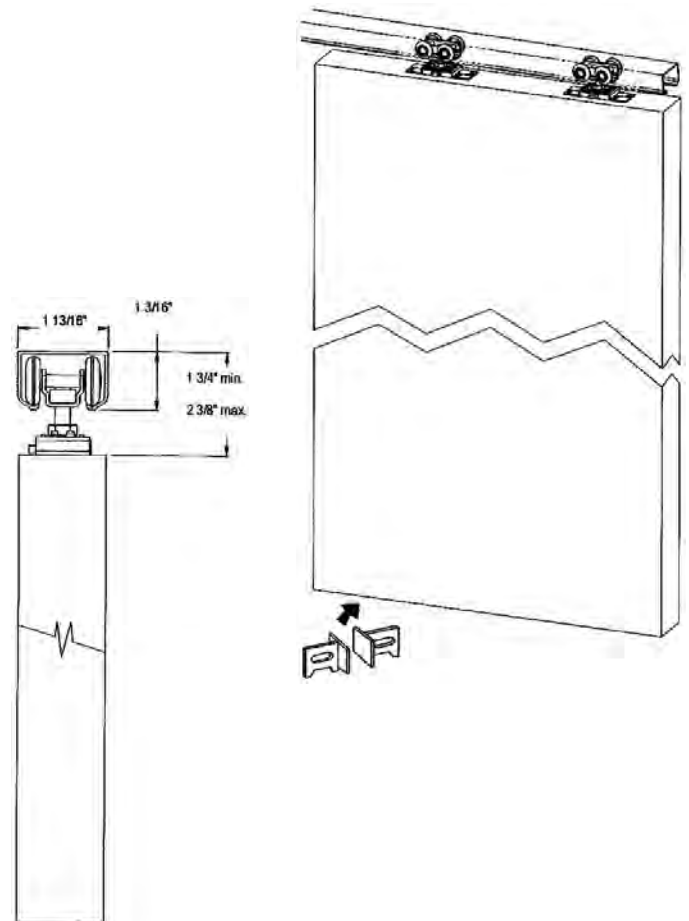

4

**Cross Reference**

Stanley 1750 • Cox 15-200 • Grant 7000 series  
 Hager 9601/9701 • Johnson 100/111  
 Lawrence 506/580 track

## POCKET DOOR HARDWARE

## ACME SYSTEMS BY RENIN

### HEAVY DUTY POCKET DOOR TRACK & HARDWARE

Load Cap: 250 lb. per panel

250 lb. Capacity for 1-1/8" to 1-3/4" Doors.

For use on unusually heavy doors and in institutional installations where the very finest operation is desired. Ideal for moving space dividers, panels and multiple doors. For doors 1-1/8" thick or more.

4

#### For each Pocket Door order:

- 1 ea. Track
- 1 pr. 64690 Hangers
- 1 ea. Door Guide:  
 40-3993 for 1-3/8"  
 40-3997 for 1-3/4"



#### Aluminum Single Track

- Deep V-groove twin channel is jump proof
- 5', 6', 8', 10', 12', 16' lengths
- 1-3/16" H x 1-13/16" W



#### Top Mounting Hangers

64690 - 1 pair (2 each)  
 4 wheel hangers



#### Door Guide

40-3993 for 1-3/8"  
 40-3997 for 1-3/4"

Order Track and Hardware Set Separately.

Track	Length	List/ea
40-5103	60"	\$ 43.80
40-5104	72"	54.54
40-5105	96"	88.68
40-5106	120"	103.11
40-5107	144"	147.64
40-5108	192"	135.00

Hardware	Description	Ctn	List
64690	Top Mounting Hangers	1 st	\$ 36.29/st
40-3993	Door Guide, 1-3/8"	50 ea	4.68/ea
40-3997	Door Guide, 1-3/4"	50 ea	10.34

NOTE: Door height should be 2-5/8" less than the finished opening.

#### Features:

- Four large 1" wheels for easy rolling action
- Easy-to-install feature makes installation a snap
- Supports panels weighing up to 250 pounds
- Easy adjustment after installation
- Cut marks on header make for easy sizing
- V-groove jump proof track

#### INSTALLATION DETAIL

For installation of pocket or bi-parting doors up to 4' wide, weighing up to 250 lbs. each and up to 8' high.

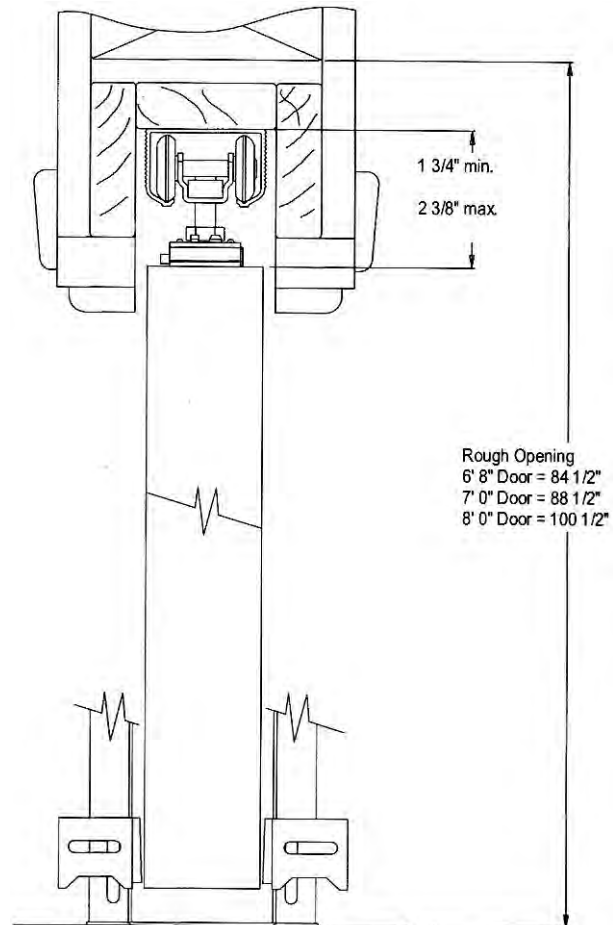

#### Cross Reference

- Stanley 735/40-3925R/40-3940
- Crowder Crowderframe • Hager 9630/9631
- Johnson 1500 • Sterling 1630

## JOHNSON

## BY-PASS DOOR HARDWARE

### 1166 Series - By-pass Door

By-pass Track and Hardware for 3/4" or 1-3/8" doors up to 50 lbs.

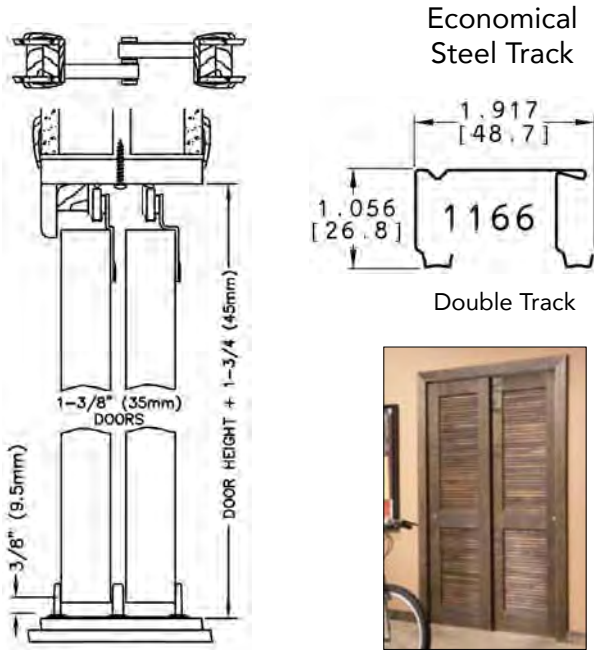

Economical Steel Track

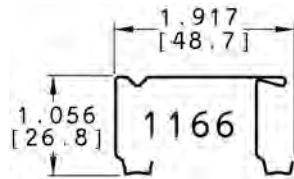

Double Track

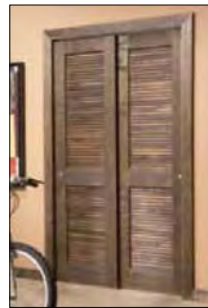

A gold colored steel by-pass track. Convex track rails provide one point contact between wheel and track. One wheel (7/8" dia.) hangers with 3 point locking. 1" high woodtone adjustable door guide. Brass-tone steel parts. Ref. Stanley 40-3000 Series.

	Track	Description	List/ea
	1166-0048	48" - 2 doors	\$ 9.19
	1166-0060	60" - 2 doors	13.34
	1166-0072	72" - 2 doors	13.57
	1166-0096	96" - 4 doors	18.33

### By-pass Hardware Set



Includes: hangers, guide and pulls. Each set is for 2 doors.

Code	Description	List/set
22310002	By-pass Hardware Set	\$ 10.33

### Extra Floor Guides



Code	Description	List/ea
2134	For 1-1/8" OR 1-3/4" doors	\$ 2.66
2135	For 3/4" OR 1-3/8" doors	1.70
2138	Plastic guide, 1-3/8" doors	1.28

### 2200 Series - By-pass Door

By-pass Track and Hardware for 3/4" or 1-3/8" doors up to 50 lbs.

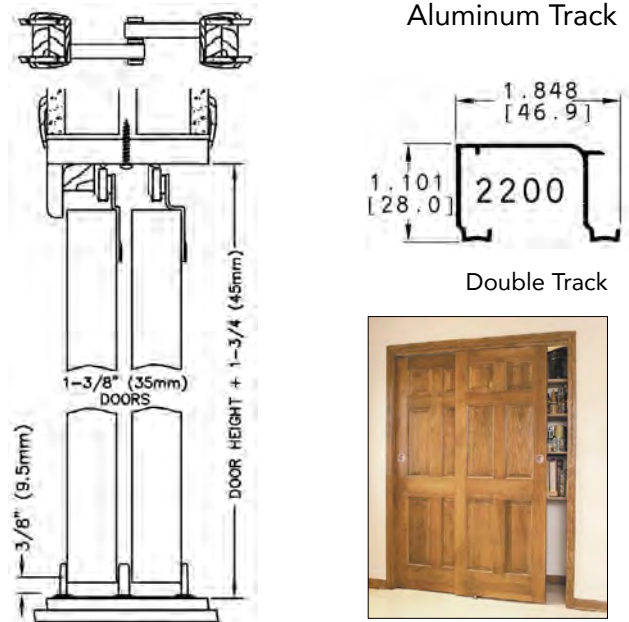

Aluminum Track

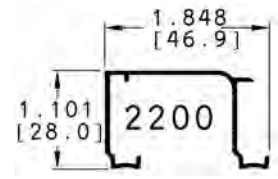

Double Track



Aluminum by-pass track for quiet, smooth operation. One wheel (7/8" dia.) hangers with 3 point locking. Convex track rail for single point wheel contact. 1" high woodtone adjustable door guide. Brass-tone steel parts. Ref. Stanley 54-1200 Series.

	Track	Description	List/ea
	2200-0048	48" - 2 doors	\$ 10.64
	2200-0060	60" - 2 doors	13.18
	2200-0072	72" - 2 doors	15.70
	2200-0096	96" - 4 doors	21.36

### By-pass Hardware Set



Includes: hangers, guide and pulls. Each set is for 2 doors.

Code	Description	List/set
22310002	By-pass Hardware Set	\$ 10.33

### Extra Floor Guides



Code	Description	List/ea
2134	For 1-1/8" OR 1-3/4" doors	\$ 2.66
2135	For 3/4" OR 1-3/8" doors	1.70
2138	Plastic guide, 1-3/8" doors	1.28



## BY-PASS DOORS

## POCKET DOORS

### 100SD Series - By-pass

Heavy Duty By-pass Track and Hardware for 1" or Thicker Doors up to **200 lbs.**

### 100PD Series - Pocket Door

Commercial Grade Pocket Door Hardware for 1" or Thicker Door up to **125 lbs. (200 lbs. w/ #10311005 set)**

4

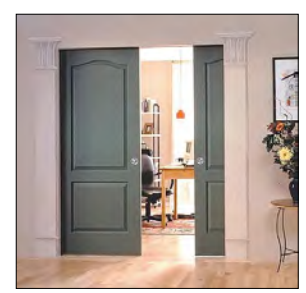
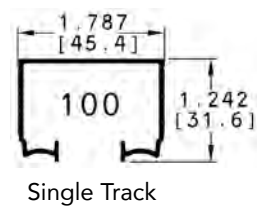
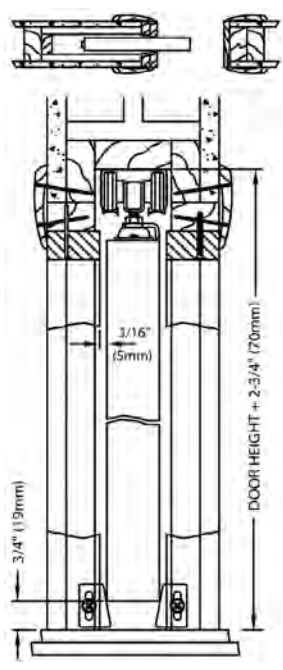
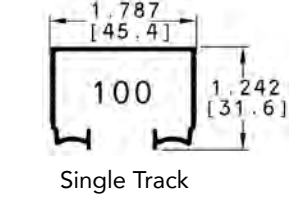
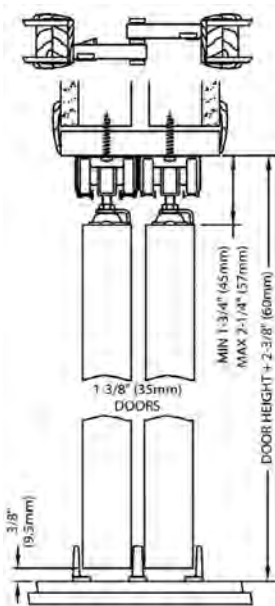

Commercial By-pass sliding door hardware set for doors up to 200 lbs. each. Heavy-duty aluminum box track uses 3-wheel ball bearing rollers (#1125) with 1" dia. wheels. Door guide adjustable for different thicknesses of doors. (min door thickness is 1") Ref. Stanley 40-5100 Series.

Can be used for pocket doors or in combination with itself to make special installations of sliding doors. Aluminum track with convex rails, jump proof 3-wheel (1" dia.) hangers for a smooth, quiet operation. Brass-tone steel parts. Ref. Stanley 40-5100 Series.

Track	Size	Ctn	List/ea
100-0048	48"	25	\$ 14.53
100-0060	60"	25	18.98
100-0072	72"	25	28.58
100-0096	96"	10	40.36
100-0144	144"	10	62.13

Track	Size	Ctn	List/ea
100-0048	48"	25	\$ 14.53
100-0060	60"	25	18.98
100-0072	72"	25	28.58
100-0096	96"	10	40.36
100-0144	144"	10	62.13

### By-pass Hardware Set



Includes: hangers, guide, stop, pull and wrench. Each set is for 2 doors.

Code	Description	List/set
10311012	By-pass Hardware Set	\$ 78.19

### Pocket Door Hardware Sets



Includes: hangers, guide, bumper and wrench. For one door.

10311002

Pack: 25 sets

### Spare Parts

101U  
 Universal  
 Floor Guide



2138  
 Door Guide  
 1-3/8"

Code	Description	List/ea
101U	Floor Guide (3/4" - 2-1/4" doors)	\$ 1.61
2138	Door Guide, 1-3/8"	1.28

Code	Description	List/set
10311002	Hardware Set, 125 lb. door	\$ 17.52
10311005	Hardware Set, 200 lb. door	41.56

10311005

## SOFT CLOSE SETS



## HANGERS

### Soft Close for Johnson 100SD and 100PD

Use with 100 Series Track



**Soft Close  
Hanger Set #1060SC**

- Doors up to 200 lbs. are smoothly braked then pulled into a closed position
- Use with Sliding and Pocket Door Hardware (100 Series Track)
- Min Door thickness: 1"
- Soft Close or Soft Open only, Min door Width: 24"
- Soft Close and Soft Open, Min door Width: 28"



Set includes:

- Soft Close Assembly
- Actuator Arm
- #1121 Hanger plate
- Adjustment wrench
- Mounting screws

### For Soft-Close in one direction on a single door (Min door width required is 24"), order:

- 1 ea. Track (e.g. 100-0060)
- 1 ea. 1125H or 1120H Hanger set
- 1 ea. 1060SC Soft Close Assembly

### For Soft-Close and Soft-Open on a single door (Min door width required is 28"), order:

- 1 ea. Track (e.g. 100-0060)
- 2 ea. 1060SC Soft Close Assembly

Code	Description	Ctn	List/ea
1060SC	Soft Close Hanger Set	25	\$ 56.86

Track	Size	Ctn	List/ea
	100-0048	48"	25 \$ 14.53
	100-0060	60"	25 18.98
	100-0072	72"	25 28.58
	100-0096	96"	10 40.36
	100-0144	144"	10 62.13

### Heavy Duty Hangers #1125H

Heavy Duty Ball Bearing Hanger. Comes with Top Mount Hanger Plate and screws. **200 lb capacity.** Nylon encapsulated Ball Bearing Wheels. Use one hanger with 1060SC Soft Close Hanger for 1-way soft close.



1125H

### Standard Wheel Hangers #1120H

Standard Duty Solid Nylon Wheel Hanger Set. **125 lb capacity,** 1" Wheel diameter. Comes with Top Mount Hanger Plate and screws.



Code	Description	List/ea
1125H	Heavy Duty Hanger	\$ 16.99
1120H	Std. Duty Hanger	5.70



## BI-FOLD DOORS

## BARN DOOR SETS

### 100FD Series - Bi-fold

Top Mounted Bi-fold Hardware for 1" - 1-3/4" Thick Panels up to **75 lbs.**

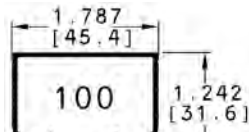
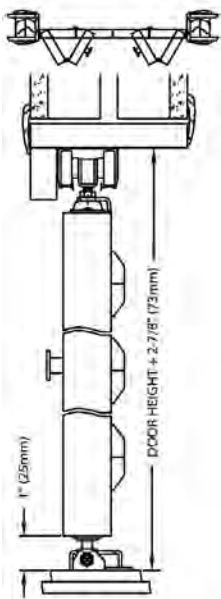

Single Track

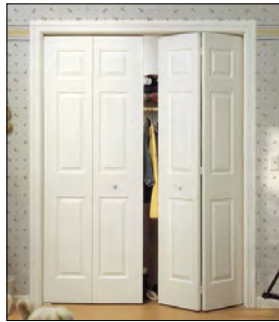

Order Track and 2 Hardware sets for 4 Doors.

Commercial Bi-fold Hardware set for 12" - 24" panels up to 9', 75 lbs each. Convex rail aluminum track with positive pivot lock, top hung, 3-wheel (1" dia) ball bearing hangers and non-mortise lift off hinges. Floor bracket has a screw adjusting bottom pivot socket. Brass-tone steel parts. Ref. Stanley 40-5300 Series.

Track	Size	Ctn	List/ea
100-0048	48"	25	\$ 14.53
100-0060	60"	25	18.98
100-0072	72"	25	28.58
100-0096	96"	10	40.36
100-0144	144"	10	62.13

### Bi-fold Hardware Set



Includes: pivots, stop, hinges, knob, hangers, wrench and aligner. Each set is for 2 door bi-fold.

Code	Description	List/set
1031FD02	Bi-fold Hardware Set	\$ 45.41

### Spare Parts (Already included in Hardware Set)

Code	Description	List
109PIV-S	Pivot Set (1 set)	\$ 22.28/st
1606	Bifold hinges (1 pr)	3.17/pr
1808	Aligner (1 set)	.68/st

421

### 2610F Series - Barn Door Track

Wall Mounted Fascia Track and Hardware for 1" to 1-3/4" Thick Door up to **125 lbs. (200 lbs. w/ #26311005 set)**

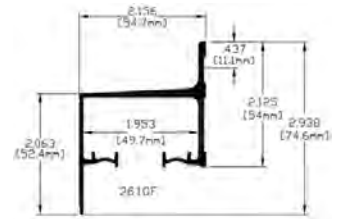
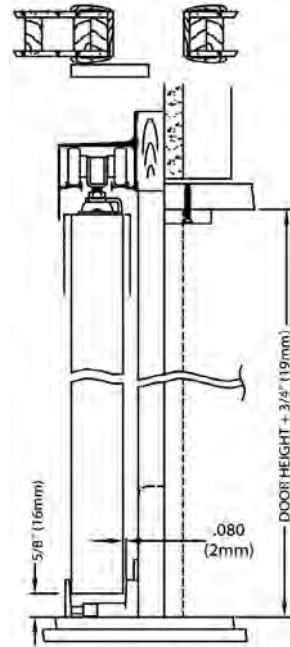

Single Track w/Fascia

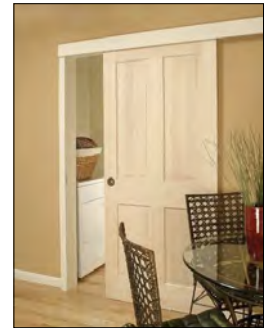

Surface mounted hardware set for open pocket doors. Use to slide a door along the wall rather than in the wall. Aluminum track with convex rails, jump proof 3-wheel (1" dia.) hangers for a smooth, quiet operation. Also includes a wall-mounted door guide. Brass-tone steel parts.

Track	Description	List/ea
2610F-0072	72", for one 3' door	\$ 68.42
2610F-0096	96", for one 4' door	69.55
2610F-0144	144" length track	109.91



26311003

### Barn Door Hardware Sets

Includes: 2 hangers, 2 stops, 1 guide, 2 end caps and wrench. For one door.



26311005

Code	Description	List/set
26311003	Hardware Set, 125 lb. door	\$ 28.97
26311005	Hardware Set, 200 lb. door	31.62



**Cross Reference**

Johnson • Stanley • Grant

<b>Johnson</b>	<b>Stanley Equal</b>	<b>Grant</b>
<b>By-Passing, Steel Track &amp; Hardware</b>		
1166-0048 (track)	40-3006, BPC60-00-48 (track)	
1166-0060 (track)	40-3008, BPC60-00-60 (track)	
1166-0072 (track)	40-3010, BPC60-00-72 (track)	
1166-0096 (track)	40-3012, BPC60-00-96 (track)	
22310002 (hdwe set)	54-1252, BP60-HDW-3 (hdw set)	
<b>By-Passing, Aluminum Track &amp; Hardware</b>		
2200-0048 (track)	54-1232, BPC60A-00-48 (track)	6004-4
2200-0060 (track)	54-1236, BPC60A-00-60 (track)	6004-6
2200-0072 (track)	54-1240, BPC60A-00-72 (track)	6004-8
2200-0096 (track)	54-1264, BPC60A-00-96 (track)	6004-12
22310002 (hdwe set)	54-1252, BP60-HDW-3 (hdw set)	6034/6064 (50-75 lb)
<b>Heavy Duty, By-Pass Track &amp; Hardware</b>		
100-0060 (track)	-	
100-0072 (track)	40-5104 (track)	7003-6
100-0096 (track)	40-5105 (track)	1201-8 7003-8
100-0144 (track)	40-5107 (track)	1201-12 7003-12
10311012 (hdw set)	150 lb. hdw set = 40-5860 250 lb. hdw set = 64690 (hangers) + 40-3534 (floor guide)	1210 (225 lb) 1230 (325 lb) 72-138/134 (150 lb)
<b>Bi-Fold Track &amp; Hardware</b>		
100-0060 (track) (75 lbs/door, 2 doors)	40-2322 (track) (50 lbs/door, 2 doors)	
100-0072 (track) (75 lbs/door, 2 doors)	40-2323 (track) (50 lbs/door, 2 doors)	
100-0096 (track) (75 lbs/door, 2 doors)	40-2324 (track) (50 lbs/door, 2 doors)	1201-8
100-0144 (track) (75 lbs/door, 2 doors)	-	1201-12
1031FD02 (Bi-Fold hdw set)	40-2308 (pivots) + 40-2303 (hangers)	1260 (175 lb)
<b>Pocket Door Hardware</b>		
100-0060 (track)	-	
100-0072 (track)	40-5104 (track)	7001-6
100-0096 (track)	40-5105 (track)	7001-8
100-0144 (track)	40-5107 (track)	
10311002 (125 lb. hdw set) or 10311005 (200 lb. hdw set)	64690 (top hangers) plus 40-3993 (1-3/8" door guide) or 40-3997 (1-3/4" door guide)	71-222



## BI-FOLD DOOR SYSTEM

## DUCASSE

### **BI-FOLD CLOSET SYSTEM** PL2550 - 2 Panel Carrier Set



Folding system for doors installed to overlay the opening. Ideal for closet applications. Includes Euro hinges to fix the door to the lateral. The system can be applied to right or left door.

- Load Capacity: **44 lbs/door.**
- Door Thickness: 3/4"
- Max. Door Width: 19-11/16"
- Min. Door Frame Height: 1-3/4"
- Ultra-smooth and quiet aluminum track with ball-bearing rollers.

#### **PL2550** carrier set for 2 panels



Carrier PL2550

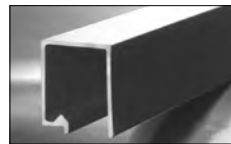

Track PL25

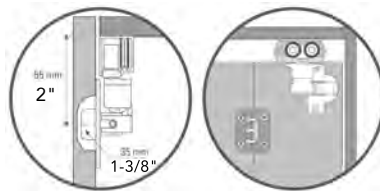

Carrier Installation

Code	Description	List
011303	PL2550, Carrier Set for 2 panels	\$ 55.15
021PL251	PL25 Track 6.5'	44.63
021PL252	PL25 Track 9.85'	54.59

## DUCASSE

## BI-FOLD DOOR SYSTEM

### BI-FOLD DOOR SYSTEM

DN 80 PL 2 Folding System for 2 heavy doors

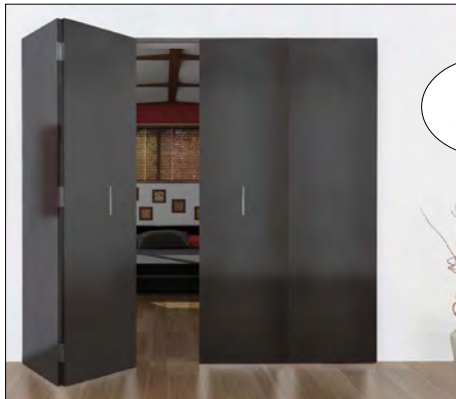

For 2  
Doors

- Load Cap: **88 lbs/door**, ANSI-BHMA, Grade 1
- Ultra-smooth and quiet, aluminum track and ball-bearing rollers
- For doors up to 29-1/2"
- Min door thickness: 13/16"



Carrier Installation

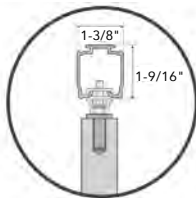

Track Installation

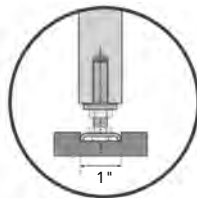

Lower Pivot Installation



Carrier DN 80 PL

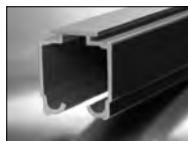

Track U21



#### DN 80 PL 2 set for 2 panels

A	1 Carrier DN 80	
B	1 Upper fixed base/pivot	
C	1 Lower fixed base/pivot	
D	3 Central hinges	
E	Regulation key	
F	1 Aligner	
G	1 Mounting plates	
H	Screws	

Code	Description	List
013301	DN 80 PL 2, 2 panels carrier	\$ 47.67
021U211	DN 80 CF Track 6.5'	82.40
021U21-8	DN 80 CF Track 8'	91.05
021U21-12	DN 80 CF Track 12'	139.03
021U213	DN 80 CF Track 19.7'	273.50

### BI-FOLD DOOR SYSTEM

DN 80 PL 4 Folding System for 4 heavy doors



For 4  
Doors

- Load Cap: **88 lbs/door** ANSI-BHMA, Grade 1
- Ultra-smooth and quiet, alum track and ball-bearing rollers
- For doors up to 29-1/2"
- Min door thickness: 13/16"

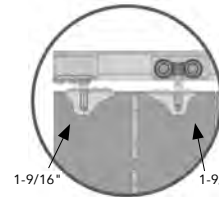

Carrier Installation

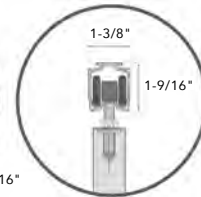

Track Installation



Guide Installation



Carrier DN 80 PL



Track U21

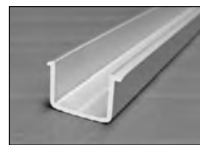

Floor Guide Track

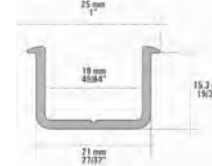

#### DN 80 PL 4 set for 4 panels

A	2 Carrier DN 80	
B	1 Upper fixed base/pivot	
C	1 Lower fixed base/pivot	
D	6 Central hinges	
E	2 Guides GC-16	
F	Regulation key	
G	1 Aligner	
H	2 Mounting plates	
I	Screws	

Code	Description	List
013302	DN 80 PL 4, 4 panels carrier	\$ 91.24
021U211	DN 80 CF Track 6.5'	82.40
021U21-8	DN 80 CF Track 8'	91.05
021U21-12	DN 80 CF Track 12'	139.03
021U213	DN 80 CF Track 19.7'	273.50
10100608020	Guide Track PL, AL, 6.5'	\$ 25.51
101006080-08	Guide Track PL, AL, 8'	29.13
10100608030	Guide Track PL, AL, 9.85'	41.29
101006080-12	Guide Track PL, AL, 12'	50.06



# TOP FOLDING DOOR SYSTEM

# DUCASSE

## Concealed Top Folding System for Wood Doors Tauro Wood PLMD - 50

### Configuration Examples

4



#### 2 Panel Kit

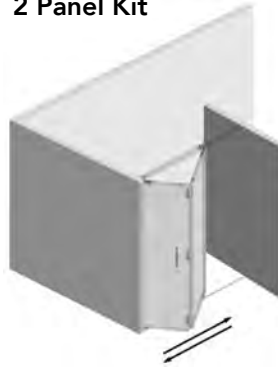

TAURO WOOD 2 Panel KIT	
PART NUMBER: 1030001451	
(A)	1 Carrier set, Tauro PLMD 50
(B)	1 upper pivot set PLMD 50
(C)	1 Lower pivot set PLMD 50
(D)	3 Concealed hinges
(E)	1 Bottom roller guide
(F)	4 PLMD End caps
(G)	4 Mounting plates
(H)	1 Spring Aligner
(I)	1 Bracket Aligner
(J)	1 Segmenta Key
(K)	1 Segmenta 01 Key
(L)	Screws

#### 2 Panel Kit and 2 Panel Kit

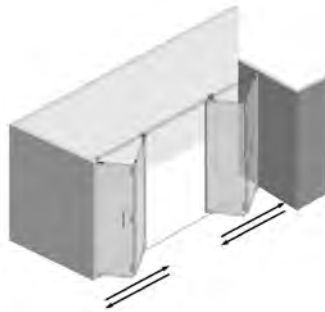

Kit + 2 Panels TAURO WOOD	
PART NUMBER: 1030001453	
(A)	1 Set Tauro PLMD 50
(B)	1 Bottom roller guide
(C)	2 PLMD End Caps
(D)	2 Mounting plates
(E)	6 Concealed hinges
(F)	1 Spring Aligner PLMD
(G)	1 Bracket Aligner PLMD
(H)	1 Segmenta key
(I)	Screws

#### 2 Panel Kit and +2 Panels

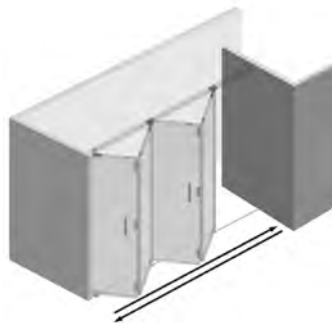

#### 2 Panel Kit and Pivot Door Kit

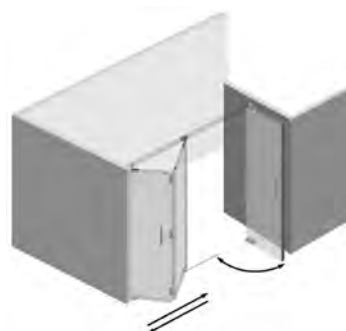

Pivot Door Kit TAURO WOOD	
PART NUMBER: 1030001455	
(A)	1 Upper pivot set PLMD 50
(B)	1 Lower Pivot set PLMD 50
(C)	2 PLMD End Caps
(D)	2 Mounting plates
(E)	1 Spring Aligner PLMD
(F)	1 Segmenta key
(G)	Screws

- Up to **110 lbs**/panel and max of 660 lbs in the stacking area
- Modular system: up to six panels per side
- For partitions, meeting rooms, family rooms
- Concealed "Soss" type hinges for a clean look when closed
- Floor Guide track for smooth folding
- Concealed bottom roller guide with height adjustment
- Spring-aligner keeps doors flat in a closed position
- Top bracket-aligner will prevent over extension of doors
- Maximum flexibility to make your own set up
- Door Thickness: 1-19/64" min
- Max Door Width: 29-1/2"
- Gap between Door and Track: 5/16"
- Gap between Door and Floor: 7/64"



1010060569-12  
U150 Track  
Smooth 12'



101006080-12  
Guide Track 12'

Code	Description	List
10300001451	Tauro Wood <b>2 Panel Kit</b>	\$ 1803.62
10300001453	Tauro Wood Kit <b>+2 Panels</b>	1184.89
10300001455	Tauro Wood <b>Pivot Door Kit</b>	936.19
1010060569-12	U150 Smooth, 12'	392.25
101006080-12	Guide Track PL, 12'	50.06

## DUCASSE

## CLOSET SYSTEMS

### **TOP SLIDING CLOSET** CA 4585 System for Wood Doors

- Load capacity: **66 lbs/door**
- 8 safety clips assure that the door will not jump out of the track
- Aluminum anodized double tracks for easy installation
- Ball bearing quality rollers for silent, smooth glide
- Min door thickness: 3/4"



Track U28



Carrier CA 4585



#### **CA 4585** Carrier set for 2 doors

- |          |                              |  |
|----------|------------------------------|--|
| <b>A</b> | 4 Carriers CA4585            |  |
| <b>B</b> | 2 R Stoppers<br>2 L Stoppers |  |
| <b>C</b> | 3 Plastic Guides             |  |
| <b>D</b> | 8 Safety Clips               |  |
| <b>E</b> | 1 Allen Key                  |  |
| <b>F</b> | Screws                       |  |

Track U28  
 For Door  
 Thickness:  
 3/4" - 7/8"

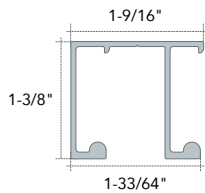

Track U28-35  
 For Door  
 Thickness:  
 3/4" - 1-3/8"

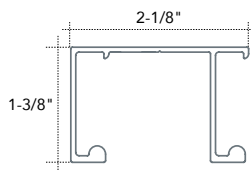

Code	Description	List
011205	CA 4585 Carrier set for 2 doors	\$ 42.67
021U281	Double Track U28 AL, 6.5'	47.42
021U28351	Double Track U28-35 AL, 6.5'	56.57
021U28352	Double Track U28-35 AL, 9.85'	85.01

### **FLOOR SLIDING CLOSET** CD 40 CX System for Wood or Aluminum Doors

- Load capacity: **88 lbs/door**
- Multiple doors can be installed side by side for longer openings
- Options of flush or surface mount carrier tracks
- Double aluminum track allows for an easy and fast installation
- Ball bearing quality rollers for silent, smooth glide
- Min door thickness: 5/8"



Top Guide GD50 AL

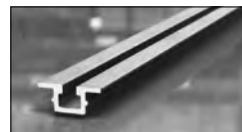

Flush Mount Track  
 CXE AL

#### **CD 40 CX** Carrier set for 2 doors

- |          |                                      |  |
|----------|--------------------------------------|--|
| <b>A</b> | 4 Carriers CD 40 CX                  |  |
| <b>B</b> | 2 Upper R guides<br>2 Upper L guides |  |
| <b>C</b> | 4 Stoppers w/<br>retention device    |  |
| <b>D</b> | 4 Secure Locks                       |  |
| <b>E</b> | 1 M5 Key                             |  |
| <b>F</b> | Screws                               |  |

Carrier  
 Bore:  
 38-40mm

Code	Description	List
011103	CD 40 CX, Carrier set for 2 doors	\$ 64.02
031D501	Top Guide GD50 AL, 6.5'	37.93
031D502	Top Guide GD50 AL, 9.85'	56.90
021CXE1	Flush Mt Track CXE AL, 6.5'	10.77
021CXE2	Flush Mt Track CXE AL, 9.85'	18.34

## TOP SLIDING DOOR SYSTEM

## DUCASSE

### TOP SLIDING SYSTEM DN 50 for Wood Doors up to 110 lbs.



- Top sliding system for wood doors up to 110 lbs.
- Ideal for light pocket door applications and bypass closet doors
- Min door thickness: 3/4", minimum gap 1/2" between door and track
- Optional lateral brackets for barn door installations
- Carrier with enclosed ball bearings seals out dust and grime

Track U45 AL

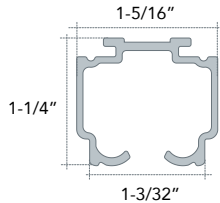
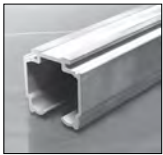

**DN 50**  
 set for 1 door

- 2 Carriers DN 50
- 2 Stoppers with retention device
- 1 Floor guide GP-12
- 2 Mounting plate
- Screws



Carrier DN 50

Balanced Movement



Code	Description	List
10100217271	DN 50, set for 1 door	\$ 46.06
021U45-08	Track U45 AL, 8'	62.32
021U45-12	Track U45 AL, 12'	92.47

### TOP SLIDING SYSTEM DN 50 SP Kit for Wood Doors up to 110 lbs.



- Top sliding system kit for wood doors up to 110 lbs.
- Complete Kit to install one door overlaying the opening (barn door style) or standard top mount without the fascia, brackets and caps.
- Carrier with enclosed ball bearings seals out dust and grime
- Stoppers inside the track retain the door in position



DN50SP-KIT

**DN50SP-KIT**  
 contains:

- 2 Carriers DN 50
- 2 Stoppers with retention device
- 1 Floor guide GPR 850
- 2 Mounting plate
- 1 Track U45 2m (6.5ft)
- 1 Concealed Bracket Fascia 2m (6.5ft)
- 6 Concealed Brackets
- 1 End Cap set for Connector
- Screws
- Nuts and Bolts

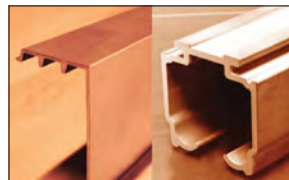

Fascia / Track U45 AL



Hidden Connector / Cap

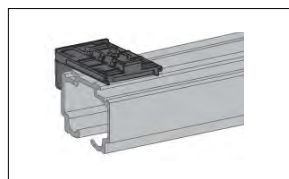

Concealed Brackets

Code	Description	List
DN50SP-KIT	DN 50 SP Kit (includes hdwr & 6.5' U45 Track for 1 door)	\$ 221.71

## DUCASSE

## CLOSET SYSTEMS

### TOP SLIDING CLOSET DN 50 CLIP System for Wood Doors/Clip-On Carrier

- Load capacity: **110 lbs/door**
- Clip-on installation feature provides fast and easy mount and dismount.
- Extremely quiet movement
- Stoppers installed inside the track will retain the door in position
- Min door thickness: 3/4" - 1-3/8", minimum gap 2mm between door and track



#### Clip-On Carrier

- Height adjustable
- Sealed ball bearings



Carrier  
 DN 50 Clip

#### Track U45 AL

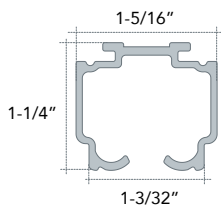
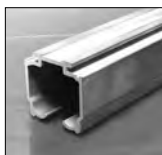

#### DN 50 CLIP set for 2 doors



### FLOOR SLIDING CLOSET D 52 System for Wood or Aluminum Doors

- Load capacity: **110 lbs/door**
- Multiple doors can be installed side by side for longer openings
- Carrier can be installed **inset** for minimum 12mm gap between doors, or **surface mounted** for 15mm gap
- Ball bearing rollers for silent, smooth glide

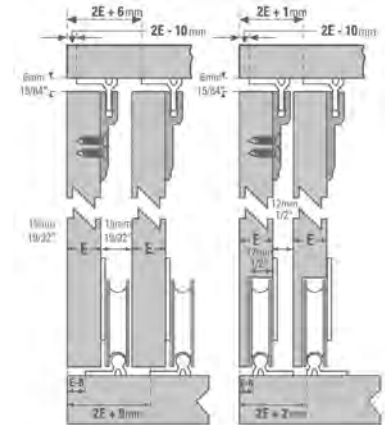
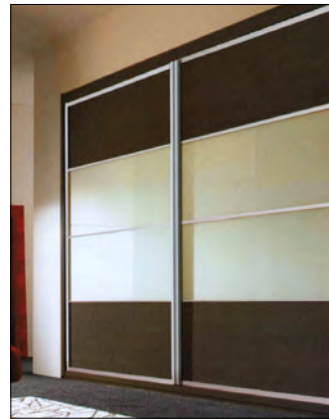

Overlay  
 Carrier

Inset  
 Carrier



Carrier D 52

#### D 52

set for 2 doors

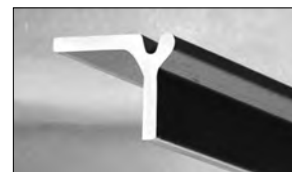
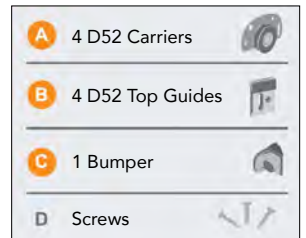

Guide Track D 52 AL

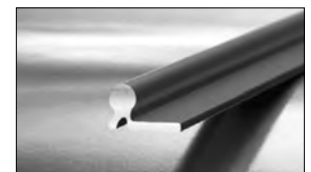

Carrier Track D 52 AL

Code	Description	List
10100256051	DN 50 Clip set for 2 doors	\$ 92.47
021U45-08	Track U45 AL, 8'	62.32
021U45-12	Track U45 AL, 12'	92.47

Code	Description	List
10100106201	D 52 Set for 2 Doors	\$ 46.39
1010058200	Guide D 52 AL, 6.5'	15.24
1010058300	Guide D 52 AL, 9.85'	23.36
1010057200	Track D 52 AL, 6.5'	15.24
1010057300	Track D 52 AL, 9.85'	23.36



# TOP SLIDING DOOR SYSTEM

# DUCASSE

4



## TOP SLIDING DOOR SYSTEM

DN 80 CF for Wood or Aluminum Doors, **176 lb /door**

- **176 lb.** load capacity, ANSI-BHMA Grade 1
- Ultra-smooth and quiet, aluminum track and ball-bearing rollers
- Minimum Door Thickness: 13/16"
- Door-Track Gap: 17 - 23mm, Door-Floor Gap: 10mm
- Instop holds door - No bounce
- Standard inlay installation
- Optional Easy Soft avoids doors from bumping and ensures the doors are always closed (see next page)
- Optional U21 Fascia and End Caps easily connect to track with a snap providing a clean, solid and elegant look (see page 435-436)



Carrier DN 80 CF



Carrier Installation

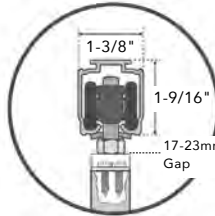

Track Installation

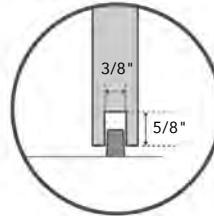

Guide Installation

### DN 80 CF set for 1 door



### Available Tracks for DN 80 CF Top Sliding Door System

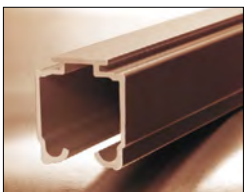

Track U21

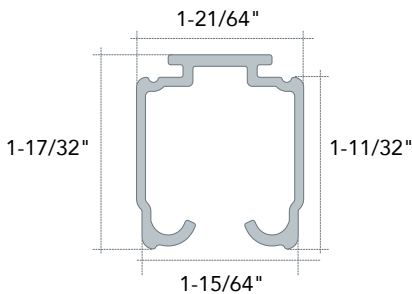

Track U21 RT (Smooth)

A finished look for seamless exposed track.

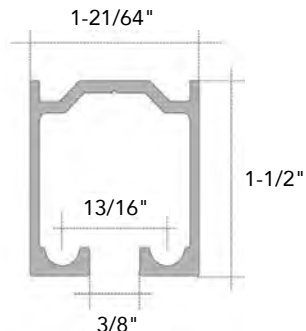

### Carriers

Carrier	Description	List
013203	DN 80 CF, Set for 1 Door	\$ 65.47

### Tracks

021U211	Track DN 80 CF, 6.5'	82.40
021U21-8	Track DN 80 CF, 8'	91.05
021U21-12	Track DN 80 CF, 12'	139.03
021U213	Track DN 80 CF, 19.7'	273.50
10100626082	Track U21 RT AL Smooth, 6.5'	81.62
10100626083	Track U21 RT AL Smooth, 9.85'	122.61
1010062608-12	Track U21 RT AL Smooth, 12'	158.16



## DUCASSE

## SOFT CLOSE TOP SLIDING

- Easy Soft DN 80**  
 Concealed Soft-Close for Doors  
 between 110 - 176 lbs.



### Soft Close for Sliding Doors

The Easy Soft DN 80 is a soft close system made of 2 parts: 1 Easy Soft DN 80 Kit and 1 Annex Kit. Use 1 Easy Soft DN 80 for soft close in one direction only. Use 2 of them for soft close in both directions.

Finished opening height - door height: 2-7/8" (73mm)  
 Finished floor to door bottom: 7/16" - 5/8" (10-15mm)  
 Top of door to bottom of track: 13/16" - 1" (20-25mm)

4

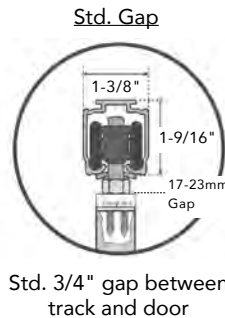
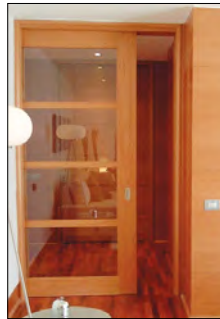

### Easy Soft DN80 CF Annex Kit : Door Thickness ≥ 13/16" (20mm)

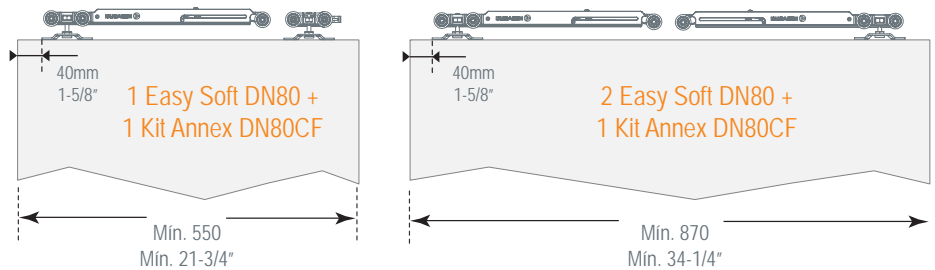

### Easy Soft DN 80 CF/ For 1 door #10107026485

- 1 Soft Close DN 80
- 1 ES Activator
- 1 DN 80 Carrier
- 1 Stopper with retension device
- Screws



Track U21



Track U21 RT (Smooth)

### Annex Kit DN 80 CF

Pack: 10/Ctn



- 2 DN 80 CF mounting plates
- 2 Carrier bolts
- 4 Hex Nuts
- 1 Guide GPR 850
- Screws

### How To Order DN 80 Soft Close

**For DN 80 Soft-Close in one direction on a single door (Min door width required is 21-3/4"), your order would be:**

- 1 set 10107026485 Easy Soft DN80
- 1 ea. 10107026486 Annex Kit
- 1 ea. 021U21 Track (specify length) or U21 RT AL (Smooth) Track (see prev pg.)

**For DN 80 Soft-Close in two directions (Soft-Close and Soft-Open) on a single door (Min door width required is 34-1/4"), your order would be:**

- 2 sets 10107026485 Easy Soft DN80
- 1 ea. 10107026486 Annex Kit
- 1 ea. 021U21 Track (specify length) or U21 RT AL (Smooth) Track (see prev pg.)

Code	Description	List
10107026485	Easy Soft DN 80 CF	\$ 154.68
10107026486	Annex Kit DN 80 CF	13.55
021U211	DN 80 CF Track 6.5'	82.40
021U21-8	DN 80 CF Track 8'	91.05
021U21-12	DN 80 CF Track 12'	139.03
021U213	DN 80 CF Track 19.7'	273.50



## TOP SLIDING DOOR SYSTEM

## DUCASSE

### SLIDING DOOR SYSTEM DN Concealed LT, 176 lbs/ door

1/8" gap  
Between Door  
and Track

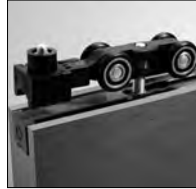

Carrier DN 80  
Concealed LT

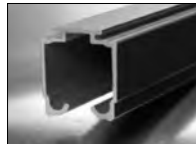

Track U21

- 1/8" gap between door and track
- 176 lb. load capacity
- Minimum Door Thickness: 1-1/8"
- Ultra-smooth and quiet, aluminum track and ball-bearing rollers
- Instop holds door - No bounce.  
(Not for pocket door installation)



Carrier  
Installation



Tight  
Gap

Track  
Installation

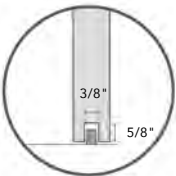

Guide  
Installation

### DN 80 Concealed LT set for 1 door



Code	Description	List
013213	DN 80 Concealed LT, set for 1 door	\$ 99.76
021U211	DN 80 CF Track 6.5'	82.40
021U21-8	DN 80 CF Track 8'	91.05
021U21-12	DN 80 CF Track 12'	139.03
021U213	DN 80 CF Track 19.7'	273.50

Note: Can also be used with U21 RT AL (Smooth) Track (see page 435).

### TOP SLIDING DOOR SYSTEM DN 80 Concealed FT, 176 lb/ door

1/8" gap  
Between Door  
and Track



- 1/8" gap between door and track
- 176 lb. load capacity
- Minimum Door Thickness: 1"
- Mounting plates allow for "lift-up" installation, **Ideal for pocket doors**



Carrier DN 80  
Concealed FT

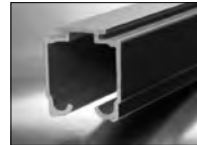

Track U21

### DN 80 Concealed FT set for 1 door



Fixed Panel  
Track Installation

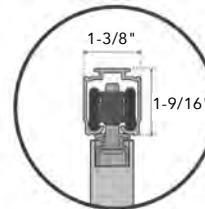

1/8" gap between  
track and door

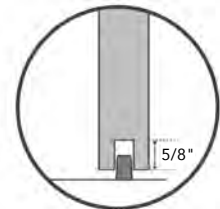

Guide  
Installation

Code	Description	List
013206	DN 80 Concealed FT, set for 1 door	\$ 111.73
021U211	DN 80 CF Track 6.5'	82.40
021U21-8	DN 80 CF Track 8'	91.05
021U21-12	DN 80 CF Track 12'	139.03
021U213	DN 80 CF Track 19.7'	273.50

Note: Can also be used with U21 RT AL (Smooth) Track (see page 435).

## DUCASSE

## TOP SLIDING DOOR SYSTEM

### **SYNCHRO TWIN TELESCOPING WOOD** Load Capacity: 176 lbs. per door



- For 2 by-passing **synchronized** doors that will open in the same direction with only one movement
- Allows for door widths up to 60"
- Ball bearing high quality rollers for a silent smooth glide
- No bounce: Instop holds door
- Stoppers with retention device concealed in the track
- Door thickness: 13/16" to 1-3/8"
- Door-Track Gap: 1"
- Door-Floor Gap: 25/64"

#### Twin Telescopic Wood Kit for 2 Doors

#10300001399 includes:

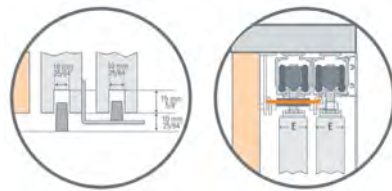
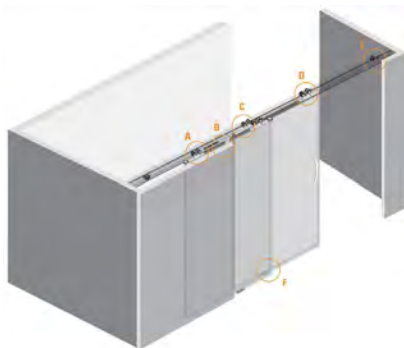

Guide Installation      13/16" > E < 1"

- 176 lbs. ANSI - BHMA Grade 1
- Ultra-smooth, quiet
- Use the DN 80 Track

Code	Description	List
10300001399	Twin Telescopic Kit for Wood	\$ 714.99
021U211	DN 80 CF Track 6.5'	82.40
021U21-8	DN 80 CF Track 8'	91.05
021U21-12	DN 80 CF Track 12'	139.03
021U213	DN 80 CF Track 19.7'	273.50

### **SYNCHRO TWIN OPPOSITE WOOD** Load Capacity: 176 lbs. per door



- System for **synchronized** doors that will open in opposite directions by only opening one door
- Allows for door widths up to 60"
- Door can be installed to overlay the opening or 'barn door' style using wide lateral brackets
- Ball bearing high quality rollers for a silent smooth glide
- Stoppers with retention device concealed in the track
- No bounce: Instop holds door
- Door thickness: 13/16" to 1-1/2"
- Door-Track Gap: 1"
- Door-Floor Gap: 25/64"

#### Twin Opposite Wood Kit for 2 Doors

#10300001404 includes:

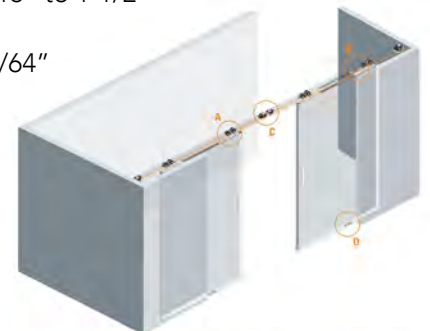

Carrier Installation      Track Installation      Guide Installation

- Use the DN 80 Track

Code	Description	List
10300001404	Twin Opposite Kit for Wood	\$ 714.99
021U211	DN 80 CF Track 6.5'	82.40
021U21-8	DN 80 CF Track 8'	91.05
021U21-12	DN 80 CF Track 12'	139.03
021U213	DN 80 CF Track 19.7'	273.50

# TOP SLIDING DOOR SYSTEM

# DUCASSE

## HEAVY DUTY TOP SLIDING DOOR SYSTEM DN 150 CF, Load Cap: 330 lbs/ door



- **330 lb.** load cap, ANSI-BHMA Grade 1
- Ultra-smooth and quiet, aluminum track and ball-bearing rollers
- Minimum Door Thickness: 1-3/16"
- Instop holds door - No bounce
- Lateral Bracket 023BRAU21W will allow installation of the track to the wall ("Barn Door" effect)

Install Easy Soft DN 150 for **Soft Close** Feature - see next column for details.

### DN 150 CF Set for 1 door

- A** 2 Carriers DN 150 CF
- B** 2 Stoppers with retention device
- C** 1 Floor Guide
- D** 2 Mounting Plates
- E** 1 Segmenta Key
- F** Screws



Carrier DN 150 CF

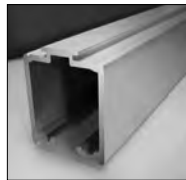

Track U150 AL



Track Installation



Guide Installation

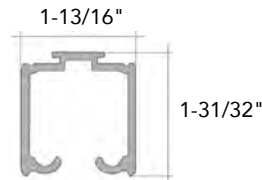

Code	Description	List
013220	DN 150 CF Hardware Kit	\$ 138.60
021U1501	Track U150 AL, 6.5'	159.23
021U1502	Track U150 AL, 9.85'	239.00
021U1504	Track U150 AL, 12'	324.82
021U1503	Track U150 AL, 19.7'	554.55
023BRAU21W	"Barn Door" Wide Bracket	36.61

## EASY SOFT DN 150

Provides **Soft Close** for 1 Door (Use with DN 150 systems)

- Load capacity: 187-330 lbs/door
- System made of 2 components: The Easy Soft DN 150 and Kit Annex Easy Soft DN 150. Combinations of both provide 1 door with 1 or 2 soft closes (see below)
- System hidden in track making it a concealed soft close
- Avoids doors from bumping and insures the doors are always closed



Easy Soft DN 150  
 Includes door guide and mounting hardware

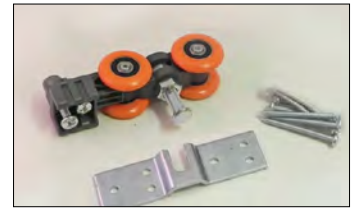

Kit Annex Easy Soft DN 150  
 Includes carrier, stops and mounting hardware

Installation with Soft Close on 1 side:

1 Easy Soft DN 150 + 1 Kit Annex DN 150

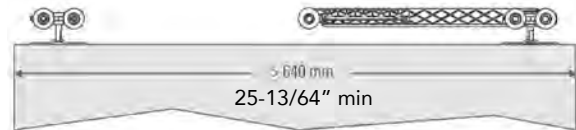

Installation with Soft Close on 2 sides:

2 Easy Soft DN 150



**How To Order DN 150 Soft Close**  
 Min Door Thickness of 1-3/16"

**For DN 150CF Soft-Close in one direction on a single door (Min door width required is 25-13/64"), order:**

1 set	10107026510 Easy Soft DN150	List \$ 304.82
1 ea.	10107026520 Annex Kit DN150	67.74
1 ea.	Track (see choices left column)	

**For DN 150CF Soft-Close in two directions on a single door (Min door width required is 39-3/4"), order:**

1 set	10107026510 Easy Soft DN150	List \$ 304.82
1 ea.	Track (see choices left column)	

## DUCASSE

## TOP SLIDING DOOR SYSTEM

### TOP SLIDING PARTITION DN 150 Concealed FT for Pocket Doors

- Load capacity: **330 lbs/door**
- FT Carrier allows **smaller gap** between door/track
- Door-Track Gap: 16mm, Door-Floor Gap: 4mm
- Unique mounting plates allow for a 'lift up' installation; ideal for pocket door solutions
- Optional wide barn door brkt and fascia for U150 track
- Ball bearing high quality rollers for silent, smooth glide
- Min door thickness: 1"



**DN 150 FT**  
 carrier set  
 for 1 door



Carrier DN 150 FT  
 330 lbs/door

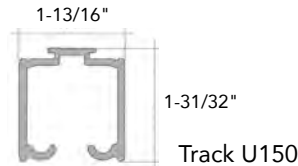
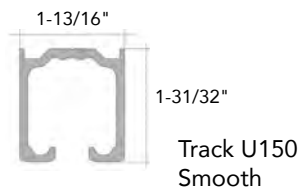

Code	Description	List
10100219525	Carrier Set for 1 door	\$ 230.32
1010060569-08	Track U150 Smooth AL, 8'	218.79
10100605693	Track U150 Smooth AL, 9.85'	266.89
1010060569-12	Track U150 Smooth AL, 12'	392.25
10100605696	Track U150 Smooth AL, 19.7'	533.43
021U1501	Track U150 AL, 6.5'	159.23
021U1502	Track U150 AL, 9.85'	239.00
021U1504	Track U150 AL, 12'	324.82
021U1503	Track U150 AL, 19.7'	554.55

**Install Easy Soft DN 150 for Soft Close Feature - see previous page for details.**

### TOP SLIDING FOR INDUSTRIAL DOORS HD300, Load Cap: **660 lbs/ door**



Top sliding system with tempered steel wheels covered in nylon for doors up to 660 lbs. The mounting plate can be welded. Use on Wood or Metal Doors for Exterior Barn Door, Garage, or Access Doors applications. Use with Track U150 Smooth Heavy Duty Track.

- Mounting plate allows for easy frontal installation
- Wheel of high hardness and durability
- No need for lubrication
- The right adjustment eliminates vibrations



**2012030000**  
 Kit for One Door

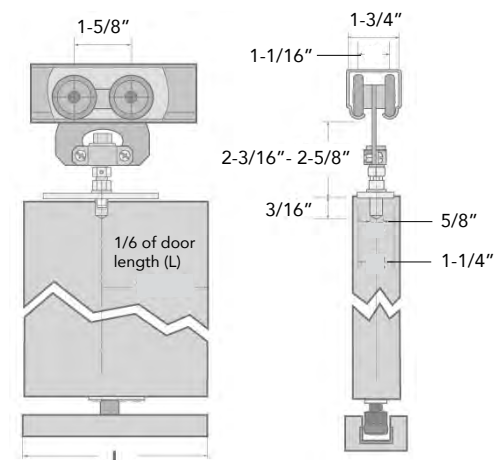

Code	Description	List
2012030000	HD-300 Heavy Duty Carrier Kit for 1 Door	\$ 398.00
1010060569-08	Track U150 Smooth AL, 8'	218.79
10100605693	Track U150 Smooth AL, 9.85'	266.89
1010060569-12	Track U150 Smooth AL, 12'	392.25
10100605696	Track U150 Smooth AL, 19.7'	533.43



## DUCASSE TRACK

### TRACK U21 AL

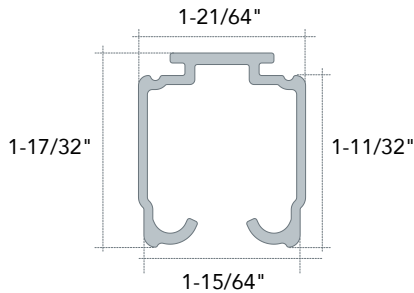
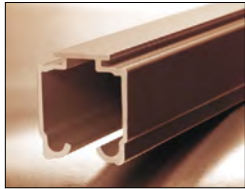

Track U21

Use with: DN 80 CF, DN 80 LT, DN 80 FT, DN 80 PL2, DN 80 PL4, Twin Telescopic Wood (and Glass), Twin Opposite Wood (and Glass), Barn Door Brackets

Code	Description	List/ea
021U211	Track DN 80 CF, 6.5'	\$ 82.40
021U21-8	Track DN 80 CF, 8'	91.05
021U21-12	Track DN 80 CF, 12'	139.03
021U213	Track DN 80 CF, 19.7'	273.50

### TRACK U21 RT (SMOOTH):

A finished look for seamless exposed track

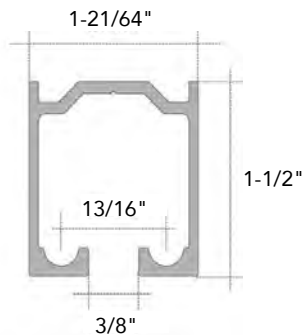

Track U21 RT (Smooth)

A finished look for seamless exposed track.

Use with: DN 80 CF, DN 80 LT, DN 80 FT, DN 80 PL2, DN 80 PL4, Twin Telescopic Wood (and Glass), Twin Opposite Wood (and Glass), Barn Door Brackets

Code	Description	List
10100626082	Track U21 RT AL Smooth, 6.5'	\$ 81.62
10100626083	Track U21 RT AL Smooth, 9.85'	122.61
1010062608-12	Track U21 RT AL Smooth, 12'	158.16

### TRACK U150 AL: Heavy duty track

Use with: DN 150 CF, DN 150 VD

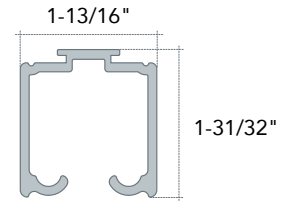
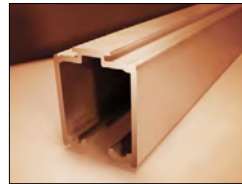

Code	Description	List
021U1501	Track U150 AL, 6.5'	\$ 159.23
021U1502	Track U150 AL, 9.85'	239.00
021U1504	Track U150 AL, 12'	324.82
021U1503	Track U150 AL, 19.7'	554.55

### TRACK U150 (SMOOTH) Heavy duty track, finished look

Use with: Tauro PLMD Wood, Tauro PLVD Glass, DN 150 CF, DN 150 VD

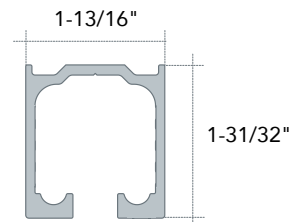
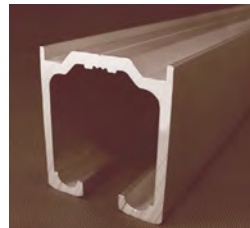

Code	Description	List
1010060569-08	Track U150 Smooth AL, 8'	\$ 218.79
10100605693	Track U150 Smooth AL, 9.85'	266.89
1010060569-12	Track U150 Smooth AL, 12'	392.25
10100605696	Track U150 Smooth AL, 19.7'	533.43

### U21 END CAP For U21 Track

Accessory for U21 Track to install when the ends of the track are visible.

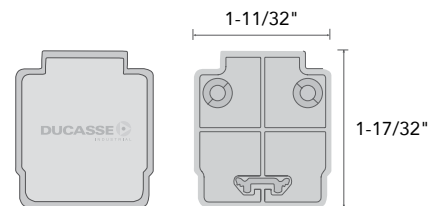

Code	Description	List/pr
10100910020	U21 End Cap	\$ 8.75



## DUCASSE

## ACCESSORIES

### U21 END CAP W/ FASCIA

For U21 Track w/ Fascia

Accessory for U21 Track and U21 Double Track with Fascia to install when the ends of the track are visible. Not for use on "Smooth" style track.



10100910018

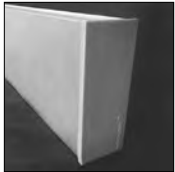

10100910019

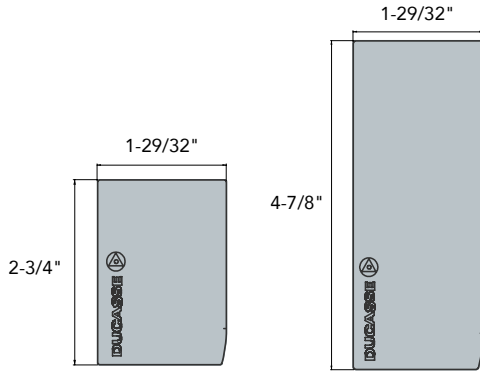

Code	Description	List/pr
10100910018	U21 End Cap w/ 2-3/4" Fascia	\$ 13.88
10100910019	U21 End Cap w/ 4-7/8" Fascia	24.35

### U21 FASCIA

For U21 Track or U21 Double Track

Anodized aluminum fascia for U21 track. It gives a clean and elegant look to your project. Available in 2 different heights and various lengths. Not for use on "Smooth" style track.

Fascia U21  
66mm Ht (2-5/8")

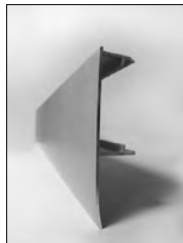

Code	Description	List
041U21661	Fascia U21, 2-5/8" Ht, 6.5'	\$ 56.97
041U21662	Fascia U21, 2-5/8" Ht, 9.85'	85.18
041U2166-12	Fascia U21, 2-5/8" Ht, 12'	88.62

### FLOOR GUIDE - 17.5 MD

Use with Floor Guide Track PL

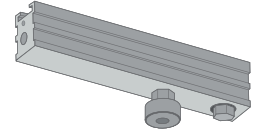

Code	Ctn	List/ea
10300001460	8	\$ 145.25

### GUIDE TRACK PL

Use with: DN80 PL4, Tauro PLMD Wood, Tauro PLVD Glass

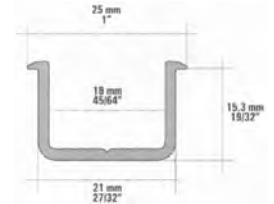

Code	Description	List
10100608020	Guide Track PL, AL, 6.5'	\$ 25.51
101006080-08	Guide Track PL, AL, 8'	29.13
10100608030	Guide Track PL, AL, 9.85'	41.29
101006080-12	Guide Track PL, AL, 12'	50.06

4



## ACCESSORIES

## DUCASSE

### "BARN DOOR" BRACKETS

Allows Door Track to be installed on wall.



023BRAU21



021BRAU21W

Standard bracket available in 3-7/8" lengths,  
Wide brackets available in 2m (6.5') and 3m (9.85') lengths.

Standard

Wide

Lateral Installation



31.2mm  
1-1/4"



44.7mm  
1-3/4"



Std.

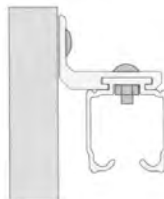

Wide

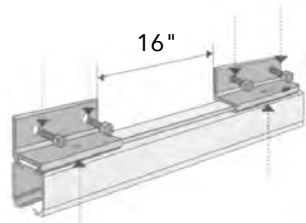

16"

Std. Brackets should be installed 16" or less apart from each other.

### Can be used with:

DN 80 CF, DN 80 Concealed FT, DN 80 Concealed LT

### Small Brackets: 3-7/8" Length, Packed: 2 per bag.

Code	Description	List/bg
023BRAU21	Standard Bracket, 1-1/4"	\$ 18.24

### Long Brackets: 2 Lengths avail, Packed: 10 ea/Ctn.

Code	Description	List/ea
021BRAU21W-2	Wide Bracket, 1-3/4" x 2m (6.5 ft)	\$ 77.90
021BRAU21W-3	Wide Bracket, 1-3/4" x 3m (9.85 ft)	116.85

### Track

Description	List
DN 80 CF Track 6.5'	\$ 82.40
DN 80 CF Track 8'	91.05
DN 80 CF Track 12'	139.03
DN 80 CF Track 19.7'	273.50

### LATERAL DOOR BRACKETS FOR DN50 AND DN80

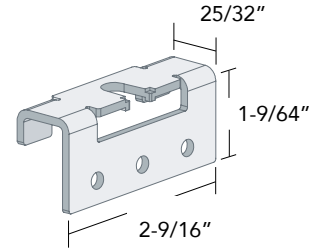
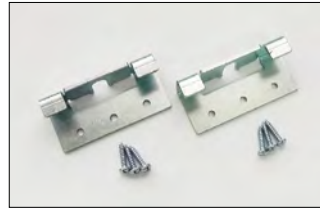

- Can be used with wooden or aluminum profile doors weighing from 110 - 176 lbs.
- Allows DN50 and DN80 CF carriers to be mounted sideways to the door
- Ideal for use in low density wood doors, MDF and aluminum profiles.

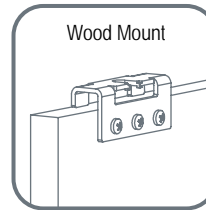

Wood Mount

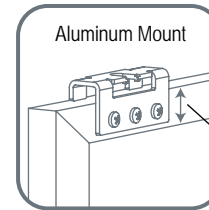

Aluminum Mount

3/4"

Code	Description	Ctn	List/ea
10100217284	Lateral Door Brackets for DN50 / DN80 CF Carriers	20	\$ 19.46

### WALL BRACKET TELESCOPIC LOWER GUIDE

Use with DN 50/LT, DN 80 CF/LT/FT, DN 150 CF/FT

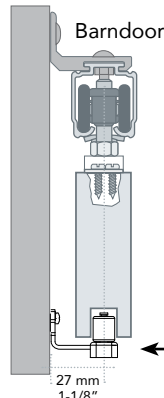

To be installed on the wall when installing a floor guide is difficult. Has 3 positions to adjust for different door thicknesses.

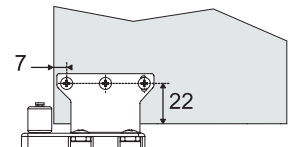
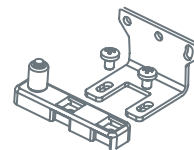

Code	Ctn	List/ea
WBTLG	100	\$ 21.89



## FLAT TRACK

## BARN DOOR HARDWARE

### BARN DOOR HARDWARE SETS

Flat Rail Surface Mounting - Retail View Pack Kits



#### Set Includes:

- 5 Clamps for Fixing Track
- 2 Door Stoppers
- 1 Rail, Length 6.5' or 8'
- 2 Anti Jump Blocks
- 2 Sliding Door Rollers
- 1 Floor Guide
- Screws and Allen Key

- 6.5' and 8' Track Sets available
- Carbon Steel Matte Black w/ Powder coat and Stainless Steel finishes available
- Max. Door Weight: 350 lbs. (160 kg)
- For door thickness of 1-1/4 to 1-3/4"

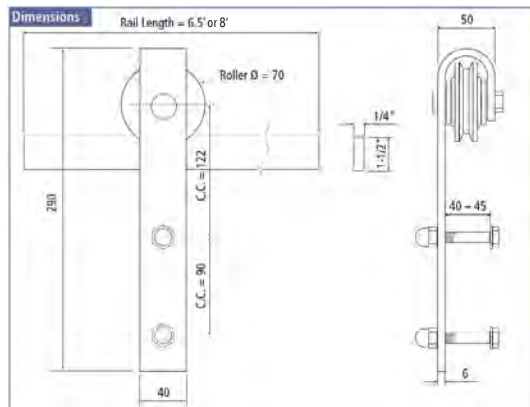

FT-MB Flat Rail Surface Mount Specs

#### FRC-MB

Flat Rail Connector, Matte Black.  
 Used to splice flat track together.

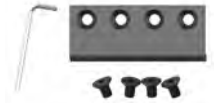

#### FT-SC-MB Soft Close for FT-MB-6 and FT-MB-8



Max Load of 176 lbs.

Overall Dimensions:  
 13-3/8" x 15/16" x 13/16"

#### FT-BC-MB

Bypass Door Bracket for Flat Rail. Enables double door solutions with two rails. Steel with Matte Black powder coat.



Code	Description	Finish	List
FT-MB-6	Surface Mount, 6.5'	Matte Black	\$ 294.65/st
FT-MB-8	Surface Mount, 8'	Matte Black	363.04
FT-SS-6	Surface Mount, 6.5'	Stnless Steel	389.00
FRC-MB	Flat Rail Connector	Matte Black	9.46/ea
FT-SC-MB	Soft Close for Flat Track	Matte Black	60.83
FT-BC-MB	Bi-pass Door Bracket	Matte Black	29.00

### BARN DOOR HARDWARE SETS

Mini Surface Mount Flat Track Sets - Retail View Pack Kits



#### Set includes:

- 2 Door Stoppers
- 1 Rail, Length 5' 10"
- 2 Anti Jump Blocks
- 2 Sliding Door Rollers
- 1 Floor Guide
- Screws and Allen Key

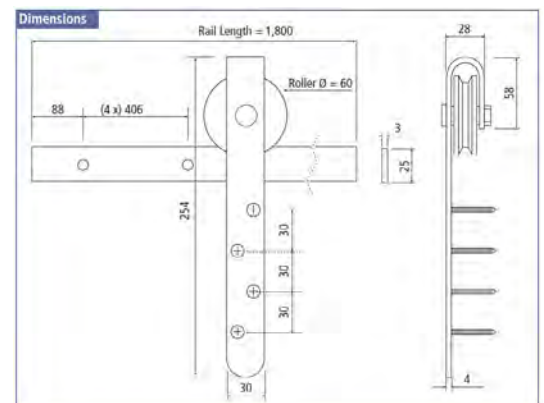

FT-MINI - Flat Rail Surface Mount Specs

- 5' 10" Track Set
- Carbon Steel Matte Black w/ Powder coat
- Max. Door Weight: 44 lbs. (20 kg)
- For door thickness of 1 to 1-3/16"

Code	Description	List/st
FT-MINI-MB	Mini Surface Mount, Matte Black Flat track set - Retail View Pack	\$ 188.20

## BARN DOOR HARDWARE



### Flat Track by Leatherneck Hardware, Inc. Designer Sliding Door Hardware

Flat Track Hardware styling dates back to the turn of the century when it was used in warehouses and industrial settings. Today this look is perfect for unique interior/exterior applications. The hardware can be customized for specific applications, is space saving, and will enhance any opening. Available in clean, simple styling or can be designed to be ornate depending on the application. Comes in several finishes and styles.

Capacities are 400 lb and 800 lb units.

Flat Track Hardware is available for order in complete kits for single slide openings. The hardware can also be ordered as individual components.



- Drop Ship, FOB Danville, Illinois
- Check out [www.doorhdwe.com](http://www.doorhdwe.com) for more information

### 142 Standard Hanger Styles / 400 lbs.



401  
Arrowhead



402  
Straight



403  
Horseshoe



403 DBHH  
Double Bar Horseshoe



407  
Top Mount



409  
I-Shape



410  
Teardrop



411  
Wide Teardrop



413  
Swivel

### 144 Hanger Styles / 800 lbs.

21" Length



404  
Teardrop



405  
Straight



406 Industrial  
Wide Teardrop

### Wheels

3" Standard Steel Wheels  
 (avail in all finishes)



Other Wheel Styles Available:

**2-1/2" Low Profile Steel Wheels, 3" Quiet Wheels** (made from durable polymer material) and New **Aluminum Spoke Wheels 402S:** a highly stylized 6" Wheel (7 wheel designs). Interchangeable with #142 Hanger Styles.

### Please note the following:

To compose a complete order for one 1-3/4" door, the following items are needed:

- 2 Hangers
- 1 Flat Track
- 2 Door Stops
- 2 Anti-Jump Blocks
- 1 Fin Guide
- Mounting Screws  
 (amount dependent on track size)



### Finishes



00 Flat Black



90 Brushed  
Nickel



05 Antique  
Bronze



01 New  
Penny



80 Painted  
Bronze



27 Clear  
Coated



25 Unfinished



74 Machined  
Copper



30 Machine  
Polished



60 Weathered  
Rust



50 Brushed  
Stainless Steel



40 Mill Finish  
Stainless Steel



## BARN DOOR HARDWARE



### Leatherneck Hardware Kits

The following Leatherneck Kits Include:

- 2 ea. #402 Straight Hangers
- 1 ea. #142 Flat Track
- 2 ea. Door Stops
- 2 ea. Anti-Jump Blocks
- 1 ea. Fin Guide
- Mounting Screws  
(amount dependent on track size)



4

Kit - Black Finish			Kit - Brushed Nickel			Kit - Painted Bronze		
		List			List			List
1024-0001	5' Track	\$ 438	1024-9001	5' Track	\$ 487	1024-8001	5' Track	\$ 444
1024-0002	6' Track	444	1024-9002	6' Track	490	1024-8002	6' Track	451
1024-0003	7' Track	462	1024-9003	7' Track	506	1024-8003	7' Track	478
1024-0004	8' Track	468	1024-9004	8' Track	514	1024-8004	8' Track	486

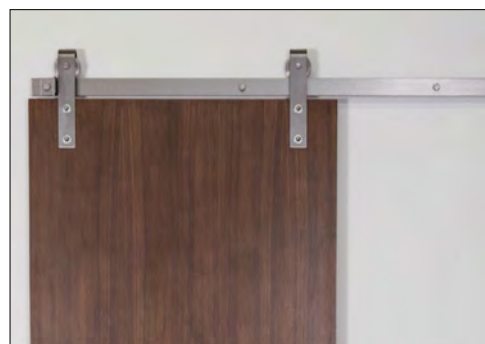
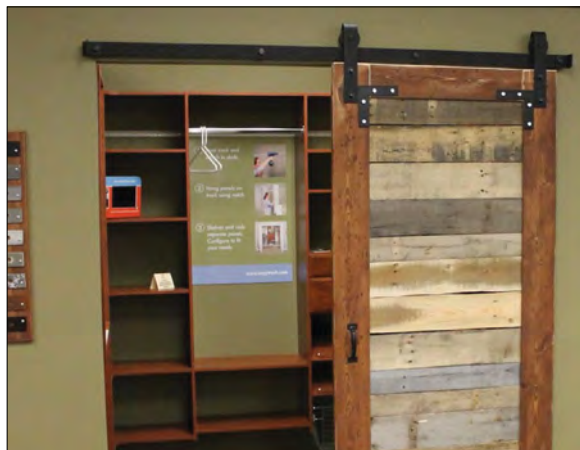



# CABINET SLIDING SYSTEM

# DUCASSE

## **CABINET SLIDING SYSTEM** AL 1535 for 2 Wood Doors

- Load Capacity: **33 lbs/door**, ANSI-BHMA, Grade 1
- 2 panels can be installed left or right. 2 sets installed in opposite directions can close an opening up to 10'.
- Ball bearing quality rollers for a silent, smooth glide
- Min door thickness: 5/8" wood

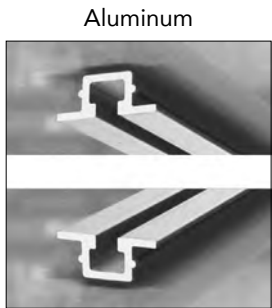

Carrier Track CXE  
Flush mount top/bottom



Carrier  
AL 1535 Wood

### **AL 1535 for Wood Doors** set for 2 doors

<b>A</b>	4 Carriers AL1535	
<b>B</b>	4 Top guides with clip device	
<b>C</b>	4 Stoppers with retention device	
<b>D</b>	Screws	

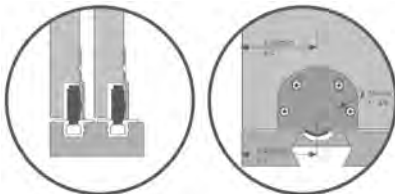

Carrier Installation  
35mm edge bore

Code	Description	List
012103	AL 1535 for Wood Doors, Set for 2 Doors	\$ 35.06
021CXE1	CXE Inset AL 1535, 6.5'	10.77
021CXE2	CXE Inset AL 1535, 9.85'	18.34

## **CABINET SLIDING SYSTEM** AL 1535 for 2 Glass Doors

- Load Capacity: **33 lbs/door**, ANSI-BHMA, Grade 1
- Clip on upper guide allows for easy mount and dismount of door
- Anodized aluminum track flush mounted for a concealed clean look

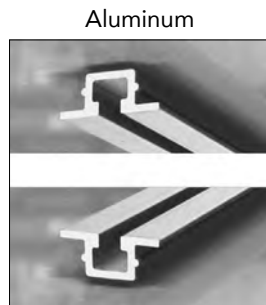

Carrier Track CXE  
Flush mount top/bottom



Carrier AL 1535 Glass

### **AL 1535 for Glass Doors** set for 2 doors

<b>A</b>	4 Carriers AL1535	
<b>B</b>	4 Top guides w/ clip device	
<b>C</b>	8 Finishing caps	
<b>D</b>	4 Stoppers with retention device	
<b>E</b>	Screws	

Carrier  
Installation

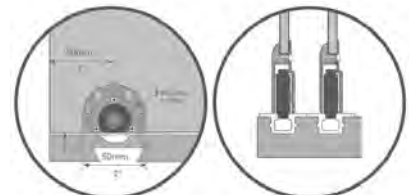

Code	Description	List
012102	AL 1535 for Glass Doors, Set for 2 Doors	\$ 38.22
021CXE1	CXE Inset AL 1535, 6.5'	10.77
021CXE2	CXE Inset AL 1535, 9.85'	18.34

## DUCASSE

## FLOOR SLIDING SYSTEM

### FURNITURE FLOOR SLIDING AL 1540 Floor Sliding System for Wood/Alum Doors

- Load capacity: **33 lbs/door**
- FCX track allows for **overlay** door installation - can be installed directly on the cabinet face frame
- CXE track allows for **inset** door installation
- Ball bearing quality rollers for a silent and smooth glide
- Stoppers installed inside the track will hold the door in position
- Min door thickness: 5/8"

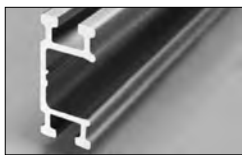

Carrier Track FCX

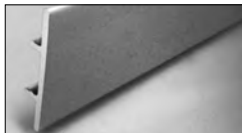

Fascia LX



Carrier Track CXE Aluminum



#### AL 1540 carrier set for 1 door

- A** 4 Carriers AL 1540
- B** 2 Stoppers
- C** 4 Track Endcaps
- D** Screws

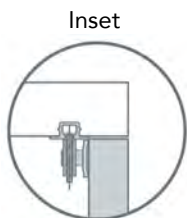

Track CXE for door inset

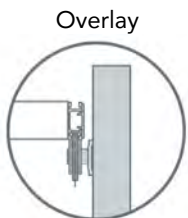

Track FCX for door overlay



Carrier Installation

Code	Description	List
012404	AL 1540 Hardware Kit for 1 Door	\$ 35.23
021FCX2	AL 1540 Overlay Track FCX, 9.85'	32.51
041ALX2	AL 1540 Fascia LX, 9.85'	21.34
021CXE1	AL 1540 Flush Mnt Track CXE, 6.5'	10.77
021CXE2	AL 1540 Flush Mnt Track CXE, 9.85'	18.34

### FURNITURE FLOOR SLIDING CD 30 CX Floor Sliding System for Wood/Alum Doors



- Load capacity: **66 lbs/door**
- Easy installation of flush mounted aluminum track
- Carriers can be flush mounted or surface mounted
- Min door thickness: 5/8"

#### Aluminum

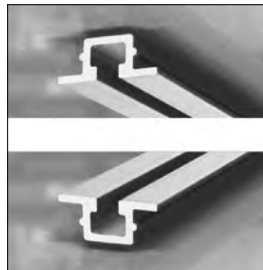

Carrier Track CXE  
 Flush mount top/bottom



Carrier CD 30 CX

#### CD 30 CX carrier set for 1 door

- A** 2 Carriers CD30CX
- B** 2 Top guides CD30CX with clip device
- C** 2 Stoppers AL 1535
- D** Screws

#### Frontal View

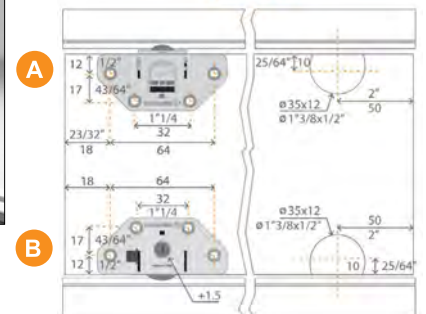

Code	Description	List
10100117092	CD 30 CX Carrier Set, Set for 1 Door	\$ 32.92
021CXE1	Track CXE AL, 6.5'	10.77
021CXE2	Track CXE AL, 9.85'	18.34

## SLIDING DOOR HARDWARE

### HAWA JUNIOR 80/B Kit

Concealed Sliding System for Wood Doors, 176 lbs.



4

- 176 lb. Door capacity
- Min Door thickness: 1-3/16"
- Smooth, quiet operation, outstanding durability
- Rattle-free bottom guide
- Simple installation
- Special two-way suspension: bracket allows the door to be hung and to be taken off either from the side or front
- Vertically and laterally adjustable
- Door stop with adjustable retention spring
- Soft Close mechanism available separately

HAWA-Junior 80/B Kit with 2 Meter (78-3/4") Top Track		
	Two-wheeled trolley, M10, with plastic wheels	2
	Top fixed suspension with plate and hanger bolt M10	2
	Track stop, adjustable retaining force	2
	Screw-on rubber door stop	1
	Guide, rattle proof, for screw mounting to floor; groove width 10 mm (3/8"), black plastic	1
	Vertical adjustment pin	1
	2000 (6'6") Top track, anodized, predrilled	1

HAWA-Junior 80/B kit with 2m (78 3/4") upper track, two track stoppers and hardware for one wood door weighing up to 80 kg (176 lb).

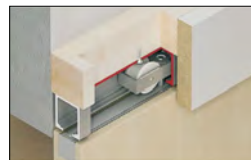

### HAWA JUNIOR Soft Move

Use with Hawa Junior 80 Series Sliding Doors

JUNIOR80-SOFT

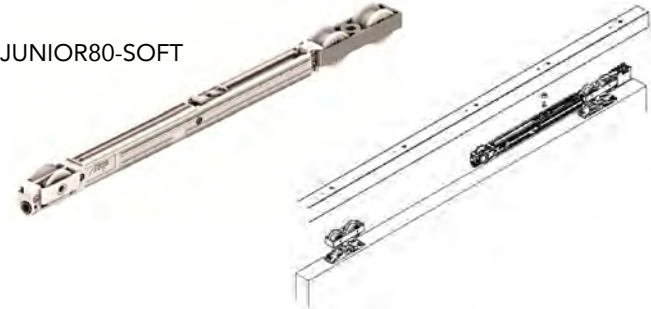

The SoftMove soft-closing mechanism is an accessory for all Hawa-Junior 40-80-120 systems suitable for both wood and glass sliding doors. The mechanism is completely integrated into the upper running track. Gently slows sliding doors and draws them into their final position. Quick and easy to install with included installation aids. Uses a high quality hydraulic damper that is very quiet, with long lasting and maintenance free materials.

Use with our stocking Hawa 80 Series sets for soft close. 176 lb. load capacity.

Min. door width for one sided soft-close: 27-3/16"

Min. door width for two sided soft-close: 40-9/16"

Code	Description	List/st
JUNIOR80-SOFT	Hawa Junior80 SoftMove	333.76

Code	Description	List
JUNIOR80B-SET	Hawa Junior 80B Set w/ 2M Track	\$ 878.47
JUNIOR80-SOFT	Hawa Junior80 Softmove	333.76

## SLIDING DOOR HARDWARE

### HAWA JUNIOR 80/Z - Top Sliding Door System

For Wood Doors, 176 lbs. per door



1 set per door,  
 Order hardware  
 set and track  
 separately

- Min Door Thickness: 1"
- 176 lbs. Door capacity
- Simple installation
- Rattle-free bottom guide
- Soft Close avail. separately

- Smooth and quiet operation, outstanding durability
- Special two-way suspension: bracket allows the door to be hung and to be taken off either from the side or front
- Vertically and laterally adjustable
- Door stop with adjustable retention spring

#### JUNIOR80-Z Set

Required



Kit Includes:

- (2) two-wheel carriages
- (2) two-way suspensions
- (1) adjustable track stopper
- (1) wall bumper
- (1) self locking bottom guide
- (1) height adjustment pin

#### JUNIOR80 Top Track

Required



JUNIOR80-2M

2M / 6.56'

JUNIOR80-2.5M

2.5M / 8.2'

JUNIOR80-3M

3M / 9.84'

JUNIOR80-4M

4M / 13.1'

#### Accessories



Bottom Guide



Track Stop (extra)

Code	Description	List
JUNIOR80-Z	Hardware set for 1 door	\$ 430.30
JUNIOR80-2M	2M (6.56') Top Track	156.63
JUNIOR80-2.5M	2.5M (8.2') Top Track	200.16
JUNIOR80-3M	3M (9.84') Top Track	164.42
JUNIOR80-4M	4M (13.1') Top Track	293.35
HAWA-GUIDE	Groove-Mount Bottom Guide, 1.3M (4.27')	35.30
JUNIOR80-STOPPER	Junior 80/Z Track Stop	47.77
JUNIOR80-SOFT	Hawa Junior80 Softmove	333.76

### HAWA FOLDING CONCEPTA 25

Bi-fold & Slide-In Pocket Doors



4

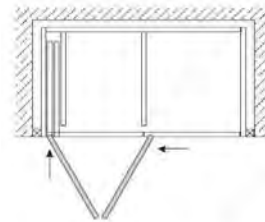

The HAWA-Folding Concepta 25 with soft-close hinges is a bi-fold and slide-in pocket door system for two leaves or door panels weighing up to 55 lb (25 kg) each, or 110 lb (50 kg) per bifold door panel. An ideal solution for kitchen pantries, home offices, laundry rooms, storage areas, closets, and self-serve food and beverage areas.

#### Features:

- Concealed hinge with soft-close mechanism
- Retractable device helps pull door into the pocket area
- Integrated dampeners for smooth operation
- Requires a small 2-7/8" (73mm) x 4-11/32" (110mm) space inside the pocket area to retract the mechanism
- Door width: 11-13/16" to 27-9/16"

#### Folding Concepta 25 - Max panel wt: 55 lbs.

Choose door height range and handing.

Code	Door Height	List
18927636 (LH)	49-1/4" - 72-7/8"	\$ 4317.72
18927637 (RH)	49-1/4" - 72-7/8"	4317.72
18927638 (LH)	72-7/8" - 102"	4675.34
18927639 (RH)	72-7/8" - 102"	4675.34

## SLIDING DOOR HARDWARE

### HAWA CONCEPTA SLIDE-IN HARDWARE KITS

with Soft Close Hinges

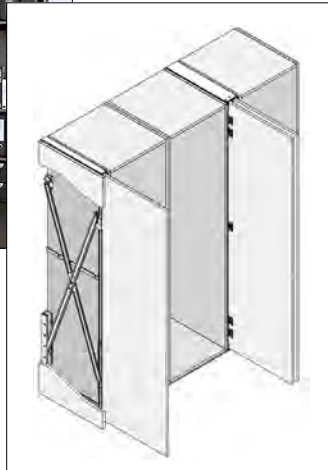

The HAWA-Concepta Series with Soft-Close Hinges for four pivot and slide-in pocket door systems for single doors weighing up to 110 lbs. each.

Slide doors alongside cabinet bodies or into wall recesses. Room-high designs and walk-in cabinets are easy and efficient to implement. No bottom guide channel needed. Offers optimum flexible room utilization with no protruding door obstructions.

#### Features:

- Concealed hinge with soft-close mechanism
- For doors up to 2" (50mm) thick
- Mechanism retracts into a small 2-7/8" parking area
- Single door thicknesses up to 1-1/4" park into an area 2-3/16" (55mm) wide
- Single door thicknesses up to 2" park into an area 3-5/16" (83 mm) wide
- Thicker doors possible up to 2" (50mm) when not using the connector brackets for decorative cover panels
- Integrated dampeners for smooth operation

Description	Max Door Weight	Door Height
Concepta 25	55 lbs.	4' 1-7/16" to 6' 27/32"
Concepta 30	66 lbs.	6' 7/8" to 7' 6-9/16"
Concepta 40	88 lbs.	6' 7/8" to 8' 2-7/16"
Concepta 50	110 lbs.	7' 6-19/32" to 9' 4-7/32"

Code	Description	List
18927648	Concepta 25	\$ 2074.06
18927649	Concepta 30	2334.35
18927650	Concepta 40	3046.44
18927651	Concepta 50	3052.68

### HAWA CLIPO BYPASS SLIDING DOOR SYSTEM

Set for 2 Doors



A top running sliding system for two wooden doors weighing up to 35 lbs each. The running gear is clipped into a 1-3/8" (35 mm) housing in the back of the door and the door height can be adjusted with the finger-operated adjustment wheel. Track can be recessed or surface mounted to a cabinet top. An optional soft-close mechanism (sold separately) is available for inside the track. The bottom of the cabinet does not require a lower guide track in the base.

893220071

Hardware set for 2 wood doors, 35 lbs. each.



1893229250

2.5M (98") Single Track to be used with Hardware set.



893332072

Soft-Close System for Clipo. Minimum door width of 24" (608 mm) for two soft-close mechanisms.



Code	Description	List
893220071	Clipo fitting set for 2 doors	\$ 250.76
1893229250	2.5m (98-3/8") track	75.10
893332072	Soft Close Clipo	121.93





# SALICE

# COPLANAR

## Coplanar Systems Special Order

Sliding is intuitive, smooth and silent. Ideal for units used in the kitchen and bathroom or for furniture intended for the living room, bedroom and offices. Call office for quotes, or visit macpac1.com under resources for order forms.

### Slider S10

Ideal for small units used in the kitchen and bathroom or for larger furniture intended for the living room, bedroom and offices. For doors weighing up to 22 lbs.



- Max. weight per door: 22 lbs
- Width from 17-11/16" to 47-1/4"
- Max. height: 31-1/2"
- Thickness from 5/8" to 1-3/16", max. 1-9/16" with handle
- Soft closing while opening and closing

### Slider S20

Ideal for cabinets used in the living area, offices, kitchen and sleeping area. For doors weighing up to 44 lbs.



- Available in the Standard, One, Step, Reverso and Power versions.
- Max. weight per door: 44 lbs
- Width from 23-5/8" to 59"
- Max. height: 47-7/32"
- Thickness from 3/4" to 1-3/4" with handle
- Vertical, horizontal & front door adjustment
- Soft closing while opening and closing

### Slider M35 Top

Can be used to open two identical coplanar doors, or a single sliding door paired with a hinged door or an open compartment. For medium-height top-hung cabinets with doors weighing up to 77 lbs.



- Available in the Standard, One, Step, Reverso and Power versions.
- Soft closing with magnetic technology
- Max. weight per door: 77 lbs.
- Width from 600 to 1500 mm.
- Height from 1200 to 1800 mm.
- Thickness from 18 to 40 mm with handle.
- Vertical, horizontal and front door adjustment

### Slider M50+

Ideal for wardrobes and storage cabinets in offices and shops. For full-height cabinets with doors weighing up to 110 lbs.



- Available in the Standard, One, Step and Reverso versions
- Soft closing with magnetic technology
- Max. weight per door 110 lbs.
- Width from 23-5/8" to 78-3/4"
- Max. height from 86-5/8" to 95-1/2"
- Vertical, horizontal and front door adjustment

### Slider L70

Its features of reliability, modularity and capacity make L70 ideal for wardrobes in bedrooms and for all large cabinets in general. For large doors weighing up to 154 lbs.



- Max. weight per door 154 lbs.
- Soft closing with magnetic technology
- Width from 31-1/2" to 78-3/4"
- Max. height: 118-1/8"
- Thickness from 3/4" to 1-3/4" with handle
- Vertical, horizontal and front door adjustment.
- Available with a customisable front cover
- Pre-assembled mechanism for fast, safe assembly.



# CONCERTINA



## Concertina Doors

Designed to open both panels on one side only, giving good access to the interior of the cabinet.

4

Space taken up by the door in the maximum open position is reduced to a minimum (approximately 3-1/8" or 80mm). A nylon strip is available in order to prevent insertion of objects or fingers between doors. This also makes the system dustproof.

To ensure that the door closes fully and securely, particularly when there is some curvature of the door, a locating device is available.

**Components need to be ordered separately. For one door (2 panels) opening on one side only, please order:**



Two Salice hinges and plates will be needed for mounting on the fixed door/cabinet side. C2\_6A99 with the BAR3R plate is recommended. Examples below.



C2R6A99 x 2



BAR3R09 x 2

**F1C169 x 1 List \$ 10.72/ea.**

Hinge for the sliding block

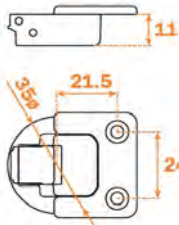

**F1CXE9 x 2-3 List \$ 4.31/ea.**

Central hinges,  
Screw-on

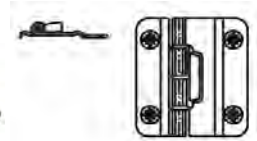

**F1PXAY x 1 List \$ 5.77/ea.**

Sliding block



**F1GFA11180 x 1 List \$ 21.85/ea.**

Track: screw on, 1180mm (46-7/16"), white in color

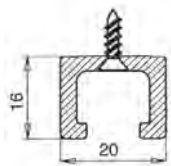

Check out videos on the Salice Concertina Door System here:  
[macpac1.com/videos.html#salice](http://macpac1.com/videos.html#salice)





# SALICE

## Concertina Doors Assembly Instructions

Application into the top of the cabinet and doors.  
Solution with plastic track barb-fixed or screw-fixed.

### Drilling distances without finger-protection strip.

To facilitate the assembly of the doors on the cabinet, it is preferable to premount all the hinges.

4

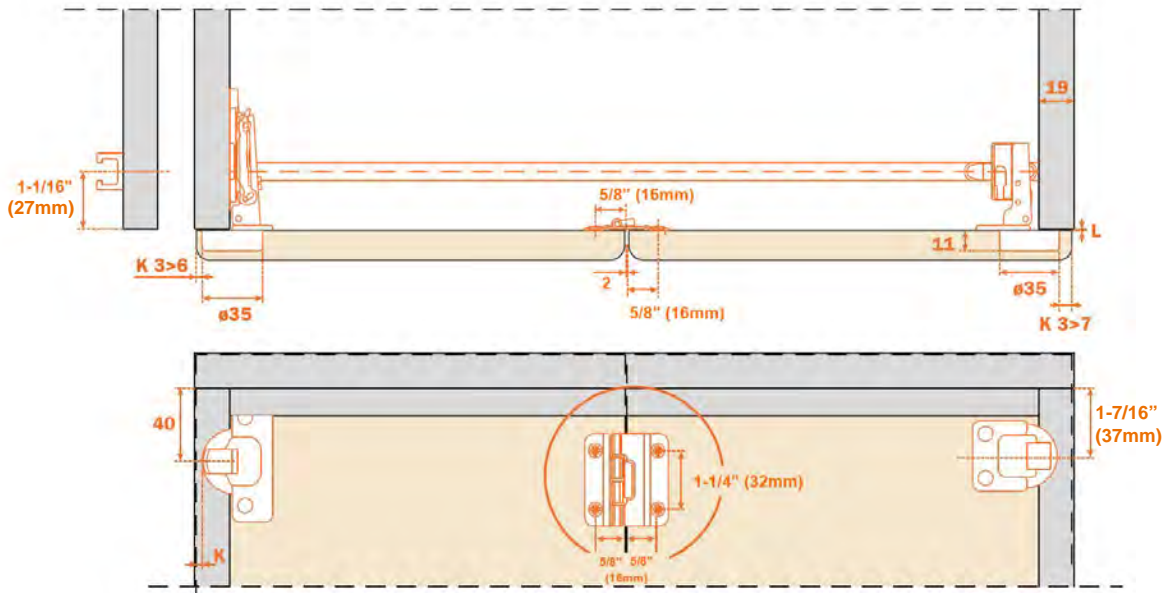

### Central assembly:

- narrow part to be mounted on the door which is fixed to the cabinet side;
- wider part to be mounted on the moving door.

Mount the hinges of the fixed door on to the mounting plates on the cabinet side.

We recommend the use of Salice hinge part number C2A6A99 110° with BAR3R mounting plate or similar.



Position the sliding block inside the track by rotating it 90°.

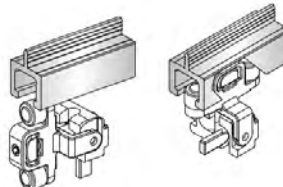

Lock the sliding block into position by turning the marked-in-orange lever.

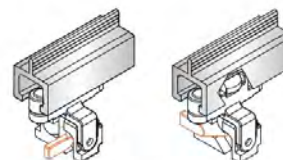



## EXEDRA



### Exedra Pocket Door System

Special Order

**Largely Pre-assembled,  
Custom Made to Order.**

Salice's pocket door system features an assisted soft-close door-return mechanism and a door opening safety device.

4

**This new soft close magnetic damper is directly attached to to the main track which provides a smoother soft close.**

The system incorporates an exclusive, synchronised cam movement – the hallmark of all sliding mechanisms supplied by Salice.

In addition, this system has been designed to offer simple fitting and adjustment, and can be installed, adjusted and inspected on site, as all three movements are adjusted from the front of the cabinet in a simple, intuitive way. If so required, the complete mechanism can be removed from the front without dismantling the cabinet side. For use with individual door weights up to 66 lbs.



#### Door Features

- Maximum weight for each door : 66 lbs (30 kg). (w/ 5 hinges allowed, distributed evenly)
- Thickness: - min. 3/4" (19 mm) - max. 1-3/16" (30 mm)
- Width: - min. 15-3/4" (400 mm) - max. 35-7/16" (900 mm)
- **Height: - min. 52-1/2" (1333 mm) - max. 99-5/8" (2530 mm)**
- Door vertical adjustment: +4/-1 mm
- Door horizontal adjustment: ±2 mm
- Door front adjustment: ±4 mm
- Cam-assisted door extraction movement
- Soft closing and soft opening buffer
- Material: a) wood or derivatives; b) metal and glass frame



**For a Price Quote, complete the order form found here:**

<https://macpac1.com/forms.html>

---





See Salice Pocket Door System videos at

<https://macpac1.com/videos.html#salice>

---

See Comparison to Hawa Concepta; unique features, pre-assembly, competitive pricing.

<https://macpac1.com/forms.html#Lit>

# SALICE

# EXEDRA2

## Exedra2 Pocket Door Systems: Star and Smart Special Order



Exedra2 Star and Exedra2 Smart enable the simultaneous movement of two linked doors. It is a patented mechanism with assisted door extraction and door insertion, operated by a magnetically-assisted motion-control system that confers a smooth and perfectly balanced movement. With a motion-control system, the handle can be fixed at the edges of the doors, allowing effortless opening and closing with one hand.

With the aid of the electric Push kit, it is possible to use both versions on handle-less furniture. The whole mechanism is self-supporting and fixed to the side of the cabinet; there are no load-bearing frontal profiles on either the top or bottom of the cabinet, thus eliminating any need for additional central supports. Can be used in a host of applications, from walk-in wardrobes to pantry units for kitchens, home office solutions and storage.

DOUBLE pocket door system with cam-assisted door extraction and cushioned door insertion.

### Adjustment:

- Vertical adjustment  $\pm 5\text{mm}$
- Horizontal adjustment  $\pm 3.5\text{mm}$
- Front adjustment:
  - upper  $\pm 3\text{mm}$
  - lower  $\pm 2\text{mm}$
- Maximum weight for single door: 55 lbs (25 Kg)
- Doors thickness: min 18mm - max 25mm
- Width of single door – Exedra2 Star: min 17-3/4" (450mm) - max 29-1/2" (750mm)
- Width of single door – Exedra2 Smart: min 21-5/8" (550mm) - max 33-7/16" (850mm)
- Doors height: min 70-7/8" (1800mm) - max 102-3/8" (2600mm)



### Exedra2 Star

Exedra2 Star is the version where the compartment that houses the mechanism is always hidden by the cover panel which is fixed to the front of the system.

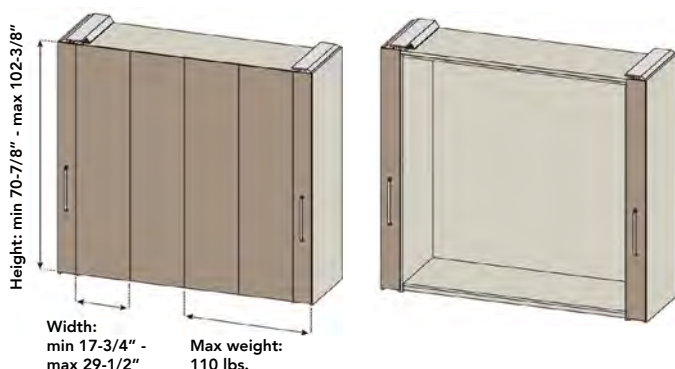

### Exedra2 Smart

Exedra2 Smart is the version that requires less depth of the cabinet; the door edges are visible when they are folded into their compartment.

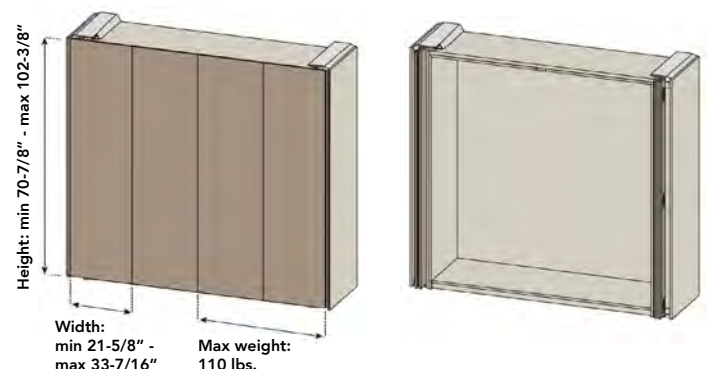



## SLIDING DOOR TRACK

### KV PACKAGED PLASTIC TRACK



4

Packaged set of low cost track for 1/8", 1/4", 1/2", or 3/4" doors. 10 set/carton.

Code	Description	List/ea
P2413T-4	48" Tan, 1/8" Doors	\$ 23.77
P2413T-6	72" " " "	32.13
P2417T-4	48" Tan, 1/4" Doors	22.85
P2417T-6	72" " " "	35.35
P2419T-4	48" Tan, 3/4" Doors	29.32
P2419T-6	72" " " "	40.44

### FIBRE TRACK & GLIDES

Fibre track and nylon glides for drawers and light weight sliding doors. Black in color.

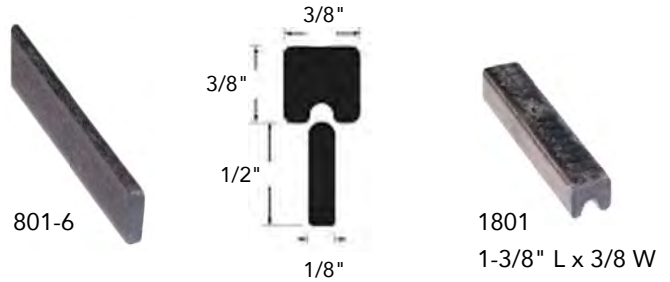

Code	Description	Ctn	List/ea
801-6	Track 1/8" x 1/2" x 6'	10 ea	\$ 22.91
1801	Nylon Glide, 1-3/8" long	10	3.02

### EXTRUDED GLASS/PANEL RETAINER

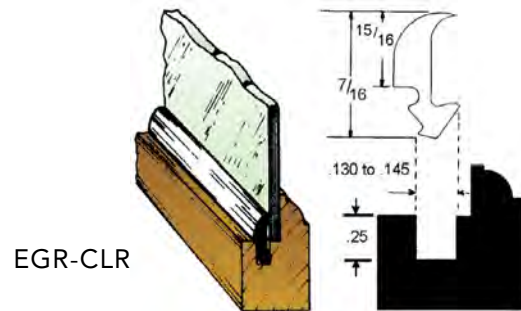

Clear, pliable plastic glass/panel retainer extrusion. Works well in cabinets with glass doors where back of door shows, and mirror-backed curios. 1000' per roll. Order by the foot.

Code	1'	100'	1000'
EGR-CLR	\$ 1.01/ft	\$ .64/ft	\$ .54/ft

Amana 3 Wing Slot Cutter with 3 Wing cutter, arbor & ball-bearing. 5/32" size also used for 'biscuit-joint' cutting.

Code	Kerf	Shank	List
53407 Slot Cutter	5/32"	1/4"	\$ 44.75
53407-1* Slot Cutter	5/32"	1/2"	44.75

\* Special Order



## SLIDING DOOR TRACK

### EPCO SLIDING DOOR TRACK

Polybagged with all Components and Installation Instructions.

#### For Wood & Glass Doors

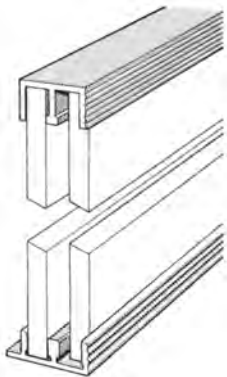

Extruded aluminum sliding door track and guide system for heavier 1/4" by-passing doors. Serrated face is designed to provide an attractive finished fascia. Screws included.

For Door Thickness: 1/4"  
Door Type: Wood/Glass  
Made of aluminum with a Mill Aluminum finish.

8-A-6

Code	Length	List/st
8-A-6	6'	\$ 108.58

#### For Wood Doors

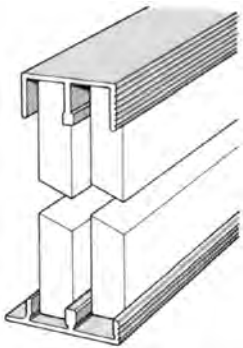

Extruded aluminum sliding door track and guide system for heavier 1/2" by-passing doors. Serrated face is designed to provide an attractive finished fascia. Button glides provide a smooth sliding action. Screws included.

Door Type: Wood  
Made of aluminum with a Mill Aluminum finish.

10-A-6, 11-A-6

Code	Length	Door Thickness	List/st
10-A-6	6'	1/2"	\$ 98.51
11-A-6	6'	3/4"	109.62

### KV P1092 - EZY ROLL ALUMINUM TRACK FOR SLIDING GLASS DOORS

Aluminum track assembly for sliding glass doors. Use on light, 1/4" glass doors. Consists of hardware for 1 pair of doors, overlapping 1". (Cut glass 1-1/4" less than opening vertically, allow for 1" overlap horizontally) Can be cut to size.

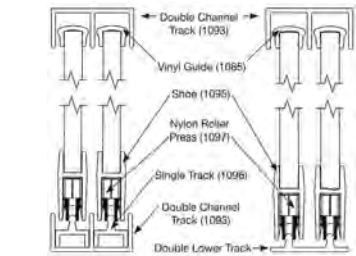
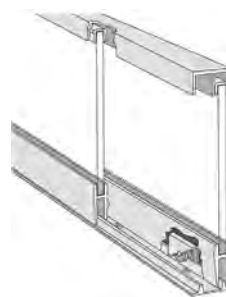

Recessed Mount

Surface Mount

Code	Description	List
P1092-3	Set with 36" Track Length	\$ 85.19/st
P1092-4	Set with 48" Track Length	99.62
P1092-5	Set with 60" Track Length	128.77
P1092-6	Set with 72" Track Length	147.06
1097KV	Spare Nylon Rollers	\$ 2.99/ea

### KV P992 - EZY ROLL BALL-BEARING TRACK FOR SLIDING GLASS DOORS

Ball-bearing track for sliding glass doors. Use on 1/4" glass doors. Consists of hardware for 1 pair of doors, overlapping 1". (Cut glass 1-1/4" less than opening vertically, allow for 1" overlap horizontally)



P992 Track Assembly

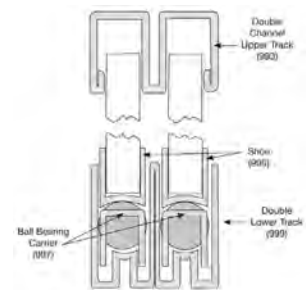

Cross Section

Code	Description	List
P992-3	Set with 36" Track Length	\$ 147.57/st
P992-4	Set with 48" Track Length	176.74
P992-5	Set with 60" Track Length	231.92
P992-6	Set with 72" Track Length	254.78



## SLIDING DOOR HARDWARE

### KV SLIDING DOOR TRACK

KV track is used with KV rollers and sheaves for sliding wood doors. Note sheave numbers used with each style.

4

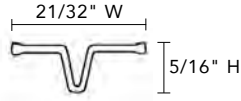

Code      List/ea  
455-12      \$ 66.61

KV 455 Single track for sliding doors. With ridge up use 427, 429, 430, and 594 sheaves. With ridge down use 592 sheave. Stainless Steel finish. 12' lengths. 10 ea/ctn.

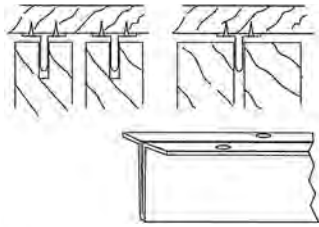

Code      List/ea  
953-12      \$ 64.51

KV 953 Upper guide. Separates 2 sliding doors or use as a top guide for a single door. Pre-coated Steel. 5/8" W x 5/8" H. 12' lengths. 8 ea/ctn.

### KV SLIDING DOOR SHEAVES



The 429 is a plain bearing sheave. The 427 & 430 are ball-bearing sheaves.

<u>Code</u>	<u>Wheel Dia.</u>	<u>Frame</u>	<u>Ctn</u>	<u>List/ea</u>
427KV	1-3/16"	2-15/16" x 1/2"	50	\$ 9.91
429	1"	2-1/4" x 3/8"	100	9.84
430KV	1-3/8"	2-3/4" x 1/2"	50	13.71



Code      Ctn      List/ea  
592KV      100      \$ 4.25\$

The 592 nylon sheave is for thin doors. Uses 455 track, inverted. 1-3/16" dia. roller. Frame: 9/32" x 2-1/4".



Code      Ctn      List/ea  
582      100      \$ 7.36

Use with 467 track. Enclosed nylon sheave roller for light doors. Case size: 1-1/4" x 5/16". Screw fastened. Flange 2-1/4" x 5/16".



Code      Ctn      List/ea  
607ZC      50      \$ 14.49

The 607 is a heavy duty sheave with a side fastening plate. Round groove, ball-bearing steel wheel. Zinc plated steel frame. Use with #455 & #467 track. Frame: 2-5/16" x 1-5/16", Wheel dia: 1-3/8".





## WIRE PULLS

### AMEROCK SOLID BRASS WIRE PULLS

BP865 - 3"  
BP76313 - 96mm  
Pack: 25 each per box



Code	C/C	Proj.	Finish	List/ea
BP865-26D	3"	1-1/4"	Dull Chrm	\$ 5.13
BP76313-26D	96mm	1-3/16"	Dull Chrm	4.94

### SUGATSUNE STAINLESS WIRE PULLS

Solid Stainless Steel,  
Satin Finish  
Projection: 1-5/16" (34mm)  
Dia: 5/16" (8mm)



Code	Length	C/C	Ctn	List/ea
SWP-6355	3-13/16"	3-1/2"	20 ea.	\$ 7.18
SWP-6405	4-5/16"	4"	20	9.00

### SUGATSUNE STAINLESS STEEL PULL

Solid Stainless Steel,  
Satin Finish. With Screws.  
Projection: 15/16" (23mm)



Code	Length	C/C	Ctn	List/ea
DDS90S	3-9/16"	3-11/32"	20 ea.	\$ 13.09

### PLASTIC WIRE PULLS

96mm (3.77") C/C,  
O.D. = 25/64"  
O/A Length: 4-1/8"  
Projection: 1-1/4"

Pack: 100 each

Code	Description	List/ea
1524WH	96mm C/C, White	\$.60



### STEEL WIRE PULLS

Pack: 250 per box  
Projection: 1-3/16"  
Dia: 5/16"



Code	C/C	Finish	List/ea
P353-PB	3"	Polished Brass	\$ 1.49
P353-PC	3"	Polished Chrome	1.49
P353-SC	3"	Satin Chrome	2.11
P353-BL	3"	Matte Black	2.05
P353-10B	3"	Oil Rubbed Bronze	1.69
P354-PB	3.5"	Polished Brass	1.84
P354-PC	3.5"	Polished Chrome	1.58
P354-SC	3.5"	Satin Chrome	1.90
P354-10B	3.5"	Oil Rubbed Bronze	2.00
P355-PB	4"	Polished Brass	1.82
P355-PC	4"	Polished Chrome	2.02
P355-SC	4"	Satin Chrome	2.22
P355-10B	4"	Oil Rubbed Bronze	2.82
P355-BK	4"	Matte Black	3.10
P355-SS	4"	Stainless Steel	7.49
P356-SS	5"	Stainless Steel	7.52
P396-PB	96mm	Polished Brass	1.65
P396-PC	96mm	Polished Chrome	2.16
P396-SC	96mm	Satin Chrome	2.18
P396-BL	96mm	Matte Black	2.58
P396-10B	96mm	Oil Rubbed Bronze	2.00
P396-SS	96mm	Stainless Steel	4.17

### EPCO ALUMINUM WIRE PULL

Gloss White Powder Coat finish

O.D. = 5/16",  
Projection = 1-5/16"



Code	Description	List/ea
MC402-3.5-WH	3-1/2" C/C, White pull	\$ 8.99
MC402-4-WH	4" C/C, White pull	9.13



## BAR PULLS

### AMEROCK STAINLESS STEEL BAR PULLS



5

Solid Stainless Steel Bar Pulls have clean, sleek lines. Lengths 6" to 33" available. The stainless steel look blends well with both light and dark finishes.

Code	C/C	Overall Length	Ctn	List/ea
BP19010-SS	3"	5-3/8"	20	\$ 12.92
BP19011-SS	3-3/4"	6-1/8"	20	15.96
BP19541-SS	5-1/16"	7-3/8"	25	17.83
BP19012-SS	7-9/16"	9-15/16"	20	20.80
BP19013-SS	10-1/16"	13-1/4"	10	20.08
BP19014-SS	12-5/8"	15-3/4"	10	22.11
BP19015-SS	16-3/8"	19-1/2"	10	25.34
BP19016-SS	18-7/8"	22-1/16"	10	27.62
BP19017-SS	21-7/16"	24.57"	10	34.01
BP19018-SS	25-3/16"	28.35"	5	40.02
BP19019-SS	30-1/4"	33.39"	5	41.62

#### Carbon Steel\*

BP19541CS-G9	5-1/16"	7-3/8"	25	\$ 14.49
BP19012CS-G9	7-9/16"	9-15/16"	20	15.03

\*while supplies last

### AMEROCK BAR PULLS - Oil Rubbed Bronze



All in Oil Rubbed Bronze Finish.

Code	Description	List/ea
BP40515-ORB	Bar Pull, 3" C/C	\$ 11.50
BP40516-ORB	Bar Pull, 96mm C/C (3.78")	14.16
BP40517-ORB	Bar Pull, 128mm C/C (5.04")	17.46
BP40518-ORB	Bar Pull, 192mm C/C (7.56")	17.23
BP40519-ORB	Bar Pull, 256mm C/C (10.08")	20.12

### SUGATSUNE SOLID STAINLESS STEEL BAR PULLS

Satin Stainless Steel. Supplied with screws.

Pack: 25 each

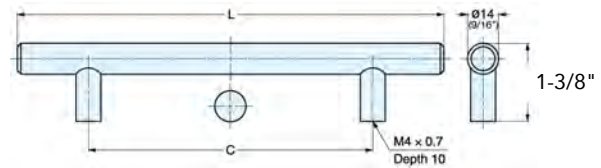

Code	L	C (to C)	List/ea
2647	7-9/16"	5-1/32"	\$ 17.89

### SUGATSUNE SOLID STAINLESS STEEL PULLS

Special Order

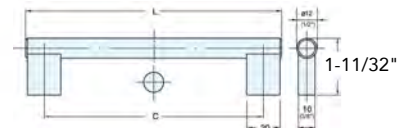

Satin Stainless Steel. Supplied with screws.

Pack: 25 each

Code	L	C	List/ea
1646*	4-5/8"	3-25/32"	\$ 20.95
1647*	5-15/16"	5-1/32"	21.96
1648*	7-3/16"	6-5/16"	22.60
1650*	8-7/16"	7-9/16"	24.50
1651*	12-3/8"	11-7/16"	27.60
1652*	13-7/16"	12-9/16"	29.00
1653*	14-5/16"	13-7/16"	31.00
1654*	16-5/16"	15-7/16"	35.20
1655*	20-1/4"	19-3/8"	37.10
1656*	24-3/16"	23-5/16"	40.60

\* Special Order

## KNOBS & PULLS

### SUGATSUNE CABINET KNOB

Solid Brass

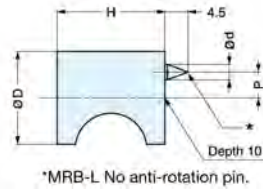

Pack: 30 each, with screws.

Code	Finish	Dia.	Ht.	List/ea
MRBS-SN	Satin Nickel	11/16"	7/8"	\$ 8.90
MRBL-CR	Pol. Chrome	15/16"	7/8"	9.91
MRBL-SN	Satin Nickel	15/16"	7/8"	14.15

### STEEL ARCHITECTURAL PULLS



Pack: 25 ea.

Code	C/C	Finish	List/ea
3986-96SN	96mm (3-25/32")	Sat. Nickel	\$ 6.67
3986-96SC	96mm (3-25/32")	Sat. Chrome	7.36
3986-96MB	96mm (3-25/32")	Matte Black	7.16
3986-128SN	128mm (5-3/64")	Sat. Nickel	9.96
3986-128MB	128mm (5-3/64")	Matte Black	6.85
3986-128SC	128mm (5-3/64")	Sat. Chrome	7.10
3986-128PC	128mm (5-3/64")	Pol. Chrome	5.22

### AMEROCK STAINLESS STEEL PULLS & KNOBS

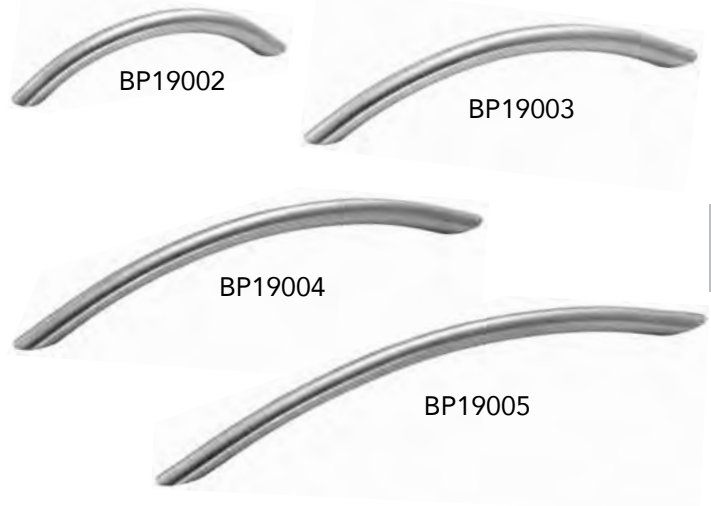

Code	Dimensions	Ctn	List/ea
BP19002-SS	Pull, 96mm CC, 4-9/16" L	20	\$ 11.52
BP19003-SS	Pull, 128mm CC, 6" L	20	20.39
BP19004-SS	Pull, 160mm CC, 7-1/2" L	20	25.54
BP19005-SS	Pull, 192mm CC, 9" L	20	22.99
BP19008-SS	Knob, 1-1/4" Dia	10	21.53
BP19009-SS	T-Knob, 1-15/16" L, SS	10	15.59
BP19010-SS	Bar Pull, 3" CC, 5-3/8" L, SS	20	12.92

### KNOBS

Zinc  
Material



3915-SN  
1" Dia.

Pack: 50 each

Code	Description	List/ea
3915-SN	Knob, 1" Dia, Satin Nickel	\$ 2.67

## BAR PULLS

**PRIDE**

### BAR PULLS

P104-SN Pack: 25 each.  
 P107-SS Pack: 20 each.  
 All others Pack: 10 each.

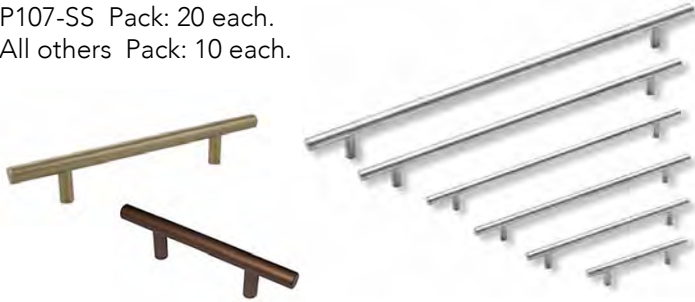

Code	Size	Finish	List/ea
P104-SN	115mm OL x 64mm C/C	Sat Nickel	\$ 5.23
P105-SS	5-1/2" OL x 3" C/C	St Steel	13.29
P106-10B	6" OL x 3" C/C	Oil R Brz	6.99
P106-BK	6" OL x 3" C/C	Matte Blk	4.96
P106-PC	6" OL x 3" C/C	Pol Chrome	7.41
P106-RG	6" OL x 3" C/C	Rose Gold	8.15
P106-SN	6" OL x 3" C/C	Sat Nickel	6.48
P1096-10B	6" OL x 96mm C/C	Oil R Brz	7.06
P1096-BK	6" OL x 96mm C/C	Matte Blk	7.83
P1096-DP	6" OL x 96mm C/C	Dk Pewter	6.62
P1096-PC	6" OL x 96mm C/C	Pol Chrome	7.92
P1096-RG	6" OL x 96mm C/C	Rose Gold	10.05
P1096-SN	6" OL x 96mm C/C	Sat Nickel	10.36
P107-SS	7" OL x 128mm C/C	St Steel	20.73
P107-SN	7" OL x 128mm C/C	Sat Nickel	8.57
P108-10B	8" OL x 5" C/C	Oil R Brz	9.86
P108-BK	8" OL x 5" C/C	Matte Blk	9.62
P108-DP	8" OL x 5" C/C	Dk Pewter	7.21
P108-PC	8" OL x 5" C/C	Pol Chrome	10.05
P108-RG	8" OL x 5" C/C	Rose Gold	12.04
P108-SN	8" OL x 5" C/C	Sat Nickel	8.41
P110-10B	10" OL x 7" C/C	Oil R Brz	8.70
P110-BK	10" OL x 7" C/C	Matte Blk	12.72
P110-DP	10" OL x 7" C/C	Dk Pewter	8.92
P110-RG	10" OL x 7" C/C	Rose Gold	12.83
P110-SN	10" OL x 7" C/C	Sat Nickel	8.89

### BAR PULLS cont.

Code	Size	Finish	List/ea
P112-10B	12" OL x 9" C/C	Oil R Brz	\$ 10.49
P112-BK	12" OL x 9" C/C	Matte Blk	13.16
P112-RG	12" OL x 9" C/C	Rose Gold	12.90
P112-SN	12" OL x 9" C/C	Sat Nickel	12.29
P114-BK	14" OL x 11" C/C	Matte Blk	14.29
P114-RG	14" OL x 11" C/C	Rose Gold	10.98
P114-SN	14" OL x 11" C/C	Sat Nickel	13.83
P116-10B	16" OL x 13" C/C	Oil R Brz	12.98
P116-RG	16" OL x 13" C/C	Rose Gold	12.98
P116-SN	16" OL x 13" C/C	Sat Nickel	12.67
P118-SN	18" OL x 15" C/C	Sat Nickel	15.09
P120-SN	20" OL x 17" C/C	Sat Nickel	17.50
P122-SN	22" OL x 19" C/C	Sat Nickel	19.06
P124-SN	24" OL x 21" C/C	Sat Nickel	14.99
P126-SN	26" OL x 23" C/C	Sat Nickel	20.15
P128-SN	28" OL x 25" C/C	Sat Nickel	24.32
P130-SN	30" OL x 27" C/C	Sat Nickel	18.97

### Bar Pull Knob 2" L x 12mm Dia.



Code	Finish	Ctn	List/ea
K102-SN	Satin Nickel	50	\$ 4.02
K102-10B	Oil R Bronze	25	3.44

### Eleganza Bar Pulls



Code	C/C	Finish	Ctn	List/ea
P72276-SN	96mm	Satin Nickel	20	\$ 8.78
P72277-SN	128mm	Satin Nickel	20	10.28
P72278-SN	192mm	Satin Nickel	20	7.07

### Pride Finishes





**PRIDE**

**KNOBS & PULLS**

**MODERN COLLECTION KNOBS AND PULLS**

**Modern Square Pulls**

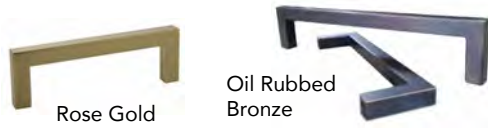

Code	C/C	Finish	Ctn	List/ea
P87226-10B	96mm	Oil R Bronze	25	\$ 9.28
P87226-BK	96mm	Matte Black	25	10.11
P87226-DP	96mm	Dark Pewter	25	9.78
P87226-PC	96mm	Pol Chrome	25	9.96
P87226-RG	96mm	Rose Gold	25	10.54
P87226-SN	96mm	Satin Nickel	25	8.25
P87227-10B	128mm	Oil R Bronze	20	11.59
P87227-BK	128mm	Matte Black	20	13.88
P87227-DP	128mm	Dark Pewter	20	10.65
P87227-PC	128mm	Pol Chrome	20	10.32
P87227-RG	128mm	Rose Gold	20	14.84
P87227-SN	128mm	Satin Nickel	20	9.70
P87228-10B	160mm	Oil R Bronze	25	11.73
P87228-BK	160mm	Matte Black	25	15.53
P87228-DP	160mm	Dark Pewter	25	13.13
P87228-PC	160mm	Pol Chrome	25	13.02
P87228-RG	160mm	Rose Gold	25	19.78
P87228-SN	160mm	Satin Nickel	25	11.94
P87229-10B	192mm	Oil R Bronze	25	15.19
P87229-BK	192mm	Matte Black	25	15.77
P87229-DP	192mm	Dark Pewter	25	15.22
P87229-PC	192mm	Pol Chrome	25	15.79
P87229-RG	192mm	Rose Gold	25	23.19
P87229-SN	192mm	Satin Nickel	25	16.13
P87300-10B	224mm	Oil R Bronze	10	17.98
P87300-BK	224mm	Matte Black	10	17.21
P87300-SN	224mm	Satin Nickel	10	17.43

**Square 1" Knobs**



Code	Finish	Ctn	List/ea
K83125-10B	Oil R Bronze	25	\$ 5.86
K83125-BK	Matte Black	25	6.64
K83125-DP	Dark Pewter	25	5.20
K83125-PC	Polished Chrome	25	5.32
K83125-RG	Rose Gold	25	6.04
K83125-SN	Satin Nickel	25	6.09

**Bar Knob  
32mm C/C x 48mm L**

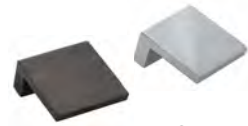

Code	Finish	Ctn	List/ea
K1667-10B	Oil R Bronze	25	\$ 6.72
K1667-PC	Pol Chrome	25	5.66
K1667-SN	Satin Nickel	25	5.81

**Modern Pulls**



Code	C/C	Finish	Ctn	List/ea
P81456-10B	96mm	Oil R Bronze	20	\$ 9.01
P81456-BK	96mm	Matte Black	20	10.00
P81456-PC	96mm	Pol Chrome	20	8.51
P81456-RG	96mm	Rose Gold	20	9.45
P81456-SN	96mm	Satin Nickel	20	8.04
P81458-10B	128mm	Oil R Bronze	25	8.42
P81458-BK	128mm	Matte Black	25	8.42
P81458-PC	128mm	Pol Chrome	25	8.94
P81458-RG	128mm	Rose Gold	25	10.02
P81458-SN	128mm	Satin Nickel	25	8.22

**Modern Pulls**



Code	C/C	Finish	Ctn	List/ea
P82234-10B	96mm	Oil R Bronze	25	\$ 5.83
P82234-BK	96mm	Matte Black	25	5.49
P82234-PC	96mm	Pol Chrome	25	5.65
P82234-SN	96mm	Satin Nickel	25	6.11
P82034-10B	128mm	Oil R Bronze	25	4.99
P82034-BK	128mm	Matte Black	25	5.25
P82034-PC	128mm	Pol Chrome	25	6.16
P82034-SN	128mm	Satin Nickel	25	6.71
P81235-10B	160mm	Oil R Bronze	25	9.19
P81235-BK	160mm	Matte Black	25	8.10
P81235-PC	160mm	Pol Chrome	25	8.10
P81235-SN	160mm	Satin Nickel	25	9.57



## KNOBS & PULLS

## PRIDE

### St. Louis Arch Pulls



Code	C/C	Finish	Ctn	List/ea
P91496-10B	96mm	Oil R Bronze	25	\$ 13.06
P91496-SN	96mm	Satin Nickel	25	13.67
P91497-10B	128mm	Oil R Bronze	25	16.52
P91497-SN	128mm	Satin Nickel	25	16.66
P91498-10B	160mm	Oil R Bronze	25	19.16
P91498-SN	160mm	Satin Nickel	25	21.02

### St. Louis Mushroom Knobs



Code	Dia	Finish	Ctn	List/ea
K81361-10B	1-1/8"	Oil R Bronze	25	\$ 5.13
K81361-BK	1-1/8"	Matte Black	25	4.86
K81361-PC	1-1/8"	Pol Chrome	25	5.08
K81361-RG	1-1/8"	Rose Gold	25	5.44
K81361-SN	1-1/8"	Satin Nickel	25	5.19

### Washington Pulls



Code	C/C	Finish	Ctn	List/ea
P91296-10B	96mm	Oil R Bronze	25	\$ 14.65
P91296-RG	96mm	Rose Gold	25	15.45
P91296-SN	96mm	Satin Nickel	25	11.79
P91297-10B	128mm	Oil R Bronze	25	17.38
P91297-RG	128mm	Rose Gold	25	18.34
P91297-SN	128mm	Satin Nickel	25	14.82
P91298-10B	160mm	Oil R Bronze	25	21.17
P91298-RG	160mm	Rose Gold	25	17.84
P91298-SN	160mm	Satin Nickel	25	18.75

### Washington 33.6mm x 25mm Knobs



Code	Finish	Ctn	List/ea
K91090-10B	Oil R Bronze	25	\$ 12.90
K91090-RG	Rose Gold	25	13.45
K91090-SN	Satin Nickel	25	12.90

### Colorado Pulls



Code	C/C	Finish	Ctn	List/ea
P92836-10B	96mm	Oil R Bronze	15	\$ 11.07
P92836-BK	96mm	Matte Black	15	10.17
P92836-DP	96mm	Dk Pewter	15	11.10
P92836-PC	96mm	Pol Chrome	15	8.29
P92836-RG	96mm	Rose Gold	15	11.76
P92836-SN	96mm	Satin Nickel	15	10.09
P92837-10B	128mm	Oil R Bronze	10	12.92
P92837-BK	128mm	Matte Black	10	10.78
P92837-DP	128mm	Dk Pewter	10	13.01
P92837-PC	128mm	Pol Chrome	10	9.81
P92837-RG	128mm	Rose Gold	10	12.50
P92837-SN	128mm	Satin Nickel	10	13.25
P92838-10B	160mm	Oil R Bronze	10	12.64
P92838-BK	160mm	Matte Black	10	14.93
P92838-DP	160mm	Dk Pewter	10	15.04
P92838-PC	160mm	Pol Chrome	10	12.13
P92838-RG	160mm	Rose Gold	10	16.68
P92838-SN	160mm	Satin Nickel	10	15.42

### Colorado Knobs 29mm Square



Code	Square	Finish	Ctn	List/ea
K94723-10B	29mm	Oil R Bronze	20	\$ 7.08
K94723-BK	29mm	Matte Black	20	5.22
K94723-DP	29mm	Dk Pewter	20	6.98
K94723-PC	29mm	Pol Chrome	20	5.58
K94723-RG	29mm	Rose Gold	20	7.51
K94723-SN	29mm	Satin Nickel	20	7.22

### Modern Bow Pulls 128mm C/C



Code	C/C	Finish	Ctn	List/ea
P82104-SN	128mm	Satin Nickel	25	\$ 6.87



## PRIDE

## KNOBS & PULLS

### Colorado Knobs 32mm Diameter



Code	Dia	Finish	Ctn	List/ea
K92925-10B	32mm	Oil R Bronze	25	\$ 5.16
K92925-BK	32mm	Matte Black	25	5.90
K92925-DP	32mm	Dk Pewter	25	6.61
K92925-PC	32mm	Pol Chrome	25	5.66
K92925-RG	32mm	Rose Gold	25	7.44
K92925-SN	32mm	Satin Nickel	25	6.74

### Vail Pulls



Code	C/C	Finish	Ctn	List/ea
P86373-10B	96mm	Oil R Bronze	25	\$ 5.66
P86373-BK	96mm	Matte Black	25	6.32
P86373-DP	96mm	Dk Pewter	25	8.22
P86373-PC	96mm	Pol Chrome	25	5.51
P86373-RG	96mm	Rose Gold	25	7.57
P86373-SN	96mm	Satin Nickel	25	6.07
P86374-10B	128mm	Oil R Bronze	25	9.83
P86374-BK	128mm	Matte Black	25	7.03
P86374-DP	128mm	Dk Pewter	25	9.05
P86374-PC	128mm	Pol Chrome	25	9.57
P86374-RG	128mm	Rose Gold	25	11.38
P86374-SN	128mm	Satin Nickel	25	10.40
P86375-10B	160mm	Oil R Bronze	10	12.91
P86375-BK	160mm	Matte Black	10	11.52
P86375-DP	160mm	Dk Pewter	10	15.27
P86375-PC	160mm	Pol Chrome	10	10.72
P86375-RG	160mm	Rose Gold	10	13.60
P86375-SN	160mm	Satin Nickel	10	14.14

### Vail Knobs



Code	Dia	Finish	Ctn	List/ea
K1218-10B	32mm	Oil R Bronze	25	\$ 6.31
K1218-BK	32mm	Matte Black	25	6.99
K1218-DP	32mm	Dk Pewter	25	8.10
K1218-PC	32mm	Pol Chrome	25	7.36
K1218-RG	32mm	Rose Gold	25	8.07
K1218-SN	32mm	Satin Nickel	25	7.64

### Charlotte Deco Pulls



Code	C/C	Finish	Ctn	List/ea
P81092-10B	96mm	Oil R Bronze	25	\$ 7.69
P81092-BK	96mm	Matte Black	25	5.84
P81092-PC	96mm	Pol Chrome	25	5.63
P81092-RG	96mm	Rose Gold	25	7.74
P81092-SN	96mm	Satin Nickel	25	5.07
P82092-10B	128mm	Oil R Bronze	25	5.76
P82092-BK	128mm	Matte Black	25	10.62
P82092-PC	128mm	Pol Chrome	25	6.83
P82092-RG	128mm	Rose Gold	25	6.91
P82092-SN	128mm	Satin Nickel	25	7.34
P83092-10B	160mm	Oil R Bronze	20	8.95
P83092-BK	160mm	Matte Black	20	11.42
P83092-PC	160mm	Pol Chrome	20	10.37
P83092-RG	160mm	Rose Gold	20	14.52
P83092-SN	160mm	Satin Nickel	20	14.10

### Charlotte Knobs 32mm Square



Code	Square	Finish	Ctn	List/ea
K81091-10B	32mm	Oil R Bronze	25	\$ 6.32
K81091-BK	32mm	Matte Black	25	6.44
K81091-PC	32mm	Pol Chrome	25	5.06
K81091-RG	32mm	Rose Gold	25	6.48
K81091-SN	32mm	Satin Nickel	25	6.06

### Pyramid Knobs 32mm Square



Code	Square	Finish	Ctn	List/ea
K53082-10B	32mm	Oil R Bronze	25	\$ 6.44
K53082-PC	32mm	Pol Chrome	25	5.21
K53082-SN	32mm	Satin Nickel	25	6.17



## KNOBS & PULLS

## PRIDE

### Florence Knobs



Code	Square	Finish	Ctn	List/ea
K93002-10B	39mm	Oil R Bronze	25	\$ 10.81
K93002-BK	39mm	Matte Black	25	9.92
K93002-DP	39mm	Dk Pewter	25	10.81
K93002-PC	39mm	Pol Chrome	25	10.43
K93002-RG	39mm	Rose Gold	25	11.72
K93002-SN	39mm	Satin Nickel	25	11.20

### Colonial Knobs



Code	Finish	Dia	List/ea
K971-BK	Matte Black	1-3/8"	\$ 5.16
K971-RG	Rose Gold	1-3/8"	5.71

### Modern Pulls

Overall Length: 5-3/4"



Code	C/C	Finish	Ctn	List/ea
P21768-10B	128mm	Oil R Bronze	25	\$ 7.63
P21768-RG	128mm	Rose Gold	25	8.24
P21768-SN	128mm	Sat Nickel	25	6.82

### Round Knobs



Code	Dia	Finish	Ctn	List/ea
K910H-SN	30mm	Satin Nickel	100	\$ 2.46
K910-DP	30	Dark Pewter	25	3.25
K910-RG	30	Rose Gold	25	3.64
K910-BK	30	Matte Black	25	3.64

### Madison Pulls



Code	C/C	Finish	Ctn	List/ea
P93096-10B	96mm	Oil R Bronze	25	\$ 7.84
P93096-BK	96mm	Matte Black	25	7.00
P93096-DP	96mm	Dk Pewter	25	7.32
P93096-PC	96mm	Pol Chrome	25	7.41
P93096-RG	96mm	Rose Gold	25	7.08
P93096-SN	96mm	Satin Nickel	25	8.09
P93128-10B	128mm	Oil R Bronze	25	9.19
P93128-BK	128mm	Matte Black	25	8.24
P93128-DP	128mm	Dk Pewter	25	9.19
P93128-PC	128mm	Pol Chrome	25	7.24
P93128-RG	128mm	Rose Gold	25	9.87
P93128-SN	128mm	Satin Nickel	25	8.48
P93160-10B	160mm	Oil R Bronze	20	9.22
P93160-BK	160mm	Matte Black	20	9.71
P93160-DP	160mm	Dk Pewter	20	10.97
P93160-PC	160mm	Pol Chrome	20	8.65
P93160-RG	160mm	Rose Gold	20	11.65
P93160-SN	160mm	Satin Nickel	20	11.16

### Madison Knobs 28mm Square



Code	Square	Finish	Ctn	List/ea
K92230-10B	28mm	Oil R Bronze	25	\$ 4.33
K92230-BK	28mm	Matte Black	25	3.90
K92230-DP	28mm	Dk Pewter	25	3.52
K92230-PC	28mm	Pol Chrome	25	3.79
K92230-RG	28mm	Rose Gold	25	4.67
K92230-SN	28mm	Satin Nickel	25	4.47

### Madison Knobs 36mm x 28mm Rectangular



Code	L x W	Finish	Ctn	List/ea
K92430-10B	36mm x 28mm	Oil R Bronze	25	\$ 4.57
K92430-BK	36mm x 28mm	Matte Black	25	4.76
K92430-DP	36mm x 28mm	Dk Pewter	25	5.30
K92430-PC	36mm x 28mm	Pol Chrome	25	5.06
K92430-RG	36mm x 28mm	Rose Gold	25	5.77
K92430-SN	36mm x 28mm	Satin Nickel	25	5.53





### PRIDE

### KNOBS & PULLS

#### Milan Pulls



Code	C/C	Finish	Ctn	List/ea
P94096-10B	96mm	Oil R Bronze	20	\$ 7.16
P94096-BK	96mm	Matte Black	20	7.51
P94096-DP	96mm	Dk Pewter	20	7.00
P94096-PC	96mm	Pol Chrome	20	7.85
P94096-RG	96mm	Rose Gold	20	8.95
P94096-SN	96mm	Satin Nickel	20	7.99
P94128-10B	128mm	Oil R Bronze	20	9.02
P94128-BK	128mm	Matte Black	20	7.93
P94128-DP	128mm	Dk Pewter	20	8.74
P94128-PC	128mm	Pol Chrome	20	9.75
P94128-RG	128mm	Rose Gold	20	11.16
P94128-SN	128mm	Satin Nickel	20	9.02
P94160-10B	160mm	Oil R Bronze	20	12.85
P94160-BK	160mm	Matte Black	20	9.58
P94160-DP	160mm	Dk Pewter	20	10.43
P94160-PC	160mm	Pol Chrome	20	9.87
P94160-RG	160mm	Rose Gold	20	13.38
P94160-SN	160mm	Satin Nickel	20	12.85
P94210-10B	210mm	Oil R Bronze	25	13.02
P94210-BK	210mm	Matte Black	25	12.33
P94210-DP	210mm	Dk Pewter	25	12.58
P94210-PC	210mm	Pol Chrome	25	11.93
P94210-RG	210mm	Rose Gold	25	15.08
P94210-SN	210mm	Satin Nickel	25	13.02

#### Deco Bow Pulls



Code	C/C	Finish	Ctn	List/ea
P81541-10B	96mm	Oil R Bronze	25	\$ 6.84
P81541-PC	96mm	Pol Chrome	25	6.88
P81541-SN	96mm	Satin Nickel	25	6.44

#### Contemporary Pulls



Code	C/C	Finish	Ctn	List/ea
P888-SN	128mm	Satin Nickel	25	\$ 6.20

#### Monaco Pulls



Code	C/C	Finish	Ctn	List/ea
P96096-10B	96mm	Oil R Bronze	25	\$ 35.32
P96096-BK	96mm	Matte Black	25	32.82
P96096-DP	96mm	Dk Pewter	25	34.79
P96096-PC	96mm	Pol Chrome	25	33.35
P96096-RG	96mm	Rose Gold	25	30.90
P96096-SN	96mm	Satin Nickel	25	29.68
P96128-10B	128mm	Oil R Bronze	10	40.57
P96128-BK	128mm	Matte Black	10	31.50
P96128-DP	128mm	Dk Pewter	10	33.48
P96128-PC	128mm	Pol Chrome	10	32.11
P96128-RG	128mm	Rose Gold	10	42.16
P96128-SN	128mm	Satin Nickel	10	34.09
P96160-10B	160mm	Oil R Bronze	10	39.39
P96160-BK	160mm	Matte Black	10	36.36
P96160-DP	160mm	Dk Pewter	10	38.46
P96160-PC	160mm	Pol Chrome	10	36.96
P96160-RG	160mm	Rose Gold	10	40.88
P96160-SN	160mm	Satin Nickel	10	39.39

#### Monaco Knobs 45mm Square



Code	Square	Finish	Ctn	List/ea
K93122-10B	45mm	Oil R Bronze	10	\$ 18.57
K93122-BK	45mm	Matte Black	10	14.40
K93122-DP	45mm	Dk Pewter	10	15.61
K93122-PC	45mm	Pol Chrome	10	15.00
K93122-RG	45mm	Rose Gold	10	19.63
K93122-SN	45mm	Satin Nickel	10	15.89

#### Deco Knobs & Pulls

Ctn: 25/ea.



Code	Description	Finish	List/ea
K86618-RG	Knob, 18 x 65mm	Rose Gold	\$ 6.47
P86718-RG	Pull, 128mm C/C	Rose Gold	9.50

**KNOBS & PULLS****PRIDE****Miami Pulls**

<u>Code</u>	<u>C/C</u>	<u>Finish</u>	<u>Ctn</u>	<u>List/ea</u>
P80572-10B	96mm	Oil R Bronze	25	\$ 6.98
P80572-BK	96mm	Matte Black	25	5.59
P80572-DP	96mm	Dk Pewter	25	7.20
P80572-PC	96mm	Pol Chrome	25	6.33
P80572-RG	96mm	Rose Gold	25	8.96
P80572-SN	96mm	Satin Nickel	25	6.65
P81572-BK	128mm	Matte Black	25	7.39
P81572-DP	128mm	Dk Pewter	25	8.37
P81572-PC	128mm	Pol Chrome	25	7.46
P81572-RG	128mm	Rose Gold	25	10.51
P81572-SN	128mm	Satin Nickel	25	7.45
P83572-BK	160mm	Matte Black	25	9.06
P83572-DP	160mm	Dk Pewter	25	10.93
P83572-PC	160mm	Pol Chrome	25	7.37
P83572-RG	160mm	Rose Gold	25	13.75
P83572-SN	160mm	Satin Nickel	25	9.62

**Craftsman Pulls**

<u>Code</u>	<u>C/C</u>	<u>Finish</u>	<u>Ctn</u>	<u>List/ea</u>
P81929-10B	128mm	Oil R Bronze	10	\$ 14.22
P81929-APH	128mm	Satin Pewter	10	14.20
P81929-SN	128mm	Satin Nickel	10	12.66

**Craftsman 32mm Square Knobs**

<u>Code</u>	<u>Square</u>	<u>Finish</u>	<u>Ctn</u>	<u>List/ea</u>
K82929-APH	45mm	Satin Pewter	25	\$ 6.26
K82929-SN	45mm	Satin Nickel	25	6.27

**Manhattan Pulls**

<u>Code</u>	<u>C/C</u>	<u>Finish</u>	<u>Ctn</u>	<u>List/ea</u>
P92926-10B	96mm	Oil R Bronze	15	\$ 7.99
P92926-BK	96mm	Matte Black	15	9.39
P92926-DP	96mm	Dk Pewter	15	10.81
P92926-PC	96mm	Pol Chrome	15	9.84
P92926-RG	96mm	Rose Gold	15	11.07
P92926-SN	96mm	Satin Nickel	15	10.43
P92927-10B	128mm	Oil R Bronze	10	12.23
P92927-BK	128mm	Matte Black	10	11.07
P92927-DP	128mm	Dk Pewter	10	12.20
P92927-PC	128mm	Pol Chrome	10	10.92
P92927-RG	128mm	Rose Gold	10	13.23
P92927-SN	128mm	Satin Nickel	10	12.47
P92928-10B	160mm	Oil R Bronze	10	15.01
P92928-BK	160mm	Matte Black	10	12.26
P92928-DP	160mm	Dk Pewter	10	14.97
P92928-PC	160mm	Pol Chrome	10	12.79
P92928-RG	160mm	Rose Gold	10	16.22
P92928-SN	160mm	Satin Nickel	10	15.20

**Deco Pulls**

<u>Code</u>	<u>C/C</u>	<u>Finish</u>	<u>Ctn</u>	<u>List/ea</u>
P87215-10B	96mm	Oil R Bronze	25	\$ 4.82
P87215-BK	96mm	Matte Black	25	5.65
P87215-PC	96mm	Pol Chrome	25	4.30
P87215-SN	96mm	Satin Nickel	25	4.40
P87216-10B	128mm	Oil R Bronze	25	5.31
P87216-BK	128mm	Matte Black	25	6.47
P87216-PC	128mm	Pol Chrome	25	4.75
P87216-SN	128mm	Satin Nickel	25	4.92
P87218-10B	160mm	Oil R Bronze	10	7.78
P87218-BK	160mm	Matte Black	10	6.17
P87218-PC	160mm	Pol Chrome	10	7.49
P87218-SN	160mm	Satin Nickel	10	7.63



### PRIDE

### KNOBS & PULLS

#### Charleston Cup Pulls



Code	C/C	Finish	Ctn	List/ea
P90396-10B	3" / 96mm	Oil R Bronze	15	\$ 10.76
P90396-BK	3" / 96mm	Matte Black	15	10.97
P90396-DP	3" / 96mm	Dk Pewter	15	10.15
P90396-PC	3" / 96mm	Pol Chrome	15	9.58
P90396-RG	3" / 96mm	Rose Gold	15	11.25
P90396-SN	3" / 96mm	Satin Nickel	15	10.31

#### Cup Pulls

Overall Length: 3-1/2"



Code	C/C	Finish	Ctn	List/ea
P82981-10B	3"	Oil R Bronze	20	\$ 5.84
P82981-BK	3"	Matte Black	20	5.78
P82981-DP	3"	Dk Pewter	20	5.65
P82981-PC	3"	Pol Chrome	20	5.26
P82981-RG	3"	Rose Gold	20	6.21
P82981-SN	3"	Satin Nickel	20	5.76

#### Cup Pulls

Overall Length: 3-1/2"



Code	C/C	Finish	Ctn	List/ea
P953-RG	3"	Rose Gold	25	\$ 7.58
P953-SN	3"	Satin Nickel	25	6.87

#### Cup Pulls

Overall Length: 4-1/2"



Code	C/C	Finish	Ctn	List/ea
P80753-10B	3"	Oil R Bronze	25	\$ 7.05
P80753-BK	3"	Matte Black	25	5.57
P80753-RG	3"	Rose Gold	25	7.39
P80753-SN	3"	Satin Nickel	25	5.36

#### Tab Pulls

Aluminum

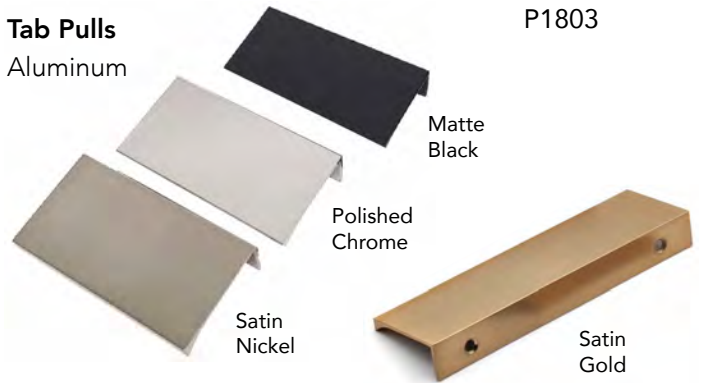

P1803

Code	Description	Finish	Ctn	List/ea
P1803-BK	3" OA, 46mm C/C	Matte Blk	50	\$ 5.74
P1803-PC	3" OA, 46mm C/C	Pol Chrm	50	6.01
P1803-SG	3" OA, 46mm C/C	Sat Gold	50	6.63
P1803-SN	3" OA, 46mm C/C	Sat Nickel	50	5.40
P1806-BK	6" OA, 112mm C/C	Matte Blk	30	9.97
P1806-PC	6" OA, 112mm C/C	Pol Chrm	30	10.46
P1806-SG	6" OA, 112mm C/C	Sat Gold	30	11.33
P1806-SN	6" OA, 112mm C/C	Sat Nickel	30	9.45
P1809-BK	9" OA, 189mm C/C	Matte Blk	30	14.49
P1809-PC	9" OA, 189mm C/C	Pol Chrm	30	15.31
P1809-SG	9" OA, 189mm C/C	Sat Gold	30	17.85
P1809-SN	9" OA, 189mm C/C	Sat Nickel	30	12.51
P1812-BK	12" OA, 132mm C/C	Matte Blk	25	17.30
P1812-PC	12" OA, 132mm C/C	Pol Chrm	25	20.18
P1812-SG	12" OA, 132mm C/C	Sat Gold	25	23.00
P1812-SN	12" OA, 132mm C/C	Sat Nickel	25	17.31



P1876

Code	Description	Finish	Ctn	List/ea
P1876-10B	3" OA, 60mm C/C	Oil R Brz	25	\$ 8.13
P1876-BK	3" OA, 60mm C/C	Matte Blk	25	7.15
P1876-SN	3" OA, 60mm C/C	Sat Nickel	25	7.79

#### 2" Tab Pulls

Steel



P80014

Code	Description	Finish	Ctn	List/ea
P80014-10B	2" OA Length	Oil R Brz	25	\$ 6.37
P80014-BK	2" OA Length	Matte Blk	25	6.22
P80014-SN	2" OA Length	Sat Nickel	25	6.22

## KNOBS & PULLS



Amerock's styles and finishes coordinate with popular cabinet colors creating a cohesive look in your home or office. Cabinet hardware is the finishing touch that elevates these spaces with the perfect blend of beauty and function. See more styles and finishes on amerock.com.

### Finishes



26  
 Polished  
 Chrome



3 / B  
 Brass



BBZ  
 Gold  
 Champagne



G10  
 Satin Nickel



AS  
 Antique  
 Silver



BBR  
 Black Bronze



ORB  
 Oil Rubbed  
 Bronze



FB  
 Flat Black

5

### AMEROCK KNOBS Packed 25 ea/ box.



BP53001  
 Dia: 1-3/16"



BP53002  
 Dia: 1-3/16"



BP53005  
 Dia: 1-1/4"



BP53011  
 Dia: 1-1/4"



BP53012  
 Dia: 1-1/4"



BP53015  
 Dia: 1-1/4"

Code	Finish	List/ea
BP53001-ORB	Oil R. Bronze	\$ 4.12
BP53002-ORB	Oil R. Bronze	3.34
BP53005-26	Polished Chrome	2.56
BP53005-3	Polished Brass	2.33
BP53005-FB	Flat Black	2.95
BP53005-G10	Satin Nickel	2.55
BP53005-ORB	Oil R. Bronze	2.56
BP53011-FB	Flat Black	4.82
BP53011-G10	Satin Nickel	4.82
BP53012-26	Polished Chrome	3.34
BP53012-FB	Flat Black	3.34
BP53012-G10	Satin Nickel	3.34
BP53012-ORB	Oil R. Bronze	3.84
BP53015-G10	Satin Nickel	4.82

### AMEROCK PULLS Packed 25 ea/ box.



BP53003  
 96mm C/C



BP53004  
 96mm C/C



BP53007  
 3" C/C



BP53470  
 3" C/C

Code	Finish	List/ea
BP53003-FB	Flat Black	\$ 4.72
BP53003-G10	Satin Nickel	4.01
BP53003-ORB	Oil R. Bronze	5.51
BP53004-G10	Satin Nickel	4.30
BP53004-ORB	Oil R. Bronze	5.38
BP53007-G10	Satin Nickel	2.94
BP53470-G10	Satin Nickel	6.47
BP53470-ORB	Oil R. Bronze	6.46



## AMEROCK

## KNOBS AND PULLS

### AMEROCK CUP PULLS



**BP4235**  
Solid Brass  
3-1/2" x 1-3/4"  
3" C/C



**BP53010**  
3-7/16" x 1-5/8"  
3" C/C



**BP53019**  
3-3/16" x 1-1/8"  
2-1/2" C/C (64mm)



**BP9365**  
4-1/16" x 1-1/4"  
2-1/2" C/C (64mm)

Code	Finish	Ctn	List/ea
BP4235-G9	Sterling Nickel	25 ea.	\$ 22.82
BP53010-26	Pol. Chrome	25	6.98
BP53010-FB	Flat Black	25	7.99
BP53010-G10	Satin Nickel	25	8.00
BP53010-ORB	Oil R. Bronze	25	6.18
BP53019-G10	Satin Nickel	25	5.39
BP9365-G10	Satin Nickel	10	11.50

### AMEROCK TRADITIONAL KNOBS AND PULLS



**BP1300**  
3" C/C



**BP26131**  
1" Sq.



**BP1302**  
3" C/C



**BP26117**  
1" Sq.

Code	Finish	Ctn	List/ea
BP1300-ORB	Oil R Bronze	25 ea.	\$ 8.98
BP1302-ORB	Oil R Bronze	25	7.68
BP26117-G10	Satin Nickel	25	5.81
BP26131-ORB	Oil R Bronze	25	6.93

### AMEROCK TRADITIONAL KNOBS AND PULLS



**BP53013**  
3" C/C



**BP55342**  
Dia: 1-1/4"



**BP53014**  
1-3/8" L x 1"W



**BP53471**  
Dia: 1-1/4"

Code	Finish	Ctn	List/ea
BP53013-G10	Satin Nickel	25 ea.	\$ 3.83
BP53013-ORB	Oil R Bronze	25	3.83
BP53014-FB	Flat Black	25	3.83
BP53014-G10	Satin Nickel	25	3.83
BP53014-ORB	Oil R. Bronze	25	4.05
BP55342-G10	Satin Nickel	25	7.70
BP55342-ORB	Oil R Bronze	25	7.70
BP53471-G10	Satin Nickel	25	5.83
BP53471-ORB	Oil R. Bronze	25	5.84



**BP55343**  
3" C/C



**BP55340**  
1-1/4" L



**BP53031**  
96mm C/C



**BP53030**  
3" C/C



**BP53029**  
1-1/4" L  
T-Knob

BP55343-ORB	Oil R Bronze	25 ea.	\$ 7.68
BP55340-ORB	Oil R Bronze	25	7.68
BP53029-G10	Satin Nickel	25	8.61
BP53029-ORB	Oil R Bronze	25	8.61
BP53030-G10	Satin Nickel	25	10.05
BP53031-G10	Satin Nickel	25	11.46
BP53031-ORB	Oil R Bronze	25	11.52



## KNOBS AND PULLS

## AMEROCK

### AMEROCK TRANSITIONAL KNOBS AND PULLS

### AMEROCK TRANSITIONAL KNOBS AND PULLS



BP55275  
3" C/C

BP55276  
96mm C/C

BP55277  
128mm C/C

BP55278  
160mm C/C



BP53721  
128mm C/C

BP53720  
96mm C/C



BP53718  
Dia: 1-3/16"

5



BP55270  
Dia: 1-5/16"



BP55271  
1-3/16" Sq.

BP53719  
3" C/C



BP1590  
3" C/C



BP1585  
Dia: 1-1/4"



BP29349  
3" C/C

BP29355  
96mm C/C

BP29363  
128mm C/C

BP29364  
160mm C/C



BP1586  
Dia: 1-3/4"



BP29340  
1-1/4" L x 1" W

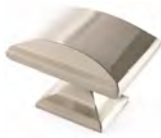

BP29368  
1-1/2" L x 1-1/4" W



BP24010  
Dia: 30mm



BP53702  
96mm C/C

BP53701  
3" C/C



BP53700  
Dia: 1-1/4"



BP53704  
3" C/C

Code	Finish	Ctn	List/ea
BP55270-	BBR,G10	25 ea.	\$ 7.70
BP55271-	BBR,G10,ORB	25	8.98
BP55275-	BBR,G10	25	8.98
BP55276-	BBR,G10,ORB	25	10.25
BP55277-	BBR,G10,ORB	10	11.63
BP55278-	BBR,G10,ORB	10	13.46
BP29340-	AS,G10,ORB	25	7.21
BP29349-	AS,G10,ORB	25	8.61
BP29355-	G10,ORB	10	10.07
BP29363-	G10	10	11.48
BP29364-	G10	10	11.51
BP29368-	G10	10	10.05
BP24010-	SN	10	9.89

Code	Finish	Ctn	List/ea
BP53718-	G10	25 ea.	\$ 7.68
BP53719-	G10	25	9.00
BP53720-	G10	25	10.25
BP53721-	G10	25	11.52
BP1590-	G10,ORB	25	7.68
BP1586-	G10,ORB	25	7.68
BP1585-	ORB	25	6.42
BP53700-	G10,ORB	25	8.42
BP53701-	G10	25	7.68
BP53702-	G10,ORB	25	9.83
BP53704-	G10	25	6.60



## AMEROCK

## KNOBS AND PULLS

### AMEROCK CONTEMPORARY KNOBS AND PULLS

### AMEROCK CONTEMPORARY KNOBS AND PULLS



BP19201  
128mm C/C



BP3416  
3" C/C



BP26201  
3" C/C

BP26203  
96mm C/C

BP9362  
128mm C/C

BP26204  
160mm C/C



BP36572  
160mm C/C



BP19200  
128mm C/C



BP24013  
128mm C/C



BP36574  
96mm C/C



BP4478  
96mm C/C



BP24017  
160mm C/C

BP24018  
96mm C/C



BP27016  
96mm C/C

5

Code	Finish	Ctn	List/ea
BP3416-26	Pol Chrome	25 ea.	\$ 3.34
BP19201-G10	Satin Nickel	10	12.09
BP26201-G10	Satin Nickel	25	7.70
BP26203-G10	Satin Nickel	25	13.40
BP9362-G10	Satin Nickel	10	14.08
BP26204-G10	Satin Nickel	10	17.32
BP36572-ORB	Oil R Bronze	10	9.31
BP36572-G10	Satin Nickel	10	9.31
BP19200-G10	Satin Nickel	10	13.20
BP24013-SN	Satin Nickel	10	15.39
BP24013-SS	Stainless Steel	10	15.53

Code	Finish	Ctn	List/ea
BP36574-G10	Satin Nickel	50	\$ 7.79
BP4478-G10	Satin Nickel	25	4.29
BP24017-SN	Satin Nickel	10	15.39
BP24018-SN	Satin Nickel	10	14.10
BP27016-G10	Satin Nickel	10	10.47
BP4478-G10	Satin Nickel	25	4.29



## APPLIANCE PULLS

## KNOBS

### AMEROCK APPLIANCE PULLS - Special Order

Other sizes and styles available: amerock.com

Bar Pull



BP54008  
12" C/C

Black Rock



BP55280  
12" C/C

Candler



BP29366  
12" C/C

Cyprus



BP26206  
12" C/C

Code	Finishes	List/ea
BP54008-	BBR, BBZ, GM, ORB, PN, SS	\$ 140
BP55280-	BBR, BBZ, ORB, PN, G10	153
BP29366-	BBR, BBZ, ORB, PN, G10, AS	112
BP26206-	BBR, BBZ, ORB, PN, G10	153

BBR -	Black Bronze	BBZ -	Golden Champagne
GM -	Gunmetal	ORB -	Oil Rubbed Bronze
PN -	Polished Nickel	SS -	Stainless Steel
G10 -	Satin Nickel	AS -	Antique Silver

\*See other Appliance Pulls on pgs. 545 (Emtek) and 557 (Pride)

### AMEROCK HARDWOOD KNOBS



811 - 1-1/4"  
813 - 1-1/2"  
814 - 2"

Unfinished Birch. 2 ea/pk, 25 packs/ carton.

Code	Diameter	Specie	List/pk
BP811-WD	1-1/4"	Birch	\$ 3.81
BP813-WD	1-1/2"	Birch	3.81
BP814-WD	2"	Birch	5.43

### WADDELL OAK CABINET KNOBS

2 knobs per bag.



921 OAK

Code	Size	Bgs/box	List/bg
921-114-OAK	1-1/4" Dia.	10	\$ 1.60

### Ball Knob

Hardwood with screws for 3/4" drawer front. 2 ea/bg except where noted.



Code	Size	Ctn	List/bg
11405-1DP	1" Dia	10 ea.	\$ 1.71
11405-112DP	1-1/2" Dia	10	1.95
11405-2DP*	2" Dia	10	1.89

\*1 ea/bg

### BELWITH PORCELAIN KNOBS



P29W  
Dia: 1-1/2"

Code	Finish	Ctn	List/ea
P29W	White Porcelain	25 ea.	\$ 5.14





## BERENSON

## KNOBS AND PULLS

### ASPIRE COLLECTION



9231-1BPN-P  
96mm C/C



9237-1BPN-P  
160mm C/C

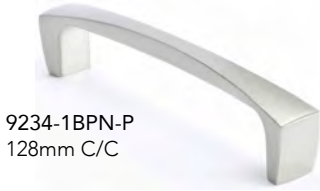

9234-1BPN-P  
128mm C/C



9240-1BPN-P  
12" C/C



9243-1BPN-P

### OASIS COLLECTION



9246-1BPN-P  
96mm C/C



9247-10BT-P  
96mm C/C



9249-1BPN-P  
128mm C/C



9251-1ORB-P  
160mm C/C



9255-1BPN-P

Code	Description	L x W x H	List/ea
9231-1BPN-P	Pull, 96mm C/C, Brushed Nickel	4-1/8" x 11/16" x 1-1/4"	\$ 9.44
9234-1BPN-P	Pull, 128mm C/C, Brushed Nickel	5-7/16" x 11/16" x 1-1/4"	10.41
9237-1BPN-P	Pull, 160mm C/C, Brushed Nickel	6-1/2" x 11/16" x 1-1/4"	13.31
9240-1BPN-P	Appliance Pull, 12" C/C	12-7/16" x 1" x 1-13/16"	77.82
9243-1BPN-P	Knob, Brushed Nickel	1-1/4" x 3/4" x 1-3/16"	6.61

Code	Description	L x W x H	List/ea
9246-1BPN-P	Pull, 96mm C/C, Brushed Nickel	4-7/8" x 13/16" x 1-1/8"	\$ 8.43
9247-10BT-P	Pull, 96mm C/C, Brushed Tin	4-7/8" x 13/16" x 1-1/8"	9.44
9249-1BPN-P	Pull, 128mm C/C, Brushed Nickel	6-1/16" x 13/16" x 1-1/16"	10.73
9251-1ORB-P	Pull, 160mm C/C, Oil R Bronze	7-5/16" x 13/16" x 1-1/16"	11.05
9255-1BPN-P	Knob, Dia: 1-1/4", Oil R Bronze	1-1/4" x 1-1/4" x 1-1/16"	6.63



## KNOBS AND PULLS

## BERENSON

### TEMPO COLLECTION - Bar Pulls



Pack: 10 ea.

Code	Description	L x W x H	List/ea
0800-2BPN-P	3" C/C, Brushed Nickel	5-5/16" x 1/2" x 1-1/4"	\$ 7.56
0802-2BPN-P	96mm C/C, Brushed Nickel	6-1/8" x 1/2" x 1-1/4"	9.17
0803-20VB-P	96mm C/C, Verona Bronze	6-1/8" x 1/2" x 1-1/4"	9.10
2013-2026-P	96mm C/C, Pol. Chrome	6-1/8" x 1/2" x 1-1/4"	8.39
0804-2BPN-P	128mm C/C, Brushed Nickel	7-3/8" x 1/2" x 1-1/4"	12.07

### ZURICH COLLECTION - Wire Pulls



Pack: 50 ea.

Code	Description	L x W x H	List/ea
6131-2SC-P	Wire Pull, 96mm C/C, Brushed Chrome	4-1/16" x 5/16" x 1-1/4"	\$ 2.18
6143-226-P	Wire Pull, 3" C/C, Pol. Chrome	3-5/16" x 5/16" x 1-1/4"	2.25
6180-2ORB-P	Wire Pull, 4" C/C, Oil R Bronze	4-5/16" x 5/16" x 1-1/4"	4.26

### ADAGIO COLLECTION Oil Rubbed Bronze Finish



7908-1ORB-P  
Dia: 1-1/4"

Pack: 25 ea.

Code	Description	L x W x H	List/ea
7908-1ORB-P	Round Knob	1-1/4" x 1-1/4" x 1-1/16"	\$ 8.05

### SUBTLE SURGE COLLECTION



Pack: 10 ea.

Code	Description	L x W x H	List/ea
1248-1BPN-P	Pull, 128mm C/C, Brushed Nickel	5-9/16" x 7/16" x 1-3/8"	\$ 10.29



# BERENSON

# TAB PULLS

## BRAVO COLLECTION - Tab Pulls

### 32mm C/C, 1-3/4" O/A Length



1052-4BPN-P



1055-40VB-P



1053-4026-P



1056-4055-P

### 56mm C/C, 3" O/A Length



1057-4BPN-P



1059-40VB-P



1070-40SG-P



1058-4026-P



1060-4055-P

### 4-7/16" C/C, 6" O/A Length



1061-4BPN-P



1063-40VB-P



1071-40SG-P



1062-4026-P



1064-4055-P

## BRAVO COLLECTION - Tab Pulls

### 6-11/16" C/C, 9-1/16" O/A Length



1065-4BPN-P



1066-4026-P



1067-40VB-P



1068-4055-P

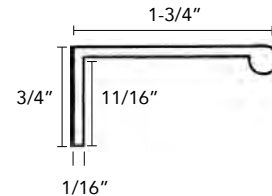

Pack: 25 ea.

Code	Finish	Length	C/C	List/ea
1052-4BPN-P	Brushed Nickel	1-3/4"	32mm	\$ 8.53
1053-4026-P	Pol. Chrome	1-3/4"	32mm	8.14
1055-40VB-P	Verona Bronze	1-3/4"	32mm	8.53
1056-4055-P	Satin Black	1-3/4"	32mm	8.54
1057-4BPN-P	Brushed Nickel	3"	56mm	11.95
1058-4026-P	Pol. Chrome	3"	56mm	11.38
1059-40VB-P	Verona Bronze	3"	56mm	11.98
1060-4055-P	Satin Black	3"	56mm	11.95
1070-40SG-P	Satin Gold	3"	56mm	11.51
1061-4BPN-P	Brushed Nickel	6"	4-7/16"	19.31
1062-4026-P	Pol. Chrome	6"	4-7/16"	19.31
1063-40VB-P	Verona Bronze	6"	4-7/16"	19.31
1064-4055-P	Satin Black	6"	4-7/16"	19.31
1071-40SG-P	Satin Gold	6"	4-7/16"	15.85
1065-4BPN-P	Brushed Nickel	9-1/16"	6-11/16"	23.29
1066-4026-P	Pol. Chrome	9-1/16"	6-11/16"	23.32
1067-40VB-P	Verona Bronze	9-1/16"	6-11/16"	19.12
1068-4055-P	Satin Black	9-1/16"	6-11/16"	22.18

5



## KNOBS AND PULLS

## BERENSON

### METRO COLLECTION



4108-1BPN-P  
96mm C/C



4109-1026-P  
96mm C/C



4111-1055-P  
96mm C/C

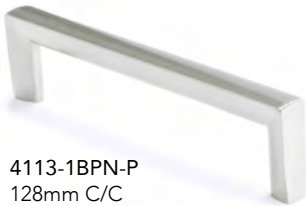

4113-1BPN-P  
128mm C/C



4114-1026-P  
128mm C/C



4116-1055-P  
128mm C/C



9898-1MDB-P  
128mm C/C

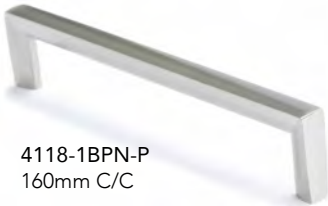

4118-1BPN-P  
160mm C/C



4119-1026-P  
160mm C/C

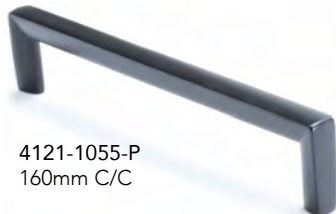

4121-1055-P  
160mm C/C

### METRO COLLECTION



4122-1BPN-P



4126-1055-P

#### Pulls

96mm Packed 25 ea, other sizes 10 ea.

Code	Description	L x W x H	List/ea
4108-1BPN-P	96mm C/C, Brushed Nickel	4-3/16" x 7/16" x 1-5/16"	\$ 9.36
4109-1026-P	96mm C/C, Pol. Chrome	4-3/16" x 7/16" x 1-5/16"	7.80
4111-1055-P	96mm C/C, Matte Black	4-3/16" x 7/16" x 1-5/16"	9.33
4113-1BPN-P	128mm C/C, Brushed Nickel	5-7/16" x 7/16" x 1-5/16"	11.38
4114-1026-P	128mm C/C, Pol. Chrome	5-7/16" x 7/16" x 1-5/16"	11.38
4116-1055-P	128mm C/C, Matte Black	5-7/16" x 7/16" x 1-5/16"	11.38
9898-1MDB-P	128mm C/C, Brushed Gold	5-7/16" x 7/16" x 1-5/16"	9.34
4118-1BPN-P	160mm C/C, Brushed Nickel	6-11/16" x 7/16" x 1-5/16"	9.82
4119-1026-P	160mm C/C, Pol. Chrome	6-11/16" x 7/16" x 1-5/16"	9.82
4121-1055-P	160mm C/C, Matte Black	6-11/16" x 7/16" x 1-5/16"	11.38

#### Knobs, Packed 25 ea.

4122-1BPN-P	1-3/16" Sq, Brushed Nickel	1-3/16" x 1-3/16" x 1-1/4"	\$ 6.39
4126-1055-P	1-3/16" Sq, Matte Black	1-3/16" x 1-3/16" x 1-1/4"	5.51

5



## BERENSON

## KNOBS AND PULLS

### SKYLINE COLLECTION

### SKYLINE COLLECTION

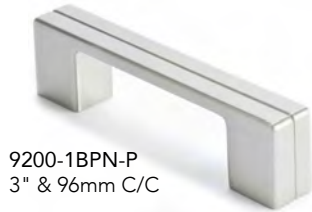

9200-1BPN-P  
3" & 96mm C/C



9201-1026-P  
3" & 96mm C/C



9202-1055-P  
3" & 96mm C/C

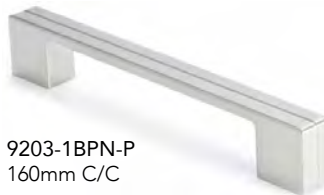

9203-1BPN-P  
160mm C/C



9205-1055-P  
160mm C/C



9207-1026-P  
224mm C/C



9206-1BPN-P  
224mm C/C



9208-1055-P  
224mm C/C



9209-1BPN-P

Pack: 25 ea.

Code	Description	L x W x H	List/ea
9200-1BPN-P	Pull, 3 & 96mm C/C, Brushed Nickel	4-13/16" x 5/8" x 1-1/16"	\$ 12.34
9201-1026-P	Pull, 3 & 96mm C/C, Pol. Chrome	4-13/16" x 5/8" x 1-1/16"	11.79
9202-1055-P	Pull, 3 & 96mm C/C, Matte Black	4-13/16" x 5/8" x 1-1/16"	11.76
9203-1BPN-P	Pull, 160mm C/C, Brushed Nickel	6-11/16" x 5/8" x 1-1/16"	19.31
9205-1055-P	Pull, 160mm C/C, Matte Black	6-11/16" x 5/8" x 1-1/16"	15.91
9206-1BPN-P	Pull, 224mm C/C, Brushed Nickel	9-1/4" x 5/8" x 1-1/16"	26.43
9207-1026-P	Pull, 224mm C/C, Pol. Chrome	9-1/4" x 5/8" x 1-1/16"	26.43
9208-1055-P	Pull, 224mm C/C, Matte Black	9-1/4" x 5/8" x 1-1/16"	26.43
9209-1BPN-P	Knob, Brushed Nickel	1-3/8" x 3/4" x 1-1/16"	6.73

5



## KNOBS AND PULLS

## BERENSON

### ECHO COLLECTION



9228-1BPN-P  
Dia: 1-3/16"



9222-1BPN-P  
3" C/C

9225-1BPN-P  
96mm C/C



9258-1014-P  
96mm C/C



9261-1055-P  
96mm C/C



9262-1055-P  
Dia: 1-3/16"

Pack: 25 ea.

Code	Description	L x W x H	List/ea
9222-1BPN-P	Pull, 3" C/C, Brushed Nickel	4-3/4" x 3/4" x 1-1/8"	\$ 7.79
9225-1BPN-P	Pull, 96mm C/C, Brushed Nickel	5-9/16" x 3/4" x 1-1/4"	11.28
9258-1014-P	Pull, 96mm C/C, Pol. Nickel	5-9/16" x 3/4" x 1-1/4"	9.73
9261-1055-P	Pull, 96mm C/C, Matte Black	5-9/16" x 3/4" x 1-1/4"	11.30
9228-1BPN-P	Knob, 1-3/16" Dia, Brushed Nickel	1-3/16" x 1-3/16" x 1-3/16"	8.87
9262-1055-P	Knob, 1-3/16" Dia, Matte Black	1-3/16" x 1-3/16" x 1-3/16"	8.45

### STUDIO COLLECTION

Stainless Steel Finish

2021-90SS-P  
128mm C/C



2022-90SS-P  
160mm C/C



2023-90SS-P  
192mm C/C



2024-90SS-P  
224mm C/C



2025-90SS-P  
256mm C/C



2027-90SS-P  
576mm C/C



Code	Description	L x W x H	List/ea
2021-90SS-P	Pull, 128mm C/C, Stainless Steel	5-5/8" x 9/16" x 1-7/16"	\$ 12.81
2022-90SS-P	Pull, 160mm C/C, Stainless Steel	6-7/8" x 9/16" x 1-7/16"	16.20
2023-90SS-P	Pull, 192mm C/C, Stainless Steel	8-1/8" x 9/16" x 1-7/16"	14.48
2024-90SS-P	Pull, 224mm C/C, Stainless Steel	9-3/8" x 9/16" x 1-7/16"	14.99
2025-90SS-P	Pull, 256mm C/C, Stainless Steel	10-5/8" x 9/16" x 1-7/16"	16.22
2027-90SS-P	Pull, 576mm C/C, Stainless Steel	23-1/4" x 9/16" x 1-7/16"	19.90



## BERENSON

## KNOBS AND PULLS

### HEARTHSTONE COLLECTION



4064-1BPN-P  
3" C/C



4070-1BPN-P  
96mm C/C



4083-1BPN-P  
1-9/16" L



2040-1BPN-P  
128mm C/C



4074-1055-P\*  
96mm C/C



4086-1055-P  
1-9/16" L

Pack: 25 ea.

Code	Description	L x W x H	List/ea
4064-1BPN-P	Pull, 3" C/C, Brushed Nickel	3-15/16" x 3/8" x 1-3/8"	\$ 9.31
4070-1BPN-P	Pull, 96mm C/C, Brushed Nickel	4-13/16" x 3/8" x 1-3/8"	9.39
4074-1055-P	Pull, 96mm C/C, Matte Black	4-13/16" x 3/8" x 1-3/8"	9.31
2040-1BPN-P	Pull, 128mm C/C, Brushed Nickel	6-1/16" x 1/1/2" x 1-7/16"	18.89
4083-1BPN-P	Knob, Brushed Nickel	1-9/16" x 1-1/8" x 1-1/8"	7.71
4086-1055-P	Knob, Matte Black	1-9/16" x 1-1/8" x 1-1/8"	7.71

### ALTO COLLECTION



4106-4055-P  
Dia: 1-3/4"



7902-2VB-P  
288mm C/C

Code	Description	L x W x H	List/ea
7902-2VB-P	Pull, 288mm C/C, Verona Bronze	13-1/4" x 3/8" x 1-1/4"	\$ 17.80
4106-4055-P	Knob, Dia: 1-3/4", Matte Black	1-3/4" x 1-3/4" x 1-3/8"	13.68

### LAURA COLLECTION



4088-1BPN-P  
1-7/16" L

Code	Description	L x W x H	List/ea
4088-1BPN-P	Knob, Brushed Nickel	1-7/16" x 1" x 1"	\$ 7.43

### FLUIDIC COLLECTION



9478-1BPN-P  
128mm C/C



9476-1BPN-P  
96mm C/C

Code	Description	L x W x H	List/ea
9476-1BPN-P	Pull, 96mm C/C, Brushed Nickel	4-11/16" x 13/16" x 1-3/16"	\$ 11.95
9478-1BPN-P	Pull, 128mm C/C, Brushed Nickel	6-1/4" x 13/16" x 1-3/16"	14.65



## KNOBS AND PULLS

## BERENSON

### HARMONY



9578-1VTN-P  
128mm C/C

### 5 MEADOW



2097-4BPN-P  
128mm C/C

2099-4BPN-P  
96mm C/C

Code	Description	L x W x H	List/ea
9578-1VTN-P	Pull, 128mm C/C, Vintage Nickel	5-11/16" x 11/16" x 1-1/8"	\$ 15.67
2097-4BPN-P	Pull, 96mm C/C, Brushed Nickel	5-7/16" x 11/16"	10.70
2099-4BPN-P	Pull, 128mm C/C, Brushed Nickel	6-5/8" x 11/16"	11.32

### ADVANTAGE PLUS COLLECTION



0913-1BPN-P  
1-1/8" C/C



1773-126-P  
1-1/8" C/C

Pack: 25 ea.

Code	Description	Height	List/ea
0913-1BPN-P	Knob, Dia: 1-1/8", Brushed Nickel	1-1/8"	\$ 3.05
1773-126-P	Knob, Dia: 1-1/8", Pol. Chrome	1"	3.32

### SWAGGER



2315-1BPN-P  
160mm C/C

2312-1BPN-P  
128mm C/C

2368-1MDB-P  
1-3/16" Sq.

2366-1MDB-P  
224mm C/C

2364-1MDB-P  
128mm C/C

### DOMESTIC BLISS



2351-1MDB-P  
160mm C/C

2344-10VB-P  
128mm C/C

Code	Description	L x W	List/ea
2312-1BPN-P	Pull, 128mm C/C, Brushed Nickel	5-1/2" x 5/8"	\$ 9.99
2315-1BPN-P	Pull, 160mm C/C, Brushed Nickel	6-3/4" x 5/8"	16.45
2364-1MDB-P	Pull, 128mm C/C, Mod Brushed Gold	5-1/2" x 5/8"	11.94
2366-1MDB-P	Pull, 224mm C/C, Mod Brushed Gold	9-5/16" x 5/8"	22.50
2368-1MDB-P	Knob, 1-3/16" Sq. Mod Brushed Gold		6.15
2344-10VB-P	Pull, 128mm C/C, Verona Bronze	5-3/4" x 5/8"	10.27
2351-1MDB-P	Pull, 224mm C/C, Mod Brushed Gold	7-1/8" x 3/4"	19.75



# EMTEK Modern

# Solid Brass Knobs & Pulls

**All Special Order**  
 Lead time 7-10  
 business days\*

### Available Finishes



Satin Brass  
US4



Oil R Bronze  
US10B



Satin Nickel  
US15



Pol Nickel  
US14



Flat Black  
US19



Pol Chrome  
US26

### BRANDT KNOB



US10B

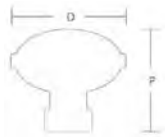

Code	D	P	List/ea
86695-	1-1/4"	1-1/4"	\$ 12
86696-	1-3/4"	1-1/2"	21

### ALLERTON KNOB



US19

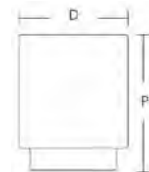

Code	D	P	List/ea
86700-	1"	1-1/4"	\$ 11
86701-	1-1/8"	1-1/4"	12

### HAYDON KNOB



US4

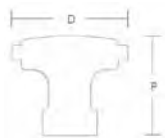

Code	D	P	List/ea
86697-	1-1/4"	1-1/8"	\$ 12
86698-	1-3/4"	1-1/2"	21

### HUNTER KNOB



US14

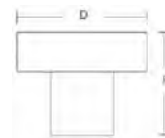

Code	D	P	List/ea
86702-	1-1/4"	1-1/4"	\$ 12
86703-	1-5/8"	1-1/4"	21

### JASPER PULL



Finger Pull  
86699-US15



86686-US15

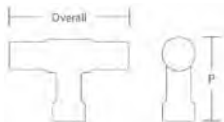

Code	C/C	OA	P	List/ea
86699-	-	2"	1-3/8"	\$ 12
86686-	3-1/2"	4-3/8"	1-3/8"	17
86687-	4"	4-7/8"	1-3/8"	19
86688-	5"	5-7/8"	1-3/8"	21
86689-	6"	6-7/8"	1-3/8"	22
86690-	8"	8-7/8"	1-3/8"	26
86691-	10"	10-7/8"	1-3/8"	37
86692-	12"	12-7/8"	1-3/8"	48

### WARWICK PULL



T-Knob  
86726-US10B



86704-US10B

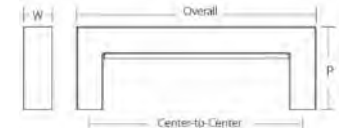
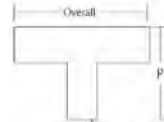

W = 1/2"

Code	C/C	OA	P	List/ea
86726-	-	2"	1-3/8"	\$ 12
86704-	3-1/2"	4"	1-3/8"	17
86705-	4"	4-1/2"	1-3/8"	19
86706-	5"	5-1/2"	1-3/8"	21
86707-	6"	6-1/2"	1-3/8"	22
86708-	8"	8-1/2"	1-3/8"	26
86709-	10"	10-1/2"	1-3/8"	37
86710-	12"	12-1/2"	1-3/8"	48



### Solid Brass Knobs & Pulls

### EMTEK Modern

**All Special Order**  
Lead time 7-10  
business days\*

#### Available Finishes



Satin Brass  
US4



Oil R Bronze  
US10B



Satin Nickel  
US15



Pol Nickel  
US14



Flat Black  
US19



Pol Chrome  
US26

5

#### KEATON PULL



Finger Pull  
86713-US4

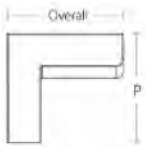

86714-US4

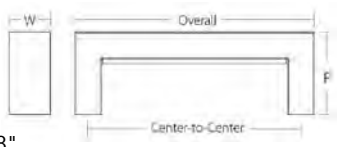

W = 7/8"

Code	C/C	OA	P	List/ea
86713-	-	1-1/2"	1-1/2"	\$ 15
86714-	3-1/2"	4"	1-1/2"	22
86715-	4"	4-1/2"	1-1/2"	23
86716-	5"	5-1/2"	1-1/2"	25
86717-	6"	6-1/2"	1-1/2"	34
86718-	8"	8-1/2"	1-1/2"	44
86719-	10"	10-1/2"	1-1/2"	52
86720-	12"	12-1/2"	1-1/2"	83

#### FREESTONE FINGER PULL



US19

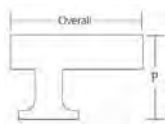

Code	OA	W	P	List/ea
86452-	1-7/8"	1/2"	1-1/8"	\$ 12

#### FREESTONE T-KNOB



US14

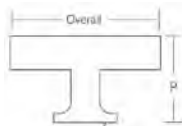

Code	OA	W	P	List/ea
86727-	2"	1/2"	1-1/8"	\$ 12

#### FREESTONE PULL



86453-US10B

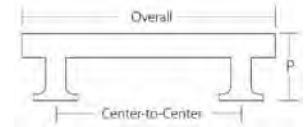

Code	C/C	OA	P	List/ea
86453-	3-1/2"	4-3/4"	1-1/4"	\$ 17
86454-	4"	5-1/4"	1-1/4"	19
86676-	5"	6-3/4"	1-3/8"	21
86455-	6"	7-3/4"	1-3/8"	22
86456-	8"	10-1/2"	1-3/8"	26
86677-	10"	12-1/2"	1-3/8"	37
86678-	12"	14-1/2"	1-3/8"	48

#### FREESTONE EXTENDED PULL



86682-US15



Code	C/C	OA	P	List/ea
86682-	3-1/2"	7"	1-1/4"	\$ 23
86683-	6"	10-1/2"	1-3/8"	37

#### FREESTONE KNOB



US4



Code	D	P	List/ea
86450-	1-1/4"	1-1/4"	\$ 12
86451-	1-1/2"	1-1/4"	21



# EMTEK Modern

# Solid Brass Knobs & Pulls

**All Special Order**  
Lead time 7-10  
business days\*

### Available Finishes



Satin Brass  
US4



Oil R Bronze  
US10B



Satin Nickel  
US15



Pol Nickel  
US14



Flat Black  
US19



Pol Chrome  
US26

### MOD HEX PULL



86459-US15

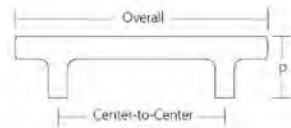

Code	C/C	OA	P	List/ea
86459-	3-1/2"	5-3/8"	1-1/4"	\$ 17
86460-	4"	5-3/4"	1-1/4"	19
86679-	5"	7"	1-3/8"	21
86461-	6"	8"	1-3/8"	22
86462-	8"	10-1/4"	1-3/8"	26
86680-	10"	12-1/4"	1-3/8"	37
86681-	12"	14-1/4"	1-3/8"	48

### MOD HEX EXTENDED PULL



86684-US19

Code	C/C	OA	P	List/ea
86684-	3-1/2"	7"	1-1/4"	\$ 23
86685-	6"	10-1/2"	1-3/8"	37

### MOD HEX T-KNOB



US10B



Code	OA	W	P	List/ea
86728-	2"	1/2"	1-1/4"	\$ 12

### MOD HEX KNOB



US4



Code	D	P	List/ea
86457-	1-1/8"	1-1/4"	\$ 12
86458-	1-1/2"	1-3/8"	21

### CINDER KNOB



US15



Code	OA	C/C	P	List/ea
86446-	1-5/8"	1"	7/8"	\$ 12
86447-	2-1/4"	1"	1"	21

### DISTRICT KNOB



US10B



Code	D	P	List/ea
86448-	1-3/8"	5/8"	\$ 12
86449-	1-5/8"	5/8"	21

5



### Solid Brass Knobs & Pulls

**All Special Order**  
Lead time 7-10  
business days\*

### EMTEK Modern

5

#### Curvilinear Available Finishes



#### Geometric Available Finishes



#### BEZIER KNOB



US10B

Code	D	P	List/ea
86410-	1-3/8"	1"	\$ 12
86411-	1-5/8"	1"	21

#### GEOMETRIC OVAL KNOB



US26



Code	D	P	List/ea
86304-	1-1/4"	1-1/4"	\$ 15
86305-	1-1/2"	1-1/2"	17
86306-	1-3/4"	1-1/2"	24

#### SWEEP PULL



US14

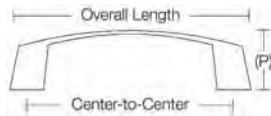

Code	C/C	OA	P	List/ea
86406-	3-1/2"	4-1/8"	1"	\$ 17
86407-	4"	4-3/4"	1"	19
86486-	5"	5-7/8"	1"	21
86408-	6"	6-7/8"	1"	22
86409-	8"	9-1/4"	1"	26
86487-	10"	11-3/8"	1-1/8"	37
86488-	12"	13-1/2"	1-1/4"	48

#### GEOMETRIC SQUARE KNOB



US15

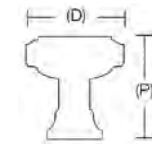

Code	D	P	List/ea
86295-	1-1/4"	1-1/4"	\$ 17
86296-	1-5/8"	1-3/8"	24

#### NEOS BACK PLATES



86420-US15  
Back Plate for Knob

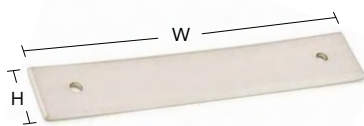

86419-US15  
Back Plate for Pull

Code	Description	W x H	P	List/ea
86420-	Back Plate for Knob	1-1/4" x 1"	1/8"	\$ 7
86419-	For Pull - 4" C/C	5-1/8" x 1"	1/8"	11

#### GEOMETRIC RECTANGULAR PULL



US10B

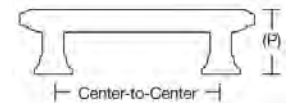

Code	C/C	O/A	P	List/ea
86299-	3"	4-1/4"	1-1/8"	\$ 17
86300-	3-1/2"	4-5/8"	1-1/8"	19
86301-	4"	5-1/4"	1-1/8"	21
86492-	5"	6-1/4"	1-1/8"	22
86302-	6"	7-1/4"	1-1/8"	24
86303-	10"	11-1/4"	1-1/8"	42
86493-	12"	13-1/4"	1-1/8"	56

# EMTEK Contemporary

# Solid Brass Knobs & Pulls

**All Special Order**  
 Lead time 7-10  
 business days\*

### Available Finishes



Satin Brass  
US4



Oil R Bronze  
US10B



Satin Nickel  
US15



Pol Nickel  
US14



Flat Black  
US19



Pol Chrome  
US26

### GLOBE KNOB



US15  
 Removable Backplate  
 included

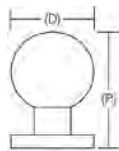

Code	D	P	List/ea
86152-	1-1/8"	1-1/2"	\$ 19

### RING KNOB



US10B

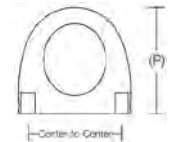

Code	C/C	P	List/ea
86270-	1"	1-1/4"	\$ 12

### METRIC KNOB



US19

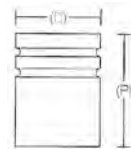

Code	D	P	List/ea
86268-	1"	1-1/4"	\$ 15
86269-	1-1/8"	1-3/8"	19

### ORBIT PULL



US15

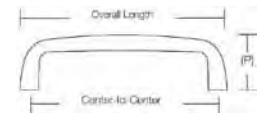

Code	C/C	OA	P	List/ea
86256-	3"	3-3/8"	1"	\$ 17
86257-	3-1/2"	3-7/8"	1"	21
86258-	4"	4-3/8"	1"	22
86259-	6"	6-3/8"	1"	28
86260-	10"	10-3/8"	1"	42

### CONE KNOB



US4

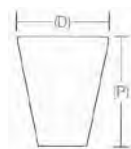

Code	D	P	List/ea
86261-	1"	1-1/8"	\$ 12
86262-	1-1/8"	1-3/8"	17

### TRAIL PULL



US19

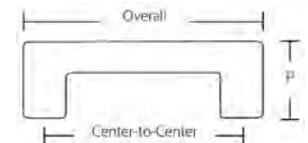

Code	C/C	OA	P	List/ea
86161-	3"	3-3/4"	1-3/8"	\$ 17
86162-	3-1/2"	4-1/4"	1-3/8"	21
86163-	4"	4-3/4"	1-3/8"	22
86272-	5"	5-3/4"	1-3/8"	24
86164-	6"	6-3/4"	1-3/8"	28
86165-	8"	8-3/4"	1-3/8"	35
86273-	10"	10-3/4"	1-3/8"	42
86166-	12"	12-3/4"	1-3/8"	57
86274-	16"	16-3/4"	1-3/8"	75

### FINGER PULL



US14

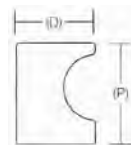

Code	D	P	List/ea
86150-	7/8"	1"	\$ 12
86151-	1"	1-1/4"	13



### Solid Brass Knobs & Pulls

### EMTEK Contemporary

**All Special Order**  
Lead time 7-10  
business days\*

#### Available Finishes



Satin Brass  
US4



Oil R Bronze  
US10B



Satin Nickel  
US15



Pol Nickel  
US14



Flat Black  
US19



Pol Chrome  
US26

5

#### TRAIL KNOB



US14

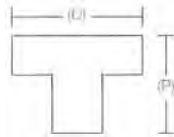

Code	D	P	List/ea
86271-	2"	1-3/8"	\$ 15

#### BAR KNOB



US10B

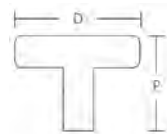

Code	D	P	List/ea
86357-	2"	1-1/4"	\$ 17

#### BAR PULL



US10B

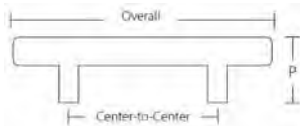

Code	C/C	OA	P	List/ea
86358-	3"	5"	1-1/4"	\$ 24
86359-	3-1/2"	5-1/2"	1-1/4"	28
86360-	4"	6-1/2"	1-1/4"	33
86361-	5"	7-1/2"	1-1/4"	35
86362-	6"	8-1/2"	1-1/4"	37
86363-	8"	10-1/2"	1-1/4"	42
86364-	10"	12-1/2"	1-1/4"	48
86365-	12"	14-1/2"	1-1/4"	57
86366-	16"	18-1/2"	1-1/4"	66
86367-	24"	26-1/2"	1-1/4"	88

#### TRINITY PULL



US4

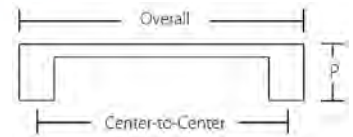

Code	C/C	OA	P	List/ea
86263-	3"	3-1/2"	1"	\$ 17
86264-	3-1/2"	4"	1"	21
86265-	4"	4-1/2"	1"	22
86482-	5"	5-1/2"	1"	24
86266-	6"	6-1/2"	1"	28
86438-	8"	8-1/2"	1"	35
86267-	10"	10-1/2"	1"	42
86483-	12"	12-1/2"	1"	57

#### EDGE PULL



US15

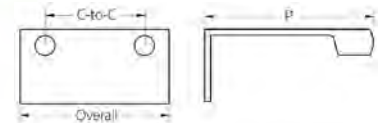

Code	C/C	OA	P	List/ea
87160-	1"	1-1/2"	1-3/4"	\$ 8
87100-	3"	4-1/4"	1-3/4"	13
87110-	4"	5-1/4"	1-3/4"	15
87120-	6"	7-1/4"	1-3/4"	19
87130-	8"	9-1/4"	1-3/4"	24
87140-	10"	11-1/4"	1-3/4"	32
87150-	12"	13-1/4"	1-3/4"	41

# EMTEK

**All Special Order**  
**Lead time 7-10**  
**business days\***

## Solid Brass Knobs & Pulls

### Carbon Fiber

Available Finishes

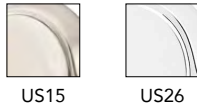

### Mid Century Modern Available Finishes



#### CARBON FIBER KNOBS



Black / US15

Code	Description	D	P	List/ea
86368-	Black	1-1/4"	1-3/8"	\$ 22
86369-	Black	1-5/8"	1-1/2"	34
86370-	Silver	1-1/4"	1-3/8"	22
86371-	Silver	1-5/8"	1-1/2"	34

#### ATOMIC KNOB



US10B

Code	D	P	List/ea
86314-	1"	1"	\$ 11
86315-	1-1/4"	1-1/4"	12
86316-	1-5/8"	1-1/2"	21

#### CARBON FIBER BIN PULLS



Bin Pull / Silver  
 US26 - Pol Chrome

Black	Silver	C/C	OA	P	W	List/ea
86372-	86374-	3"	3-3/8"	1"	1"	\$ 36
86373-	86375-	4"	4-3/8"	1"	1"	47

#### BASIN KNOB



US14

Code	D	P	List/ea
86317-	1-1/4"	3/4"	\$ 12
86318-	1-5/8"	1"	21

#### CARBON FIBER BAR PULLS



Silver / US15

Black / US26

Silver / US26

Black	Silver	C/C	OA	P	List/ea
86376-	86385-	3"	4-1/2"	1-1/4"	\$ 28
86377-	86386-	3-1/2"	5"	1-1/4"	34
86378-	86387-	4"	5-1/2"	1-1/4"	36
86379-	86388-	5"	6-1/2"	1-1/4"	39
86380-	86389-	6"	7-1/2"	1-1/4"	42
86381-	86390-	8"	9-1/2"	1-1/4"	47
86382-	86391-	10"	11-1/2"	1-1/4"	53
86383-	86392-	12"	13-1/2"	1-1/4"	61
86384-	86393-	16"	17-1/2"	1-1/4"	76

#### CADET KNOB



US19

Code	D	P	List/ea
86321-	1"	1-1/8"	\$ 11
86322-	1-1/4"	1-1/8"	12
86323-	1-3/4"	1-3/8"	21



### Solid Brass Knobs & Pulls

**All Special Order**  
Lead time 7-10  
business days\*



5

#### Mid Century Modern

Available Finishes



#### Art Deco

Available Finishes



#### BAUHAUS PULL



US10B



Code	C/C	OA	P	List/ea
86324-	3"	3-3/8"	1-1/8"	\$ 19
86325-	4"	4-3/8"	1-1/8"	22

#### NEWPORT KNOB



US10B

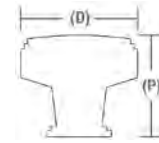

Code	D	P	List/ea
86432-	1-1/4"	1-1/4"	\$ 12
86433-	1-3/4"	1-1/2"	21

#### DANE PULL



US15



Code	C/C	OA	P	List/ea
86309-	3"	3-3/8"	1-1/2"	\$ 15
86310-	3-1/2"	3-7/8"	1-1/2"	17
86311-	4"	4-3/8"	1-1/2"	19
86312-	6"	6-3/8"	1-1/2"	22
86313-	10"	10-3/8"	1-1/2"	37

#### ART DECO KNOB



US14

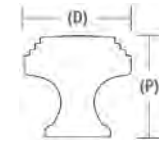

Code	D	P	List/ea
86421-	1-1/4"	1-1/4"	\$ 12

#### ART DECO PULL



US14

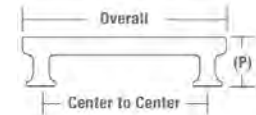

Code	C/C	O/A	P	List/ea
86422-	3-1/2"	4-3/8"	1-1/8"	\$ 17
86423-	4"	4-7/8"	1-1/8"	19

#### ART DECO BACKPLATES



Rectangle Backplate  
US4

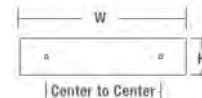

Square  
Backplate  
US4

Code	Description	C/C	W x H	List/ea
86434-	Squ. plate for knobs	-	1-1/4" x 1-1/4"	\$ 7
86435-	Rect. plate for pulls	4"	5-1/4" x 1"	11

#### PODIUM KNOB



US15



Code	D	P	List/ea
86319-	1-1/4"	1-1/8"	\$ 12
86320-	1-3/4"	1-3/8"	21



# EMTEK

**All Special Order**  
 Lead time 7-10  
 business days\*

## Solid Brass Knobs & Pulls

5

### Art Deco

### Available Finishes



### Timeless Classics

### Available Finishes



### TRIBECA PULL



US4

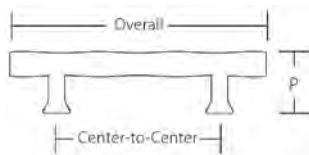

Code	C/C	OA	P	List/ea
86428-	3-1/2"	5-1/2"	1-1/4"	\$ 17
86429-	4"	6"	1-1/4"	19
86489-	5"	7"	1-1/4"	21
86430-	6"	8"	1-1/4"	22
86431-	8"	10"	1-1/4"	26
86490-	10"	12"	1-3/8"	37
86491-	12"	14"	1-3/8"	48

### PAXTON KNOB



US15



Code	D	P	List/ea
86642-	1-1/4"	1"	\$ 12

### LAWSON KNOB



US4

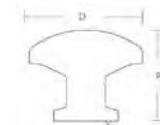

Code	D	P	List/ea
86643-	1-1/4"	1"	\$ 12

### TRIBECA T-KNOB



US10B

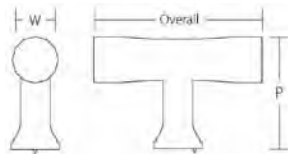

Code	OA	W	P	List/ea
86729-	2"	1/2"	1-3/8"	\$ 12

### KENTER KNOB



US19



Code	D	P	List/ea
86644-	1-1/4"	1"	\$ 12

### ALEXANDER PULL



US15

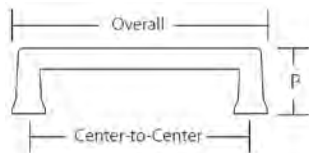

Code	C/C	OA	P	List/ea
86424-	3-1/2"	4-1/8"	1-1/8"	\$ 17
86425-	4"	4-5/8"	1-1/8"	19
86484-	5"	5-5/8"	1-1/8"	21
86426-	6"	6-5/8"	1-1/8"	22
86427-	8"	8-5/8"	1-1/8"	26
86485-	10"	10-5/8"	1-1/8"	37
86479-	12"	12-5/8"	1-1/8"	48

### WESTRIDGE PULL

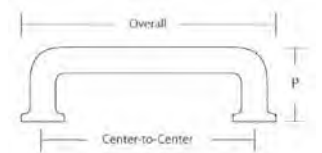

Code	C/C	OA	P	List/ea
86633-	3-1/2"	4-1/4"	1-1/4"	\$ 17
86634-	4"	4-3/4"	1-1/4"	19
86635-	5"	5-3/4"	1-1/4"	21
86636-	6"	6-3/4"	1-1/4"	22
86637-	8"	8-3/4"	1-1/4"	26
86638-	10"	10-3/4"	1-1/4"	37
86639-	12"	12-3/4"	1-1/4"	48



### Solid Brass Knobs & Pulls

### EMTEK Transitional Heritage

**All Special Order**  
Lead time 7-10  
business days\*

#### Available Finishes



Satin Brass  
US4



Oil R Bronze  
US10B



Satin Nickel  
US15



Pol Nickel  
US14



Flat Black  
US19



Pol Chrome  
US26

5

#### GLENDON KNOB



US19

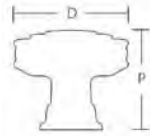

Code	D	P	List/ea
86463-	1-1/4"	1-1/4"	\$ 12
86464-	1-5/8"	1-1/2"	21

#### OVERLAND KNOB



US4



Code	D	P	List/ea
86467-	1-1/4"	1-1/4"	\$ 12
86468-	1-3/4"	1-1/2"	21

#### MIDVALE KNOB



US14

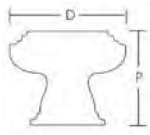

Code	D	P	List/ea
86465-	1-1/4"	1"	\$ 12
86466-	1-3/4"	1-1/4"	21

#### PROSSER KNOB



US10B

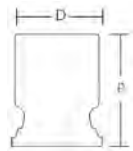

Code	D	P	List/ea
86469-	1"	1-1/4"	\$ 11
86470-	1-1/4"	1-3/8"	12

#### BLYTHE PULL



US10B

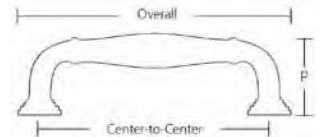

Code	C/C	OA	P	List/ea
86471-	3-1/2"	4-1/4"	1-1/4"	\$ 17
86472-	4"	4-3/4"	1-1/4"	19
86473-	6"	6-5/8"	1-3/8"	22
86474-	8"	8-5/8"	1-1/2"	26

#### WESTWOOD PULL



US15

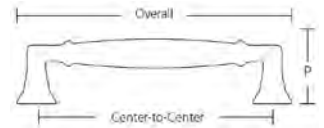

Code	C/C	OA	P	List/ea
86475-	3-1/2"	4-1/4"	1-1/8"	\$ 17
86476-	4"	4-5/8"	1-1/8"	19
86477-	6"	6-5/8"	1-1/8"	22
86478-	8"	8-5/8"	1-1/4"	26

**EMTEK** *Traditional*

**All Special Order**  
 Lead time 7-10  
 business days\*

**Solid Brass Knobs & Pulls**

**Available Finishes**



Pol Brass  
US3



French Antique  
US7



Oil R Bronze  
US10B



Pol Nickel  
US14



Satin Nickel  
US15



Pewter  
US15A



Flat Black  
US19



Pol Chrome  
US26

**EGG KNOB**



US3



Code	D	P	List/ea
86015-	1"	1"	\$ 11
86016-	1-1/4"	1-1/4"	12
86124-	1-3/4"	1-5/8"	22

**NORWICH KNOB**



US15

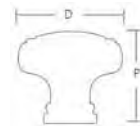

Code	D	P	List/ea
86610-	1-1/4"	1-1/8"	\$ 15
86611-	1-5/8"	1-1/2"	24

**PROVIDENCE KNOB**



US15



Code	D	P	List/ea
86013-	1"	1"	\$ 11
86014-	1-1/4"	1-1/8"	12
86027-	1-3/4"	1-1/2"	22

**HEXAGON KNOB**



US15A

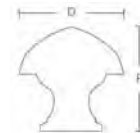

Code	D	P	List/ea
86119-	1-1/8"	1"	\$ 12
86120-	1-3/8"	1-3/8"	15
86204-	1-7/8"	1-3/4"	24

**MELON KNOB**



US7



Code	D	P	List/ea
86121-	1"	1"	\$ 12
86122-	1-1/4"	1-1/4"	15
86203-	1-3/4"	1-3/4"	24

**WAVERLY KNOB**



US7



Code	D	P	List/ea
86114-	1"	1"	\$ 11
86115-	1-1/4"	1-1/8"	12
86201-	1-3/4"	1-1/2"	22

**ROPE KNOB**



US10B

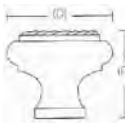

Code	D	P	List/ea
86112-	1"	1"	\$ 12
86113-	1-1/4"	1-1/4"	15
86202-	1-3/4"	1-1/2"	24

**CABINET LATCH**



US10B

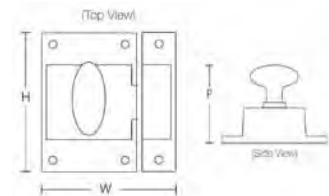

Code	W x H	P	List/ea
2270-	2" x 2-1/4"	1-3/8"	\$ 44

**Solid Brass Knobs & Pulls**

**All Special Order**  
 Lead time 7-10  
 business days\*



**Traditional**

Available Finishes



**Ribbon & Reed**

Available Finishes



5

**CUP PULL**



US10B

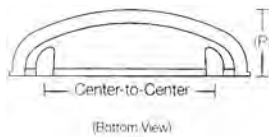

Code	C/C	O/A	Ht	P	List/ea
86123-	3"	4-1/4"	1-1/4"	1-1/8"	\$ 22
86173-	4"	5-1/4"	1-1/2"	1-1/2"	28

**RIBBON & REED KNOB**



US7



Code	D	P	List/ea
86277-	1-1/4"	1-1/4"	\$ 15
86278-	1-3/4"	1-1/2"	24

**WIRE PULL**



US7



Code	C/C	O/A	P	List/ea
86131-	3"	3-1/4"	1-1/4"	\$ 11
86132-	3-1/2"	3-3/4"	1-1/4"	12
86133-	4"	4-1/4"	1-1/4"	14
86249-	6"	6-1/4"	1-1/4"	19

**RIBBON & REED ESTATE PULL**



US15



Code	C/C	O/A	P	List/ea
86283-	3"	3-5/8"	1-1/4"	\$ 23
86284-	3-1/2"	4-1/8"	1-1/4"	24
86285-	4"	4-5/8"	1-1/4"	25
86286-	6"	6-5/8"	1-1/4"	34
86287-	10"	10-5/8"	1-3/8"	58

**SPINDLE PULL**

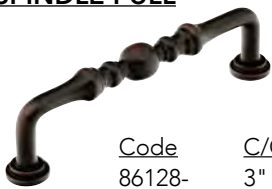

US10B

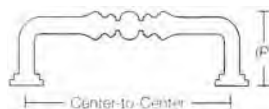

Code	C/C	O/A	P	List/ea
86128-	3"	3-1/2"	1-1/4"	\$ 15
86129-	3-1/2"	4-1/8"	1-1/4"	17
86130-	4"	4-1/2"	1-1/4"	19
86248-	6"	6-1/2"	1-1/4"	22

**RIBBON & REED BACK PLATES**

Back Plate  
 for Knob

US7  
 French Antique

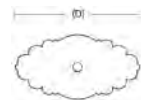

Code	D	W	List/ea
86293-	2-1/2"	1-1/4"	\$ 12

**ROPE PULL**



US15



Code	C/C	O/A	P	List/ea
86125-	3"	3-3/4"	1-1/4"	\$ 23
86126-	3-1/2"	4-1/4"	1-1/4"	24
86127-	4"	4-3/4"	1-1/4"	25
86247-	6"	6-3/4"	1-1/4"	34

Back Plate for Pull  
 US10B / Oil R Bronze



Code	C/C	O/A	W	List/ea
86294-	4"	6-3/4"	1-1/4"	\$ 24

# EMTEK

## Solid Brass Knobs & Pulls

### Arts & Crafts

#### Available Finishes



Satin Brass  
US4



Satin Nickel  
US15



Oil R Bronze  
US10B

**All Special Order  
 Lead time 7-10  
 business days\***

#### HAMMERED BIN PULL



US10B

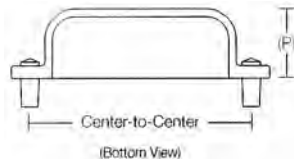

Code	C/C	O/A	Ht	P	List/ea
86049-	3"	3-1/2"	1-1/2"	1"	\$ 28

#### HAMMERED RING PULLS



#86042



Hammered Vertical  
 Ring Pull  
 US15 / Satin Nickel



#86040

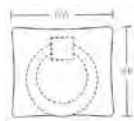

Hammered  
 Ring Pull  
 US10B / Oil R Bronze



#86041

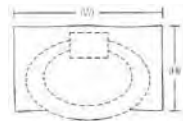

Hammered  
 Oval Pull  
 US4 / Satin Brass

Code	Description	W x H	List/ea
86042-	Vert. Ring Pull	1-1/4" W x 3-1/2" H	\$ 28
86040-	Ring Pull	1-3/4" W x 1-1/2" H	25
86041-	Oval Pull	3" W x 1-3/4" H	28

#### ROUND DIMPLED KNOB



US10B



Code	D	P	List/ea
86037-	1-1/4"	1-1/4"	\$ 19
86213-	1-3/4"	1-1/2"	42

#### SQUARE DIMPLED KNOB



US4



Code	D	P	List/ea
86038-	1"	3/4"	\$ 17
86039-	1-1/4"	1"	19
86212-	1-3/4"	1-1/8"	42

#### HAMMERED PULL



US10B



Code	C/C	O/A	P	List/ea
86046-	3"	3-7/8"	1"	\$ 19
86047-	3-1/2"	4-3/8"	1"	21
86048-	4"	4-7/8"	1"	22

#### MORTISE & TENON PULL



US15



Code	C/C	O/A	P	List/ea
86043-	3"	3-3/8"	1-1/8"	\$ 25
86044-	3-1/2"	3-7/8"	1-1/8"	26
86045-	4"	4-3/8"	1-1/8"	28
86276-	6"	6-3/8"	1-1/8"	36

\*Avail in US10B, US15 and US4 (Satin Brass & Copper)

# EMTEK Glass Knobs & Pulls

**All Special Order**  
 Lead time 7-10  
 business days\*

## Glass Base Finish Options



5

### MODERN GLASS T-KNOB

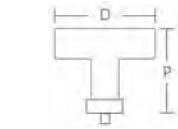

Code	D	P	List/ea
86723-	2-1/8"	1-3/4"	\$ 33

### GRAYSON GLASS KNOB



Code	D	P	List/ea
86569-	1-1/4"	1-1/8"	\$ 26
86570-	1-3/4"	1-1/4"	42

### MODERN GLASS BAR PULL

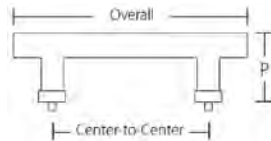

Code	C/C	O/A	P	List/ea
86724-	4"	6"	1-3/4"	\$ 84

### FORZA GLASS KNOB

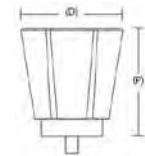

Code	D	P	List/ea
86565-	1-1/4"	1-1/4"	\$ 26

### MODERN GLASS PULL

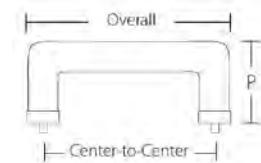

Code	C/C	O/A	P	List/ea
86725-	4"	4-3/4"	1-7/8"	\$ 84

### GEORGETOWN GLASS KNOB



Code	D	P	List/ea
86399-	1-1/4"	1-1/2"	\$ 26
86400-	1-3/4"	1-3/4"	42

### JUNEAU GLASS KNOB

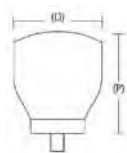

Code	D	P	List/ea
86562-	1-1/8"	1-3/8"	\$ 26

### HAMPTON GLASS KNOB

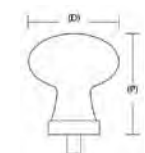

Code	D	P	List/ea
86401-	1-1/4"	1-3/8"	\$ 26
86402-	1-3/4"	1-5/8"	42



**All Special Order**  
Lead time 7-10  
business days\*

# EMTEK Glass Knobs

## Glass Base Finish Options



Pol Brass  
US3



Sat Brass  
US4



French Antique  
US7



Oil R Bronze  
US10B



Pol Nickel  
US14



Satin Nickel  
US15



Pewter  
US15A



Flat Black  
US19



Pol Chrome  
US26

### PROVIDENCE GLASS KNOB



US14



Code	D	P	List/ea
86567-	1-3/8"	1-3/8"	\$ 26
86568-	1-3/4"	1-1/2"	42

### OLD TOWN WARDROBE GLASS KNOB



US15



Code	D	P	List/ea
Clear 86028-	1-3/4"	1-1/2"	\$ 42

### DECO GLASS KNOB



US15

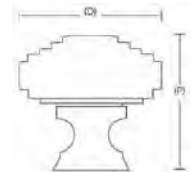

Code	D	P	List/ea
86563-	1-1/4"	1-3/8"	\$ 26
86564-	1-5/8"	1-5/8"	42

### DIAMOND GLASS KNOB



US10B

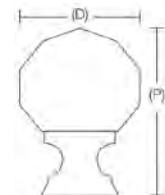

Code	D	P	List/ea
86003-	1"	1-3/8"	\$ 23
86012-	1-1/4"	1-7/8"	26
86209-	1-3/4"	5"	42

### WINDSOR GLASS KNOB



US14



Code	D	P	List/ea
86566-	1-5/8" x 1-1/8"	1-1/4"	\$ 26

### LOWELL GLASS KNOB



US14

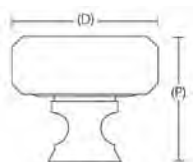

Code	D	P	List/ea
86571-	1-3/8"	1-1/4"	\$ 26

### ASTORIA CRYSTAL KNOB

Clear Base Finish



Clear Base

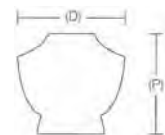

Code	D	P	List/ea
86017	1-1/8"	1-1/8"	\$ 12
86210	1-1/2"	1-1/2"	17

\*Includes 2 screws (US3 & US26)

# EMTEK Knobs

**All Special Order**  
 Lead time 7-10  
 business days\*

## Glass Base Finish Options



### BRISTOL GLASS KNOB

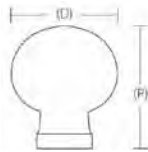

US15

Code	D	P	List/ea
86394-	1"	1-3/8"	\$ 23
86395-	1-1/4"	1-5/8"	26

### BROOKMONT GLASS KNOB

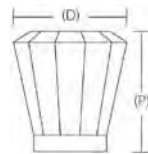

US3

Clear	D	P	List/ea
86396-	1"	1-1/4"	\$ 23
86397-	1-1/4"	1-1/2"	26
86398-	1-5/8"	1-3/4"	42

### LIDO GLASS KNOB

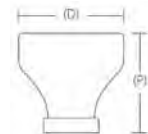

US26

Clear	D	P	List/ea
86403-	1-3/8"	1-3/8"	\$ 26
86404-	1-5/8"	1-1/2"	42

### OLD TOWN GLASS KNOB



US14

Clear	D	P	List/ea
86010-	1"	7/8"	\$ 23
86011-	1-1/4"	1-1/8"	26

## Porcelain

### PORCELAIN KNOB W/ BASE



Ice  
White



Ebony



w/ Pewter Base

Ice White	Ebony	D	P	List/ea
86001-	86009-	1-3/8"	1-3/8"	\$ 15
86034-	86033-	1-3/4"	1-3/4"	26

**Base Finish Options:** Pol. Brass (US3), Satin Brass (US4), French Ant. (US7), Oil R Bronze (US10B), Pol. Nickel (US14), Satin Nickel (US15), Pewter (US15A), Flat Black (US19) & Pol. Chrome (US26)

### MADISON KNOB W/ WROUGHT STEEL STEM



Black



Ivory w/ Satin  
Steel Base

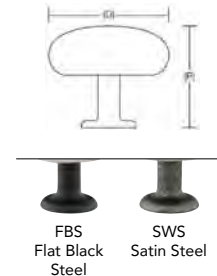

Black	Ivory	D	P	List/ea
86072-	86071-	1-1/4"	1-1/4"	\$ 17
86075-	86074-	1-3/4"	1-3/4"	22



# EMTEK Sandcast Bronze

## Knobs & Pulls

Sandcast Bronze available finishes:  
 FB (Flat Black), MB (Medium), and TWB (Tumbled White)



**All Special Order**  
**Lead time 7-10**  
**business days\***

### RUSTIC MODERN ROUND KNOB



TWB



Code	D	P	List/ea
86660-	1-3/8"	1-1/4"	\$ 19
86661-	1-3/4"	1-3/8"	26

### RUSTIC MODERN SQUARE KNOB

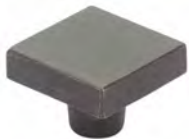

MB

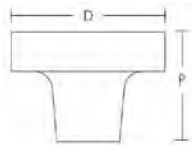

Code	D	P	List/ea
86662-	1-1/4"	1-1/8"	\$ 19
86663-	1-5/8"	1-1/4"	26

### RUSTIC MODERN EDGE PULL



FB

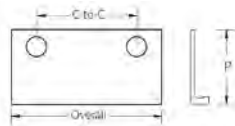

Code	C/C	O/A	P	List/ea
86664-	1-1/2"	3"	2-1/8"	\$ 26
86665-	4-1/2"	6"	2-1/8"	42
86666-	10-1/2"	12"	2-1/8"	76

### RUSTIC MODERN PULL



MB

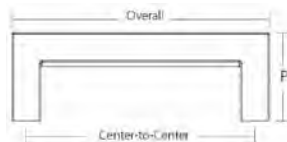

Code	C/C	O/A	P	List/ea
86667-	3-1/2"	4"	1-3/8"	\$ 26
86668-	4"	4-1/2"	1-3/8"	28
86669-	5"	5-1/2"	1-3/8"	33
86670-	6"	6-1/2"	1-3/8"	42
86671-	8"	8-1/2"	1-3/8"	45
86672-	10"	10-1/2"	1-3/8"	58
86673-	12"	12-1/2"	1-3/8"	76

### RANCH BIN PULL



FB

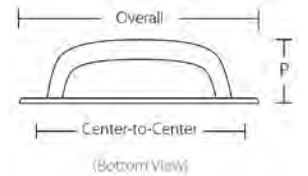

Code	C/C	O/A	Ht	P	List/ea
86326-	3"	3-1/2"	1-5/8"	1"	\$ 24
86327-	4"	4-5/8"	1-3/4"	1"	33

### BIN PULL

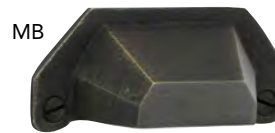

MB

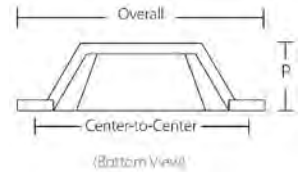

Code	C/C	O/A	Ht	P	List/ea
86051-	3"	3-3/8"	1-1/2"	1"	\$ 24
86050-	4"	4-1/2"	1-5/8"	1"	33

### ROUND BACKPLATE FOR KNOB



TWB

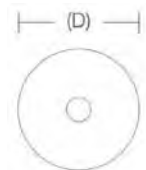

Code	D	Thickness	List/ea
86341-	1-1/4"	1/8"	\$ 11

### SQUARE BACKPLATE FOR KNOB

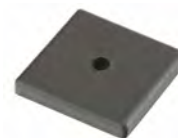

FB

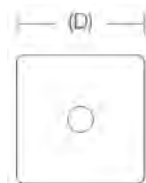

Code	D	Thickness	List/ea
86342-	1-1/4"	1/8"	\$ 11

# EMTEK Sandcast Bronze

## Knobs & Pulls

Sandcast Bronze available finishes:  
 FB (Flat Black), MB (Medium), and TWB (Tumbled White)



**All Special Order  
 Lead time 7-10  
 business days\***

5

### BARN KNOB



MB

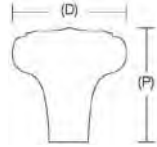

Code	D	P	List/ea
86338-	1"	1"	\$ 17
86339-	1-1/4"	1-1/8"	19
86340-	1-3/4"	1-1/2"	26

### EGG KNOB



TWB

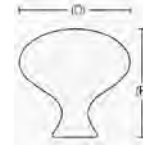

Code	D	P	List/ea
86052-	1"	1"	\$ 17
86053-	1-1/4"	1-1/4"	19
86217-	1-3/4"	1-5/8"	26

### ROUND KNOB



FB

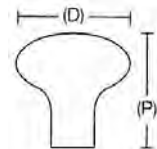

Code	D	P	List/ea
86057-	1"	1"	\$ 17
86058-	1-1/4"	1-1/8"	19
86117-	1-3/4"	1-1/2"	26

### SQUARE KNOB



FB

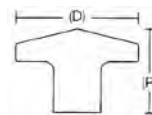

Code	D	P	List/ea
86145-	1-1/4"	1"	\$ 19
86146-	1-5/8"	1-1/8"	26

### ROD PULL



TWB

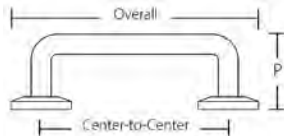

Code	C/C	O/A	P	List/ea
86054-	3"	4"	1-1/4"	\$ 28
86055-	3-1/2"	4-1/2"	1-1/4"	32
86056-	4"	5"	1-1/4"	33
86253-	6"	7"	1-1/4"	42

### PYRAMID PULL



MB

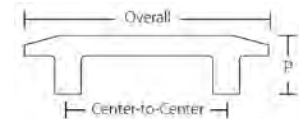

Code	C/C	O/A	P	List/ea
86328-	3"	4"	1"	\$ 28
86329-	3-1/2"	5"	1"	32
86330-	4"	5-1/2"	1"	33
86331-	6"	7-1/2"	1-1/8"	42

### TWIG PULL



MB

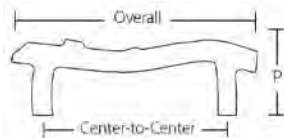

Code	C/C	O/A	P	List/ea
86061-	3"	4-1/8"	1-1/4"	\$ 24
86062-	3-1/2"	4-1/2"	1-1/4"	26
86063-	4"	4-7/8"	1-1/4"	28
86252-	6"	7-3/8"	1-1/4"	42

### RAIL PULL

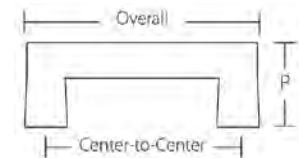

Code	C/C	O/A	P	List/ea
86332-	3"	3-1/2"	1-1/4"	\$ 24
86333-	3-1/2"	4-1/8"	1-1/4"	26
86334-	4"	4-1/2"	1-1/4"	28
86335-	6"	6-1/2"	1-3/8"	42
86336-	8"	8-1/2"	1-3/8"	45
86337-	10"	10-1/2"	1-3/8"	58

# EMTEK *Tuscany Solid Bronze*

## Knobs & Pulls

All Tuscany Bronze available in:  
 FB (Flat Black) and MB (Medium Bronze) finishes.



**All Special Order**  
**Lead time 7-10**  
**business days\***

### FLUTED FINGER KNOB

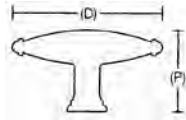

	Code	D	P	List/ea
MB	86227-	1-3/4"	1-1/4"	\$ 22
Med Bronze	86228-	3"	1-5/8"	28

### EGG KNOB



	Code	D	P	List/ea
MB	86093-	1"	1"	\$ 22
Med Bronze	86094-	1-1/4"	1-1/4"	24
	86143-	1-3/4"	1-1/2"	36

### TWIST FINGER KNOB

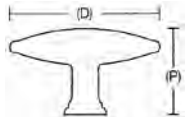

	Code	D	P	List/ea
MB	86097-	1-3/4"	1-1/4"	\$ 22
Med Bronze	86098-	3"	1-3/4"	28

### PETAL KNOB



	Code	D	P	List/ea
FB	86095-	1"	1"	\$ 22
Flat Black	86096-	1-1/4"	1-1/4"	24
	86214-	1-3/4"	1-1/2"	36

### FLUTED ROUND KNOB

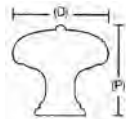

	Code	D	P	List/ea
FB	86229-	1"	1-1/8"	\$ 22
Flat Black	86230-	1-1/4"	1-1/4"	24
	86231-	1-3/4"	1-1/2"	36

### ROUND KNOB

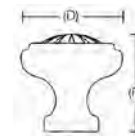

	Code	D	P	List/ea
FB	86091-	1"	1"	\$ 22
Flat Black	86092-	1-1/4"	1-1/4"	24
	86116-	1-3/4"	1-1/2"	36

### TWIST ROUND KNOB



	Code	D	P	List/ea
MB	86244-	1"	1-1/8"	\$ 22
Med Bronze	86245-	1-1/4"	1-1/4"	24
	86246-	1-3/4"	1-1/2"	36

### OCTAGON KNOB



	Code	D	P	List/ea
MB	86137-	1"	1"	\$ 22
Med Bronze	86138-	1-1/4"	1-1/4"	24
	86215-	1-3/4"	1-5/8"	36

# EMTEK *Tuscany Solid Bronze*

All Tuscany Bronze available in:  
 FB (Flat Black) and MB (Medium Bronze) finishes.



## Knobs & Pulls

**All Special Order**  
**Lead time 7-10**  
**business days\***

5

### RIBBED PULL



Code	C/C	O/A	P	List/ea
86100-	3"	3-5/8"	1"	\$ 26
86101-	3-1/2"	4-1/8"	1"	32
86102-	4"	4-5/8"	1"	33
86255-	6"	6-5/8"	1"	45

### BIN PULL

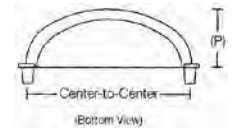

FB  
 Flat Black

Code	C/C	O/A	Ht	P	List/ea
86099-	3"	3-1/2"	1-5/8"	1"	\$ 34
86199-	4"	4-3/8"	2"	1"	42

### FLUTED PULL



Code	C/C	O/A	P	List/ea
86218-	3"	3-5/8"	1-1/2"	\$ 26
86219-	3-1/2"	4-1/4"	1-1/2"	32
86220-	4"	4-5/8"	1-1/2"	33
86221-	6"	6-5/8"	1-1/2"	45
86222-	8"	8-5/8"	1-1/2"	56
86223-	10"	10-5/8"	1-1/2"	76

### FLUTED BIN PULL



MB  
 Med Bronze

Code	C/C	O/A	Ht	P	List/ea
86232-	3"	3-3/8"	1-3/4"	1"	\$ 34
86233-	4"	4-3/8"	1-7/8"	1"	42

### TWIST PULL

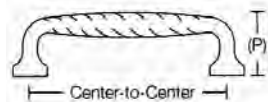

Code	C/C	O/A	P	List/ea
86103-	3"	3-5/8"	1-1/4"	\$ 26
86104-	3-1/2"	4-1/4"	1-1/4"	32
86105-	4"	4-5/8"	1-1/4"	33
86238-	6"	6-5/8"	1-3/8"	45
86239-	8"	8-5/8"	1-3/8"	56
86240-	10"	10-5/8"	1-3/8"	76

### BACK PLATE FOR KNOBS/PULLS

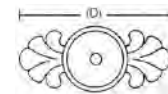

FB  
 Flat Black

Code	D	W	List/ea
86234-	2-1/4"	7/8"	\$ 12



MB  
 Med Bronze

Code	C/C	O/A	W	List/ea
86235-	3"	5-1/4"	7/8"	\$ 15
86236-	3-1/2"	5-3/4"	7/8"	17
86237-	4"	6-1/4"	7/8"	19



# EMTEK

**All Special Order  
Lead time 7-10  
business days\***

## Knobs & Pulls

### Wrought Steel



FBS



SWS

All Wrought Steel available in:  
FBS (Flat Black Steel) and SWS (Satin Steel) finishes.

#### BASTOGNE KNOB

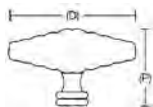

FBS	Code	D	P	List/ea
Flat Black Steel	76017-	2-3/8"	1-1/2"	\$ 13
	76018-	3-3/8"	2"	14

#### FLANDERS KNOB



SWS	Code	D	P	List/ea
Satin Steel	76011-	1-1/4"	2"	\$ 12
	76012-	1-1/2"	2-1/8"	13
	76042-	2"	2-1/2"	17

#### BRITTANY KNOB



FBS	Code	D	P	List/ea
Flat Black Steel	76015-	1"	1-1/8"	\$ 8
	76016-	1-1/4"	1-3/8"	11
	76043-	1-3/4"	1-3/4"	15

#### PETAL KNOB



SWS	Code	D	P	List/ea
Satin Steel	76013-	1"	1-1/4"	\$ 8
	76014-	1-1/4"	1-3/8"	11
	76044-	1-3/4"	1-1/2"	15

#### NORMANDY PULL

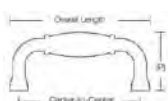

FBS	Code	C/C	O/A	P	List/ea
	76027-	3"	3-1/2"	1-1/2"	\$ 11
	76023-	3-1/2"	4"	1-1/2"	12
	76024-	4"	4-1/2"	1-1/2"	13
	76046-	6"	6-1/2"	1-1/2"	14

### Wrought Steel cont.

#### SAN CARLOS PULL



Code	C/C	O/A	P	List/ea
76026-	3"	3-1/4"	1-1/2"	\$ 11
76021-	3-1/2"	3-3/4"	1-1/2"	12
76022-	4"	4-1/4"	1-1/2"	13
76045-	6"	6-1/4"	1-1/2"	14

#### LAFAYETTE PULL

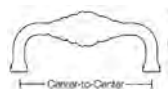

Code	C/C	O/A	P	List/ea
76025-	3"	3-3/8"	1-1/2"	\$ 12
76019-	3-1/2"	3-7/8"	1-1/2"	13
76020-	4"	4-3/8"	1-1/2"	14
76047-	6"	6-3/8"	1-1/2"	15

### Stainless Steel

#### BAR KNOB



Code	D	P	List/ea
S62001SS	2"	1-1/4"	\$ 12

#### DELTA PULL



Code	C/C	O/A	P	List/ea
S60030SS	3"	3-1/2"	1"	\$ 28
S60035SS	3-1/2"	4"	1"	32
S60040SS	4"	4-1/2"	1"	33

#### BAR PULLS

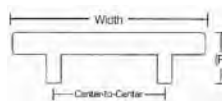

Code	C/C	O/A	List/ea
S62002SS	3"	5"	\$ 14
S62003SS	3-1/2"	5-1/2"	15
S62004SS	4"	6-1/2"	17
S62005SS	5"	7-1/2"	19
S62006SS	6"	8-1/2"	21
S62007SS	8"	10-1/2"	23
S62008SS	10"	12-1/2"	26
S62009SS	12"	14-1/2"	32
S62010SS	16"	18-1/2"	37
S62011SS	24"	26-1/2"	47
S62012SS	28"	30-1/2"	53
S62013SS	32"	34-1/2"	58
S62014SS	36"	38-1/2"	64

P = 1-1/4"  
all pulls

5



## Appliance Pulls

All Special Order  
Lead time 7-10 business days\*



### Solid Brass Finish Options



US4  
Satin Brass



US10B  
Oil R Bronze



US14  
Pol Nickel



US15  
Sat Nickel



US19  
Flat Black



US26  
Pol Chrome

### JASPER



US4

Optional Mounting	Code	C/C	O/A	P	List/ea	BTB List
CS or BTB	86693-	12"	13-3/8"	1-7/8"	\$ 196	\$ 392
CS or BTB	86694-	18"	19-3/8"	1-7/8"	286	572

### WESTWOOD



US10B

Optional Mounting	Code	C/C	O/A	P	List/ea	BTB List
CS or BTB	86912-	12"	13"	2-1/8"	\$ 196	\$ 392
CS or BTB	86913-	18"	19"	2-1/8"	286	572

### WARWICK



US26

Optional Mounting	Code	C/C	O/A	P	List/ea	BTB List
CS or BTB	86711-	12"	12-1/2"	1-3/4"	\$ 196	\$ 392
CS or BTB	86712-	18"	18-1/2"	1-3/4"	286	572

### TRIBECA



US14

Optional Mounting	Code	C/C	O/A	P	List/ea	BTB List
CS or BTB	87005-	12"	15"	2-1/8"	\$ 196	\$ 392
CS or BTB	87006-	18"	21"	2-1/8"	286	572

### KEATON



US15

Optional Mounting	Code	C/C	O/A	P	List/ea	BTB List
CS or BTB	86721-	12"	12-1/2"	1-3/4"	\$ 196	\$ 392
CS or BTB	86722-	18"	18-1/2"	1-3/4"	286	572

### ALEXANDER



US15

Optional Mounting	Code	C/C	O/A	P	List/ea	BTB List
CS or BTB	86442-	12"	13"	2"	\$ 196	\$ 392
CS or BTB	86443-	18"	19"	2"	286	572

### FREESTONE



US15

Optional Mounting	Code	C/C	O/A	P	List/ea	BTB List
CS or BTB	87001-	12"	14"	2"	\$ 196	\$ 392
CS or BTB	87002-	18"	20"	2"	286	572

### TRINITY



US4

Optional Mounting	Code	C/C	O/A	P	List/ea	BTB List
CS or BTB	86444-	12"	15"	2-1/8"	\$ 196	\$ 392
CS or BTB	86445-	18"	21"	2-1/8"	286	572

### MOD HEX



US19

Optional Mounting	Code	C/C	O/A	P	List/ea	BTB List
CS or BTB	87003-	12"	14-3/4"	2"	\$ 196	\$ 392
CS or BTB	87004-	18"	20-5/8"	2-1/8"	286	572

### TRAIL



US19

Optional Mounting	Code	C/C	O/A	P	List/ea	BTB List
CS or BTB	86440-	12"	13"	2"	\$ 196	\$ 392
CS or BTB	86441-	18"	19"	2"	286	572

### BAR PULL



US10B

Optional Mounting	Code	C/C	O/A	P	List/ea	BTB List
CS or BTB	86351-	12"	15-1/4"	2"	\$ 196	\$ 392
CS or BTB	86352-	18"	21-1/4"	2"	286	572

### BAUHAUS



US26

Optional Mounting	Code	C/C	O/A	P	List/ea	BTB List
CS or BTB	86345-	12"	12-5/8"	1-7/8"	\$ 196	\$ 392
CS or BTB	86346-	18"	18-5/8"	1-7/8"	286	572

Standard Mounting

Optional Mounting

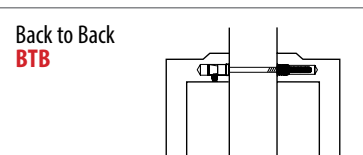
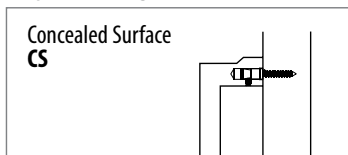

### How To Order:

CS or BTB 86721 US4  
 Concealed Surface or Back to Back Optional Mounting. Leave Blank for Standard Mounting. Finish Product Code



## KNOBS AND PULLS

### ROCKY MOUNTAIN CABINET HARDWARE All Special Order

All made of Solid Art Grade Bronze. Price is the same for all twelve finishes. See page 217 for full range of Rocky Mountain Patina Bronze Finishes. More designs at rockymountainhardware.com.

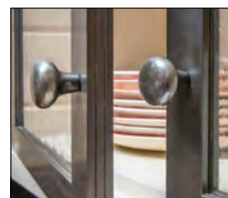

Mushroom Knob	Code	Dia	Proj	List
	CK313	3/4"	13/16"	\$ 52
	CK305	1-1/16"	1-1/4"	54
	CK314	1-3/16"	1-1/4"	57
	CK315	1-3/8"	1-1/4"	57
	CK306	1-5/8"	1-9/16"	63

### Wire Pull



Code	C/C	List	Code	C/C	List
CK333	3"	\$ 60	CK340	4"	\$ 66
CK335	3-1/2"	64	CK308	5"	70

### Egg Knob



Code	W x H	List
CK304	7/8" x 1-1/8"	\$ 57
CK303	1-1/8" x 1-3/8"	60

### Potato Knob



Code	W x H	List
CK302	15/16" x 1-9/16"	\$ 57
CK301	1-1/8" x 1-15/16"	63

### Twig Pull



Code	C/C	List	Code	C/C	List
CK320	2"	\$ 61	CK324	4"	\$ 81
CK319	2-3/4"	69	CK325	5"	84
CK321	3"	70	CK327	7-1/2"	108
			CK330	10"	116

### Barre Knob



Code	L x Proj	List
CK10070	1-3/4" x 1-3/8"	\$ 59

### Shift Knob



Code	W x H	List
CK20225	1-1/16" x 9/16"	\$ 66

### Olympus Pull



Code	C/C	List	Code	C/C	List
CK349	4"	\$ 64	CK350	6"	\$ 73
CK353	5"	69	CK355	10"	99

### Roswell Knob



Code	Dia	List
CK252	1-1/4"	\$ 53
CK254	1-7/16"	57
CK253	1-11/16"	60

### Square Knob



Code	Dia	List
CK223	5/8"	\$ 52
CK225	1-3/16"	57
CK230	1-5/8"	64

### Shift Pull



Code	C/C	List	Code	C/C	List
CK20210	3-1/2"	\$ 117	CK20215	5-9/16"	\$ 142

### Barre Pull



Code	C/C	List	Code	C/C	List
CK10074	4"	\$ 64	CK10076	6"	\$ 73
			CK10078	8"	79

## KNOBS AND PULLS



### ROCKY MOUNTAIN CABINET HARDWARE *Continued...*

More designs at rockymountainhardware.com. Hand made in the USA. All Special Order.

#### Marrakesh Knob



Code	W x H	List
CK20400	1-5/8" x 1-1/2"	\$ 59

#### Marrakesh Pull



Code	C/C	O/A	Proj	List
CK20403	3"	3-15/16"	3/4"	\$ 105

#### Zeppelin Knob



Code	L x Proj	List
CK10040	2" x 1-3/8"	\$ 59

#### Zeppelin Pull



Code	C/C	O/A	Proj	List
CK10044	4"	5-1/16"	1-5/16"	\$ 64
CK10046	6"	7-1/16"	1-5/16"	73
CK10048	8"	9-1/16"	1-5/16"	79

#### Fleur de Lis Knob



Code	W x H	List
CK234	1" x 1-5/8"	\$ 57

#### Catch Pull

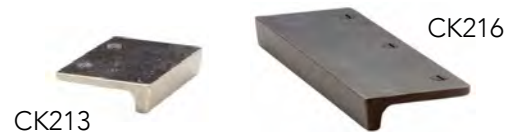

Code	L	Proj	Ht	List
CK213	3"	2-1/8"	5/8"	\$ 72
CK216	6"	2-1/8"	5/8"	94
CK212	12-1/16"	2-1/8"	5/8"	102

#### Brut Knob



Code	Dia	List
CK20010	1"	\$ 71
CK20013	1-3/8"	80

#### Rail Pull



Code	C/C	List	Code	C/C	List
CK258	4"	\$ 65	CK261	9"	\$ 93
CK259	5"	76	CK262	12"	96
CK260	6"	80	CK264	15"	105

#### Organic Square Pull



Code	C/C	O/A	Ht	Proj	List
CK266	7/8"	1-1/4"	5/8"	1-1/4"	\$ 58
CK268	2-5/8"	3"	5/8"	1-1/4"	66
CK270	5-5/8"	6"	5/8"	1-1/4"	83

#### Sash Pull



Code	C/C	List	Code	C/C	List
CK317	3"	\$ 57	CK318	4"	\$ 71
CK310	3-5/8"	60	CK311	6"	75



## COLONIAL BRONZE

## KNOBS AND PULLS



This page show a few of the cabinet hardware items available from Colonial Bronze. To see the complete selection please visit colonialbronze.com.

**Special Order Only** Colonial Bronze will produce any of their items in any finish. Because of this versatility, most items are made-to-order. Please allow 3-4 weeks lead time for most orders.

### All Solid Brass / Hand Finished

#### Finishes

When ordering, please use standard U.S. finish symbols. We will accept and ship all orders using BHMA standards for materials and finishes. Below are just a few examples of Colonial Bronze finishes - visit colonialbronze.com for more.

Please pay particular attention to ordering requirements when specifying finishes for all split-finish items. The part that attaches to the door or drawer is listed first. For example: US3 x US26 for split finish pieces.

US Finish	BHMA Finish	Price Category	Finish Description
US26	625	1	Polished Chrome
US26D	626	1	Satin Chrome
US4	606	1	Satin Brass
US15	619	1	Satin Nickel
US3	605	2	Polished Brass
US5	609	2	Ant. Satin Brass
US10B	613	2	Oil R Bronze
US11	-	2	Ant. Copper
US14	618	2	Polished Nickel
US15B	620	2	Pewter
US15CC	-	2	Nickel Stainless
US19	622	2	Satin Black

Knobs Packed: 10 ea/ Ctn.



Mushroom Knob

Code	Dia	Proj	1	2
190	3/4"	3/4"	\$ 9.31	\$ 11.32
191	1"	1"	13.42	16.38
124	1-1/8"	1-1/8"	10.14	12.43
192	1-1/4"	1-1/4"	16.10	19.42
193	1-1/2"	1-1/2"	23.52	28.78



Oval Knob

Code	Dia	Proj	1	2
198	1" x 1-1/4"	1-3/8"	\$ 24.94	\$ 30.47
199	1-1/4" x 1-1/2"	1-5/8"	33.26	40.67



Code	Dia	Proj	1	2
141	1/2"	1"	\$ 13.04	\$ 15.94
142	3/4"	1-1/8"	15.99	19.56
143	1"	1-1/4"	20.00	24.48



Code	Dia	Proj	1	2
170	3/4"	3/4"	\$ 8.31	\$ 10.16
171	1-1/8"	1"	15.08	18.47
172	1-1/2"	1-3/8"	22.83	27.92



Code	C/C	Proj	O/A	1	2
661	3"	15/16"	3-3/8"	\$ 18.47	\$ 22.61
662	3-1/2"	15/16"	3-7/8"	19.88	24.15
663	4"	15/16"	4-3/8"	21.08	25.80



Proj: 1-3/16"  
Dia: 5/16"

Code	C/C	O/A	1	2
750	2-1/2"	2-3/16"	\$ 7.81	\$ 9.50
751	3"	3-5/16"	8.83	10.80
752	3-1/2"	3-13/16"	9.94	12.12
753	4"	4-5/16"	10.59	12.96
754	5"	5-5/16"	11.45	14.01
755	6"	6-5/16"	14.08	17.25



## CONTINUOUS PULLS

### MARCO CONTINUOUS OAK PULLS - 8' Lengths

Marco Continuous Oak Pulls are made of clear unfinished Red Oak. 8' Lengths. Fits 3/4" Drawer Fronts.

40 ea/ Ctn.

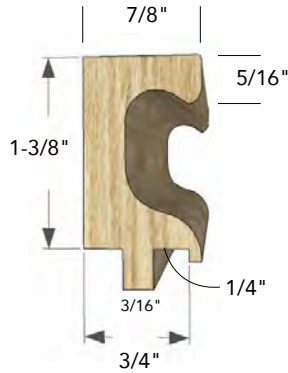
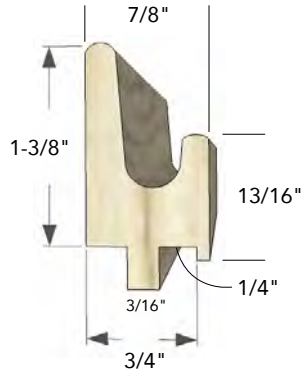

Code	Description	List/ea
CPC3-8-OAK	"C" Pull, for 3/4" Fronts, Oak	\$ 27.59
CPC3-8-MAP	"C" Pull, for 3/4" Fronts, Maple	35.95
CPJ3-8	"J" Pull, For 3/4" Fronts	28.30

### 8' CONTINUOUS PULLS

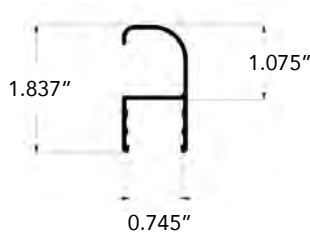

Pressure fitting continuous pull, for push fit on material with thickness of 3/4". Ideal for both vertical and horizontal applications, to run entire length of door or drawer.

Code	Finish	List/ea
OA6920-8A	Clear Anodized Aluminum	\$ 58.23
PC63-96BP	Black Powder Coat	84.75

### EPCO ARCHITECTURAL DRAWER PULLS

Surface Mounted

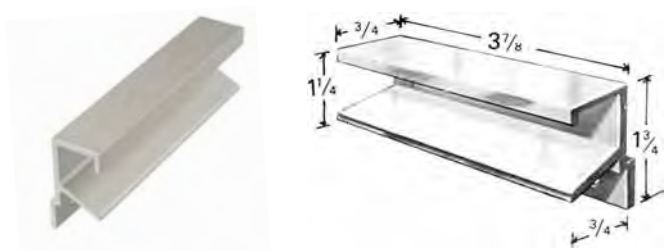

For 3/4" thick Panels. 3-7/8" and 6' Lengths. Anodized Aluminum. Mounts flush into 1-1/4" Height x (L = Length) cutout.

Code	Length	Ctn	List/ea
DP46LA	6' L, No Holes	10	\$ 75.44

### EPCO ARCHITECTURAL DRAWER PULLS

Extruded

Extruded Handles, Anodized Aluminum, in 6' lengths. For 3/4" material. Saw Kerf: 1/8".

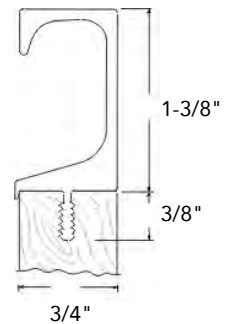

Code	Description	Ctn	List/ea
DP419LA	6' L, Extruded, Anodized Aluminum	10 ea	\$ 68.00

## GOLA CONTINUOUS PULLS

# GOLA Cabinet Profiles

### Horizontal Profiles

Tool-less attachment to Cabinet with Support & H Clip. Matching Closed End Caps available.

#### 'L' Profile

Stainless Steel & Black finishes.

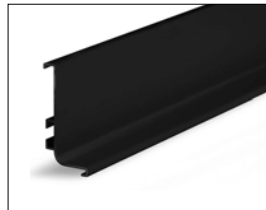

8006-ST

CEC8006  
 Closed End Caps  
 for 'L' profile

#### Code

8006-ST

#### Description

'L' Profile pull, Stainless Steel,  
 27mm W x 56mm H x 4000mm L

#### List

\$ 141.54/ea

8006-BLK

'L' Profile pull, Black,  
 27mm W x 56mm H x 4000mm L

143.94

8007-ST

'C' Profile pull, Stainless Steel,  
 26mm W x 72.7mm H x 4000mm L

176.84

8007-BLK

'C' Profile pull, Black,  
 26mm W x 72.7mm H x 4000mm L

179.35

CEC8006-ST

End Cap for 'L' profile, St Steel

22.66/st

CEC8006-BLK

End Cap for 'L' profile, Black

24.26

CEC8007-ST

End Cap for 'C' profile, St Steel

19.53

CEC8007-BLK

End Cap for 'C' profile, Black

24.23

GFXKIT-S

Supports for 8006, 8007  
 2 kits needed per each 'run'

1.88

#### 'C' Profile

Stainless Steel & Black finishes.



8007-ST

shown w/ closed end caps

8007-BLK

CEC8007  
 Closed End Caps  
 for 'C' profile

Attach to Cabinet with **Support & H Clip.**



**Support Kit**  
 GFXKIT-S

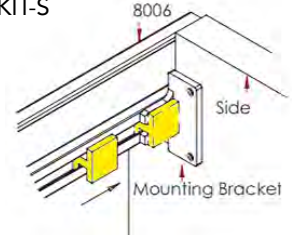
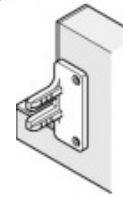

### Upper Cabinet Profiles

Create a Fingerhold for any drawer or cabinet meant to be opened from underneath. Available in Stainless Steel.

3/4" H x 13/16" D x  
 8.86' (2700mm) Length



1730-ST



#### Code

1730-ST

#### Description

Upper Cab pull, 8.86'

#### Finish

St Steel

#### List/ea

\$ 81.52

## EDGE PULLS

## TYDIX PULLS

### TYDIX PULLS - All Special Order Solid Brass

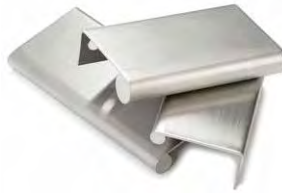

Please State the following information when ordering:

1. Desired Type (i.e., SR, SF, or SRO).
2. Roll Diameter: 1/4", 5/16", 3/8" or 1/2" are standard available roll diameters
3. Roll Length: 1-1/2" through 6"-- standard through 18"-- special
4. Thickness of Basic Drawer or Door (Screws will be located accordingly)
5. Thickness of any overlay (mirror, panel, etc.)
6. Clearance (if other than 1/2" std.)
7. Overall Dimension (OA) if important
8. Finish

**NOTE: IT WOULD BE VERY HELPFUL TO INCLUDE A SKETCH**

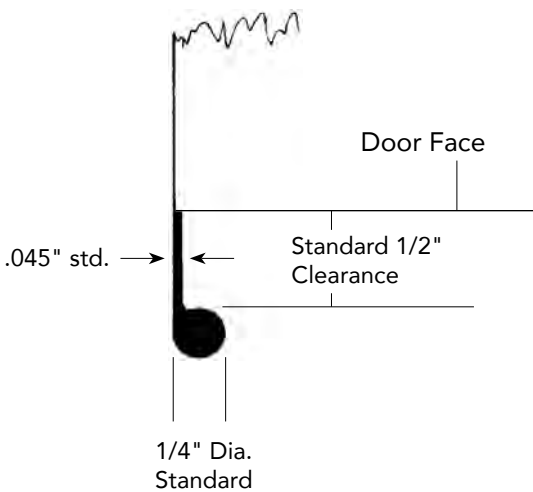

### SF Pull

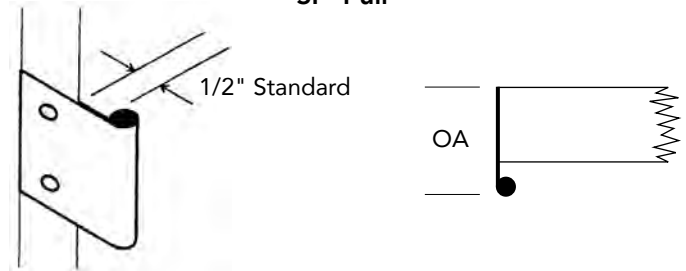

### SR Pull

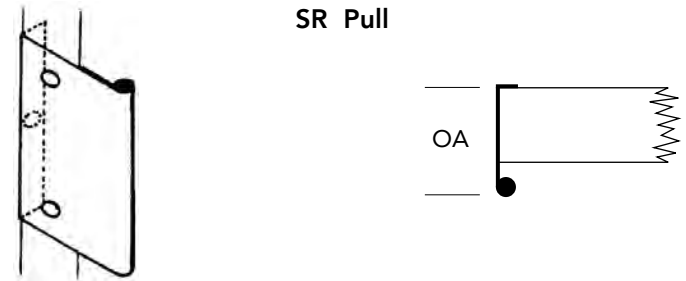

### SRO Pull

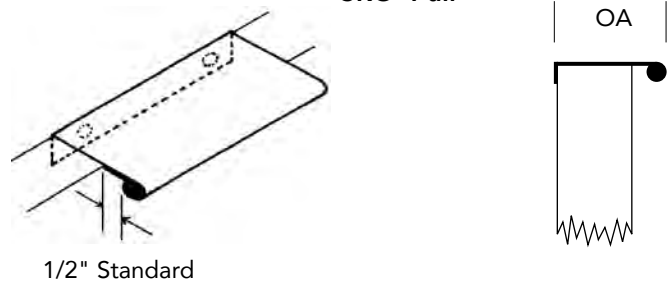

Type	Roll Dia x Length	Drawer Thickness	Finish	List/ea
SF	1/4" x 1-1/2"	3/4"	3, 26, 26D, 14	\$ 86.98
SF	1/4" x 1-1/2"	3/4"	9, 10, 10B, 15	86.98
SR	1/4" x 1-1/2"	3/4"	3, 26, 26D, 14	86.98
SR	1/4" x 1-1/2"	3/4"	9, 10, 10B, 15	86.98
SRO	1/4" x 1-1/2"	3/4"	3, 26, 26D, 14	86.98
SRO	1/4" x 1-1/2"	3/4"	9, 10, 10B, 15	86.98

Other Roll Diameters and Lengths are available - Call for Quote.  
 For Rounded Roll Ends specify "RC" and add \$ 1.20 to List price.

## TYDIX PULLS

### TYDIX FLUSH PULLS

All Special Order

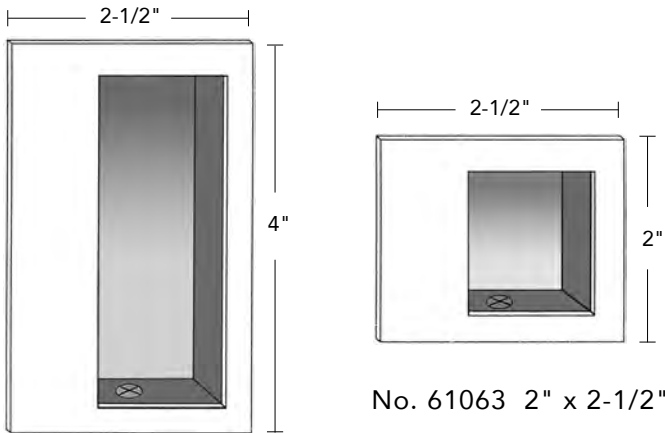

No. 61064 4" x 2-1/2"

### SINGLE PULL FOR DOORS & DRAWERS

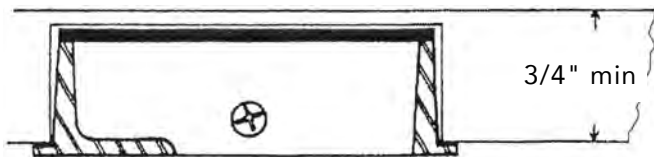

### TWO PULLS -- ONE DOOR

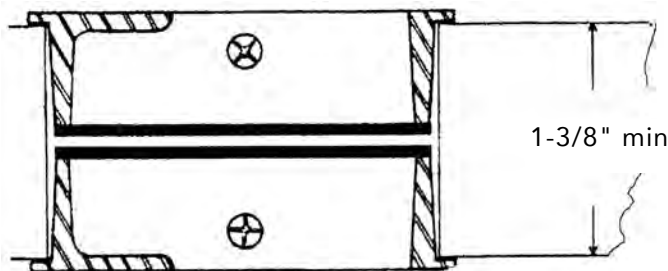

## FLUSH PULLS

### TYDIX FLUSH PULLS

All Special Order

#### TO ORDER, SPECIFY THE FOLLOWING:

1. Flush Pull Number
2. Finish of Face
3. Color Inside (Black is standard)
4. Backplate Color (Black is standard)

#### TAMPERPROOF SCREWS:

Specify "TMP" and add \$ 1.32 list

#### TYDIX FLUSH PULL PRICING

(Other Finishes are Available - Call for Price)

Code	Face Finish	Inside Finish	List/ea
61063 US3XBLK	Pol Brass	Black	\$ 159
61063 US26XBLK	Pol Chrome	Black	138
61063 US26DXBLK	Dull Chrome	Black	138
61063 US10BXBLK	Oil R Bronze	Black	138
61064 US3XBLK	Pol Brass	Black	174
61064 US26XBLK	Pol Chrome	Black	168
61064 US26DXBLK	Dull Chrome	Black	168
61064 US10BXBLK	Oil R Bronze	Black	168





## TAB PULLS

### MOCKETT TAB DRAWER PULLS



Made of handcast steel. 1/ Ctn.

Proj: 1-1/2"  
Ht: 3/4"

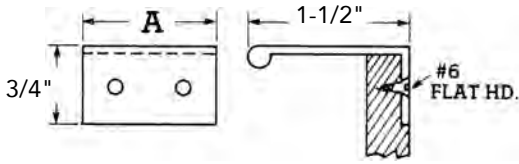

Code	Finish	A (Length)	List/ea
DP3-21	Black Chrome	1-1/4"	\$ 22.46
DP3-26	Pol Chrome	1-1/4"	21.18
DP3-17	Satin Nickel	1-1/4"	25.08
DP3A-26	Pol Chrome	3"	30.62
DP3A-3	Pol Brass	3"	33.39
DP3A-17	Satin Nickel	3"	37.57
DP3B-26	Pol Chrome	4"	31.00
DP3B-17	Satin Nickel	4"	37.75

### TOP KNOBS EUROPA TAB PULLS

Zinc Alloy. Proj: 1-5/8".



Code	Finish	Length	C/C	List/ea
TK500BLK	Flat Black	1-1/4"	5/8"	\$ 6.58
TK500BSN	Brushed Sat Nickel	1-1/4"	5/8"	6.49
TK500PC	Pol Chrome	1-1/4"	5/8"	6.42
TK501BLK	Flat Black	3"	2"	10.72
TK501BSN	Brushed Sat Nickel	3"	2"	10.93
TK501PC	Pol Chrome	3"	2"	10.71
TK502BLK	Flat Black	4"	3"	13.75
TK502BSN	Brushed Sat Nickel	4"	3"	13.93
TK502PC	Pol Chrome	4"	3"	13.56
TK503BLK	Flat Black	6"	5"	15.57
TK503BSN	Brushed Sat Nickel	6"	5"	15.57
TK503PC	Pol Chrome	6"	5"	13.56

### SUGATSUNE STAINLESS STEEL TAB PULL



Made of 18-8 Stainless Steel.  
Supplied with stainless steel screws.  
1-1/2" Projection, 11/16" Height.

S: Satin Finish

M: Mirror Finish

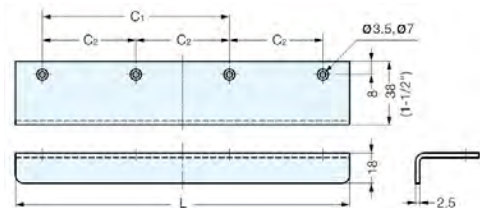

Code	L	C1	C2	Hole	Satin	Mirror
SN50S / M*	50 (1-31/32")	30 (1-3/16")	-	2	\$ 9.00	\$ 9.49
SN70S / M	70 (2-3/4")	46 (1-13/16")	-	2	9.81	11.42
SN95S / M*	95 (3-47/64")	65 (2-9/16")	-	2	12.74	14.44
SN120S / M*	120 (4-23/32")	90 (3-35/64")	45	3	14.66	17.17
SN150S / M*	150 (5-29/32")	114 (4-31/64")	57	3	20.32	22.32

\*Special Order



## FLUSH PULLS

### FORMS + SURFACES TAB PULLS - Special Order

Made of extruded aluminum.  
Anodized finish. Projection: 1".  
10 ea/ Ctn.

SC: Satin Clear  
BL: Matte Black



Code	C/C	O/A
HC430- SC/BL	1"	1-1/2"
HC431- SC/BL	1-3/4"	2-1/4"
HC433- SC/BL	3"	3-1/2"

Call for Price

### BAINBRIDGE RECESSED PULL



1710-20BL

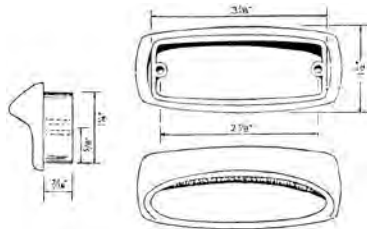

Recessed pull for all applications including lids, drawers, and doors. Plastic.

Size: 3-1/8" x 1-1/2" x 7/16" projection from mounting surface. With screws.

Code	Finish	Ctn	List/ea
1710-20BL	Black	100 ea.	\$ 2.59

### FLUSH MOUNT PLASTIC HANDLES



2867

Screw C to C: 3-3/4"  
260 per ctn.

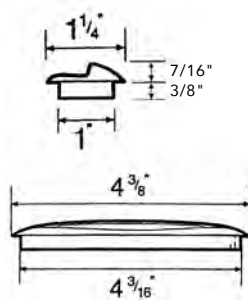

Code	Finish	List/ea
2867-014	Black	\$ 2.12
2867-029*	Almond	2.27

\*disc when out

### KV BRASS FLUSH DRAWER PULL

Beveled edge brass flush drawer pull.  
1-3/4" x 3-1/4" x 9/16" deep, with beveled edges. 12/ box w/ screws.



819X

Code	Finish	Ctn	List/ea
819XPB	Pol. Brass	12	
819XANO	Anochrome	12	

### SUGATSUNE FLUSH PULL - Special Order Stainless Steel & Black

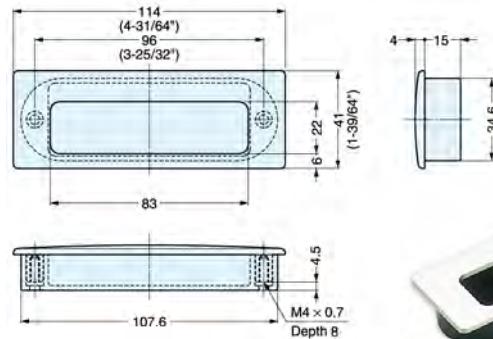

Code	Finish	Ctn	List/ea
HH-K	Mirror, 316 Stainless w/ Black ABS	10	\$ 59.90

### EMTEK FLUSH PULLS Solid Brass

Special Order. Square and Round fit std. 2-1/8" door prep.



Code	Description	List/ea
2213	Square, 2-1/2" x 2-1/2"	\$ 22



2211	Round, 2-1/2" dia.	22
------	--------------------	----



2201	Rectangular, 1-3/4" x 4"	22
------	--------------------------	----

Available finishes: Pol. Brass (US3), Satin Brass (US4), French Ant. (US7), Oil R Brz (US10B), Pol. Nickel (US14), Satin Nickel (US15), Pewter (US151A), Flat Black (US19), Pol. Chm (US26), Med Brz (MB), Tumbled Wht Brz (TWB)



# INSPIRING BEAUTY

Over 3000 products. 30 finishes. Endless possibilities.

5



Sanctuary

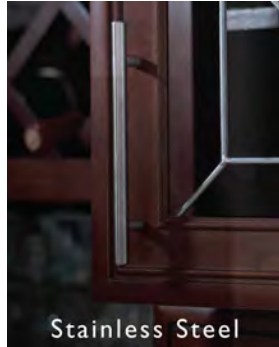

Stainless Steel



Asbury

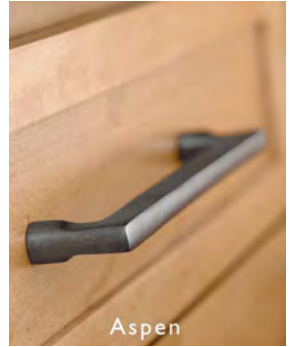

Aspen

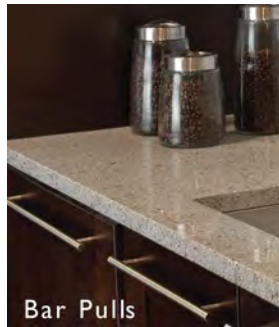

Bar Pulls



Britannia

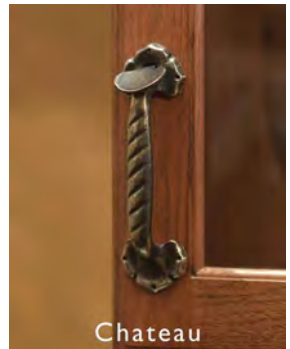

Chateau



Crystal



Dakota

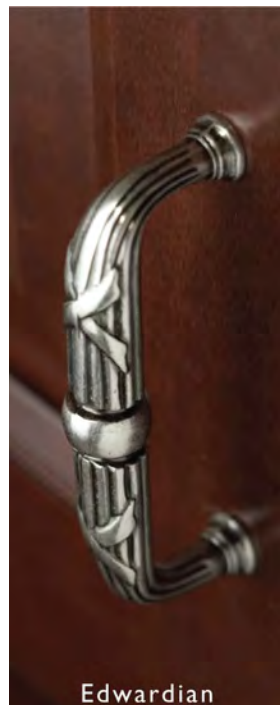

Edwardian



Normandy



Nouveau



Oil Rubbed Bronze



Somerset





# INSPIRING BEAUTY

Over 3000 products. Over 30 finishes. Endless possibilities.

It's all in the details - the right decorative hardware just makes the look. More than an accessory, the hardware is the jewel that draws the eye, accentuates the style and adds elegance to the space it graces. But true beauty goes beyond initial good looks. It's in the style, the depth of the finish and in the weighty feel of the piece in your hand.

5

## FINISHES KEY



**ALU** Aluminum



**GBZ** German Bronze



**PN** Polished Nickel



**AG** Ash Gray



**HB** Honey Bronze



**PT** Pewter



**AC** Antique Copper



**LB** Light Bronze



**PTA** Pewter Antique



**AP** Antique Pewter



**MB** Medium Bronze



**PTL** Pewter Light



**BB** Brushed Bronze



**MCB** Mahogany Bronze



**SAB** Sable



**BI** Black Iron



**OEC** Old English Copper



**SBL** Silicon Bronze Light



**BLK** Flat Black



**ORB** Oil Rubbed Bronze



**SS** Stainless Steel



**BNI** Black Nickel



**PAB** Patina Black



**TB** Tuscan Bronze



**BSN** Brushed Satin Nickel



**PAR** Patina Rouge



**UM** Umbrio



**CI** Cast Iron



**PB** Polished Brass



**DAB** Dark Antique Brass



**PC** Polished Chrome



## APPLIANCE PULLS

## PRIDE

### PRIDE APPLIANCE PULLS - 8" & 12" C/C

Available in Matte Black, Rose Gold and Satin Nickel



**Miami**

Code	C/C	Finish	Ctn	List/ea
P-A5108-BK	8"	Matte Black	50	\$ 14.86
P-A5108-RG	8"	Rose Gold	50	17.14
P-A5108-SN	8"	Satin Nickel	50	16.53
P-A51012-BK	12"	Matte Black	20	60.96
P-A51012-RG	12"	Rose Gold	20	69.05
P-A51012-SN	12"	Satin Nickel	20	66.93

### PRIDE APPLIANCE PULLS - 8" & 12" C/C

Available in Matte Black, Rose Gold and Satin Nickel



**Colorado**

Code	C/C	Finish	Ctn	List/ea
P-A5408-BK	8"	Matte Black	50	\$ 22.04
P-A5408-RG	8"	Rose Gold	50	24.97
P-A5408-SN	8"	Satin Nickel	50	24.26
P-A54012-BK	12"	Matte Black	20	59.65
P-A54012-RG	12"	Rose Gold	20	66.52
P-A54012-SN	12"	Satin Nickel	20	64.55

5



**Charlotte**

Code	C/C	Finish	Ctn	List/ea
P-A5208-BK	8"	Matte Black	50	\$ 19.87
P-A5208-RG	8"	Rose Gold	50	22.85
P-A5208-SN	8"	Satin Nickel	50	22.14
P-A52012-BK	12"	Matte Black	20	46.81
P-A52012-RG	12"	Rose Gold	20	53.03
P-A52012-SN	12"	Satin Nickel	20	61.92



**Modern Square**

Code	C/C	Finish	Ctn	List/ea
P-A5608-BK	8"	Matte Black	50	\$ 18.70
P-A5608-RG	8"	Rose Gold	50	21.64
P-A5608-SN	8"	Satin Nickel	50	20.93
P-A56012-BK	12"	Matte Black	20	86.04
P-A56012-RG	12"	Rose Gold	20	93.47
P-A56012-SN	12"	Satin Nickel	20	91.70



**Manhattan**

Code	C/C	Finish	Ctn	List/ea
P-A5308-BK	8"	Matte Black	50	\$ 19.87
P-A5308-RG	8"	Rose Gold	50	22.75
P-A5308-SN	8"	Satin Nickel	50	22.04
P-A53012-BK	12"	Matte Black	20	56.21
P-A53012-RG	12"	Rose Gold	20	63.74
P-A53012-SN	12"	Satin Nickel	20	61.92



**Vail**

Code	C/C	Finish	Ctn	List/ea
P-A5508-BK	8"	Matte Black	50	\$ 18.10
P-A5508-RG	8"	Rose Gold	50	21.08
P-A5508-SN	8"	Satin Nickel	50	20.47
P-A55012-BK	12"	Matte Black	20	63.10
P-A55012-RG	12"	Rose Gold	20	71.58
P-A55012-SN	12"	Satin Nickel	20	69.61

\*See other Appliance Pulls on pgs. 515 (Amerock) and 545 (Emtek)



## TOUCH LATCHES

### MAGNETIC TOUCH LATCH

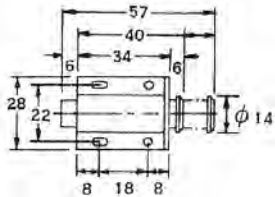

Individually polybagged with wood strike and screws.  
Overall dimensions: 1-5/8" x 1-1/8".

Code	Description	Ctn	List/bg
50703-WH	White Plastic	20 bgs.	\$1.60
50703-BL	Black Plastic	20	1.83

### DOUBLE MAGNETIC TOUCH LATCH

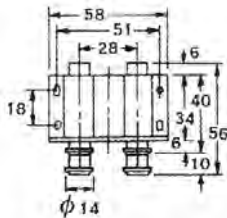

Individually polybagged with wood strike and screws.  
Overall dimensions: 2-1/4" x 1-7/8".

Code	Description	Ctn	List/bg
50723-WH	White Plastic	20 bgs.	\$ 3.06
50723-BL	Black Plastic	20	4.12

### TOUCH LATCH STRIKE for Glass Doors



Length: 1-9/16"  
Height: 15/16"

Code	Finish	Ctn	List/ea
50020-BLK	Black	100 ea.	\$ 1.90
50020-PC	Chrome	100	1.90

### AMEROCK TOUCH LATCH

3 to 6 lbs. magnetic holding force.  
Screws included.



Code	Color	Ctn	List/ea
BP32301-BR	Brown Plastic	25 ea.	\$ 7.27
BP32301-W	White Plastic	25	7.27

### MAGNETIC TOUCH LATCHES

Sugatsune

#### ML30S

Pull force: 2.6 lbs.



Push to open/close. For overlay door, allow a 4mm (5/32") gap between door and cabinet frame for pushing room. Add .33" to length for stroke.

Code	Description	List/ea
ML30S-WH	Mag Touch Latch, White	\$ 3.64
ML30S-BR	Mag Touch Latch, Brown	3.64

#### ML80

Pull force: 3.5 lbs.

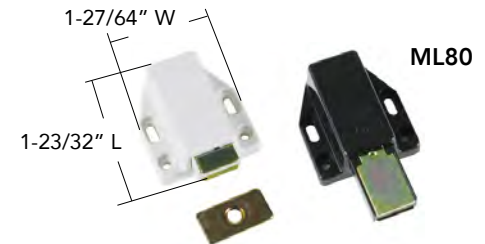

Push to latch/unlatch. For overlay door, allow a 3.5mm (9/64") gap between door and cabinet frame for pushing room. With strikes and screws.

Code	Description	List/ea
ML80W	Mag Touch Latch, White	\$ 4.55
ML80BL	Mag Touch Latch, Black	5.86
ML80BR	Mag Touch Latch, Brown	4.75

### ML120 w/ Long Stroke for Inset Doors. Pull force: 5.2 lbs.

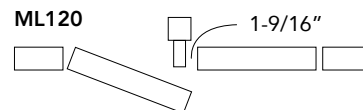
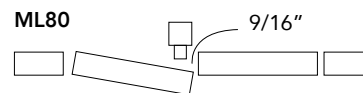

1-13/16" W x 2.97" L  
Add 1.57" to L for stroke.

Push to latch/unlatch. Long stroke (40mm/1.57") for medium size doors. For overlay door, allow a 3.5mm (9/64") gap between door and cabinet frame for pushing room.

Code	Description	List/ea
ML120WH	Mg Touch Latch, White, Long stroke	\$ 8.09
ML120BR	Mg Touch Latch, Brown, Long stroke	8.09
ML120BL	Mg Touch Latch, Black, Long stroke	8.09

## TOUCH LATCHES

### TOUCH LATCH

Sugatsune

MC37  
 Safe Push Latch

2-1/4" Length x  
 1-9/16" Width



MC37WH MC37BR MC37BL

Push to latch/unlatch. The MC37 offers a distinct safety advantage over other magnetic latches because it cannot be pulled open. Floating strike allows for easy alignment. For overlay door, allow 3mm (1/8") gap between door and cabinet frame for push space.

Strong retaining force: 17.6 lbs. Screws included.

Code	Description	Ctn	List/ea
MC37WH	Touch Latch, White	30 ea.	\$ 7.68
MC37BL	Touch Latch, Black	30	7.68
MC37BR	Touch Latch, Brown	30	7.68

### TOUCH LATCH

Sugatsune

Push to latch/unlatch. Floating strike allows for easy alignment. For overlay door, allow 3mm (1/8") gap between door and cabinet frame for push space. Retaining force: 6.6 lbs. Black in color.



Code	Description	Ctn	List/ea
MC-28-BLK	Touch Latch, Black	50 ea.	\$ 6.47

### MINI TOUCH LATCH

Epcó

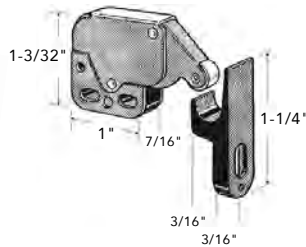

Steel and plastic case. Plastic strike. Polybagged with strike and screws.

Code	Finish	Ctn	List/ea
505-BP	Brass/Brown	10	\$ 5.22
505-NP	Nickel/White	10	5.64

### SALICE PUSH SYSTEM - Hands Free Opening

See page 745 for more details



Hinge springs opens 34° when door is pushed in.

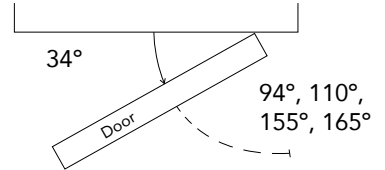
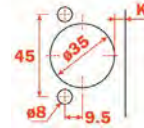

### Mechanical



**DP29SNBR**  
 Beige Surface Push Catch



**DP29SN3R**  
 Black Surface Push Catch



**DP29SNB**  
 Beige Recessed Push Catch



**DP29SN3**  
 Black Recessed Push Catch



**DP4SNB** - Beige  
**DP4SN3** - Black  
 Release Device & Retaining Catch

### Magnetic



**DPMSNB**  
 Release Device

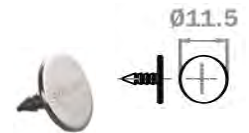
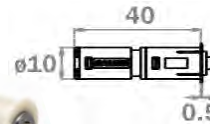

**DP28SN9**  
 Mag plate w/ nail

### **DP39XXG** Adjustable Magnetic Strike Plate



Inserts into door. Increases holding power and is ideal for larger, heavier doors. Features depth adjustment which enables precise alignment between the door and the magnet and can compensate for the possible bowing of the door.

Code	Description	List
DP29SNBR	Beige Surface Push Catch	\$ 1.25/ea
DP29SN3R	Black Surface Push Catch	1.22
DP29SNB	Beige Recessed Push Catch	.64
DP29SN3	Black Recessed Push Catch	.55
DP4SNB	Beige Push Release Device	7.48
DP4SN3	Black Push Release Device	7.88
DP39XXG	Adjustable Mag strike plate	8.99
DPMSNB	Magnetic Release Device	10.49
DP28SN9	Mag plate w/ nail for DPMSNB	15.43/C



## PUSH LATCHES



### PUSH-TO-OPEN DOOR LATCH - 11 lb Push



Durable magnetic metal touch latch with strong push force for full size doors eliminates the need for handles. Create hidden doors in closets, pantries and other spaces.

Magnetic force: 6.6 lbs.  
Push force: 11 lbs.

- For use on large doors due to its strong push force
- Magnet part has an allowance of 1.5° on each side to catch the strike plate correctly, helping the magnet to adjust even if there is a slight misalignment
- Screws for the mounting plate are designed to be hidden from view

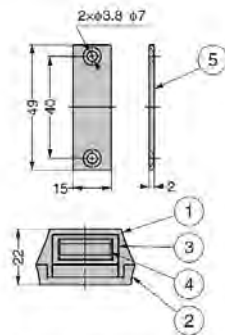
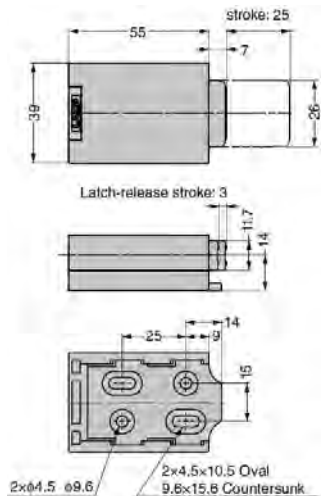

No.	Part Name	Material	Finish/Colour
①	Body	Zinc Alloy (ZDC)	Enamel Finish
②	Mounting Plate	Zinc Alloy (ZDC)	Enamel Finish
③	Latch	Polyamide (PA)	
④	Magnet	Ferrite	
⑤	Strike Plate	Stainless Steel	Barrel Polished

Code	Description	List/ea
ML-ZN80BL	Push-To-Open Mag Latch, Black	\$ 53.58
ML-ZN80WT	Push-To-Open Mag Latch, White	53.58

### TITUS PUSH LATCH SET With Linear Plate

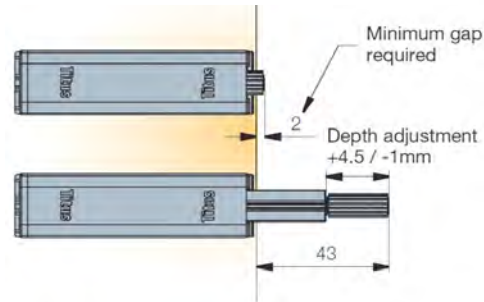

Titus Push Latch Set with Linear Plate. For effortless opening of doors and drawers without handles. Allows for maximum efficiency and flexibility. Designed to be used with standard hinges and drawers: the gap between the drawer and the cabinet side = min. 12mm.

Adjustment button ensures reliable door and drawer opening and closing as well as consistent performance in case of inaccurate drilling. Easy mounting using standard drilling pattern. 'Safety click' feature enables easy detachment of the mechanism from the mounting plate.

- Min Gap: 2mm
- Push out extension: 43mm (1.69")
- Depth adj: +4.5mm/-1mm
- Overall length (unextended): 3-1/16"
- Thickness w/ Plate: 11.2mm (allow 1/2" gap)

Code	Description	List/ea
915K2	Push Latch Set w/ Linear Plate	\$ 8.40

## TOUCH LATCHES

### INVISIBLE LATCH

Ives CL12



CL12

Ideal for installations where no visible latch is desired. Can be installed at the top, bottom, or side of the door. Can be mortised into the stop or surface mounted to the stop. Recommended for use on larger panels or regular size doors. Latch by a slight push. A harder push releases the door. Allow 5/32" push distance to operate.

Brass and plastic construction.  
 Meets ANSI/BHMA A156.9, B03272.

Body: 2-1/4" Tall x 1-1/4" Wide x 7/16" Thick  
 Strike: 1-3/4" Tall x 3/4" Wide

Code	Finish	List/ea
CL12-26D	Dull Chrome	\$ 56.83

### AUXILIARY PUSHER

for CL12 Latch



CL14

- Aids in the operation of the CL12 where hinges or surrounding conditions prevent smooth operation of doors
- Provides 1-1/16" throw
- Nylon pusher
- Brass construction
- Applies 10 lbs. to open the door

Body Dimensions:  
 2-15/16" Long x 1-11/16" Wide x 5/8" Deep

Code	Finish	List/ea
CL14-26D	Dull Chrome	\$ 40.16

### BAINBRIDGE "TOUCH" DRAWER OPENER



1021

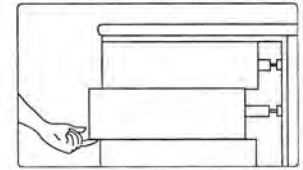
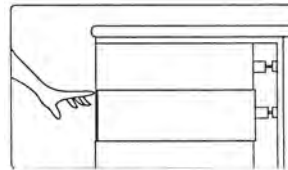
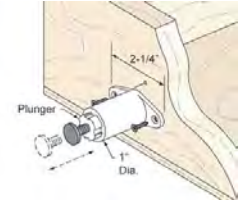

Press Drawer forward 1/8" and Drawer Opens!

Eliminates need for knobs and pulls. Not recommended for self-opening drawers. Can be mounted *through* or *on* back of drawer.

Code	Description	Ctn	List/ea
1021	Touch Drawer Opener	25 ea.	\$ 10.24

### REV-A-LOCK CABINET LOCK

Rev-A-Shelf

Magnetic Lock



The lock is installed internally, leaving the outside design of the cabinet unmarred. A magnetic "key" placed on the outside of the cabinet door releases the lock. Excellent for childproofing a house. Keys and lock are packaged separately.

Code	Description	List/ea
RL-201	Lock w/strike plate	\$ 10.40
RL-202	Magnetic "key"	13.99



## LATCHES

### DELTA CABINET LOCKS

Solid Brass

#### Small Lock:

1-1/8" x 1-13/16"



CL1532

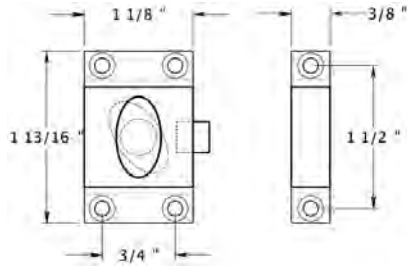

Code	Finish	List/ea
CL1532U10B	Oil R. Bronze	\$ 23.80
CL1532U15	Sat. Nickel	26.65

Other finishes can be special ordered.

### SECRET GATE LATCHES

Designed to restrict entry into fenced off areas in banks, stores, or public buildings. (Handle does not operate a latch.)



#### **KNAPE & VOGT**

Cast Aluminum. 3 per box.

989AL	Alum. Finish	\$ 35.83
-------	--------------	----------

#### **PARKER**

Solid Cast Brass. 1 per box.



551PC	Chrome Plate	\$ 29.18
-------	--------------	----------

## MAGNETIC CATCHES

### AMEROCK MAGNETIC CATCH

For Inset Doors and other applications.  
Packed with three strikes.



BP9765

Case Size: 1-15/16" L x 3/4" W x 11/16" H

Holding Strength: 10 lbs.

#### Three Strikes Included:



Flat Strike  
For 3/8" Inset Door



Inset Strike

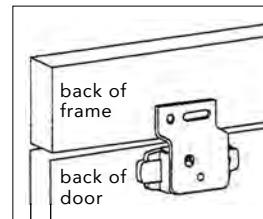

Inset Strike made for inset doors that use the Amerock full inset hinge. When doors and frames are the same thickness, alignment is automatic.

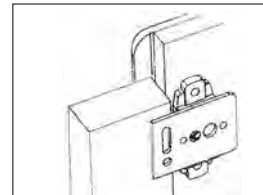

Use flat strike for 3/8" Inset Doors. Will work with all 3/8" door applications.

Polybag contains: 1 ea. magnetic catch, 3 ea. strikes (one of each shown above) and screws.

Code	Color	Ctn	List/ea
BP9765-3PT	Tan	25 ea.	\$ 4.89
BP9765-3W	White	25	6.55



## MAGNETIC CATCHES

### AMEROCK MAGNETIC CATCHES



BP9753

Pull force: 10 lbs.  
Magnetic Housing: Alum w/  
Wood Grain Finish  
9/16"H x 1-1/8"D x 1-15/16"L  
Strike Plate: Zinc  
25 each/box.

BP9753-AW List \$ 3.43 ea.

Pull force: 11 lbs.  
Magnetic Housing: Aluminum  
5/8"H x 1"D x 2"L  
Strike Plate: Steel  
3/4"H x 1-1/8"L  
25 each/box, packed w/screws



BP9783

BP9783-AL List \$ 4.84 ea.



BP3473

Pull force: 10 lbs.  
Magnetic Housing: Tan  
1/2"H x 1-1/8"D x 2"L  
Strike Plate: Zinc  
3/4"H x 1-1/8"L  
25 each/box.

BP3473-PT List \$ 1.82 ea.

Pull force: 19 lbs.  
Magnetic Housing: Alum w/  
Wood Grain Finish  
13/16"H x 1-1/16"D x 2-1/32"L  
Strike Plate: Zinc  
25 each/box.



BP9798

BP9798-AW List \$ 7.97 ea.

### SUGATSUNE MAGNETIC CATCHES

Sealed Magnetic Catch.  
Hermetically sealed, ideal  
for high corrosion resistance.  
Magnetic force: 6.6 lbs.  
Available in white or black.

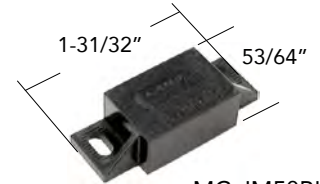

MC-JM50BL

Code	Description	List/ea
MC-JM50WT	Sealed Magnetic Catch, White	\$ 10.62
MC-JM50BL	Sealed Magnetic Catch, Black	10.62

Stainless Steel optional counterplate  
for MC-JM magnetic catches. Ideal  
for applications where rust is an issue.

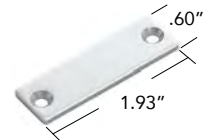

Code	Description	List/ea
MC-JM49	Stainless Steel counterplate	\$ 1.52

Ultra Thin Magnetic Catch.

Design ideal for tight spaces.  
Counterplate included.  
Magnetic force: 5.9 lbs.

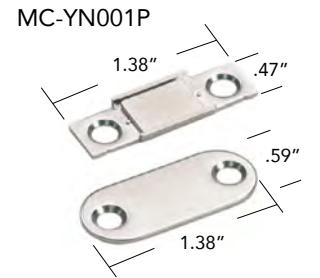

MC-YN001P

Code	Description	List/ea
MC-YN001P	Thin Magnetic Catch	\$ 7.18

Ultra Thin & Strong Magnetic Catch.

Designed with extra strong  
magnetic force. Counterplate  
and fasteners not included.  
Magnetic force: 8.8 lbs.



MC-159

Code	Description	List/ea
MC-159	Strong Magnetic Catch	\$ 4.65
MC-159-PLATE	Strike Plate	.71

6





## MAGNETIC CATCHES

### WHITE MAGNETIC CATCH

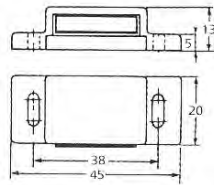

50631

Pull force: 9 lbs. Magnetic Housing: White.  
Strike Plate: Steel chromated. Polybagged with  
screws, 100 bags per carton.

Code	Color	List/bag
50631-WH	White	\$ 2.23

### DOUBLE MAGNETIC CATCH



50620

2-7/8" L x 3/4" W. Pull force: 9 lbs. Magnetic Housing:  
Plastic White or Brown. Strike Plate: Steel chromated.  
Polybagged with screws, 25 bags per carton.

Code	Color	List/bag
50620-WH	White	\$ 2.60
50620-BR	Brown	2.88

### IVES HEAVY DUTY MAGNETIC CATCH

Heavy duty 30 lb. pull.  
Furnished with one large  
strike and two small  
strikes.

Natural Aluminum Finish.  
15 per pack.

SP326A92 List \$ 11.43 ea.

SP326  
30 lb.



### EPCO MAGNETIC CATCHES

Round Magnetic Catch for cabinet doors.  
Pull force: 4 lbs. Fits into 5/8" bore.  
Floating permanent strike. 10/ box.



600EP

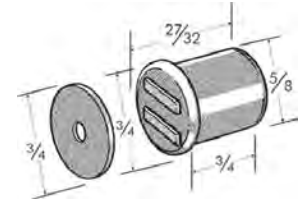

Code	Color	List/ea
600EP	Aluminum	\$ 3.20

Magnetic Catch for cabinet doors. Pull force: 6.5 lbs.  
Aluminum case with lifetime magnet is self-aligning  
to strike plate. Standard duty. 10/ box.



591EP

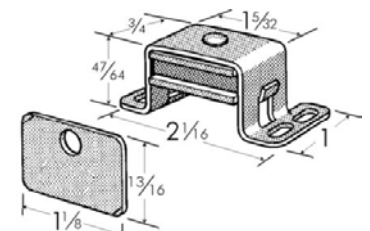

Code	Color	List/ea
591EP	Aluminum	\$ 3.01

Heavy Duty Magnetic Catch for larger doors. Pull  
force: 13 lbs. Aluminum case with lifetime magnet  
is self-aligning to strike plate. Packed with strikes  
& screws.

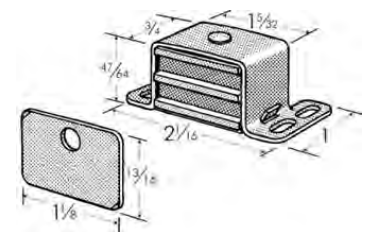

Code	Color	Pack	Ctn	List/ea
592EP	Alum	Polybag	10	\$ 4.43
592-WS	Alum	Bulk	250*	3.51

\*Full Ctns only



## MAGNETIC CATCHES

### IVES MAGNETIC CATCH

Aluminum case, double pole.  
Self-aligning magnet insures  
maximum pull. 50 per pack.



SP325A92  
6 lbs.

Case Size: 2-1/16" x 1-1/8" x 5/8".

Code	Finish	List/ea
SP325A92	Aluminum	\$ 2.85

6

### BELWITH MAGNETIC CATCHES

1-5/8" x 3/4".  
Stat. Bronze.  
25 each box.

P659STB  
4.4 lb.



P659STB List \$ 3.63 ea.

1-3/4" W x 1/2" H  
x 5/8" D  
Brown plastic case.  
25 each box.

P109-2C  
4 lb.



P109-2C List \$ 4.78 ea.

2-1/4" W x 13/16" H  
x 1" D  
Stat. Bronze flanges.  
Brown plastic case.  
25 each box.

P651STB  
6 lb.

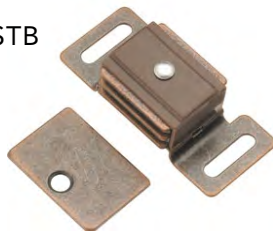

P651STB List \$ 7.09 ea.

### PRECISION PLS 24 PRO

Concealed Magnetic Catch

PLS Magnetic Pro is a Heavy  
Duty Concealed Magnetic  
Catch suitable for full size doors  
(e.g. wardrobe/cupboard,  
double internal doors).

Available in Black and Silver  
finishes.



Self Adhesive  
Cover Plate

Powerful Magnet

Adjustment  
Packers

Stainless Steel  
Housing Cup

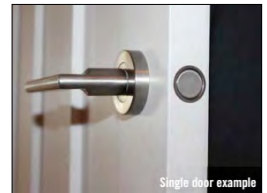

- Can be used anywhere a roller/ball catch, etc. would normally be fitted
- As magnets don't touch (after installation), the catch will never wear out, and can be painted over
- No latch noise when opening and shutting door
- Completely concealed when door closed, no unsightly protruding strike plate lip
- Can be used to keep problem doors shut (e.g. with weak door closers, electric strikes, weak roller mortise locks, double sliding doors)

Code	Description	List/ea
PLS24PRO	Heavy Duty Magnetic Catch, Silver finish	\$ 23.24
PLS24PRO-BLK	Heavy Duty Magnetic Catch, Black finish	27.74



## CATCHES

### AMEROCK CATCHES

Roller Catch.  
2" L x 1-3/4"W x 7/8" proj.  
25 each per box.

BP9745



<u>Code</u>	<u>Finish</u>	<u>List/ea</u>
BP9745-2G	Zinc	\$ 6.70

Double Roller Catch.  
1" L x .69" W.  
25 each per box.

BP3474



<u>Code</u>	<u>Finish</u>	<u>List/ea</u>
BP3474-14	Bright Nickel	\$ 1.63

Flexi-Grip Catch.  
1.25" L x .375" W.  
25 each per box.

BP3471



<u>Code</u>	<u>Finish</u>	<u>List/ea</u>
BP3471-2G	Zinc	\$ 1.82

Double Roller Catch.  
Chrome finish.  
25 each per box.

143-2G



1-5/16" L x 1-1/8" W x 1/2" proj.

<u>Code</u>	<u>List/ea</u>
143-2G	\$ 1.67

### AMEROCK CATCHES cont.

BP9823



Roller Catch. 1-3/4" L x 1-1/4" W x 3/8" H. Includes two strikes. 25 ea. per box.

<u>Code</u>	<u>Finish</u>	<u>List/ea</u>
BP9823-2G	Zinc	\$ 4.30

### BELWITH CATCHES

Double Roller Catch.  
1-3/8" H x 1". Cadmium.  
25 ea/box.



P107-2C List \$ 1.64 /ea.

P107-2C

Double Roller Catch.  
1-3/8" x 1". Stat. Bronze.  
25 ea/box.



P657STB List \$ 3.62 /ea.

P657STB

Double Roller Catch.  
1-5/8" H x 1-3/16". Cadmium.  
25 ea/box.



P108-2C List \$ 1.79 /ea.

P108-2C

## LATCHES



### DOUBLE DOOR LATCH

Eliminate the Elbow Catch



Eliminates the need for an elbow catch or other devices, and allows hardware to be installed out of the way at the top or bottom of door. Easy to install and use. Each Kit includes one each: Latch, Activator, Catch and Instructions.

- Doors can be closed in any order
- Low profile latch mechanism reduces product footprint inside cabinet
- Requires use of a single lock (sold separately)
- Allows two or three point locking for standard or wardrobe style double door cabinets when used with a lock
- Exceeds pull force above 150 lbs.
- Choose Black or White finish



6

300DL-BL



### How To Order

1. Determine location of the lock: Right or Left-Hand door
2. Decide where latch is needed: Top or Bottom-Mount
3. Choose your finish: Black or White

Lock Placement	Code	
	Top Mount	Bottom Mount
Right Door	200DL	300DL
Left Door	300DL	200DL

### Specifications

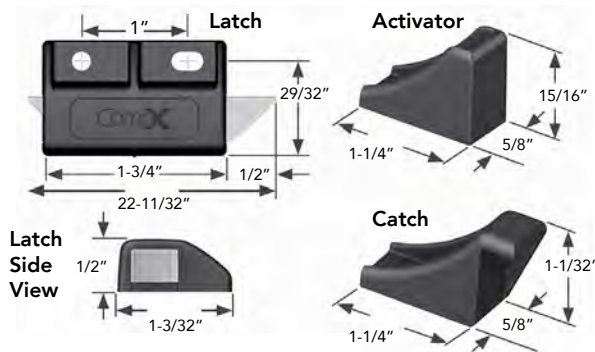

Note: For cabinets taller than 48" it is recommended to use both top and bottom mount latches

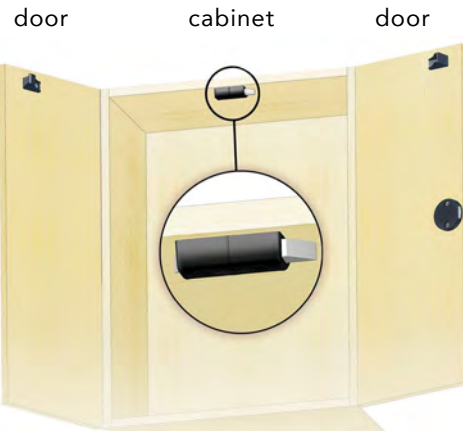

**Install Example:** DL200 with lock (sold separately) installed on right-hand door, top mount

The lock is mounted on the right hand door. Inside the right hand door, install the activator; on the non-locking door, install the catch.

Install latch inside the top of cabinet. The activator pushes the bolt on the latch to the other side to engage the catch. The bolt on the catch side is spring-loaded, allowing the doors to be closed in any order.

Turn the key to lock the other door; both doors are now secure. The locking door must be opened first to disengage the bolt in the latch – the bolt will slide back, allowing the non-locking door (with the catch) to open.

### Double Door Latch - 25 Kits/ Ctn.

Code	Finish	List/Kit
200DL-BL	Black	\$ 8.29
200DL-WH	White	8.29
300DL-BL	Black	6.86
300DL-WH	White	7.68



See Video at:  
[macpac1.com/videos.html#compX](http://macpac1.com/videos.html#compX)



## BULLET CATCHES

### KV BULLET CATCHES



Bullet catch. Varnish proof. Steel w/ brass barrel and spring. Barrel: 3/8" dia, 1/2" long. Strike: 5/8" dia. Dipped Brass. 100/box. 10 pcs. per bag.

Must order in increments of 10.

901 List \$ 2.23 /ea.



Bullet catch. Steel w/ brass barrel and spring. Barrel: 21/64" dia, 3/8" long. Strike: 5/8" dia. Dipped Brass. 100/box. 10 pcs. per bag.

Must order in increments of 10.

902 List \$ 2.31 /ea.



Adjustable bullet catch. Adjusts with any pointed object. Barrel: 3/8" dia, 5/8" long. Strike: 9/16" x 1-1/16". Dipped Brass. 100/box. 10 pcs. per bag.

Must order in increments of 10.

903 List \$ 7.00 /ea.



Adjustable barrel. Barrel: 1/2" dia, 1-1/32" long. Strike: 5/8" x 1-1/4". Dipped Brass. 50/box. 10 pcs. per bag.

Must order in increments of 10.

905 List \$ 8.19 /ea.

## ELBOW CATCHES

### EPCO HEAVY DUTY ELBOW CATCH

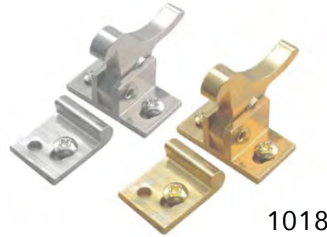

Solid brass, heavy-duty elbow catch is WIC listed. Catch has elongated holes providing for adjustment. Strike has one elongated hole and one round hole. The elongated hole provides adjustment on the strike and then a screw in the round hole anchors the strike so it will not spin. Can be mounted to a laminated surface. Polybagged with screws.

Overall Base Dimensions: 5/8" x 1-1/16"

Overall Catch Height: 1-1/16"

Strike Plate: 7/8" x 11/16" x 1/4"

Code	Finish	Ctn	List/ea
1018B	Bright Brass	10 ea.	\$ 6.53
1018N	Bright Nickel	10	6.52

### AMEROCK ELBOW CATCH

1-15/16" L x 1" W x 1/2" H. Steel. Bright Zinc Finish. 2 each per pack.



Code	Ctn	List/pk
BP3675-2G	25 pks.	\$ 6.65

### IVES ELBOW CATCH

Ideal for use on the inactive leaf of a pair of cabinet doors. Surface applied, making installation simple. Cast aluminum.

Plate: 1-3/8" high x 5/8" wide  
Strike: 13/16" high x 5/8" wide



Code	Finish	Ctn	List/ea
SP2A92	Aluminum	25 ea.	\$ 6.13

## CATCHES

### SELF-ALIGNING CABINET CATCH

"Bulldog"



Acts as a coupling between door and cabinet frame. Relieves strain on doors - door weight is no longer all on hinge screws. Smooth, quiet operation. Adjustable slotted steel bracket acts as a self-locating template. Pre-assembled screw-on strike is an automatic self-marker to the door. 5-1/2 lb. pull resistance.

Code	Finish	Ctn	List/ea
65S-BR	Brown	200 ea.	\$ 1.53

### KNUCKLE CATCH - Sugatsune

K-CATCH-WHT-T

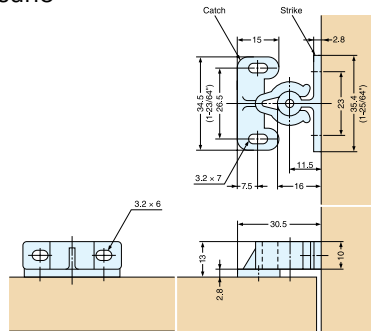

Grabs and holds doors tightly. White finish. Push/Pull force: 12.5 lbs/15.6 lbs.

Code	Description	Ctn	List/ea
K-CATCH-WH-T	White Knuckle Catch	100	\$ 1.21

## DOOR STOPS

### INSET DOOR STOP

Tenn-TEX

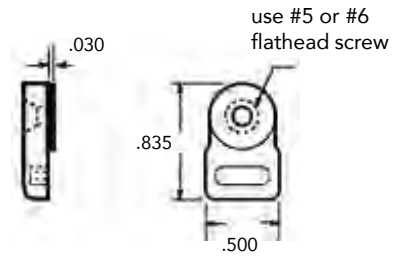

Door stop for cabinet inset doors. Clear in color. Uses #5 or #6 flathead screws (sold separately).

Code	Ctn	List/C
T230	1000 ea.	\$ 19.49

### INSET EURO DOOR STOP

Fastcap "Cam" adjustable inset stop

ED-BR



ED-CL



Easy to Adjust

Screw to desired depth

For use with inset cabinets. Simply screw inside cabinet and rotate to adjust where you want the cabinet door to shut.

Code	Color	Ctn	List/ea
ED-BR	Brown	100 ea.	\$ .27
ED-CL	Clear	100	.54

### DOOR STOP JIG

Fastcap

The Euro Door Jig is a compact tool used for accurate and repeatable placement of Euro Door Stops on cabinets.

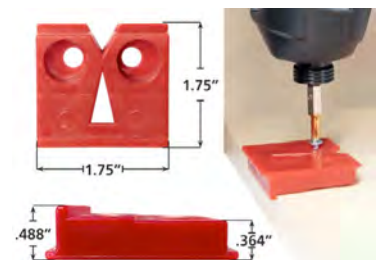

Door Stops sold separately (above).

Code	Description	List/ea
ED-JIG	Euro Door Stop Jig	\$ 7.84

## BALL CATCHES

### EPCO THREE WAY BALL CATCH

Solid extruded brass. Tension adjustable from both sides provided by set screws. Strike enters from front or either side. 10/box.



Length: 1-15/16". Width: 3/8"  
 Projection: 9/16" strike engaged.

Code	Finish	List/ea
1012DB	Dull Brass	\$ 8.82
1012DC	Dull Chrome	8.82

Length: 2-3/8", Width: 12/32"  
 Projection: 5/8" strike engaged.

1013DB	Dull Brass	\$ 14.03
1013DC	Dull Chrome	14.03

### TENSION CATCH - Sugatsune BCT/BCTS

Available in Polished Chrome on Zinc alloy and in Solid Polished Stainless Steel finish. Tension force is not adjustable.

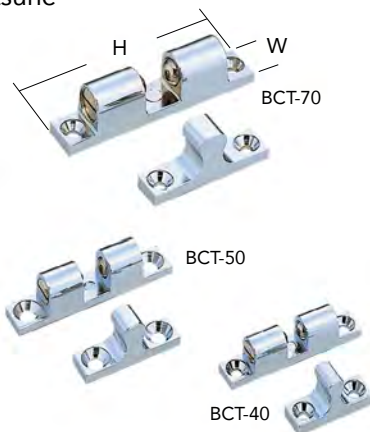

Code	Description	H	W	List/ea
BCT-40	Tension Catch, Lt	1-43/64"	.31"	\$ 6.47
BCT-50	Tension Catch, Md	1-31/32"	.39"	7.58
BCT-70	Tension Catch, Hvy	2-3/4"	.53"	12.13
BCTS-70	SS Ten Catch, Hvy	2-3/4"	.53"	71.78

### BALDWIN BALL CATCH - Solid Brass

Dual adjustment ball-bearing. Strike: 2.125" x 1.375". Lip to center: .875". Faceplate: 2.125" x 1". Bore: .875" dia. x 1.25" long. 10/box.



Code	Finish	List/ea
0426-003	Lifetime Polished Brass	\$ 28.02
0426-102	Oil Rubbed Bronze	28.02
0426-260	Polished Chrome	28.02
0426-264*	Dull Chrome	28.02
0426-150	Satin Nickel	28.02
0426-151	Antique Nickel	28.02
0426-112	Venetian Bronze	28.02

\*disc when out

### IDH BALL CATCH - Solid Brass

Dual adjustment. Lip strike is especially designed for use when catch is mounted in door.

Faceplate: 2-1/8" x 1"  
 Bore: 7/8" x 1-1/4"  
 Strike: 2-1/8" x 1-3/8"  
 Lip: 7/8" to center



Pack: 10 each.

Code	Finish	List/ea
12011-003	Polished Brass	\$ 11.64
12011-10B	Oil Rubbed Bronze	14.98
12011-026	Polished Chrome	14.98
12011-015	Satin Nickel	14.98
12011-26D	Dull Chrome	12.18
12011-005	Antique Brass	12.32

### IVES BALL CATCH - Solid Brass

Adjustable to clearance only. Faceplate: 1-1/2" x 3/4". Bore: 9/16" x 7/8". Strike: 1-1/2" x 25/32". Lip: 13/32" to center. 15/box.



Code	Finish	List/ea
SP345B3	Bright Brass	\$ 11.66



## ROLLER LATCHES

### **BALDWIN HEAVY DUTY ROLLER LATCH**

Solid Brass



0430

0432

0430 - Latch w/Full Lip Strike

0432 - Latch w/ T-Strike

For interior doors in hospitals or where quiet operation is required. Forged brass throughout. Adjustable roller projection. Screws included.

Faceplate: 3.38" L x 1" W. Mortise Depth: 1.69".

Code	Finish	List/ea
0430-003	Lifetime Pol. Brass	\$ 106.09
0430-056	Lifetime Sat. Nickel	106.09
0430-102	Oil R. Bronze	106.09
0430-264*	Dull Chrome	106.09
0430-150	Sat. Nickel	106.09
0430-260	Pol. Chrome	106.09
0432-102	Oil R. Bronze	106.09

\*disc when out

### **IVES ROLLER CATCH**

Solid Brass

With standard box type strike.



336

Adjustable spring tension roller catch. Solid brass.

Faceplate: 2-1/4" x 7/8". Bore: 3/4" x 1-3/4".

Lip: 1-1/8" to center. 10 each per box.

Code	Finish	List/ea
336B3	Polished Brass	\$ 16.79
336B10B	Oil R. Bronze	23.33
336B26	Polished Chrome	24.93
336B15	Satin Nickel	23.29
336B26D	Dull Chrome	18.12

### **BALDWIN ROLLER LATCH**

Solid Brass



0440

Adjustable tension heavy roller latch. Easily installed on thick doors. Fully adjustable from 3 lbs. to 18 lbs. Nylon rollers. Faceplate: 1.062" x 2-1/4", Bore: 1" dia. x 1.625" long, Strike: 2.75" x 1.125" Lip to center: 1.312"

Code	Finish	List/ea
0440-003	Lifetime Pol. Brass	\$ 33.03
0440-056	Lifetime Sat. Nickel	33.03
0440-030*	Pol. Brass	33.03
0440-050	Sat. Brass & Black	33.03
0440-102	Oil R. Bronze	33.03
0440-150	Satin Nickel	33.03
0440-260	Pol. Chrome	33.03
0440-264*	Dull Chrome	33.03
0440-112	Venetian Bronze	33.03

\*disc when out

### **IVES ROLLER CATCH**

Solid Brass

With strike for simplified mortising.



335

Adjustable spring tension roller catch. Solid brass.

Faceplate: 2-1/4" x 7/8". Bore: 3/4" x 1-3/4".

Lip: 1-3/16" to center. 10 each box.

Code	Finish	List/ea
335B3	Polished Brass	\$ 18.57
335B10B	Oil R. Bronze	20.73
335B15	Satin Nickel	19.11
335B26	Pol. Chrome	17.24
335B26D	Dull Chrome	20.00





## OLYMPUS LOCK

### OLYMPUS CABINET DOOR LOCK

For Commercial Doors

**Cabinet Door  
Rekeyable  
Deadbolt Lock**

100DR

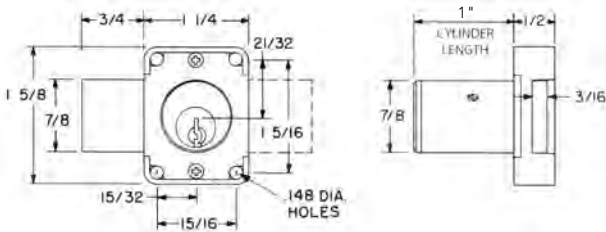

National D4292 5 pin keyway. Solid brass cylinder; pin tumbler. In stock keyed alike or different. Easily rekeyable. Includes bar strike (OL56-1).

Material Thickness: 7/8", Satin Chrome finish.

Code	Key #	Ctn	List/ea
100-26D78-	XXXXX	10 ea.	\$ 38.65

#### Available Key Numbers:

107, 915, G0001, G0002, G0003, G0004, G0005, G0006, G0007, KD (Keyed Different)

Material Thickness: 7/8",  
**Black** finish.



Code	Key #	Ctn	List/ea
100-1978-	G0001	20 ea.	\$ 53.53

### OLYMPUS CABINET DRAWER LOCK

For Commercial Drawers

**Cabinet Drawer  
Rekeyable  
Deadbolt Lock**

200DW

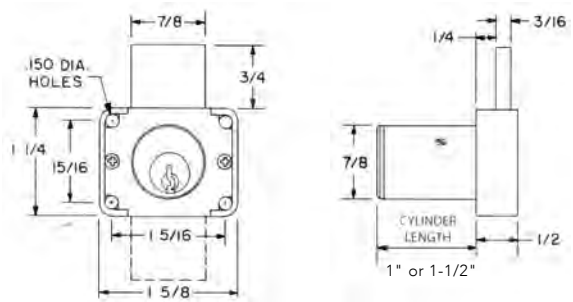

National D4292 5 pin keyway. Re-keyable pin tumbler lock. Pinned for 5, drilled for 6. Stocked keyed alike or different.

Material Thickness: 7/8", 1-3/8", or 1-5/8",  
Satin Chrome finish.

Code	Key #	Mat. Thkns	Ctn	List/ea
200-26D78-	XXXXX	7/8"	10 ea.	\$ 38.40
200-26D138-	XXXXX	1-3/8"	10	38.40
200-26D158-	XXXXX	1-5/8"	10	41.41

#### Black

200-1978-	G0001	7/8"	10	\$ 50.32
200-19138-	G0001	1-3/8"	10	50.32

#### Available Key Numbers for 26D finish:

7/8" = 107, 915, G0001 thru G0005, KD (Keyed Diff)

1-3/8" = 107, 915, G0001 thru G0009, KD

1-5/8" = G0001 thru G0007, KD

### OLYMPUS CABINET DRAWER LOCK

Commercial Cabinet Drawer Plunger Lock



**300SD  
Plunger Lock  
Rekeyable**

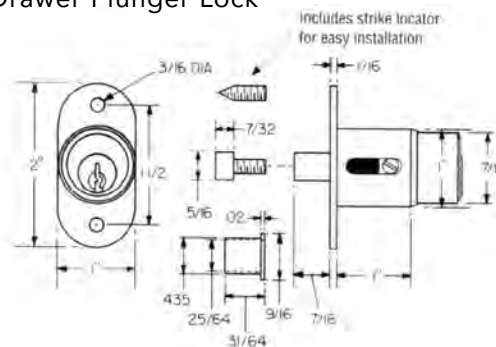

Speed release mechanism for easy rekeying. Pin tumbler cylinder drilled for 5-pin. Includes strike locator for accurate installation. Satin Chrome finish (26D). Keyed alike or different.

Material Thickness: 7/8"

Code	Key #	Ctn	List/ea
300SD-26D-	XXXXX	20 ea.	\$ 58.00

#### Available Key Numbers:

G0001 thru G0005, 915, KD (Keyed Different)



# OLYMPUS LOCK

## OLYMPUS PIN TUMBLER CAM LOCKS - Rekeyable

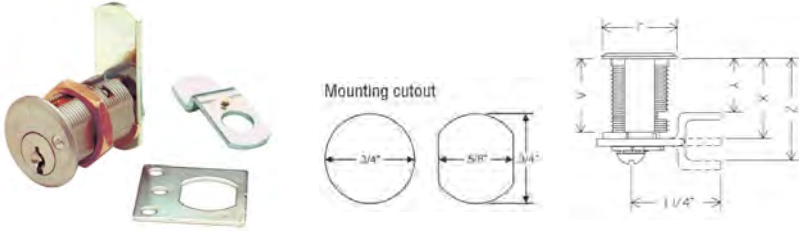

5-pin National D4292 keyway. Straight cam and offset cam included. Reversible cam, easy to install, higher security. Keyed alike or different.

Finish: 26D Satin Chrome.

Pack: 20 ea./box

	For Mat. Thickness	Straight Cam (X)	Inbent Cam (Y)	Outbent Cam (Z)	Cylinder Length (A)
DCN1	3/4"	1-1/16"	3/4"	1-3/8"	1"
DCN2	7/8"	1-3/16"	7/8"	1-1/2"	1-1/8"
DCN4	1-1/2"	1-13/16"	1-1/2"	2-1/8"	1-3/4"

Code	Mat. Thickness	List/ea
DCN1-26D-	3/4"	\$ 31.47
DCN2-26D-	7/8"	31.47
DCN4-26D-	1-1/2"	31.47

Available Key Numbers: G0001, G0002, G0003, G0004, G0005, 915, KD (Keyed Diff)

## PADLOCKABLE CAM LOCK

DCP



Cam Lock for use with padlock as locking device. Functions on doors and drawers. Ideal for locker applications. Max material thickness: 1-1/8". Barrel diameter: 3/4". US26 finish. Accepts most standard padlocks with a shackle diameter of 3/8" or less.

DCP-US26      15/bx      List: \$ 13.79 /ea.

## SPACER FOR 7/8" DIA LOCKS

WP21

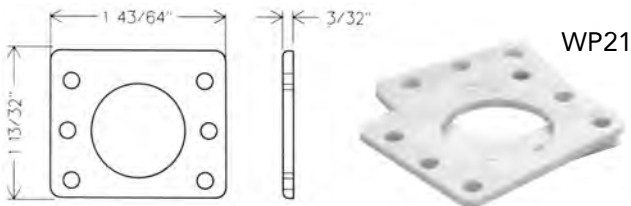

Thickness: 3/32" shim for flush mounting face of lock with face of cabinet. For 7/8" dia locks.

WP21      List: \$ 1.76 /ea.

## LARGE ANGLE STRIKE

Heavy duty angle strike.  
26D finish.



12-2      List \$ 3.58 /ea.

## PLASTIC BAR STRIKE

10-055

1/2" bar strike.  
White plastic finish.

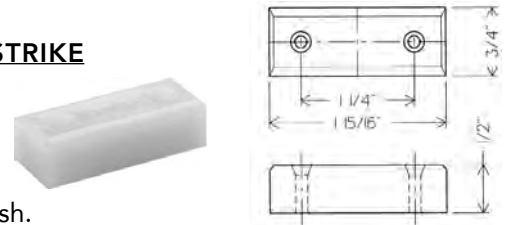

10-055      List \$ 3.02 /ea.

## NATIONAL KEYWAY CUT KEYS

KB-GM2MK-NP

Cut master key for National GM2 (5-pin) master key system.



KB-GM2MK-NP      List \$ 4.25 /ea.

## COMPX

### FLUSH DOOR INSTALLATION

CompX/National



For high security installations such as cash drawers. 90° bolt throw for left and right hand doors & drawers. Key removable in locked and unlocked positions. Bore: 3/4" dia. hole. Brass construction. Pin tumbler cylinder. Dull chrome finish. Pack: 10 each.

No.	Cyl. Length	Max. Material Thickness
C8102	1-1/16"	3/4"
C8106	1-7/16"	1-1/8"
C8108	1-3/4"	1-3/8"

Code	Keying	List/ea
C8102-26D-KA915	KA#915	\$ 34.52
C8106-26D-KA915	KA#915	34.52
C8108-26D-KA915	KA#915	34.53

### LIPPED DOOR INSTALLATION

CompX/National



C8103  
 C8109

Same specifications as the above locks. 26D finish. Brass construction. Pin tumbler cylinder. Dull chrome finish. Pack: 10 each.

Code	Keying	Max Mat. Thickness	Cyl. Length	List/ea
C8103-26D-KA915	KA#915	7/8"	1-3/16"	\$ 34.52

## CABINET LOCKS

### CHEST LID LOCK

CompX/National

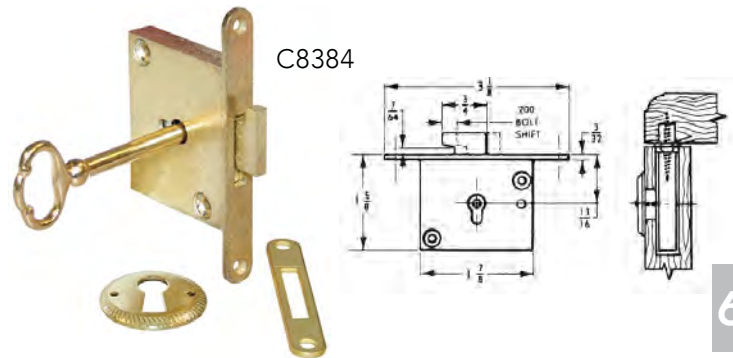

Requires full mortise and 1/2" dia. for keyhole. Hook-type bolt. Bolt travel: 5/16", .200 side shift. Key removable in locked and unlocked position. KA only. Packed with one key, screws, strikes, and keyhole escutcheons.

Code	Finish	Ctn	List/ea
C8384-3-KA	Pol. Brass	25	\$ 26.88

### EXTRA STRIKES FOR NATIONAL LOCKS



C2001  
 Formed Strike,  
 no bolt hole



C2002  
 Formed Strike,  
 no bolt hole,  
 countersunk holes  
 reversed

Pack: 25 each per bag. Sold in full bags only.  
 Overall Size: 1-3/4" x 1/2" with 3/16" form.

Code	Finish	Ctn	List/bag
C2001-14A	Nickel Plate	1 bag	\$ 45.41
C2002-14A	Nickel Plate	1 bag	45.25

**CABINET LOCKS**

**COMPX**

**CompX/National Surface Mounted Drawer Locks**



C8178

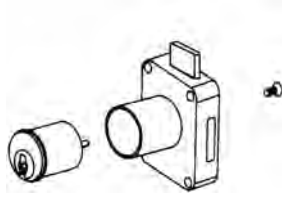

Removable Cylinder

Locks are reversible. Bore 7/8" dia. hole. Key removable in locked & unlocked positions. Brass construction. Pin tumbler. 3/4" bolt throw. Cylinder can be removed for rekeying while the lock stays in place.

No.	Cyl Length	Ctn
C8178	7/8"	10 ea
C8179	1-3/8"	10

Code	Finish	Keying	List/ea
C8178-26D-KA915	Dull Chrm	KA#915	\$ 45.02
C8178-4G-KA915	Ant. Brass	KA#915	45.02
C8179-26D-KA915	Dull Chrm	KA#915	45.02

**CompX/National Surface Mounted Door Locks**



C8173

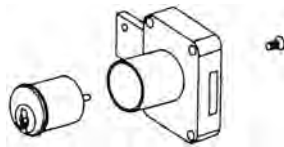

Removable Cylinder

Locks are reversible. Bore 7/8" dia. hole. Key removable in locked or unlocked positions. Brass construction. Pin tumbler. 3/4" bolt throw. Dull Chrome Finish. Cylinder Length: 7/8". Cylinder can be removed for rekeying while the lock stays in place.

Code	Ctn	Keying	List/ea
C8173-26D-KA915	10	KA#915	\$ 45.02

**CompX/National Door Lock: C8704**

Die-cast cylinder. Steel bolt. For wood up to 15/16" thick. 7/8" dia. hole required. Bolt Throw: 11/32".

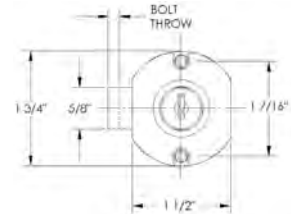

Pack: 25 each.

Code	Finish	Keying	List/ea
C8704-14A-KA415	Nickel Plate	KA#415	\$ 15.23

**CompX/National Drawer Locks: C8703**

Die-cast cylinder. Steel bolt. For wood up to 15/16" thick. 7/8" dia. hole required. Bolt Throw: 11/32".



**C8703** for wood up to 15/16" thick

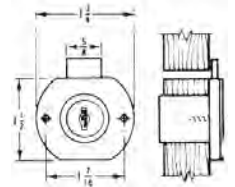

Pack: 25 each.

Code	Finish	Keying	List/ea
C8703-14A-KA346	Nickel Plate	KA#346	\$ 14.84
C8703-14A-KA413	" "	KA#413	14.84
C8703-14A-KA415	" "	KA#415	14.84

## COMPX

### DRAWER LOCK FOR FALSE FRONT DRAWERS

CompX/National

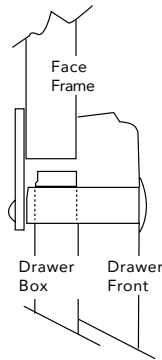

The C8060 has a cylinder length of 1-3/4" and a maximum material thickness of 1-7/16". The extra long cylinder makes this an ideal lock for false front drawers. It can also be used on cabinet doors in a lipped, overlay or flush mount. Choice of 90° or 180° cam turn. Key removable in locked and unlocked positions. Comes with two keys.

Code	Finish	Keying	List/ea
C8060-14A-KA346	Pol. Nickel	KA #346	\$ 15.18
C8060-14A-KA413	Pol. Nickel	KA #413	15.20
C8060-14A-KA415	Pol. Nickel	KA #415	15.19
C8060-14A-KD	Pol. Nickel	Keyed Diff.	15.20
C8060-3-KA413	Pol. Brass	KA #413	15.76
C8060-4G-KA415	Ant. Brass	KA #415	15.76
C8060-4G-KD	Ant. Brass	Keyed Diff.	15.76

### IMPROVED CAM LOCK STRIKE

Holes large enough for J085 (1/2 pan head) screws

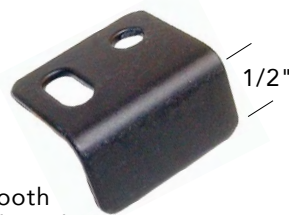

Smooth Radiused Corners

This adjustable strike has smooth radiused corners and holes large enough for J085 (1/2 x 8 Pan head) screws.

Code	Color	Ctn	List/ea
SP-101	Black	100 ea.	\$ 1.78

## CABINET LOCKS

### PADLOCKABLE CYLINDERS FOR LOCKERS

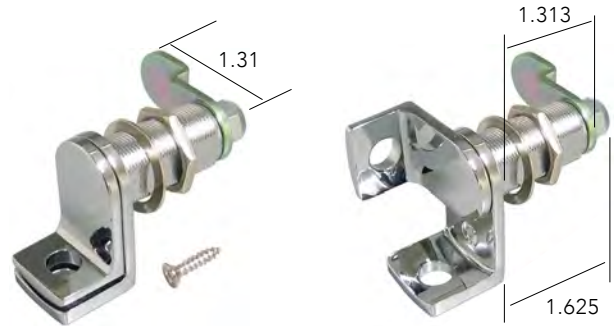

Closed position

Open position

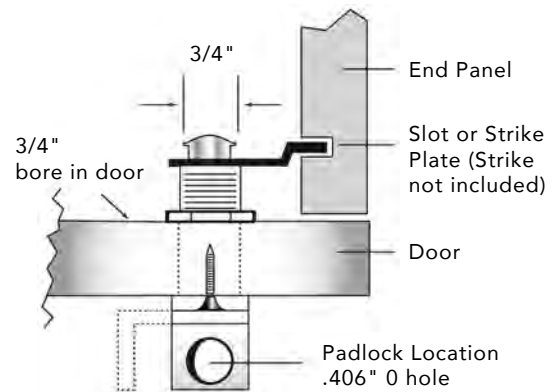

Padlockable lock cylinder can be used on sports lockers, country club lockers, band room lockers, employee lockers, etc. Each polybag includes cylinder, offset cam, nylon lock nut, body nut and body washer. Material is die-cast zinc, plated and polished. Padlock hole is .406" in diameter. Cylinder diameter is 3/4".

Code	Description	Finish	List/bg
5902	Locker latch	Pol. Chrome	\$ 19.19

## CABINET LOCKS

## COMPX

## TUMBLER CAMS

### CABINET CAM LOCKS FOR FLUSH OR LIPPED DOORS

CompX/National



C8051

C8052, C8053  
 C8054, C8055

6

Die cast cam locks. Supplied with two bolts: for 3/4" flush door or 3/4" door with 3/8" inset. Requires from 3/4" up to 13/16" dia. hole. Disc tumbler cylinder. 90° cam turn. Pack: 25 ea/box.

No.	Cyl. Length	Max. Material Thickness
C8051	7/16"	7/64"
C8052	5/8"	15/64"
C8053	1-3/16"	7/8"
C8054	15/16"	5/8"
C8055	1-7/16"	1-1/8"

Code	Finish	Keying	List/ea
C8051-14A-KA413	Nickel Plate	KA#413	\$ 10.83
C8051-14A-KD	" "	KD	10.83
C8052-14A-KA413	Nickel Plate	KA#413	10.83
C8052-14A-KA415	" "	KA#415	10.81
C8052-14A-KD	" "	KD	10.83
C8053-14A-KA413	Nickel Plate	KA#413	10.79
C8053-14A-KA415	" "	KA#415	10.79
C8053-14A-KA420	" "	KA#420	10.83
C8053-14A-KD	" "	KD	10.79
C8053-14A-KA346	" "	KA#346	10.79
C8053-14A-MKD	" "	KD-MKD	14.87
C8053-3-KA413	Pol. Brass	KA#413	11.45
C8053-3-KA415	" "	KA#415	11.45
C8053-3-KD	" "	KD	11.45
C8053-4G-KA413	Ant. Brass	KA#413	11.45
C8053-4G-KA415	" "	KA#415	11.44
C8053-4G-KD	" "	KD	11.45
C8054-14A-KA415	Nickel Plate	KA#415	10.83
C8054-14A-KD	" "	KD	10.83
C8055-14A-KA413	Nickel Plate	KA#413	10.83
C8055-14A-KA415	" "	KA#415	10.84
C8055-14A-KD	" "	KD	10.83
C8055-3-KD	Pol. Brass	KD	11.45
C8055-4G-KA415	Ant. Brass	KA#415	11.45

### DISC TUMBLER CAMS

CompX/National



C7014

Length: 1-5/8",  
 Offset: 5/16"

C7005

Length: 3"

The C8053 lock using the C7014 cam accommodates overlay construction using a 3/4" thick front and 3/4" thick frame.

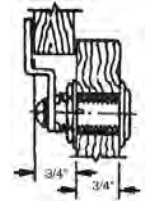

Code	Description	Ctn	List
C7005-2C	Straight Cam	25	\$ 2.04
C7014-2C	Double Formed Cam	25	2.68

### PIN TUMBLER CAMS

CompX/National

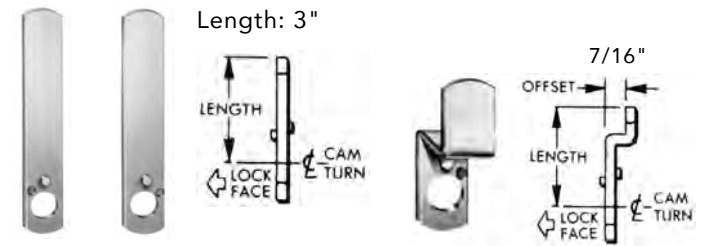

C7104

C7105

C7114

Applications - Solid lines show locked position of cam	Position of shifter on back of lock	Code	Description	List
		C7104-2C	Straight Cam	\$ 2.56
		C7105-2C	Straight Cam	\$ 2.56
		*C7114-2C	Double Formed Cam	\$ 3.11

\* For overlay construction using 3/4" thick front and 3/4" thick frame material. Use with C8102 pin tumbler locks.



## CABINET LOCKS

### StealthLock

#### Keyless Invisible Cabinet Locking System

Concealed locking for kitchen cabinets, liquor cabinets, entertainment units, healthcare cabinetry, lockers, office furniture, retail display cabinets, closet cabinets and storage.

Transmitter Pad may be stored anywhere, leaving no trace of visible hardware or signs of being secured. Allows multiple (individually accessible) wood cabinet doors or drawers to be locked from a single transmitter pad within a 15 foot range. Easy to install - takes fewer than 10 minutes. Replaces existing cabinet locks.



Residential/Closet



Lockers



Office

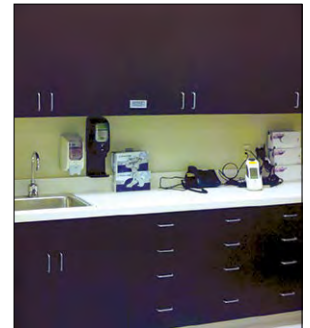

Commercial/Hospitals

### Features and Functions

- Transmitter pad operates within a 15 ft. range
- One transmitter pad can activate an unlimited number of receiver latches
- Separate user and supervisor codes (four to eight digits) to operate the lock(s)
- Receiver latch is easily programmed by user through the transmitter pad. Mounts within 1/2" drawer suspension clearance.
- Uses (4) AAA batteries (not included) for the receiver latch and a coin battery (included) for the transmitter pad. Low battery indicator on transmitter pad and receiver latch.
- Interior use only - recommended temp range of 50° to 120° F.

### Specs



### SL-100 StealthLock Kit

List \$ 236.28

#### Includes:

- 1 - Transmitter Pad
- 1 - Receiver Latch
- 1 - Cabinet Strike Plate (pre-installed into the receiver latch)
- 1 - Installation Tool (pre-installed into the receiver latch)
- 6 - #6 x 1/2" screws

### RL-110 Kit

List \$ 179.58

#### Includes:

- 1 - Receiver Latch
- 1 - Cabinet Strike Plate (pre-installed into the receiver latch)

**Example: To lock a two-door system using one transmitter pad, one SL-100 and one RL-110 are needed.**

### Components

Code	Description	List
RL-AP1	Power Supply 120V. Connects to Receiver Latch. Includes 5.5' cord	\$ 104.94
RL-APC-3	Link Cord, 3', for Receiver Latches	10.54
RL-APC-5	Link Cord, 5', " " " "	15.84



## CABINET LOCKS



### KIT-LOCKS: Keyless Locking Solutions for Cabinets and Lockers



#### **KL1000-G3**

5-3/8" Long  
1-5/16" Wide  
1-1/8" Deep

Silver Chrome  
and Black Chrome  
colors available.

KL1000-G3-SC - locked position

#### **Ideal applications:**

- Public lockers, hospitals, workstations.
- Wherever keyless entries are desired
- Easily retrofitted to settings with existing cam locks

#### **2 Modes:**

- Private: same code every time. Ideal for personal use
- Public: different code each time. Ideal for lockers with multiple users

#### **Includes:**

- Setup for 3/4" thick material
- Additional parts provided for material up to 1" thick and sheet metal up to 1/4"
- Drilling template and 2 AAA batteries included
- Default vertical orientation,
  - Horizontal Left and Right Hand orientations also available special order
- 2 year Guarantee by Manufacturer
- Key Override (Key purchased separately)
- Front battery change



Silver Chrome



Black Chrome

<u>Code</u>	<u>Description</u>	<u>List/ea</u>
KL1000-G3-SC	Kit Lock, Silver Chrome	\$ 148
KL1000-G3-BC	Kit Lock, Black Chrome	148
KL1000-G3-MK	Override Key for Kit Locks	70



**COMPX**

**CENTRAL LOCKING SYSTEM**

**DISC TUMBLER GANG LOCK**

CompX/National



D8090

**Application:** For locking drawers in desk pedestals and other multiple drawer applications. Requires 7/8" dia. hole for cylinder and dado for bar, measuring 7/8" x 1/8" deep on inside of panel.

**Operation:** Key removable in both locked and unlocked positions. Turning the key locks all drawers simultaneously (drawers must be in closed position). Bar moves studs into notch in drawer or slide, thus preventing drawer movement.

**Keying:** Will key together with all C8000 and C8700 series cabinet locks (except C8062). Available keyed alike (3 key codes), keyed differently (200 changes).

**Packaging:** Supplied with two keys, three each stud slides and locking studs, mounting hasp saddle and mounting screws.

**Bar Operation:** Deadlocking  
 Cylinder Length: 15/16"  
 Bar travel: 11/32"



Saddle reverses for mortise application



Releases plug from backside for rekeying

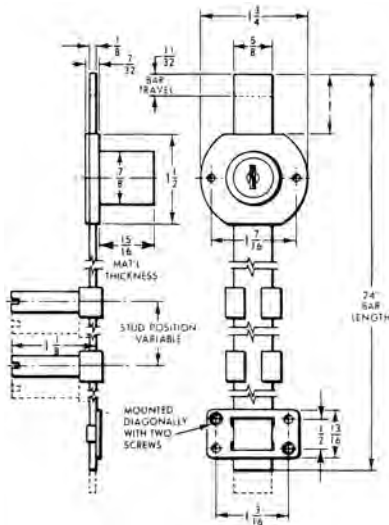

Mounting Hole:  
 Additional 7/8"x1/8" deep dado for bar required on inside of panel

<u>Code</u>	<u>Finish</u>	<u>Keying</u>	<u>List/ea</u>
D8090-14A-KA413	Nickel Plt.	KA#413	\$ 42.51



## SLIDING DOOR LOCKS

### KV SLIDING GLASS DOOR LOCKS

Glass sliding door lock, for up to 1/4" thick glass sliding doors. Adjustable for doors overlapping from 1" to 3-3/8".



Polished Nickel finish.  
12 ea/box.

<u>Code</u>	<u>Keying</u>	<u>List/ea</u>
965KA	Alike	\$ 53.40



Heavy duty sliding glass door lock, for doors 1/4" thick overlapping 3/4" to 3-3/8". Polished Chrome Finish.  
12 ea/box.

<u>Code</u>	<u>Keying</u>	<u>List/ea</u>
963KA	Alike	\$ 60.48

### WOOD SLIDING DOOR LOCKS

Parker

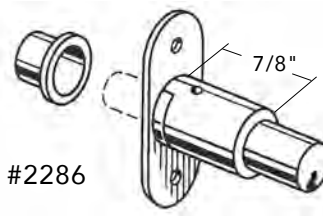

Lock Bore: 5/8"  
Bolt Dia: 9/32"  
Plate: 1-7/8" x 3/4"  
Strike Bore: 5/8"  
For 7/8" material

Elongated mounting plate, 1-7/8" x 3/4". Solid brass bolt 9/32" dia. for 7/8" material. KA only, w/screws and strike.

<u>Code</u>	<u>Finish</u>	<u>Ctn</u>	<u>List/ea</u>
2286PB	Polished Brass	10 ea.	\$ 20.99
2286PC	Polished Chrome	10 ea.	23.61

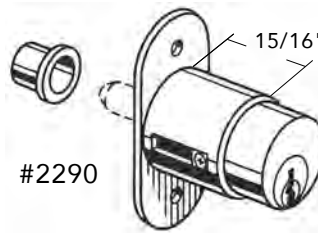

Lock Bore: 7/8"  
Bolt Dia: 5/16"  
Plate: 2" x 7/8"  
Strike Bore: 3/8"  
For 7/8" material

Pin tumbler lock mounts same as 2286.  
For 7/8" material. Keyed alike.

<u>Code</u>	<u>Finish</u>	<u>Ctn</u>	<u>List/ea</u>
2290PB	Polished Brass	10 ea.	\$ 28.30
2290PC	Polished Chrome	10 ea.	33.87

**National / Olympus Conversion Chart**

<b>National</b>		<b>Olympus</b>	
C8102	Cam Lock, 1-1/16"	DCN1	Cam Lock, 1-1/16"
C8111	Cam Lock, 15/16"	DCN1	Cam Lock, 1-1/16"
C8112	Cam Lock, 1-1/16"	DCN1	Cam Lock, 1-1/16"
C8103	Cam Lock, 1-3/16"	DCN2	Cam Lock, 1-3/16"
C8113	Cam Lock, 1-3/16"	DCN2	Cam Lock, 1-3/16"
C8106	Cam Lock, 1-7/16"	DCN3	Cam Lock, 1-7/16"
C8108	Cam Lock, 1-3/4"	DCN4	Cam Lock, 1-3/4"
C8109	Cam Lock, 1-3/4"	DCN4	Cam Lock, 1-3/4"
N/A		FC10	File Cabinet Lock F24/F28/F26
C8123	Door Lock 7/8"	100DR	Door Lock 7/8"
C8173	Door Lock 7/8"	100DR	Door Lock 7/8"
C8124	Door Lock 1-1/8"	100DR	Door Lock 1-3/8"
C8174	Door Lock 1-1/8"	100DR	Door Lock 1-3/8"
C8125	Door Lock 1-3/8"	100DR	Door Lock 1-3/8"
C8175	Door Lock 1-3/8"	100DR	Door Lock 1-3/8"
C8138	Drawer Lock 7/8"	200DW	Drawer Lock 7/8"
C8178	Drawer Lock 7/8"	200DW	Drawer Lock 7/8"
C8148	Drawer Lock 1-1/8"	200DW	Drawer Lock 1-3/8"
C8177	Drawer Lock 1-1/8"	200DW	Drawer Lock 1-3/8"
C8149	Drawer Lock 1-3/8"	200DW	Drawer Lock 1-3/8"
C8179	Drawer Lock 1-3/8"	200DW	Drawer Lock 1-3/8"
C8180	Drawer Lock 1-5/8"	200DW	Drawer Lock 1-5/8"
C8142	Sliding Door Lock 1-1/8"	300SD	Sliding Door Lock 1"
C8140	Showcase/Ratchet Lock	329R	Showcase/Ratchet Lock
C8163	Drawer Lock 7/8"	N078	Drawer Lock 1-1/8"
N/A		N078	Drawer Lock 1-3/8"
N/A		N078	Door Lock 1-1/8"
N/A		N078	Door Lock 1-3/8"
C8131	Drawer Latch 7/8"	998	Drawer Latch 7/8"
N/A		998	Drawer Latch 1-3/8"
C8139	Drawer Latch 3/4"	999	Door Latch 7/8"
N/A		999	Door Latch 1-3/8"
C8137	T-Bolt Drawer Lock	T37	T-Bolt Drawer Lock

**Schlage / Olympus Conversion Chart**

Schlage		Olympus	
CL100PB	Door Lock 1-1/8"	700S	Door Lock 1-1/8"
CL100PB	Door Lock 1-3/8"	700S	Door Lock 1-3/8"
CL200PB	Drawer Lock 1-1/8"	800S	Drawer Lock 1-1/8"
CL200PB	Drawer Lock 1-3/8"	800S	Drawer Lock 1-3/8"
CL777R	Door Lock 1-7/16"	777ICP	Door Lock 1-7/16" for Schlage full-size interchangeable core
CL888R	Drawer Lock 1-7/16"	888ICP	Drawer Lock 1-7/16" for Schlage full-size interchangeable core
CL920R	Cam Lock	920	Cam Lock for Schlage full-size interchangeable core
CL929R	Showcase/Ratchet Lock	929R	Showcase/Ratchet Lock for Schlage full-size interchangeable core
N/A		L78	Latch Lock (Field Reversible)
N/A		820S	Cam Lock
N/A		829R	Showcase/Ratchet Lock
N/A		850S	Deadlatching Lock
N/A		L78LC	Latch Lock (Field Reversible)

**Best / Olympus Conversion Chart**

Best		Olympus		Best		Olympus	
N/A		721DR	Door Lock 1-1/4"	N/A		725ML	Mortise Latch Door Lock - Right Hand
3L7RD2	Rim Deadbolt Drawer Lock	721DW	Drawer Lock 1-1/4"	N/A		725ML	Mortise Latch Door Lock - Left Hand
5L7RD2	Rim Deadbolt Drawer Lock - Vert	725RD	Rim Deadbolt Drawer Lock - Vert	5L7ML5	Mortise Latch Drawer Lock - Inverted	725ML	Mortise Latch Drawer Lock - Inverted
N/A		725RD	Rim Deadbolt Door Lock - Right Hand	5L7RL2-SL	Rim Square Latch Enclosure Lock	725RSL	Rim Square Latch Enclosure Lock
N/A		725RD	Rim Deadbolt Door Lock - Left Hand	8L7SPR	Mail Box Lock	728MBL	Mail Box Lock
5L7RD5	Rim Deadbolt Drawer Lock - Inverted	725RD	Rim Deadbolt Drawer Lock - Inverted	1E7E4	Cam Lock 1-1/8" diameter	720	Cam Lock 1-1/8" diameter
5L7RL2	Rim Latch Drawer Lock - Vert	725RL	Rim Latch Drawer Lock - Vertical	1E7D4	Cam Lock 1-1/8" diameter	720B-DM	Cam Lock 1-1/8" diameter Dir Drive
N/A		725RL	Rim Latch Door Lock - Right hand	5E Series	Cam Lock 3/4" diameter	B7	Cam Lock 3/4" diameter
N/A		725RL	Rim Latch Door Lock - Left hand	2P73	File Cabinet Lock	724VR	File Cabinet Lock
5L7RL5	Rim Latch Drawer Lock - Inverted	725RL	Rim Latch Drawer Lock - Inverted	2S	Sliding Door Plunger Lock	722S	Sliding Door Plunger Lock
5L7MD2	Mortise Deadbolt Drawer Lock - Vert	725MD	Mortise Deadbolt Drawer Lock - Vert	2S-TBM	Sliding Door Plunger Lock (thru-bolt)	722S	Sliding Door Plunger Lock (thru-bolt)
N/A		725MD	Mortise Deadbolt Door Lock - Right hand	3S	Showcase/Ratchet Lock	729R	Showcase/Ratchet Lock
N/A		725MD	Mortise Deadbolt Door Lock - Left hand	4S	Sliding Door Cylinder Housing	723S	Sliding Door Cylinder Housing
5L7MD5	Mortise Deadbolt Drawer Lock - Inverted	725ML	Mortise Deadbolt Drawer Lock - Inverted	N/A		950IC	Deadlatching Drawer Lock
5L7ML2	Mortise Latch Drawer Lock - Vert	725ML	Mortise Latch Drawer Lock - Vert				



## **SALICE HINGES**

### **Table of Contents**

Accessories.....753	Face Frame (One Piece Hinges)..... 779-80
Air Hinge..... 747-48	Glass Door.....749
Angled Assembly..... 739-41	Institutional..... 782
Baseplates	Large Overlays (see Thick Door)
Frameless.....709-10	Logica, Tool-Free.....729
Faceframe..... 711-12	Machines, Insertion.....750-52
Blind Corner.....742-43	Mini Hinge.....746
Common Application Hinges	Negative Angle.....740-41
94° Opening	Pie-Cut..... 737-38
Soft Close.....715	Positive Angle.....739, 741
Self Close.....713-14	Push System..... 745
105° Opening	Rapido, Rapid Mount.....730
Soft Close.....717-18	Short Arm.....715
Self Close..... 716	Smove..... 754-56
110° Opening	Super Hinge.....722
Soft Close.....721	Thick Door
Self Close.....719-20	94° Opening..... 713-15, 731-32
120° Opening.....723-24	155° Opening.....725
155° Opening	Thin Door.....716
Soft Close.....726	Titanium Finish..... 744
Self Close..... 725	Zero Protrusion.....725-26
165° Opening.....727-28	
Compact Hinges..... 779-80	



# SALICE

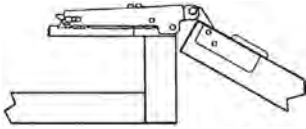

# SALICE

## FOR FACE FRAME CABINETS



### Popular Hinges/Baseplates for Face Frame Cabinets

Hinges for 3/4" Overlay (5mm Tab)

Soft Close	Self Close
C1R6AE9 (105°)	C2R6A99 (110°)
C7R6AE9 (110°)	C2R9A99 (120°)
	C2RFA99 (165°)

<b>Baseplate: 1mm</b>
BAU3L19
BAU3R19

7 Hinges for 5/8" Overlay (5mm Tab)

Soft Close	Self Close
C1R6AE9 (105°)	C2R6A99 (110°)
C7R6AE9 (110°)	

<b>Baseplate: 4mm</b>
BAU3L49
BAU3R49

Hinges for 1/2" Overlay

Soft Close	Self Close
C1R6DE9 (105°)	C2R6D99 (110°)
C7R6DE9 (110°)	C2R9D99 (120°)
	C2RFD99 (165°)

<b>Baseplate: 1mm</b>
BAU3L19 on 1mm plates tab is 4-6mm
BAU3R19

Soft Close	Self Close
C1R6AE9 (105°)	C2R6A99 (110°)
C7R6AE9 (110°)	C2R9A99 (120°)
	C2RFA99 (165°)

<b>Baseplate: 6mm</b>
BAU3R69 on 6mm plates tab is 3.5-4.5mm

Hinges for 3/8" Overlay

Soft Close	Self Close
C1R6GE9 (105°)	C2R6G99 (110°)
C7R6GE9 (110°)	C2R9G99 (120°)
	C2RFG99 (165°)

<b>Baseplate: 1mm</b>
BAU3L19
BAU3R19

Hinges for Inset

Soft Close	Self Close
C2RBGE9 (94°)	C2RBG99 or C2RBD99 (94°)
C7R6GE9 (110°)	C2R6G99 or C2R6D99 (110°)

<b>Baseplate: Inset</b>
BAL3R59

### SALICE - TECHNICAL EXCELLENCE



All Salice Hinges have received the most important international quality certificates (ANSI/BMHA, FIRA, CTBA, LGA). The 200 Hinge Series has also received the FIRA Gold Award for technical excellence. They are WI Approved and are certified ISO 9001.



**SALICE**



**SALICE**

**FOR FRAMELESS CABINETS**

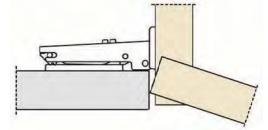

**Popular Hinges/Baseplates for Frameless Cabinets**

**Hinges for Full Overlay**

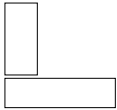

Soft Close	Self Close
C1R6AE9 (105°)	C2R6A99 (110°)
C7R6AE9 (110°)	C2R9A99 (120°)
	C2RFA99 (165°)

Plate: 3/4" Overlay
Any 0mm plate (e.g. BAR3R09)

Plate: 11/16" Overlay
Any 2mm plate (e.g. BAR2R09)

**Hinges for Half Overlay**

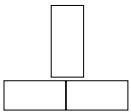

Soft Close	Self Close
C1R6GE9 (105°)	C2R6G99 (110°)
C7R6GE9 (110°)	C2R9G99 (120°)
	C2RFG99 (165°)

Plate: 3/4" Panel
Any 0mm plate (e.g. BAR3R09)
Alternate solution obtained with a Full Overlay hinge + a 9mm plate

**Hinges for Inset**

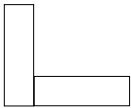

Soft Close	Self Close
C2RBPE9 (94°)	C2RBP99 (94°)
C7R6PE9 (110°)	C2R6P99 (110°)
	C2RFP99 (165°)

Plate
3mm plate (e.g. BAR3R39)

Soft Close	Self Close
C1R6GE9 (105°)	C2R6G99 (110°)
C7R6GE9 (110°)	C2R9G99 (120°)
	C2RFG99 (165°)

Plate
9mm plate (e.g. BAR3R99)

Soft Close	Self Close
C1R6AE9 (105°)	C2R6A99 (94°)
C7R6AE9 (110°)	C2R9A99 (110°)
	C2RFA99 (165°)

Plate
18mm plate (e.g. BAR3RV9)

**Recommended Number of Hinges Per Door**

The number of hinges required depends on the size, weight and quality of the door. The distance between the hinges should be spaced as wide as possible. See below to determine number of hinges needed. For doors to 24" wide, weighing:

- Up to 20 lbs. 2 hinges
- 20 to 40 lbs. 3 hinges
- 40 to 60 lbs. 4 hinges

**Boring Distance From the Edge of the Door (K)**

- 94° 3 to 8mm
- 110° 3 to 6mm
- 120° 3 to 6mm
- 165° 3 to 8mm

(Matches Blum Drilling Pattern)

**SALICE**

**QUICK REFERENCE GUIDE - Soft Closing Hinges**

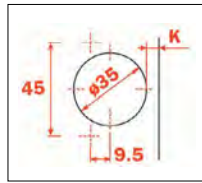

Screw-In

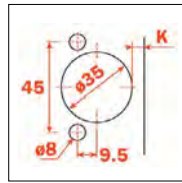

Knock-In Dowel,  
 Rapido, Logica

**Salice Soft Closing (Pistons)  
 Cabinet Hinges**

Soft Close Action is  
 Concealed within the  
 Hinge Cup



Knock-In  
 Dowel



Screw-On  
 Cup



Rapido



Logica



7

**94° Soft Close, for Doors 3/4" to 1-1/4" Thick**

	<u>Dowel</u>	<u>Wood Screw</u>	<u>Rapido</u>	<u>Logica</u>
94° Full Overlay	C2RBAE9	-	C27BAE9	C2JBAE9
94° 1/2" Overlay	-	-	-	-
94° Half Overlay	C2RBGE9	-	-	-
94° Inset	C2RBPE9	-	-	-

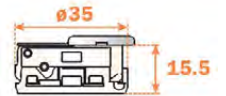

**105° Soft Close, for Doors 15 - 20mm Thick**

	<u>Dowel</u>	<u>Dowel (Titanium*)</u>	<u>Wood Screw</u>	<u>Rapido</u>	<u>Logica</u>
105° Full Overlay	C1R6AE9	C1R6AE6	C1P6AE9	C176AE9	C1J6AE9
105° 1/2" Overlay	C1R6DE9	C1R6DE6	C1P6DE9	C176DE9	C1J6DE9
105° Half Overlay	C1R6GE9	C1R6GE6	C1P6GE9	C176GE9	C1J6GE9
105° Inset	C1R6PE9	C1R6PE6	C1P6PE9	C176PE9	C1J6PE9

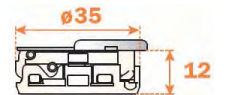

**110° Soft Close, for Doors 16 - 26mm Thick**

	<u>Dowel</u>	<u>Dowel (Titanium*)</u>	<u>Wood Screw</u>	<u>Rapido</u>	<u>Logica</u>
110° Full Overlay	C7R6AE9	C7R6AE6	C7P6AE9	C776AE9	C7J6AE9
110° 1/2" Overlay	C7R6DE9	-	C7P6DE9	C776DE9	C7J6DE9
110° Half Overlay	C7R6GE9	-	C7P6GE9	C776GE9	C7J6GE9
110° Inset	C7R6PE9	-	C7P6PE9	C776PE9	C7J6PE9

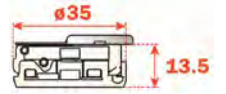

**155° Soft Close, for Doors up to 15mm Thick**

	<u>Dowel</u>	<u>Wood Screw</u>	<u>Rapido</u>	<u>Logica</u>
155° Full Overlay	C2RKA9	-	C27KA9	C2JKA9
155° 1/2" Overlay	C2RKDE9	-	-	-
155° Half Overlay	C2RKGE9	-	-	-
155° Inset	C2RKPE9	-	-	C2JKPE9







**QUICK REFERENCE GUIDE - Self Closing Hinges**

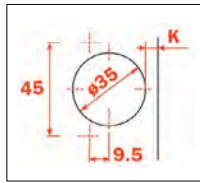

Screw-In

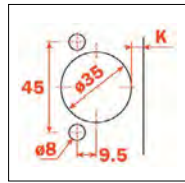

Knock-In Dowel,  
 Rapido, Logica

**Salice Self Closing (Spring Loaded)  
 Standard Hinges**

Spring Loaded Action  
 Quickly Closes Cabinet Door



Knock-In  
 Dowel

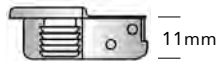

Screw-On  
 Cup



Rapido



Logica



**94° Self Close, for Thick Doors up to 32mm thick (1-1/4")**

	<u>Dowel</u>	<u>Wood Screw</u>	<u>Rapido</u>	<u>Logica</u>
94° Full Overlay	C2RBA99	C2PBA99	C27BA99	C2JBA99
94° 1/2" Overlay	C2RBD99	-	-	-
94° Half Overlay	C2RBG99	C2PBG99	-	-
94° Inset	C2RBP99	C2PBP99	C27BP99	C2JBP99

**105° Self Close, for Thin Doors down to 10mm. Cup Depth 8mm.**

	<u>Dowel</u>	<u>Wood Screw</u>	<u>Rapido</u>	<u>Logica</u>
105° Full Overlay	C1P6A99	-	-	-
105° Half Overlay	C1P6G99	-	-	-

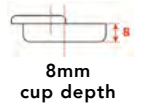

**110° Self Close, for Doors up to 13/16" thick**

	<u>Dowel</u>	<u>Dowel (Titanium*)</u>	<u>Wood Screw</u>	<u>Rapido</u>	<u>Logica</u>
110° Full Overlay	C2R6A99	C2R6A66	C2P6A99	C276A99	C2J6A99
110° 1/2" Overlay	C2R6D99	C2R6D66	C2P6D99	C276D99	C2J6D99
110° Half Overlay	C2R6G99	C2R6G66	C2P6G99	C276G99	C2J6G99
110° Inset	C2R6P99	C2R6P66	C2P6P99	C276P99	C2J6P99

**120° Self Close, for Doors 16 - 26mm thick**

	<u>Dowel</u>	<u>Wood Screw</u>	<u>Rapido</u>	<u>Logica</u>
120° Full Overlay	C2R9A99	C2P9A99	C279A99	C2J9A99
120° 1/2" Overlay	C2R9D99	C2P9D99	C279D99	C2J9D99
120° Half Overlay	C2R9G99	C2P9G99	C279G99	-

**165° Self Close, for Doors up to 28mm thick**

	<u>Dowel</u>	<u>Dowel (Titanium*)</u>	<u>Wood Screw</u>	<u>Rapido</u>	<u>Logica</u>
165° Full Overlay	C2RFA99	C2RFA66	C2PFA99	C27FA99	C2JFA99
165° 1/2" Overlay	C2RFD99	C2RFD66	-	C27FD99	C2JFD99
165° Half Overlay	C2RFG99	C2RFG66	C2PFG99	C27FG99	C2JFG99
165° Inset	C2RFP99	C2RFP66	C2PFP99	C27FP99	C2JFP99

\*Titanium is a dark finish. See page 744 for details



## SALICE

### SPECIALTY SALICE HINGES - Quick View

#### Salice Hinges for Positive and Negative Angles

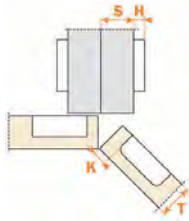

+45°

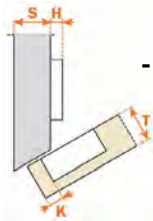

-30°

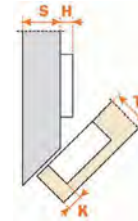

-45°

#### Hinges for +45° Kitchen Corners:

- C7R6ME9AC Soft Close
- C2RBM99AC Self Close
- BAR3R39 Baseplate

#### Hinges for -30° Angle:

- C7R6WE9 Soft Close
- C2RBW99 Self Close
- BARGR39/16 Baseplate

#### Hinges for -45° Angle:

- C2RBH99 Self Close
- BARGR39/16 Baseplate

To achieve the correct corner design with any specialty corner hinge you ALWAYS need to use a 3mm plate, for example: BAR3R39 or BARGR39/16 (has pre-attached Euro screws). The tab (boring) distance is ALWAYS 3 to 4mm (1/8") from edge of door.

For a complete selection of Positive and Negative Hinges, see pgs. 739-741

For a variety of Special Angled Assembly Hinges with Specialty Plates, see pgs.737-743

#### Salice Hinges for Blind Corners

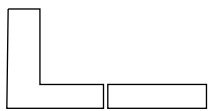

#### **Example:**

- C2RBN99AC Hinge (94° opening)
- BAR3R39 Baseplate (3mm)



Always use a 3mm Euro Baseplate with a Blind Corner Hinge. The tab (boring) distance is ALWAYS 3 to 4mm (1/8") from edge of door.

For a complete selection of Blind Corner Hinges, see pgs. 742-743

#### Salice Hinges for Pie Cut Corners

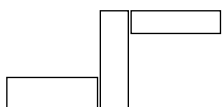

#### **Example:**

- C2RYA99 Hinge (94° opening)
- BAR3R39 Baseplate (3mm)



Always use a 3mm Euro Baseplate with a Pie Cut Corner Hinge. The tab (boring) distance is ALWAYS 3 to 4mm (1/8") from edge of door.

For a complete selection of Pie Cut Corner Hinges, see pgs. 737-738



## SPECIALTY SALICE HINGES - Quick View

**SALICE**

### "Super Hinge" 110° x 35mm Cup x 9mm Deep (B Series)



CBP2AC9	Self-Close
CBP2AE9	Soft-Close
CBPQAC9	Push Series

- Drill Tab 3mm - 18mm
- Overlays up to 3/4" (19mm)
- 3/8" Lip doors
- Thick doors: Up to 7/8" thick
- Can obtain zero gap between adjacent doors or panels
- Doors as thin as 3/8"
- Swings out from case like 165° hinge
- Furniture applications

Pg # 722

### "Shallow Cup Hinge" 105° x 35mm Cup x 8mm Deep (100 Series)



C1P6A99	Self-Close	Full Overlay
C1P4A99*	Free Swing	Full Overlay
C1P6D99*	Self-Close	D Crank
C1P4D99*	Free Swing	D Crank
C1P6G99	Self-Close	Half Overlay
C1P4G99*	Free Swing	Half Overlay

- For Unusually Thin Doors (10mm)
- Tab possibilites 3mm - 6mm (1/8" - 1/4")
- Non Dowelled
- Gap between Doors:  
.2mm on 10mm Door  
2.3mm on 19mm Door

Pg # 716

### "Thick Door Hinge" 94° x 35mm Cup x 11mm Deep (200 Series)



	Self Close
C2RBA99	Full Overlay
C2RBD99	D Crank
C2RBG99	Half Overlay
C2RBP99	Inset

- For Doors up to 1-1/4" Thick
- Less concern of Drilling through coping detail
- No need to take out 8mm dowel bits on Thick Doors
- Possible Tab Distance 3mm - 9mm on Square Edge Doors (1/8" - 11/32"). Larger Tabs on Front Detailed Doors
- Overlays up to 24mm (15/16")
- All Hinges are dowelled

Pg # 713

### "Zero Protrusion Hinge" 155° x 35mm Cup x 8mm Deep (200 Series)



	Self Close
C2PKA99	Full Overlay, Screw-On
C2RKA99	Full Overlay, Dowel

- Use Full Overlay so door profile clears opening for pull-out shelves
- -2mm clearance on 0mm plates
- -1mm clearance on 1mm Face Frame plates
- Possible Tab Distance 3mm - 8mm
- Thin Doors 10mm (3/8")
- Thick Doors up to 22mm (7/8")
- Door clears opening @ 90° opening angle

Pg # 725



## SALICE

### SPECIALTY SALICE HINGES - Quick View

#### "Mini Hinge" (400 Series)

94° x 26mm Cup x 11.5mm Deep

Pg # 746



Self Close Only

C4A7A99	Full Overlay
C4A7P99	Inset Hinge

- Great for Narrow Stile Doors
- Tab Distances 3mm - 8mm (1/8" - 5/16")
- Doors as thin as 12.7mm (1/2")
- Overlays up to 20.5mm (13/16")
- Wood Doors with Narrow Stiles & Glass Center Panels
- Gaps between adjacent doors "tight"
  - 1mm on 3/4" Thick Doors with 8mm Tab
  - 1.3mm on 3/4" Thick Doors with 3mm Tab
- Also available in 30° & 45° Corner Hinges
- Works on all Standard Base Plates
- 26mm Bit in Stock
- Non-Dowelled

7

#### "Push Series Hinge"

35mm Cup x 11mm Deep

"Doors Are Self-Opening"



C2PPA99	110° Full Overlay	Screw On
C2PPP99	110° Inset	Screw On
C2RPA99	110° Full Overlay	Dowelled
C2RPD99	110° 1/2" Overlay	Dowelled
C2RPG99	110° Half Overlay	Dowelled
C2RPP99	110° Inset	Dowelled
C2RSA99	165° Full Overlay	Dowelled
C2RSP99	165° Inset	Dowelled
CBQAC9	110° Super Hinge w/9mm Cup Depth	
C2RVA99	94° for Thick Doors	Dowelled

- Your "No Knob" Solution
- Mirrored Doors
- Concealed Panels
- Displays
- Use with a specialty catch: 26mm bore, surface mounted or 10mm concealed magnetic.
- Replaces touch latches
- Operate with 1.5mm push release
- Works on all standard base plates

Pg # 745

#### "Thick Door / Large Overlay Hinge" (F Series)

94° x 40mm Cup x 13mm Deep

Pg # 731



CFA7A99	Full Overlay, Self-Close
CFA5A99	Full Overlay, Free Swing
CFA7G99	Half Overlay, Self-Close
CFA5G99	Half Overlay, Free Swing
CFA7P99	Inset, Self-Close
CFA5P99	Inset, Free-Swing

- Doors up to 40mm Thick (1-1/2")
- Tab Drilling from 3mm - 15mm
- Overlays up to 34mm (1-3/8")
- Gaps between adjacent doors as little as 1.3mm on 1" Thick Square Edge Doors, 5.4mm Gap on Doors 1-1/2" Thick
- Very low "L" values as small as 0mm (behind door)
- Works on all standard base plates
- Overlay Pocket Doors
- Thick Pocket Doors
- Self Close and Free Swing

## SPECIALTY SALICE HINGES - Quick View

**SALICE**

### Salice Rapido - Rapid Mount & Removal

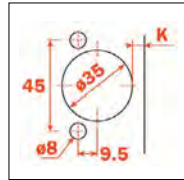

Standard Door Drilling  
 Salice/Blum Pattern

Rotate the cam 180° clockwise until the pointed part of the cam covers the orange dot. The steel teeth of the cam are now fixed to the inner walls of the hole. To remove hinge, simply rotate the cam 180° counter-clockwise. Close hinge and pull gently away from door.

The Salice "Rapido" features standard door drilling. Time saving and cost effective: the hinge is fixed directly to the door, no adapter or machine insertion is required. Dowels are permanently fixed to the hinge. No components remain in the door after removal.

#### Fixing

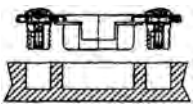

Hinge is easily inserted by hand

#### Insertion

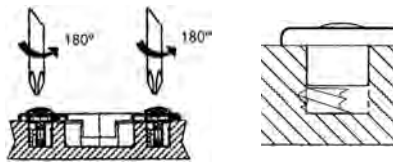

Note: A hand-held screwdriver is the only tool needed (a power screwdriver is not recommended).

See Page 730

### Salice Logica - Tool Free Hinge

Uses Standard 45mm Salice bore pattern

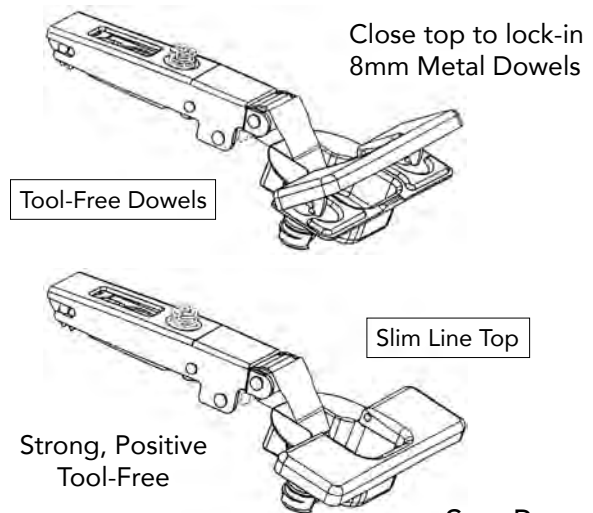
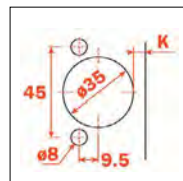
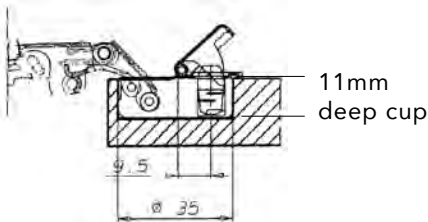

See Page 729

### Salice Titanium Finish - Soft Close or Self Close



C1R6AE6

- Ideal in combination with darker interiors and shades of warm or exotic wood finishes
- Increased corrosion resistance
- Available in Soft-Close and standard self-close



*Titanium has a muted sheen ideal for many shades of wood.*

See Page 744

## EURO CLIP-ON PLATES

## SALICE

### DOMI CLIP ON PLATES - 3 WAY CAM ADJUSTMENT

The Salice DOMI® Mounting Plate has cam adjustment: a quick turn of the frontal adjustment or vertical adjustment screw automatically positions the hinge.

For Use With ALL Salice Hinges. Chart base on using Full Overlay hinges.

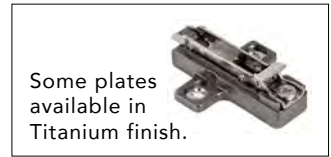

Pack: 300 ea.

Diecast

0mm Side Panel 3/4" Full Overlay	2mm Side Panel 3/4" 11/16" Overlay	3mm Side Panel 5/8" Full Overlay	6mm 1/2" Overlay Partial Overlay	9mm Side Panel 3/4" Half Overlay	12mm Side Panel 5/8" Half Overlay

### 37x32 Wood Screw

	<u>Nickel</u> BAR3R09 \$ 1.81	<u>Nickel</u> BAR3R29 \$ 1.48	<u>Nickel</u> BAR3R39 \$ 1.81	<u>Nickel</u> BAR3R69 \$ 2.31	BAR3R99 \$ 2.75	BAR3RC9 \$ 3.09
	<u>Titanium</u> BAR3R06 \$ 1.73	<u>Titanium</u> BAR3R26 \$ 1.82	<u>Titanium</u> BAR3R36 \$ 1.86	<u>Titanium</u> BAR3R66 \$ 2.10		

see page 712 for even thicker plates

### 37x32 Euro-Screw pre-mounted

	BARGR09/16 \$ 2.10	<u>Nickel</u> BARGR29/16 \$ 1.52	BARGR39/16 \$ 1.82	BARGR69/16 \$ 2.75	BARGR99/16 \$ 2.68	BARGRC9/16 \$ 3.53
	<u>Short Euro:</u> BARGR09/20 \$ 1.62	<u>Titanium</u> BARGR26/16 \$ 1.67	<u>Short Euro:</u> BARGR39/20 \$ 1.77		<u>Short Euro:</u> BARGR99/20 \$ 2.85	

see page 712 for even thicker plates

### 37x32 Expansion Dowels ø 5mm

	BAR4R09/16 \$ 1.72	BAR4R29/16 \$ 1.86	BAR4R39/16 *	BAR4R69/16 *		

### 21+32 Screw-In

	BAP3R09 \$ 1.21	BAP3R29 \$ 1.27	BAP3R39 \$ 1.35	BAP3R69 \$ 1.58	BAP3R99 \$ 1.82	

### 21+32 Euro-Screw pre-mounted

	BAPGR09/16 \$ 1.41	BAPGR29/16 \$ 1.64	BAPGR39/16 \$ 1.84	BAPGR69/16 \$ 1.55		
			<u>Short Euro:</u> BAPGR39/20 \$ 1.75	<u>Short Euro:</u> BAPGR69/20 \$ 1.56		

## SALICE

## EURO PLATES

### CLIP ON PLATES - 3 WAY CAM ADJUSTMENT

The Salice DOMI® Mounting Plate has cam adjustment: a quick turn of the frontal depth adjustment or vertical adjustment screw automatically positions the hinge. The hinge stays tight. For Use With ALL Salice Hinges.

#### 37x32 Wood Screw #6 x 5/8" - #2 Phillips



**Steel.** Pack: 300 ea.

Code	Thickness	List/ea
BAR3L39	3mm	\$ 1.42

#### 37x32 Euro-screw pre-mounted



**Steel.** Pack: 300 ea.

Code	Thickness	List/ea
BARGL09F/16	0mm	\$ 1.58
BARGL39F/16	3mm	1.56

### CLIP ON PLATES

Cam depth adjustment, slotted height adjustment

#### 37x32 Wood Screw



**Diecast.** Pack: 300 ea.

Code	Thickness	List/ea
BAV3EV9F	18mm	\$ 3.34

#### 37x32 Expansion Dowels ø 5mm



**Steel.** Pack: 300 ea.

Code	Thickness	List/ea
BAV4M09F/16	0mm	\$ 1.30

#### 37x32 Euro-screw pre-mounted



**Steel.** Pack: 300 ea.

Code	Thickness	List/ea
BAVGM09F/16	0mm	\$ 1.33
BAVGM29F/16	2mm	1.39
BAVGM39F/16	3mm	1.43

### SLIDE-ON PLATES - 3-WAY CAM ADJUSTMENT

#### 37x32 Wood Screw. Height adjustment by cam



**Diecast.**

Code	Thickness	Ctn	List/ea
B2R3E09/15	0mm	600	\$ 1.12
B2R3E39/15	3mm	600	1.46
B2R3E69/15	6mm	300	1.24

### SLIDE-ON PLATE SYSTEM FOR SPECIAL ASSEMBLY

3-Way Cam Adjustment

#### All Diecast, Wood Screw

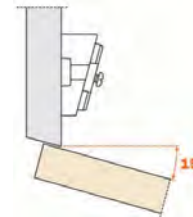

Code	Description	Ctn	List/ea
B2V3BW9/15	15° Angle, screw-on	600	\$ 1.95

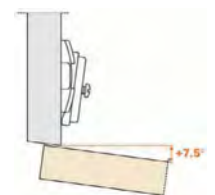
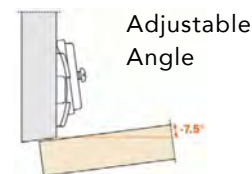

Code	Description	Ctn	List/ea
B2V3BW9R/15	+/- 7.5 Angle, screw-on	600	\$ 3.35

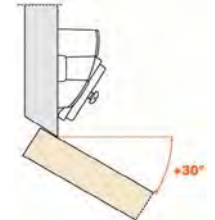
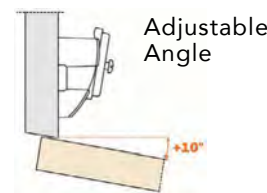

Code	Description	Ctn	List/ea
B2V3BW9S/15	+10 to 30 Angle, screw-on	300	\$ 5.35

## FACE FRAME PLATES

## SALICE

### SALICE CLIP-ON PLATES FOR FACE FRAME APPLICATIONS

Face frame mounting plates (BAU3R) are now available in 1mm, 4mm and 6.5mm thicknesses. Screw holes are either placed at 10mm for centering on 19mm frames (standard) or at 13mm for thicker frames (XR). Both offer a 3rd screw fixing option.

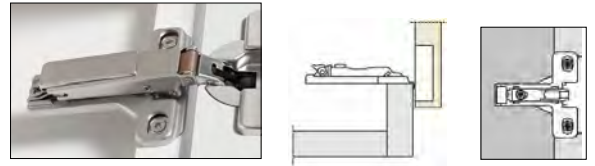

#### Face Frame Plates, 3 Way Cam Adjustment

Pack: 300/ea. All Wood Screw

Overlay based on Full Overlay (A Crank) hinges.

#### Diecast 10x48 Screw-In



Code	Height	Finish	List/ea
BAU3R19	1mm (3/4" Overlay)	Nickel	\$ 2.59
BAU3R49	4mm (5/8" Overlay)	Nickel	2.85
BAU3R69	6mm (1/2" Overlay)	Nickel	2.75
BAU3R16	1mm (3/4" Overlay)	Titanium	2.40
BAU3R46	4mm (5/8" Overlay)	Titanium	2.50

#### Diecast 13x48 Screw-In



13mm setback for thicker frames (e.g. can accommodate an applied veneer)

Code	Height	Finish	List/ea
BAU3R19XR	1mm (3/4" Overlay)	Nickel	\$ 2.68
BAU3R49XR	4mm (5/8" Overlay)	Nickel	2.75
BAU3R69XR	6mm (1/2" Overlay)	Nickel	2.94

#### Steel 10x48 Screw-In



Code	Height	Finish	List/ea
BAU3L19	1mm (3/4" Overlay)	Nickel	\$ 1.84
BAU3L49	4mm (5/8" Overlay)	Nickel	1.96

### INSET FACE FRAME APPLICATION

Clip-on, 3-Way Cam Adjustment  
 Pack: 300 ea.



Code List/ea  
 BAL3R59 \$ 4.56

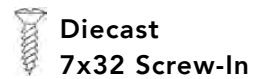

To be used with:  
 Half overlay hinges (G Crank) or  
 1/2" overlay hinges (D Crank) w/ adjustment

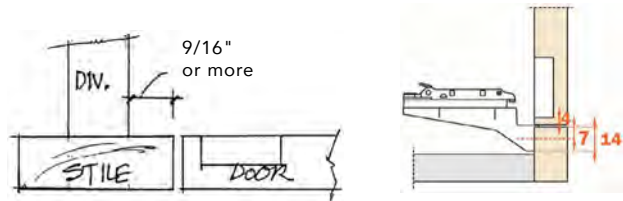

### LARGE OVERLAY FACE FRAME APPLICATION

Clip-on, 3-Way Cam Adjustment  
 Pack: 300 ea.



Code List/ea  
 BAM3R09 \$ 4.80



Hinge	Overlay	Drilling Distance (K)
Full Overlay (A Crank) 110° - 120° opening	1-1/4"	K = 6mm
Full Overlay (A Crank) 94° - 165° opening	1-3/8"	K = 8mm + add 1mm of adj.
Full Overlay (A Crank) 165° + reduction clip S2AF37X3 = 125° opening	1-1/2"	K = 12mm
Full Overlay (A Crank) 165° + reduction clip S2AF37X3 = 125° opening	1-9/16"	K = 14mm



# SALICE

# THICK EURO PLATES

## HINGE AND MOUNTING PLATE SELECTION GUIDE FOR INSET DOORS ON FACE FRAME CABINETS

The BAR thick mounting plate system has been developed to offer the appropriate mounting plate thickness for inset doors with face frame cabinets. This eliminates the need to "build up" to match the face frame interspace (IS) dimension.

### 3 WAY CAM ADJUSTMENT

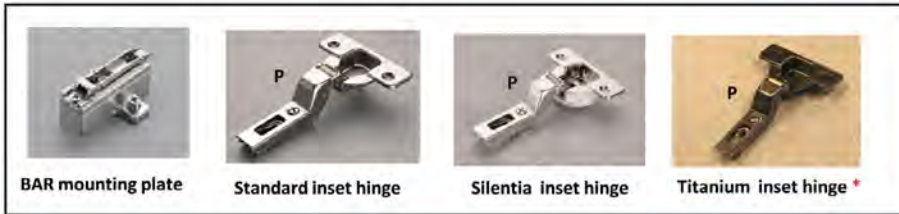

BARGRV9 - 18mm thick

Select an Inset style (P crank) hinge and the matching mounting plate thickness for your cabinet design

<p><b>H = 3</b>                  IS = Flush                  P = Inset hinge                  H = 3mm plate                  K = 4mm                  A = 2.5mm                  Adjust: +1.5mm</p>	<p><b>H = 6</b>                  IS = 1/16"                  P = Inset hinge                  H = 6mm plate                  K = 4mm                  A = 2.5mm</p>	<p><b>H = 6</b>                  IS = 1/8"                  P = Inset hinge                  H = 6mm plate                  K = 4mm                  A = 2.5mm                  Adjust: +1.5mm</p>																														
<p><b>H = 9</b>                  IS = 1/4"                  P = Inset hinge                  H = 9mm plate                  K = 4mm                  A = 2.5mm                  Adjust: +1.5mm</p>	<p><b>H = 12</b>                  IS = 3/8"                  P = Inset hinge                  H = 12mm plate                  K = 4mm                  A = 2.5mm                  Adjust: +2.5mm</p>	<p><b>H = 18</b>                  IS = 1/2"                  P = Inset hinge                  H = 18mm plate                  K = 4mm                  A = 2.5mm                  Adjust: -0.5mm</p>																														
<p><b>H = 24</b>                  IS = 3/4"                  P = Inset hinge                  H = 24mm plate                  K = 4mm                  A = 2.5mm                  Adjust: -0.5mm</p>	<p><b>H = 27</b>                  IS = 7/8"                  P = Inset hinge                  H = 27mm plate                  K = 4mm                  A = 2.5mm                  Adjust: -0.5mm</p>	<p><b>H = 30</b>                  IS = 1"                  P = Inset hinge                  H = 30mm plate                  K = 4mm                  A = 2.5mm                  Adjust: 0.0mm</p>																														
<p><b>H = 30</b>                  IS = 1-1/8"                  P = Inset hinge                  H = 30mm plate                  K = 4mm                  A = 2.5mm                  Adjust: +3.0mm</p>	<h3>THICK MOUNTING PLATES</h3> <p>With Wood Screws</p> <table border="1"> <thead> <tr> <th>Code</th> <th>Thickness</th> <th>List/ea</th> </tr> </thead> <tbody> <tr><td>BAR3R39</td><td>3mm</td><td>\$ 1.81</td></tr> <tr><td>BAR3R69</td><td>6mm</td><td>2.31</td></tr> <tr><td>BAR3R99</td><td>9mm</td><td>2.75</td></tr> <tr><td>BAR3RC9</td><td><b>12mm</b></td><td>3.09</td></tr> <tr><td>BAR3RV9*</td><td><b>18mm</b></td><td>4.28</td></tr> <tr><td>BAR3RZ9</td><td><b>21mm</b></td><td>4.21</td></tr> <tr><td>BAR3RY9</td><td><b>24mm</b></td><td>4.47</td></tr> <tr><td>BAR3RU9</td><td><b>27mm</b></td><td>4.77</td></tr> <tr><td>BAR3RM9</td><td><b>30mm</b></td><td>5.02</td></tr> </tbody> </table>		Code	Thickness	List/ea	BAR3R39	3mm	\$ 1.81	BAR3R69	6mm	2.31	BAR3R99	9mm	2.75	BAR3RC9	<b>12mm</b>	3.09	BAR3RV9*	<b>18mm</b>	4.28	BAR3RZ9	<b>21mm</b>	4.21	BAR3RY9	<b>24mm</b>	4.47	BAR3RU9	<b>27mm</b>	4.77	BAR3RM9	<b>30mm</b>	5.02
Code	Thickness	List/ea																														
BAR3R39	3mm	\$ 1.81																														
BAR3R69	6mm	2.31																														
BAR3R99	9mm	2.75																														
BAR3RC9	<b>12mm</b>	3.09																														
BAR3RV9*	<b>18mm</b>	4.28																														
BAR3RZ9	<b>21mm</b>	4.21																														
BAR3RY9	<b>24mm</b>	4.47																														
BAR3RU9	<b>27mm</b>	4.77																														
BAR3RM9	<b>30mm</b>	5.02																														
		<h3>THICK MOUNTING PLATES</h3> <p>With Pre-mounted Euro Screws</p> <table border="1"> <thead> <tr> <th>Code</th> <th>Thickness</th> <th>List/ea</th> </tr> </thead> <tbody> <tr><td>BARGR39/16</td><td>3mm</td><td>\$ 1.82</td></tr> <tr><td>BARGR69/16</td><td>6mm</td><td>2.75</td></tr> <tr><td>BARGR99/16</td><td>9mm</td><td>2.68</td></tr> <tr><td>BARGRC9/16</td><td><b>12mm</b></td><td>3.53</td></tr> <tr><td>BARGRV9/16</td><td><b>18mm</b></td><td>5.16</td></tr> <tr><td>BARGRZ9/16</td><td><b>21mm</b></td><td>4.52</td></tr> <tr><td>BARGRY9/16</td><td><b>24mm</b></td><td>5.85</td></tr> <tr><td>BARGRU9/16</td><td><b>27mm</b></td><td>5.09</td></tr> <tr><td>BARGRM9/16</td><td><b>30mm</b></td><td>5.34</td></tr> </tbody> </table>	Code	Thickness	List/ea	BARGR39/16	3mm	\$ 1.82	BARGR69/16	6mm	2.75	BARGR99/16	9mm	2.68	BARGRC9/16	<b>12mm</b>	3.53	BARGRV9/16	<b>18mm</b>	5.16	BARGRZ9/16	<b>21mm</b>	4.52	BARGRY9/16	<b>24mm</b>	5.85	BARGRU9/16	<b>27mm</b>	5.09	BARGRM9/16	<b>30mm</b>	5.34
Code	Thickness	List/ea																														
BARGR39/16	3mm	\$ 1.82																														
BARGR69/16	6mm	2.75																														
BARGR99/16	9mm	2.68																														
BARGRC9/16	<b>12mm</b>	3.53																														
BARGRV9/16	<b>18mm</b>	5.16																														
BARGRZ9/16	<b>21mm</b>	4.52																														
BARGRY9/16	<b>24mm</b>	5.85																														
BARGRU9/16	<b>27mm</b>	5.09																														
BARGRM9/16	<b>30mm</b>	5.34																														

- IS: Interspace (From side to frame edge)
- B: Mounting Plate
- H: Mounting Plate thickness
- K: Edge bore distance
- A: Gap
- P: Inset style, full crank hinge



# THICK DOOR HINGE

# SALICE 94° HINGE

## SALICE 94° THICK DOOR HINGE

Series 200

Mounts thick doors up to 1-1/4" (32mm). For thick doors with special profiles. 11mm deep metal cup. Possible boring distance on the door (K): from 3 to 9mm for doors with square or rounded edges. Compatible with slide-on or clip-on baseplates.

### Features:

- 35mm Cup Dia.
- 11mm Cup Depth
- Automatic Door Adjustments
- Constant gap between cabinet and front during overlay adjustment of doors (exclusive to Salice)
- ANSI, BHMA rated; ISO 9001. WI approved.



How much space does a door need to open?

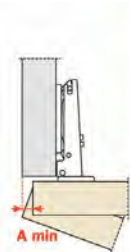

T=	19	20	21	22	23	24	25	26	27	28	29	30	31	32	33	34	35
K=3	A= 0.1	0.2	0.3	0.4	0.5	0.7	0.8	1.0	1.6	2.6	3.5	4.5	5.4	6.4	7.4	8.3	9.3
K=4	A= 0.1	0.2	0.3	0.4	0.5	0.7	0.8	1.0	1.2	1.9	2.8	3.8	4.7	5.7	6.6	7.6	8.6
K=5	A= 0.1	0.2	0.3	0.4	0.5	0.7	0.8	1.0	1.2	1.4	2.2	3.1	4.1	5.0	5.9	6.9	7.8
K=6	A= 0.1	0.2	0.3	0.4	0.5	0.6	0.8	1.0	1.2	1.4	1.7	2.6	3.5	4.4	5.3	6.2	7.2
K=7	A= 0.1	0.2	0.3	0.4	0.5	0.6	0.8	1.0	1.1	1.3	1.6	2.1	3.0	3.8	4.7	5.6	6.5
K=8	A= 0.1	0.2	0.3	0.4	0.5	0.6	0.8	0.9	1.1	1.3	1.6	1.8	2.5	3.3	4.2	5.1	6.0
K=9	A= 0.1	0.2	0.3	0.4	0.5	0.6	0.8	0.9	1.1	1.3	1.5	1.8	2.1	2.9	3.7	4.6	5.4

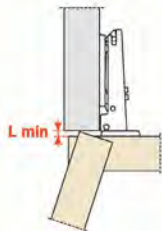

K=	3	4	5	6	7	8	9
L=	0.0	0.0	0.0	0.0	0.0	0.3	1.3

The above values are calculated on the assumption that the doors have square edges. They are reduced if the doors have radiussed edges.

### Key

- S = thickness of the cabinet side
- D = required door overlay
- T = max. door thickness
- K = drilling distance
- A\* = reveal
- L = gap between door and carcass
- H = height of the mounting plate

\* either for a single door on the edge of a case or a pair of doors on a common partition.

An appropriate molding of the door reduces the values of "A" and "L"

### "C" value

For this application, please use the following formula to calculate the maximum thickness which can be opened without touching the cabinet side or adjacent door, always considering the table of "L-K-T" values

$$C = 23 + K + A$$

$$C = 23 + K + A$$

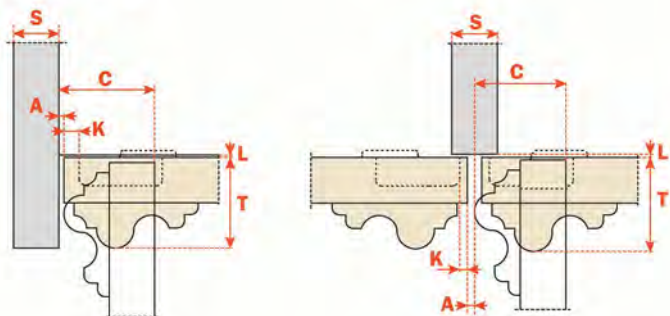

## SALICE 94° HINGE

## THICK DOOR HINGE

### Full Overlay / "A" Crank

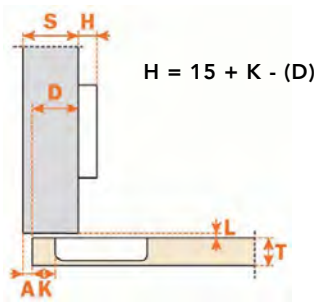

### 1/2" Overlay / Face Frame / "D" Crank

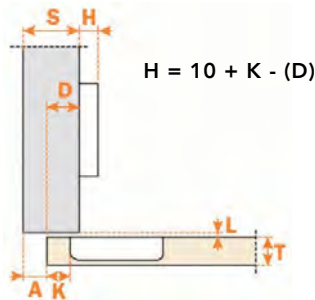

### Half Overlay / "G" Crank

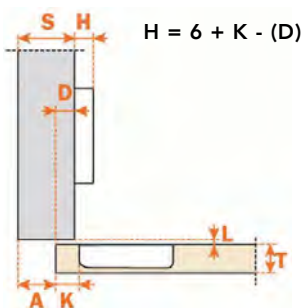

### Inset / "P" Crank

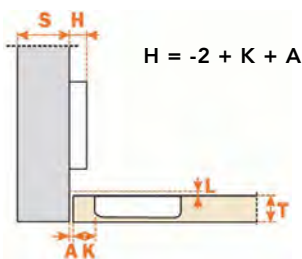

### SALICE 94° THICK DOOR HINGE

- 35mm cup dia, 11mm deep
- Clip-on or Slide-on depending on baseplate
- For thick doors up to 32mm thick (1-1/4")

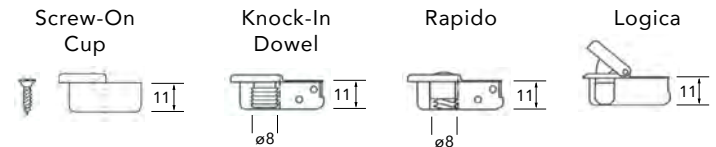

Pack: 300 ea.

Code	Description	List/ea
C2PAA99	Full Overlay, F/S, Screw-In	\$ 2.93
C2RAA99	Full Overlay, F/S, Dowel	3.33
C2PBA99	Full Overlay, S/C, Screw-In	3.42
C2RBA99	Full Overlay, S/C, Dowel	5.63
C2RBD99	1/2" Overlay, S/C, Dowel	4.90
C2RAG99	Half Overlay, F/S, Dowel	3.49
C2PBG99	Half Overlay, S/C, Screw-In	3.21
C2RBG99	Half Overlay, S/C, Dowel	5.46
C2PAP99	Inset, F/S, Screw-In	4.61
C2RAP99	Inset, F/S, Dowel	3.00
C2PBP99	Inset, S/C, Screw-In	3.58
C2RBP99	Inset, S/C, Dowel	7.54
C27BA99	Rapido, Full Overlay, S/C	3.77
C27BP99	Rapido, Inset, S/C	3.71
C2JBA99	Logica, Full Overlay, S/C	4.19
C2JBP99	Logica, Inset, S/C	4.53

F/S = Free Swinging      S/C = Self Closing

### Hinge Reduction Clip

Code	Description	List/C
S2A637XF	Reduction Clip (to 86°)	\$ 50.06

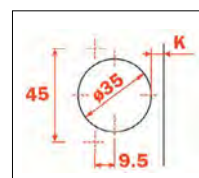

Screw-In

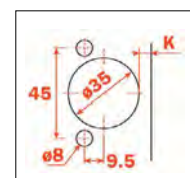

Knock-In Dowel, Rapido, Logica

## SILENTIA+ SOFT CLOSE 94°

### Silentia +

- **2 Pistons per cup** for smooth control on many sizes of doors

- **3 Speeds:** Selection Switch allows for slow, med & fast **soft** closing

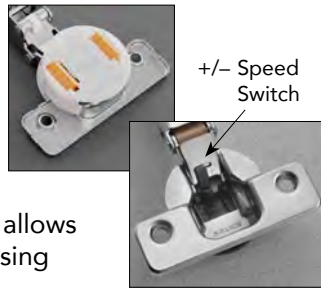

### SALICE 94° SOFT CLOSE HINGES - THICK DOOR

Silentia+ Soft Close Series 200, Thick Door Hinge (3/4" to 1-1/4" thickness)  
 94°, 15.5mm deep cup, 35mm Bore

7 Soft Close action is concealed within the hinge cup.

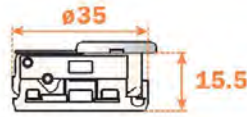

#### Full Overlay

C2RBAE9 - Dowel C2JBAE9 - Logica  
 C27BAE9 - Rapido

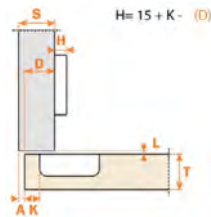

#### Half Overlay

C2RBGE9

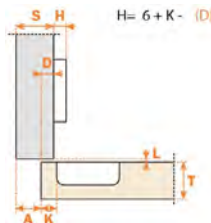

#### Inset

C2RBPE9

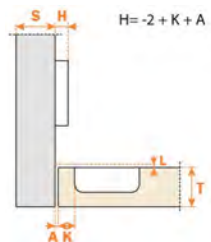

Thick Door Hinges, Pack: 300 each.

Code	Description	List/ea
C2RBAE9	Full Overlay, Dowel	\$ 5.91
C2RBGE9	Half-Overlay, Dowel	5.88
C2RBPE9	Inset, Dowel	6.55
C27BAE9	Full Overlay, Rapido	6.62
C2JBAE9	Full Overlay, Logica (to 1-3/8" thick)	7.49

## SALICE

### SHORT ARM SERIES 300 HINGES AND PLATES

Short arm concealed hinges, 45mm operating profile. 94° opening angle, 11mm deep cup, 35mm cup dia.

Possible drilling distance on the door (K): from 3 to 9mm. Full overlay, Self-closing, Dowelled.

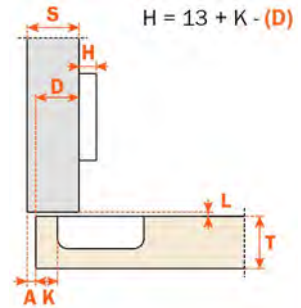
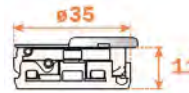

Short Arm Hinges, Pack: 300 each.

Code	Description	List/ea
C3RBA99	Full Overlay, Dowel	\$ 18.13

**Slide-on Mounting Plate** Series 300 made of steel with holes for wood screw. Height adjustment by cam +/- 1.5 mm, 20x32 mm drilling. For use with above hinge.

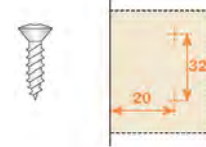

Slide-on Plates, Pack: 300 ea.

Code	Description	List/ea
B383E09/15	0mm, screw-on	\$ 3.24
B383E69/15	6mm, screw-on	3.66

**Spacers** for above Series 300 Slide-on Plates. Stocking 3mm and 13mm.



Pack: 300 ea.

Code	Description	List/ea
S38X8639	Spacer, 3mm	\$ 1.77
S38X86D9	Spacer, 13mm	2.63

# SALICE

# THIN DOOR HINGE

## SALICE 105° THIN DOOR HINGE

105°, for thin doors down to 10mm. Metal cup is 8mm deep. Clip-on or slide-on depending on baseplate used. Self-closing, Screw-on. Possible drilling distance on the door (K): 3 to 6mm. Compatible with all traditional Series 200 mounting plates and with all DOMI® snap-on mounting plates.



Code	Description	Ctn	List/ea
C1P6A99	105°, Full Overlay	300	\$ 3.50
C1P6G99	105°, Half Overlay	300	3.70

### Features:

- **Thin 8mm cup**
- Automatic Door Adjustments
- Constant gap between cabinet and front during overlay adjustment of doors (*exclusive to Salice*)
- Available with smooth cam-drive adjustments for height and depth (*exclusive to Salice*)
- ANSI, BHMA, rated; ISO 9001. WIC Approved.

### Full Overlay / "A" Crank

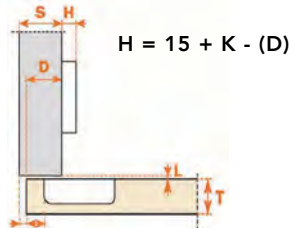

### Projection of the Door

Projection of the door from the cabinet side at the max. opening. The figures are based on a straight arm hinge, H=0mm thickness of mounting plate and K value = 3mm.

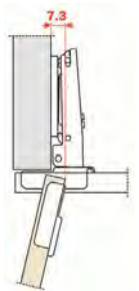

### Half Overlay / "G" Crank

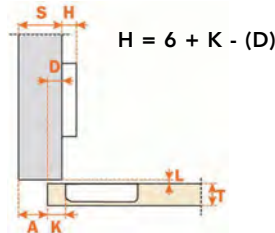

### "C" Value

With this formula you can obtain the max. thickness of the molded door that can be opened without touching adjacent carcass sides, doors or walls, while bearing in mind the below L-K-T values.

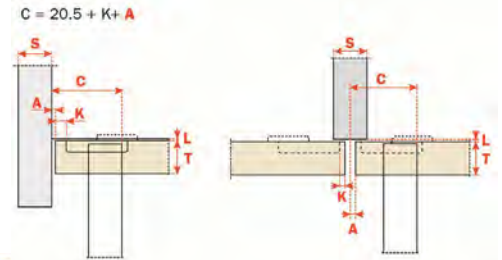

How much space does a door need to open?

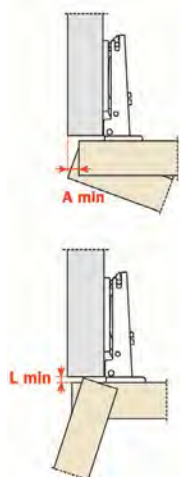

T=	10	11	12	13	14	15	16	17	18	19	20	
K=3	A=	0.2	0.3	0.4	0.6	0.8	1.0	1.3	1.6	1.9	2.3	2.7
K=4	A=	0.2	0.3	0.4	0.6	0.8	1.0	1.3	1.6	1.9	2.2	2.6
K=5	A=	0.1	0.3	0.4	0.6	0.8	1.0	1.2	1.5	1.8	2.1	2.5
K=6	A=	0.1	0.2	0.4	0.5	0.7	1.0	1.2	1.5	1.8	2.1	2.4

T=	10	11	12	13	14	15	16	17	18	19	20
K=3	L=	0.0	0.0	0.0	0.0	0.0	0.0	0.0	0.0	0.1	0.3
K=4	L=	0.0	0.0	0.0	0.0	0.2	0.4	0.6	0.7	0.9	1.2
K=5	L=	0.5	0.7	0.9	1.0	1.2	1.4	1.5	1.7	1.9	2.2
K=6	L=	1.5	1.7	1.8	2.0	2.2	2.4	2.5	2.7	2.9	3.2

The above values are calculated on the assumption that the doors have square edges. They are reduced if the doors have radiussed edges.

### Key

- S = thickness of the cabinet side
- D = required door overlay
- T = max. door thickness
- K = drilling distance
- A\* = reveal
- L = gap between door and carcass
- H = height of the mounting plate

\* either for a single door on the edge of a case or a pair of doors on a common partition.

# SILENTIA+ SOFT CLOSE 105°

# SALICE

## SALICE SILENTIA+ SOFT CLOSE HINGE

Series 100: 105° Opening

Possible drilling distance on the door (K): from 3 to 6mm.  
 Compatible with all traditional Series 200 mounting plates  
 and with all DOMI® snap-on mounting plates.

- 15mm Min. Door Thickness
- 12mm deep cup
- 105° opening
- For Doors 15 to 20mm Thick

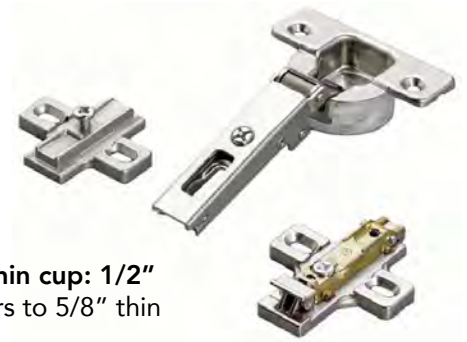
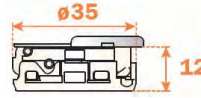

- **Shallow bore / Thin cup: 1/2"**  
 (12mm). Fits doors to 5/8" thin

7

### Space needed to open the door

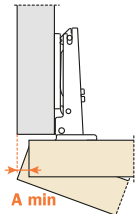

T=	15	16	17	18	19	20
K=3 <b>A=</b>	1.0	1.0	1.2	1.4	1.6	1.9
K=4 <b>A=</b>	0.9	1.0	1.2	1.3	1.5	1.8
K=5 <b>A=</b>	0.9	1.0	1.1	1.2	1.5	1.8
K=6 <b>A=</b>	0.9	1.0	1.1	1.2	1.4	1.7

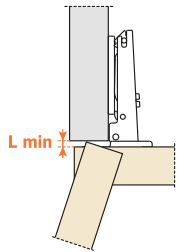

T=	15	16	17	18	19	20
K=3 <b>L=</b>	0.0	0.0	0.0	0.0	0.1	0.3
K=4 <b>L=</b>	0.4	0.6	0.7	0.9	1.1	1.2
K=5 <b>L=</b>	1.0	1.0	1.2	1.8	2.0	2.0
K=6 <b>L=</b>	1.6	1.8	2.0	2.1	2.3	2.5

The above values are calculated on doors with a 1 mm radius.  
 They are reduced if the doors have greater radiussed edges.

### Key

- S = thickness of the cabinet side
- D = required door overlay
- T = max. door thickness
- K = drilling distance
- A\* = reveal
- L = gap between door and carcass
- H = height of the mounting plate

\* either for a single door on the edge of a case or a pair of doors on a common partition.

### Protrusion of the door

Projection of the door from the cabinet side at the max. opening. The figures are based on a straight arm hinge, H=0mm thickness of mounting plate and K value = 3mm.

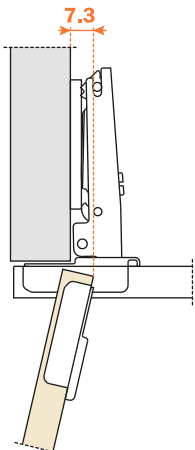

### "C" value

With this formula you can obtain the max. thickness of the moulded door that can be opened without touching adjacent cabinet sides, doors or walls, while bearing in mind the above L-K-T values.

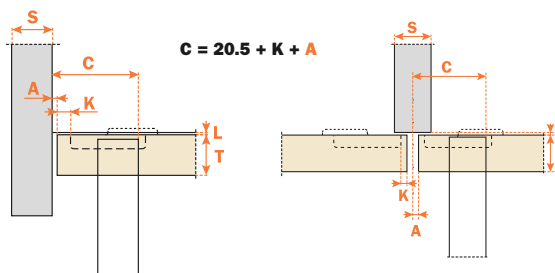

## SALICE

### Silentia +

- **2 Pistons per cup** for smooth control on many sizes of doors
- **3 Speeds:** Selection Switch allows for slow, med & fast **soft** closing

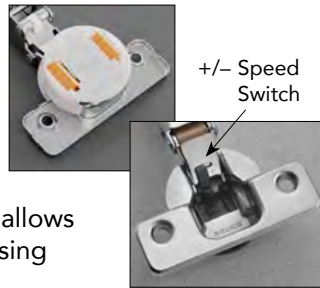

#### Full Overlay / Arm 0

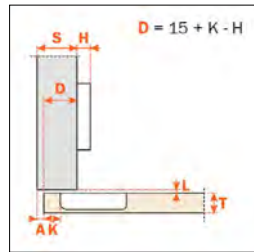

#### 1/2" Overlay / Arm 5

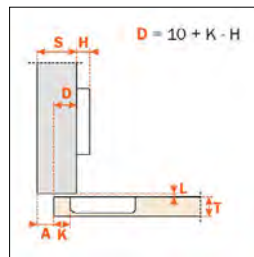

#### Half Overlay / Arm 9

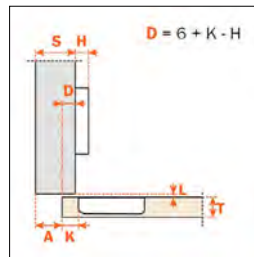

#### Inset / Arm 17

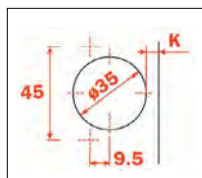
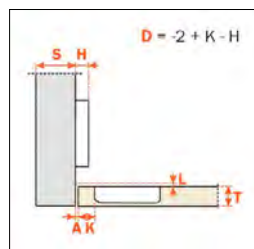

Screw-In

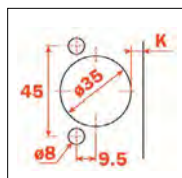

Knock-In  
 Dowel,  
 Rapido,  
 Logica

## SILENTIA+ SOFT CLOSE 105°

### SALICE SILENTIA+ SOFT CLOSE HINGE

Series 100: 105° Opening

- 15mm Min. Door Thickness
- 12mm deep cup
- 105° opening
- For Doors 15 to 20mm Thick

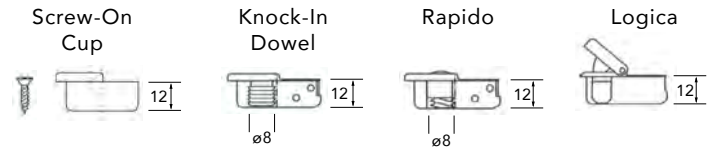
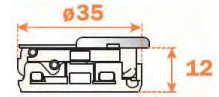

Pack: 300 ea.

Code	Description	List/ea
C1R6AE9	Full Overlay, Dowel	\$ 5.55
C1P6AE9	Full Overlay, Screw-On	5.39
C176AE9	Full Overlay, Rapido	4.58
C1J6AE9	Full Overlay, Logica	5.08
C1R6DE9	1/2" Overlay, Dowel	5.64
C1P6DE9	1/2" Overlay, Screw-On	5.50
C176DE9	1/2" Overlay, Rapido	4.71
C1J6DE9	1/2" Overlay, Logica	5.16
C1R6GE9	Half Overlay, Dowel	5.66
C1P6GE9	Half Overlay, Screw-On	6.08
C176GE9	Half Overlay, Rapido	5.10
C1J6GE9	Half Overlay, Logica	5.25
C1R6PE9	Inset, Dowel	5.91
C1P6PE9	Inset, Screw-On	5.66
C176PE9	Inset, Rapido	4.88
C1J6PE9	Inset, Logica	5.37

### TITANIUM FINISH

### SALICE SILENTIA+ SOFT CLOSE HINGE

Series 100: 105° Opening



Same hinge in LH column, except in a titanium finish.

More Titanium hinges on page 744.

Dowelled, Pack: 300 ea.

Code	Description	List/ea
C1R6AE6	Titanium Silentia 105°, Full Overlay	\$ 5.78
C1R6DE6	Titanium Silentia 105°, 1/2" Overlay	5.98
C1R6GE6	Titanium Silentia 105°, Half Overlay	6.44
C1R6PE6	Titanium Silentia 105°, Inset	6.80

# SALICE 110° HINGE

## SALICE 110° HINGE

Series 200

Neat gaps and clearance with overlay and inset doors that run 5/8" to slightly thicker than 13/16". 11mm deep metal cup. Compatible with clip-on or slide-on mounting plates. Possible Boring Distance on the door (K): from 3 to 6mm.

### Features:

- Automatic Door Adjustments
- Constant gap between cabinet and front during overlay adjustment of doors (exclusive to Salice)
- Available with smooth cam-drive adjustments for height and depth (exclusive to Salice)
- ANSI, BHMA rated; ISO 9001. WI approved.
- Self-Close, Dowel version available in Titanium finish.



7

How much space does a door need to open?

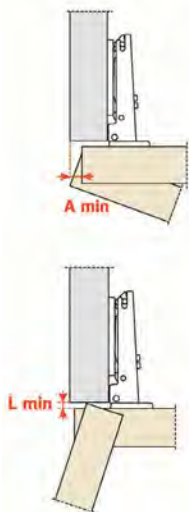

T=	16	17	18	19	20	21	22	23	24	25	26
K=3 <b>A=</b>	0.5	0.7	0.9	1.2	1.5	1.8	2.4	3.7	5.1	6.5	7.8
K=4 <b>A=</b>	0.5	0.7	0.9	1.2	1.5	1.8	2.1	2.7	4.1	5.5	6.8
K=5 <b>A=</b>	0.5	0.7	0.9	1.2	1.5	1.8	2.1	2.6	3.1	4.1	5.4
K=6 <b>A=</b>	0.5	0.7	0.9	1.2	1.5	1.8	2.1	2.5	3.0	3.5	4.4

T=	16	17	18	19	20	21	22	23	24	25	26
K=3 <b>L=</b>	0.0	0.0	0.0	0.0	0.2	0.5	0.8	1.1	1.4	1.7	1.9
K=4 <b>L=</b>	0.0	0.0	0.3	0.6	0.9	1.2	1.4	1.7	2.0	2.3	2.6
K=5 <b>L=</b>	1.1	1.3	1.6	1.8	2.1	2.3	2.6	2.9	3.1	3.4	3.6
K=6 <b>L=</b>	2.0	2.3	2.5	2.8	3.1	3.3	3.6	3.8	4.1	4.3	4.6

The above values are calculated on the assumption that the doors have square edges. They are reduced if the doors have radiussed edges.

### Key

- S = thickness of the cabinet side
- D = required door overlay
- T = max. door thickness
- K = drilling distance
- A\* = reveal
- L = gap between door and carcass
- H = height of the mounting plate

\* either for a single door on the edge of a case or a pair of doors on a common partition.

An appropriate molding of the door reduces the values of "A" and "L"

"C" value

For this application, please use the following formula to calculate the maximum thickness which can be opened without touching the cabinet side or adjacent door, always considering the table of "L-K-T" values

$$C = 20 + K + A$$

$$C = 20 + K + A$$

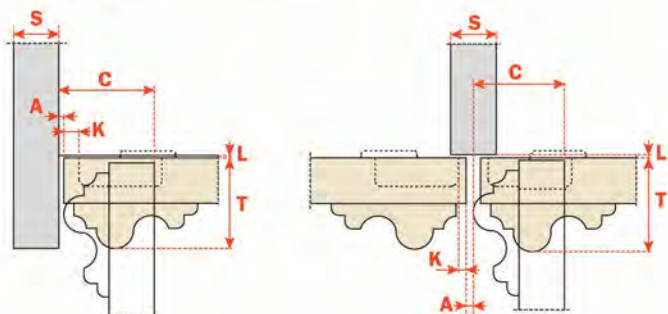



## SALICE 110° HINGE

### Full Overlay / "A" Crank

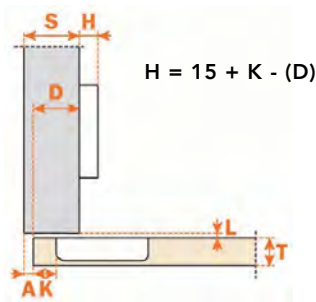

### 1/2" Overlay / "D" Crank

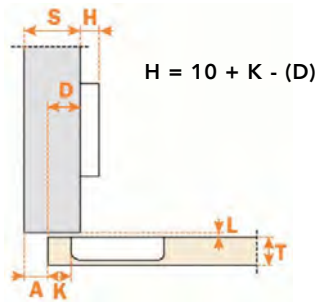

### Half Overlay / "G" Crank

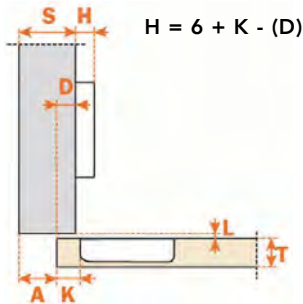

### Inset / "P" Crank

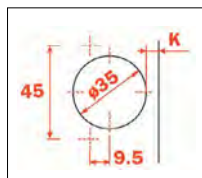
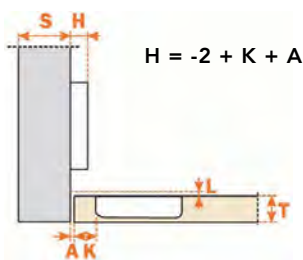

Screw-In

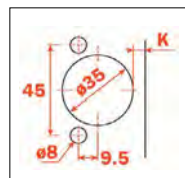

Knock-In  
 Dowel,  
 Rapido,  
 Logica

### SALICE 110° OPENING HINGE

- 35mm cup
- Self-Close & Free Swing
- Clip-on or Slide-on depending on baseplate
- Tight gaps on doors up to 13/16" Thick
- Self-Close w/ dowel available in Titanium finish

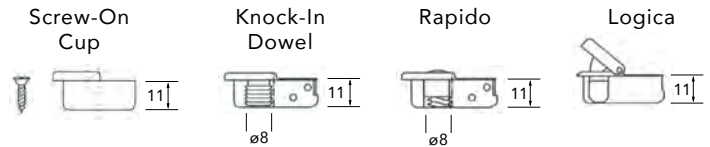

Pack: 300 ea.

Code	Description	List/ea
C2P4A99	Full Overlay, F/S, Screw-In	\$ 2.95
C2P6A99	Full Overlay, S/C, Screw-In	3.34
C2R4A99	Full Overlay, F/S, Dowel	3.20
C2R6A99	Full Overlay, S/C, Dowel	2.69
C2R6A66	Titanium, F/O, S/C, Dowel	3.42
C2R6D99	1/2" Overlay, S/C, Dowel	3.65
C2R6D66	Titanium, 1/2" Ov, S/C, Dowel	4.20
C2P6D99	1/2" Overlay, S/C, Screw-In	2.75
C2P4G99	Half Overlay, F/S, Screw-In	2.63
C2P6G99	Half Overlay, S/C, Screw-In	2.62
C2R4G99	Half Overlay, F/S, Dowel	3.28
C2R6G99	Half Overlay, S/C, Dowel	3.48
C2R6G66	Titanium, Half Ov, S/C, Dowel	3.90
C2R6P99	Inset, S/C, Dowel	4.05
C2R6P66	Titanium, Inset, S/C, Dowel	4.86
C2R4P99	Inset, F/S, Dowel	3.27
C2P6P99	Inset, S/C, Screw-In	3.54

### Rapido allows Rapid Inset & Removal of Hinge

C276A99	Rapido, Full Overlay, S/C	\$ 3.95
C274A99	Rapido, Full Overlay, F/S	3.59
C276G99	Rapido, Half Overlay, S/C	3.43
C274P99	Rapido, Inset, F/S	4.29
C276D99	Rapido, 1/2" Overlay, S/C	3.32

### Logica allows "Tool-Free" Hinge insertion

C2J6A99	Logica, Full Overlay, S/C	\$ 4.83
C2J4A99	Logica, Full Overlay, F/S	4.37
C2J6G99	Logica, Half Overlay, S/C	4.24
C2J6P99	Logica, Inset, S/C	4.91
C2J6D99	Logica, 1/2" Overlay, S/C	4.42

F/S = Free Swinging

S/C = Self Closing

**SILENTIA+ SOFT CLOSE 110°**

**SALICE**

**Silentia +**

- **2 Pistons per cup** for smooth control on many sizes of doors
- **3 Speeds:** Selection Switch allows for slow, med & fast **soft** closing

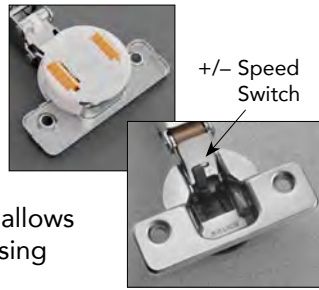

**Full Overlay / Arm 0**

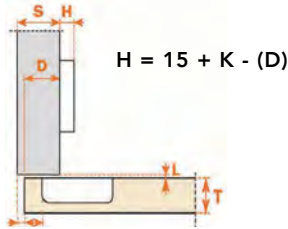

**1/2" Overlay / Arm 5**

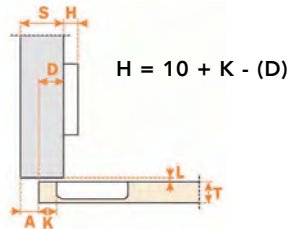

**Half Overlay / Arm 9**

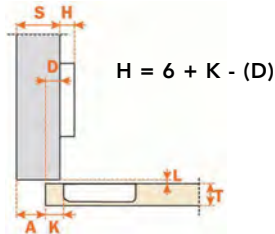

**Inset / Arm 17**

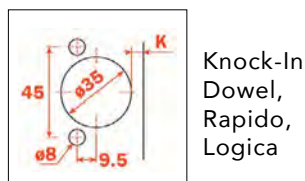
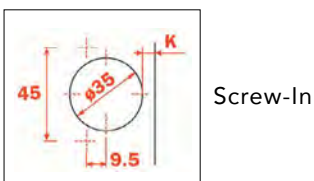
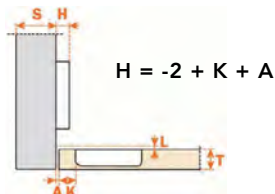

**SALICE 110° SOFT CLOSE HINGES**

Silentia+ Soft Close Series 700, 110° (17/32" Depth Cup) For 16-26mm Thick Doors. Soft Close action is concealed within the hinge cup. Same gap chart as std. 110° - see page 719.

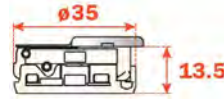

700 Series drills at 13.5 (17/32") depth

Pack: 300 ea.

Code	Description	List/ea
C7R6AE9	Full Overlay, Dowel	\$ 6.22
C7R6AE6	" " " ", Titanium finish	6.41
C7P6AE9	Full Overlay, Screw-On	5.91
C776AE9	Full Overlay, Rapido	6.11
C7J6AE9	Full Overlay, Logica	7.37
C7R6DE9	1/2" Overlay, Dowel	6.10
C7P6DE9	1/2" Overlay, Screw-On	6.01
C776DE9	1/2" Overlay, Rapido	6.37
C7J6DE9	1/2" Overlay, Logica	7.23
C7R6GE9	Half Overlay, Dowel	6.23
C7P6GE9	Half Overlay, Screw-On	6.06
C776GE9	Half Overlay, Rapido	6.59
C7J6GE9	Half Overlay, Logica	7.68
C7R6PE9	Inset, Dowel	6.45
C7P6PE9	Inset, Screw-On	6.32
C776PE9	Inset, Rapido	6.62
C7J6PE9	Inset, Logica	7.91

**CLEAR SPACERS FOR SILENTIA**

Spacer to reduce the drilling depth for 94°, 105° and 110° hinges.



Code	Description	List/C
S2XX86AT	1.2mm Spacer for Silentia	\$ 39.47
S2XX86KT	1.8mm Spacer for Silentia	43.27

**DEPTH GAUGE FOR SILENTIA**

Can be used to VERIFY the correct drilling depth for the 700 Series Silentia hinges (13.5mm). A simple hand-held gauge with pre-set 13.5mm depth, 35mm in diameter.



If the top surface of gauge rests either flush or below the door surface, (check by running your finger over the edge of the hole with the tool inserted) the door has been drilled deep enough.

D7A6ACYSN List \$ 3.92/ea.

**SALICE**

**110° "SUPER" HINGE**

**SALICE 110° "SUPER" HINGE**

This special purpose hinge has 7 pivot points. Works well with thick doors, large tabs (K), 3/8" inset, thick door inset, etc. Shallow 9mm cup depth. Self-closing and Soft-closing available, Screw-in.

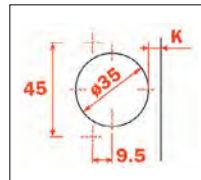

Cup depth 9mm,  
 Opening 110°  
 K = 3 to 18mm  
 (on square edge doors)

**SOFT CLOSE SMOVE**

Works with CBP2AC9

Easily converts 'Super' hinge CBP2AC9 to soft close.

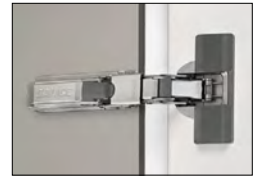

Lift and remove cover from hinge arm with flat blade screwdriver. Insert piston frontally, then press lightly on the back to affix.



DBDESN6

Self Close	Description	Ctn	List/ea
CBP2AC9	110° Hinge for doors with special profiles & drilling requirements	150	\$ 15.01
Soft Close	Description	Ctn	List/ea
CBP2AE9	Same hinge as above, except with Soft-Close integrated into hinge arm	150	18.08

Code	Description	List/ea
DBDESN6	Soft-Close for CBP2AC9	\$ 4.24

**Series B 'Super' Hinge Assembly Examples**

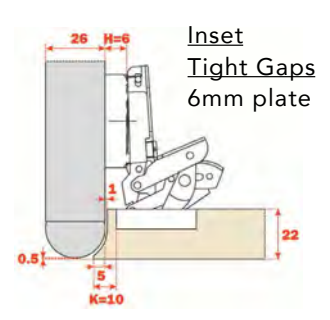
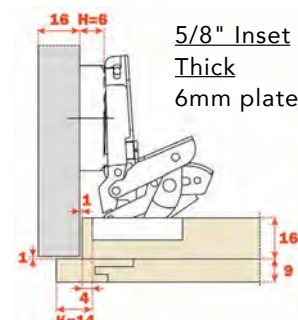
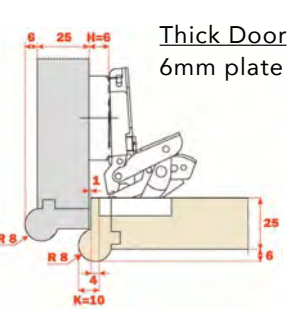
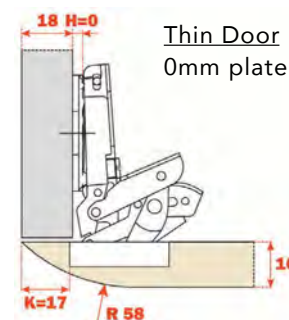
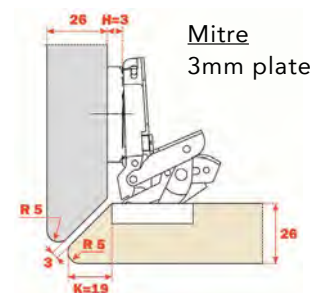
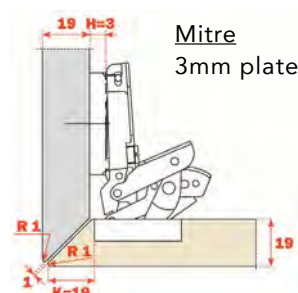
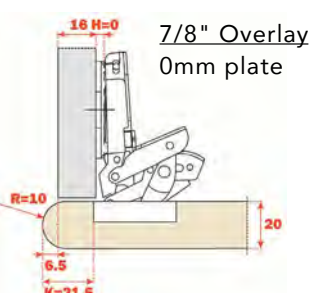
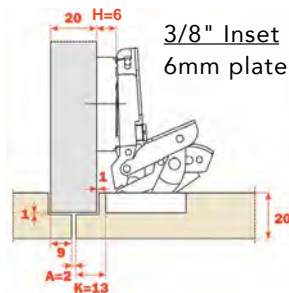
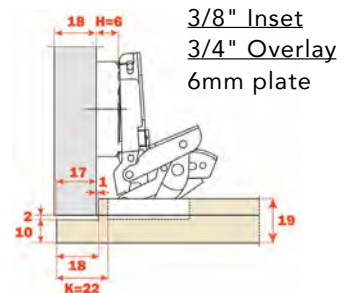
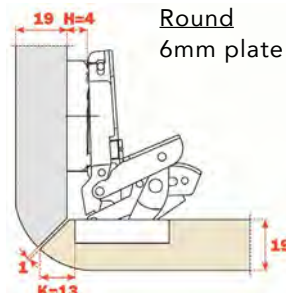
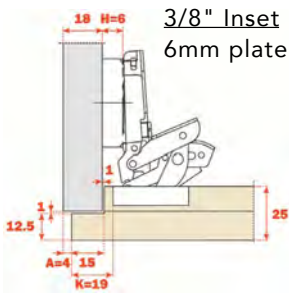



# SALICE 120° HINGE

## SALICE 120° HINGE

Series 200

Popular opening angle easily mounts 3/4" thick doors with neat gaps and good case clearance. 11mm deep metal cup. Compatible with clip-on or slide-on mounting plates. Possible Boring Distance on the door (K): from 3 to 6mm.

### Features:

- Automatic Door Adjustments
- Constant gap between cabinet and front during overlay adjustment of doors (exclusive to Salice)
- Available with smooth cam-drive adjustments for height and depth (exclusive to Salice)
- ANSI, BHMA rated; ISO 9001. WI approved.



How much space does a door need to open?

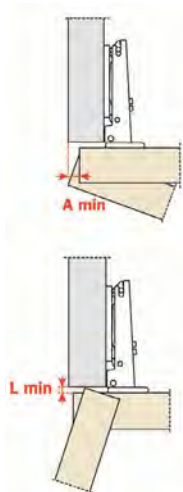

	T=	16	17	18	19	20	21	22	23	24	25	26
K=3	<b>A=</b>	1.0	1.3	1.6	1.9	2.2	3.5	5.0	6.5	8.1	9.6	11.2
K=4	<b>A=</b>	1.0	1.3	1.5	1.9	2.2	2.5	4.0	5.5	7.1	8.6	10.2
K=5	<b>A=</b>	1.0	1.2	1.5	1.8	2.1	2.5	3.0	4.5	6.1	7.6	9.2
K=6	<b>A=</b>	1.0	1.2	1.5	1.8	2.1	2.4	2.8	3.5	5.1	6.6	8.1

	T=	16	17	18	19	20	21	22	23	24	25	26
K=3	<b>L=</b>	0.0	0.0	0.0	0.0	0.1	0.5	0.9	1.3	1.7	2.1	2.5
K=4	<b>L=</b>	0.0	0.0	0.2	0.6	1.0	1.4	1.8	2.2	2.6	3.1	3.5
K=5	<b>L=</b>	0.3	0.7	1.1	1.5	1.9	2.3	2.8	3.2	3.6	4.0	4.4
K=6	<b>L=</b>	1.2	1.6	2.0	2.4	2.8	3.3	3.7	4.1	4.5	4.9	5.3

The above values are calculated on the assumption that the doors have square edges. They are reduced if the doors have radiussed edges.

### Key

- S = thickness of the cabinet side
- D = required door overlay
- T = max. door thickness
- K = drilling distance
- A\* = reveal
- L = gap between door and carcass
- H = height of the mounting plate

\* either for a single door on the edge of a case or a pair of doors on a common partition.

An appropriate molding of the door reduces the values of "A" and "L"

"C" value

For this application, please use the following formula to calculate the maximum thickness which can be opened without touching the cabinet side or adjacent door, always considering the table of "L-K-T" values

$$C = 22 + K + A$$

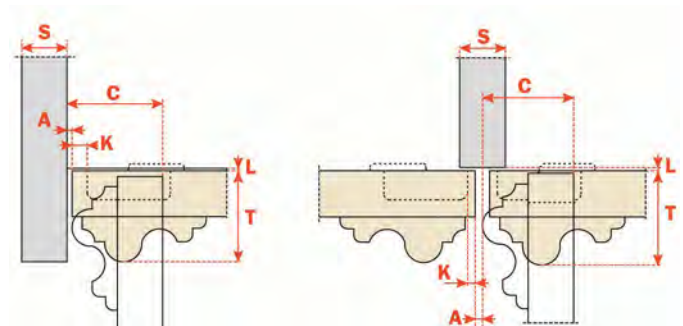



## SALICE 120° HINGE

### Full Overlay / "A" Crank

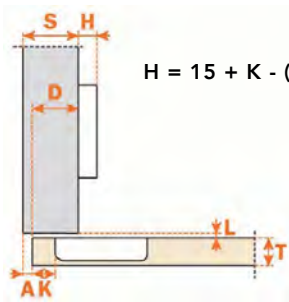

$$H = 15 + K - (D)$$

### 1/2" Overlay / "D" Crank

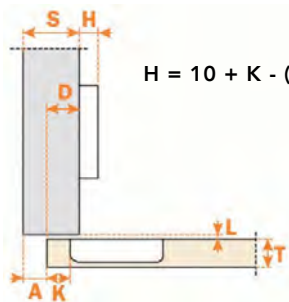

$$H = 10 + K - (D)$$

### Half Overlay / "G" Crank

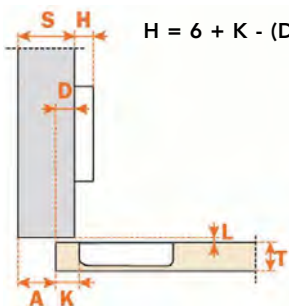

$$H = 6 + K - (D)$$

#### Key

- S = thickness of the cabinet side
- D = required door overlay
- T = max. door thickness
- K = drilling distance
- A\* = reveal
- L = gap between door and carcass
- H = height of the mounting plate

\* either for a single door on the edge of a case or a pair of doors on a common partition.

### SALICE 120° OPENING HINGE

- 35mm cup
- Clip-on or Slide-on depending on baseplate
- Easily mounts 3/4" thick doors

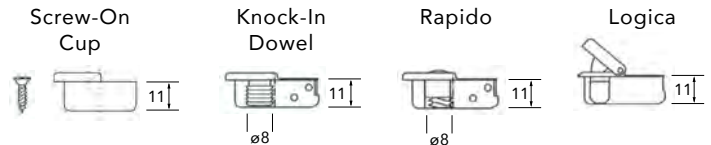

Pack: 300 ea.

Code	Description	List/ea
C2P9A99	Full Overlay, S/C, Screw-in	\$ 3.76
C2P8A99	Full Overlay, F/S, Screw-in	3.56
C2R9A99	Full Overlay, S/C, Dowel	3.27
C2R8A99	Full Overlay, F/S, Dowel	3.64
C2P9D99	1/2" Overlay, S/C, Screw-in	3.82
C2R9D99	1/2" Overlay, S/C, Dowel	4.07
C2P9G99	Half Overlay, S/C, Screw-in	3.69
C2P8G99	Half Overlay, F/S, Screw-in	3.03
C2R9G99	Half Overlay, S/C, Dowel	4.05
C2R8G99	Half Overlay, F/S, Dowel	3.41
C279A99	Rapido, Full Overlay, S/C	4.66
C278A99	Rapido, Full Overlay, F/S	4.12
C279D99	Rapido, 1/2" Overlay, S/C	3.94
C279G99	Rapido, Half Overlay, S/C	3.85
C2J9A99	Logica, Full Overlay, S/C	5.13
C2J9D99	Logica, 1/2" Overlay, S/C	4.12

F/S = Free Swinging

S/C = Self Closing

#### Screw-In

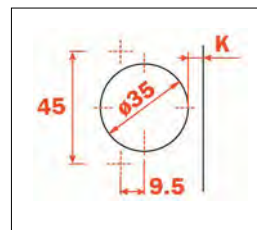

#### Knock-In Dowel, Rapido, Logica

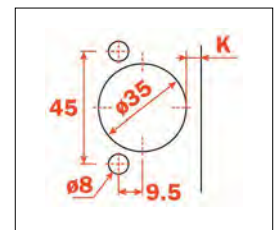

## SALICE 155° HINGE

### SALICE THICK DOOR HINGES - 155° Opening Series 200, Self-Closing



- For thick doors up to 32mm thick (1-1/4")
- Hinge with greater opening angle and reduced operating profile
- Zero protrusion on 'A' crank hinges
- 11mm deep metal cup, 155° opening
- Possible drilling distance (K): from 3 to 9mm
- Compatible with all traditional Series 200 mounting plates and with all DOMI® snap-on mounting plates

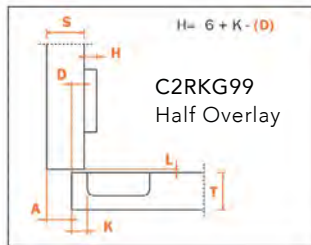
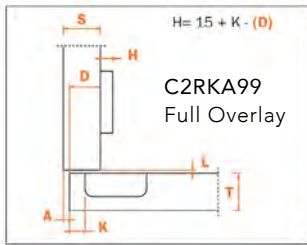

### Space needed to open the door

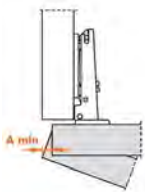

T=	26	27	28	29	30	31	32	33	34	35	
K=3	A=	0,0	0,0	0,0	0,8	3,0	4,8	7,1	11,7	16,4	20,7
K=4	A=	0,0	0,0	0,0	0,8	2,5	4,0	6,2	10,6	15,0	19,7
K=5	A=	0,0	0,0	0,0	0,8	2,0	3,4	4,8	9,8	14,1	18,4
K=6	A=	0,0	0,0	0,0	0,8	1,5	2,8	4,2	8,7	13,2	17,8
K=7	A=	0,0	0,0	0,0	0,8	1,4	2,3	3,0	7,8	12,0	16,7
K=8	A=	0,0	0,0	0,0	0,2	0,9	1,9	2,7	7,0	11,2	15,7
K=9	A=	0,0	0,0	0,0	0,2	0,7	1,5	2,1	5,9	10,4	15,0

The above values are calculated on the assumption that the doors have square edges. They are reduced if the doors have radiused edges.

### "C" Value

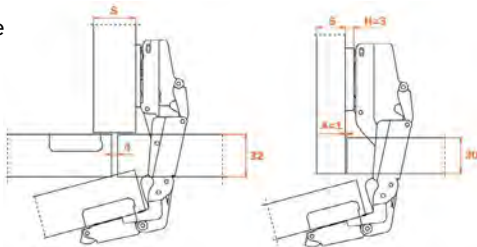

Pack: 100 each

Code	Description	List/ea
C2RKA99	Full Overlay, 155°, Dowel	\$ 11.12
C2PKA99	Full Overlay, 155°, Screw-in	10.25
C2RKG99	Half Overlay, 155°, Dowel	12.30

### SALICE THICK DOOR HINGES - For Large Overlays Series 200, Self-Closing, 155° Opening



- For Thick Doors up to 1-3/8" (36mm)
- Zero protrusion hinge and very small reveals for thick doors up to 1-3/16" (30mm)
- **Can achieve large overlays up to 1-1/2"**
- 110° opening with reduction clip S2BH37XG
- 11mm deep metal cup, 155° opening



**S2BH37XG**  
 Reduction clip for C2RHA99 hinges. Limits the opening to 110°.

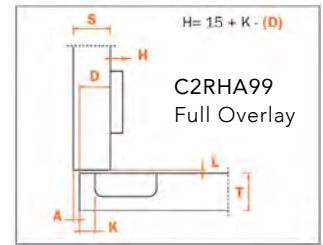

Pack: 100 each

Code	Description	List
C2RHA99	Full Overlay, 155°, Dowel	\$ 25.09/ea
S2BH37XG	155° to 110° Clip	41.45/C

## SOFT CLOSE

## SALICE 155° HINGE

### Silentia +

- **2 Pistons per cup** for smooth control on many sizes of doors

- **3 Speeds:** Selection Switch allows for slow, med & fast **soft** closing



+/- Speed Switch

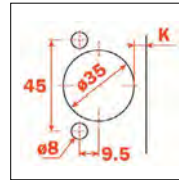

- Soft Close
- Wide Angle
- Zero protrusion

### SALICE SOFT-CLOSE 155° HINGES - Zero Protrusion

Silentia+ / Series 200

- Soft-Close hinge w/ Dowels
- For doors of 15mm min. thickness
- 13.5mm deep cup
- Zero protrusion on 'A' crank hinges
- Possible drilling distance (K): from 3 to 8mm
- Compatible with all traditional Series 200 mounting plates and with all DOMI® snap-on mounting plates.

Pack: 100 each

Code	Description	List/ea
C2RKA9	Full Overlay, 155°, Dowel	\$ 17.50
C2RKA6	" " ", Titanium finish	19.50
C27KA9	Full Overlay, 155°, Rapido	18.11
C2JKA9	Full Overlay, 155°, Logica	22.77
C2RKDE9	1/2" Overlay, 155°, Dowel	17.10
C2RKGE9	Half Overlay, 155°, Dowel	17.57
C2RKPE9	Inset, 155°, Dowel	19.07

Full Overlay / Arm 0

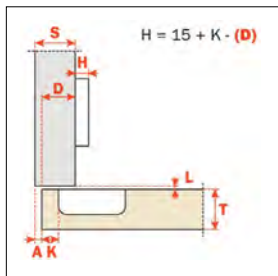

1/2" Overlay / Arm 5

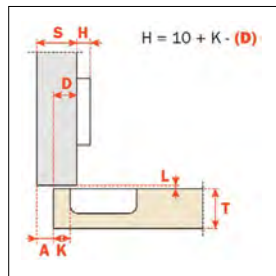

Half Overlay / Arm 9

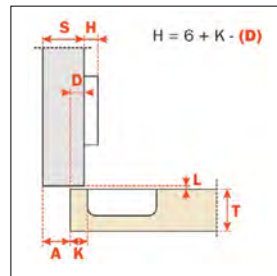

Inset / Arm 17

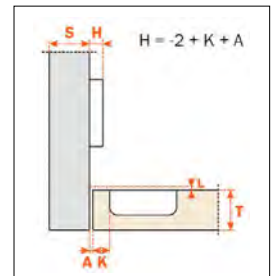

### Protrusion of the door

The door combined with a mounting plate H=0 and a straight arm hinge opens at 90° with lateral door protrusion of -6 mm.

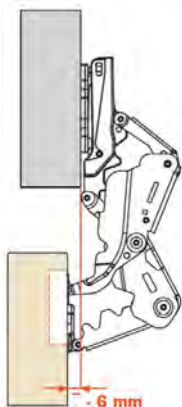

### 'C' Value

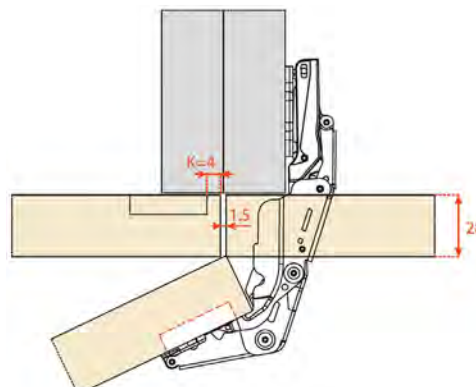

### Space Needed to Open the Door

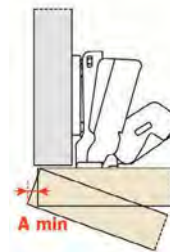

Values are calculated on the assumption that the doors have square edges. The are reduced if the doors have radiused edges.

T=	16	18	20	22
K=3	A= 0.0	0.0	0.3	1.2
K=4	A= 0.0	0.4	0.4	1.3
K=5	A= 0.0	0.1	0.5	1.6
K=6	A= 0.0	0.1	1.2	3.0
K=7	A= 0.0	0.1	0.7	2.5
K=8	A= 0.0	0.1	0.6	1.9

## SALICE 165° HINGE

### SALICE 165° HINGE

Series 200

A wide angle hinge that takes thick doors and allows a variety of special applications. 11mm deep die-cast cup. Max. door thickness: 28mm. Zero protrusion. Possible drilling distance on the door (K): 3 to 8mm. Compatible with all slide-on and clip-on mounting plates. Optional clips reduces open angle to 125° or 110° for special applications.

#### Features:

- Automatic Door Adjustment
- Constant gap between cabinet and front during overlay adjustment of doors (exclusive to Salice)
- Available with smooth cam-drive adjustments for height and depth (exclusive to Salice)
- ANSI, BHMA rated; ISO 9001. WI approved.



How much space does a door need to open?

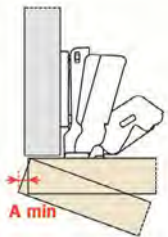

T=	16	18	20	22	24	26	28
K=3	A= 0.0	0.0	0.0	0.7	2.7	4.6	7.9
K=4	A= 0.0	0.0	0.0	0.1	1.8	3.8	6.9
K=5	A= 0.0	0.0	0.0	0.1	1.2	3.0	5.9
K=6	A= 0.0	0.0	0.0	0.1	0.9	2.5	4.9
K=7	A= 0.0	0.0	0.0	0.1	0.7	2.0	3.9
K=8	A= 0.0	0.0	0.0	0.1	0.6	1.7	3.2

The above values are calculated on the assumption that the doors have square edges. They are reduced if the doors have radlussed edges.

#### Key

- S = thickness of the cabinet side
- D = required door overlay
- T = max. door thickness
- K = drilling distance
- A\* = reveal
- L = gap between door and carcass
- H = height of the mounting plate

\* either for a single door on the edge of a case or a pair of doors on a common partition.

An appropriate molding of the door reduces the values of "A" and "L"

"C" value

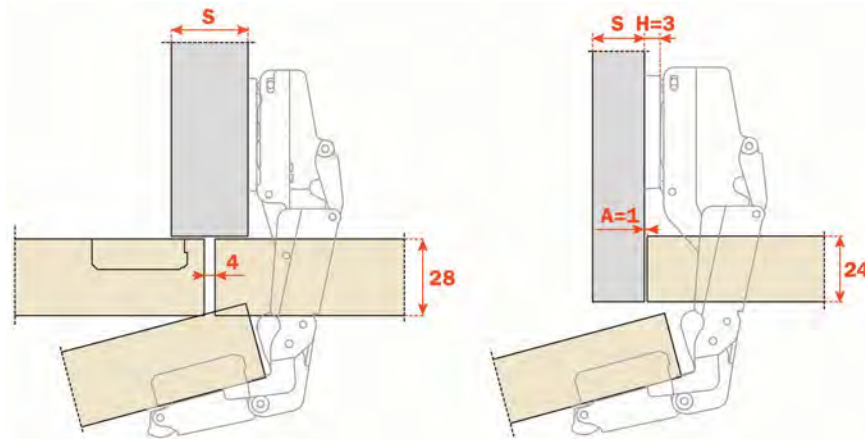

For spaces with removable components:

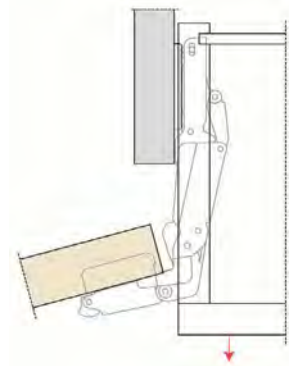

Opening with lateral door protrusion equal to 5.5mm with a hinge with straight arm, H=0mm mounting plates and K=3mm



## SALICE 165° HINGE

### Full Overlay / "A" Crank

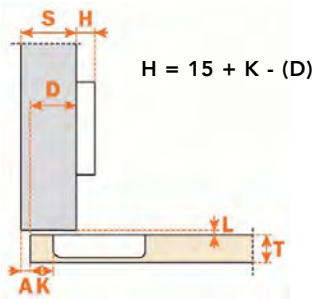

### 1/2" Overlay / "D" Crank

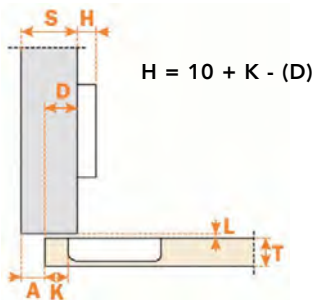

### Half Overlay / "G" Crank

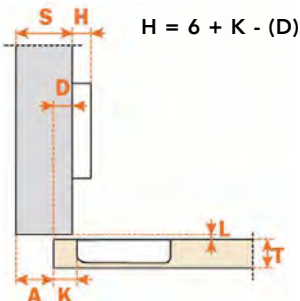

### Inset / "P" Crank

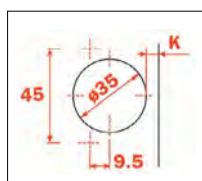
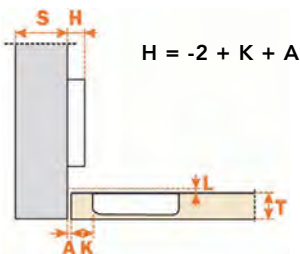

Screw-In

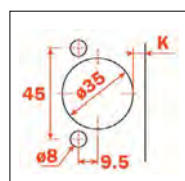

Knock-In Dowel, Rapido, Logica

### SALICE 165° OPENING HINGE

- Hinge with greater opening angle and reduced operating profile
- 35mm cup dia, 11mm deep
- Clip-on or Slide-on depending on baseplate
- F/O, S/C with Dowels available in Titanium finish

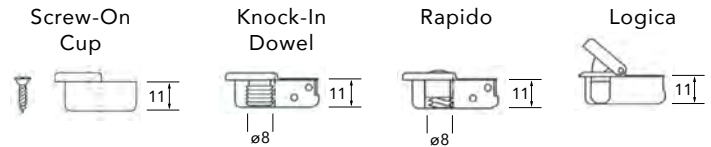

Pack: 100 ea.

Code	Description	List/ea
C2PFA99	Full Overlay, S/C, Screw-in	\$ 7.69
C2RFA99	Full Overlay, S/C, Dowel	7.82
C2RFA66	Titanium, F/O, S/C, Dowel	7.75
C2REA99	Full Overlay, F/S, Dowel	7.87
C2RFD99	1/2" Overlay, S/C, Dowel	8.74
C2PFG99	Half Overlay, S/C, Screw-in	7.99
C2PEG99	Half Overlay, F/S, Screw-in	7.91
C2RFG99	Half Overlay, Self-Cl, Dowel	8.61
C2REG99	Half Overlay, F/S, Dowel	7.51
C2PFP99	Inset, S/C, Screw-in	11.16
C2PEP99	Inset, F/S, Screw-in	11.14
C2RFP99	Inset, S/C, Dowel	10.33
C2REP99	Inset, F/S Dowel	10.82
C27FA99	Rapido, Full Overlay, S/C	9.05
C27FD99	Rapido, 1/2" Overlay, S/C	8.49
C27FG99	Rapido, Half Overlay, S/C	8.84
C27FP99	Rapido, Inset, S/C	11.32
C2JFA99	Logica, Full Overlay, S/C	9.91
C2JFD99	Logica, 1/2" Overlay, S/C	10.37
C2JFG99	Logica, Half Overlay, S/C	9.80
C2JFP99	Logica, Inset, S/C	12.54

F/S = Free Swinging      S/C = Self Closing

### Hinge Reduction Clips

Code	Description	List/C
S2AF37X3	Reduction Clip (to 125°)	\$ 33.06
S2BF37XY	Reduction Clip (to 110°)	69.05

## LOGICA

## SALICE

### "TOOL FREE" HINGE

Salice Logica

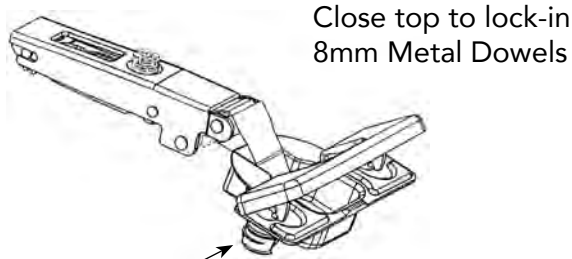

Tool-Free Dowels

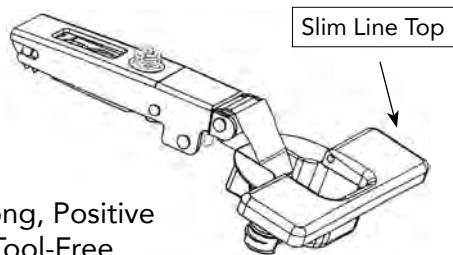

Strong, Positive  
Tool-Free

Uses Standard 45mm Salice bore pattern

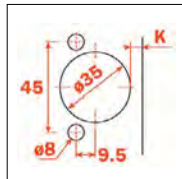
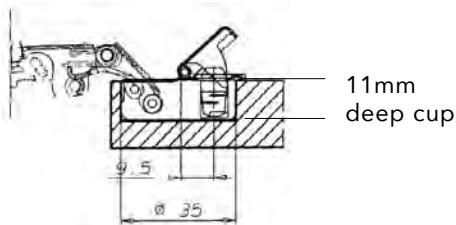

Self-Closing Logica Hinges. Fits Salice/Blum bore pattern.  
Fits all Salice Plates.

Code	Description	Ctn	List/ea
C2J6A99	110°, Full Overlay	300	\$ 4.83
C2J6D99	110°, 1/2" Overlay	300	4.42
C2J6G99	110°, Half Overlay	300	4.24
C2J9A99	120°, Full Overlay	300	5.13
C2J9D99	120°, 1/2" Overlay	300	4.12
C2JFA99	165°, Full Overlay	100	9.91
C2JBN99AC	Blind Corner Hinge	150	6.02
C2JBM99AC	Positive 45° Hinge	150	6.70

### 105° SILENTIA+ SOFT CLOSE LOGICA

Series 100



Pack: 300 each

Code	Description	List/ea
C1J6AE9	Full Overlay, 105°, Soft Close	\$ 5.08
C1J6DE9	1/2" Overlay, 105°, Soft Close	5.16
C1J6GE9	Half Overlay, 105°, Soft Close	5.25
C1J6PE9	Inset, 105°, Soft Close	5.37

### 110° SILENTIA+ SOFT CLOSE LOGICA

Series 700



Pack: 300 each

Code	Description	List/ea
C7J6AE9	Full Overlay, 110°, Soft Close	\$ 7.37
C7J6DE9	1/2" Overlay, 110°, Soft Close	7.23
C7J6GE9	Half Overlay, 110°, Soft Close	7.68
C7J6PE9	Inset, 110°, Soft Close	7.91

## SALICE

## RAPIDO - RAPID MOUNT & REMOVAL

### THE SALICE RAPIDO SYSTEM

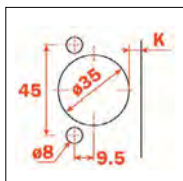

Standard Door Drilling  
 Salice/Blum Pattern

Rotate the cam 180° clockwise until the pointed part of the cam covers the orange dot. The steel teeth of the cam are now fixed to the inner walls of the hole. To remove hinge, simply rotate the cam 180° counter-clockwise. Close hinge and pull gently away from door.

The Salice "Rapido" features standard door drilling. Time saving and cost effective: the hinge is fixed directly to the door, no adapter or machine insertion is required. Dowels are permanently fixed to the hinge. No components remain in the door after removal.

Note: A hand-held screwdriver is the only tool needed (a power screwdriver is not recommended).

#### Fixing

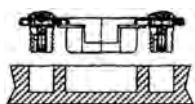

Hinge is easily inserted by hand

#### Insertion

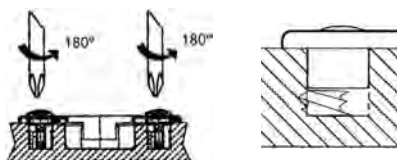

### RAPIDO - RAPID MOUNT & REMOVAL

Code	Description	Ctn	List/ea
C27BP99	94° Inset, S/C	300 ea.	\$ 3.71
C27BA99	94° Full Overlay, S/C	300	3.77
C276A99	110° Full Overlay, S/C	300	3.95
C274A99	110° Full Overlay, F/S	300	3.59
C276D99	110° 1/2" Overlay, S/C	300	3.32
C276G99	110° Half Overlay, S/C	300	3.43
C276P99	110° Inset, S/C	300	4.11
C279A99	120° Full Overlay, S/C	300	4.66
C278A99	120° Full Overlay, F/S	300	4.12
C279D99	120° 1/2" Overlay, S/C	300	3.94
C279G99	120° Half Overlay, S/C	300	3.85
C27FA99	165° Full Overlay, S/C	100	9.05
C27FD99	165° 1/2" Overlay, S/C	100	8.49
C27FG99	165° Half Overlay, S/C	100	8.84
C27FP99	165° Inset, S/C	100	11.32
C27YA99	Pie Cut Corner Hinge	150	8.46
C27BM99AC	45° Hinge	150	6.63
C27BN99AC	Blind Corner	150	6.46
C27BH99	-45° Angle, S/C	150	6.42

F/S = Free Swinging  
 S/C = Self Closing

#### 105° SILENTIA+ SOFT CLOSE RAPIDO

Series 100



100 Series drills at  
 12mm depth

Pack: 300 each

Code	Description	List/ea
C176AE9	Full Overlay, 105°, Soft Close	\$ 4.58
C176DE9	1/2" Overlay, 105°, Soft Close	4.71
C176GE9	Half Overlay, 105°, Soft Close	5.10
C176PE9	Inset, 105°, Soft Close	4.88

#### 110° SILENTIA+ SOFT CLOSE RAPIDO

Series 700



700 Series drills at  
 13.5mm depth

Pack: 300 each

Code	Description	List/ea
C776AE9	Full Overlay, 110°, Soft Close	\$ 6.11
C776DE9	1/2" Overlay, 110°, Soft Close	6.37
C776GE9	Half Overlay, 110°, Soft Close	6.59
C776PE9	Inset, 110°, Soft Close	6.62



# SALICE THICK DOOR HINGE - F SERIES

## SALICE THICK DOOR HINGE - F SERIES - 40mm Cup

A special application hinge for profile and thick doors up to 1.57" (40mm). 13mm deep die-cast cup. 40mm cup dia. 94° opening. Compatible with clip-on and slide-on baseplates. Possible Boring Distance on the door (K): from 3 to 15mm.

### Features:

- Automatic Door Adjustments
- Constant gap between cabinets and front during overlay adjustment of doors (exclusive to Salice)
- Available with smooth cam-drive adjustments for height and depth (exclusive to Salice)
- ANSI, BHMA rated; ISO 9001. WI approved.



How much space does a door need to open?

	T=	20	21	22	23	24	25	26	27	28	29	30	31	32	33	34	35	36	37	38	39	40	L=
K=3	A=	0.4	0.5	0.7	0.8	1.0	1.2	1.4	1.6	1.9	2.2	2.5	2.8	3.1	3.5	4.1	5.0	6.0	6.9	7.8	8.8	9.7	0.0
K=4	A=	0.4	0.5	0.7	0.8	1.0	1.2	1.4	1.6	1.9	2.1	2.4	2.7	3.0	3.4	3.8	4.4	5.3	6.3	7.2	8.1	9.0	0.0
K=5	A=	0.4	0.5	0.6	0.8	1.0	1.2	1.4	1.6	1.8	2.1	2.4	2.7	3.0	3.3	3.7	4.1	4.8	5.7	6.6	7.5	8.4	0.0
K=6	A=	0.4	0.5	0.6	0.8	0.9	1.1	1.3	1.6	1.8	2.1	2.3	2.6	2.9	3.3	3.6	4.0	4.4	5.2	6.0	6.9	7.8	0.0
K=7	A=	0.4	0.5	0.6	0.8	0.9	1.1	1.3	1.5	1.8	2.0	2.3	2.6	2.9	3.2	3.6	3.9	4.3	4.8	5.5	6.4	7.3	0.0
K=8	A=	0.4	0.5	0.6	0.8	0.9	1.1	1.3	1.5	1.7	2.0	2.2	2.5	2.8	3.1	3.5	3.8	4.2	4.7	5.1	5.9	6.8	0.0
K=9	A=	0.4	0.5	0.6	0.7	0.9	1.1	1.3	1.5	1.7	2.0	2.2	2.5	2.8	3.1	3.4	3.8	4.2	4.6	5.0	5.5	6.3	0.0
K=10	A=	0.3	0.5	0.6	0.7	0.9	1.1	1.3	1.5	1.7	1.9	2.2	2.4	2.7	3.0	3.4	3.7	4.1	4.5	4.9	5.4	6.0	0.0
K=11	A=	0.3	0.4	0.6	0.7	0.9	1.0	1.2	1.4	1.7	1.9	2.1	2.4	2.7	3.0	3.3	3.6	4.0	4.4	4.8	5.2	5.7	0.0
K=12	A=	0.3	0.4	0.6	0.7	0.9	1.0	1.2	1.4	1.6	1.9	2.1	2.4	2.6	2.9	3.3	3.6	3.9	4.3	4.7	5.1	5.6	0.4
K=13	A=	0.3	0.4	0.5	0.7	0.9	1.0	1.2	1.4	1.6	1.8	2.1	2.3	2.6	2.9	3.2	3.5	3.8	4.2	4.5	4.9	5.4	1.2
K=14	A=	0.3	0.4	0.5	0.7	0.8	1.0	1.2	1.4	1.6	1.8	2.0	2.3	2.6	2.8	3.2	3.5	3.8	4.2	4.5	4.9	5.4	2.2
K=15	A=	0.3	0.4	0.5	0.7	0.8	1.0	1.2	1.4	1.6	1.8	2.0	2.3	2.6	2.8	3.2	3.5	3.8	4.2	4.5	4.9	5.4	3.2

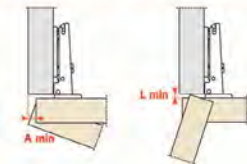

The above values are calculated on the assumption that the doors have square edges. They are reduced if the doors have radiussed edges.

"C" value

For this application, please use the following formula to calculate the maximum thickness which can be opened without touching the cabinet side or adjacent door, always considering the table of "L-K-T" values

$$C = 28.5 + K + A$$

$$C = 28.5 + K + A$$

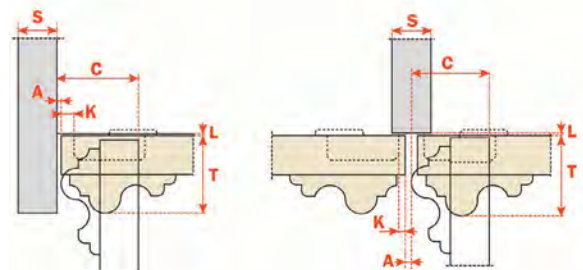

## SALICE THICK DOOR HINGE - F SERIES

### Arm 0 / Full Overlay



$$H = 19 + K - (D)$$

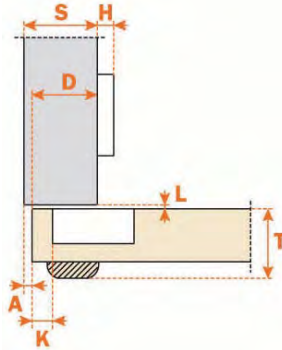

### Arm 11 / Half Overlay



$$H = 8 + K - (D)$$

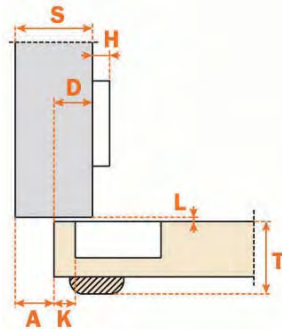

### Arm 22 / Inset



$$H = -3 + K + A$$

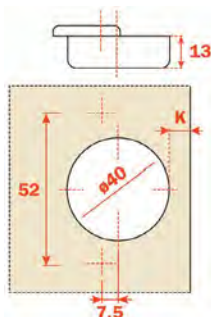
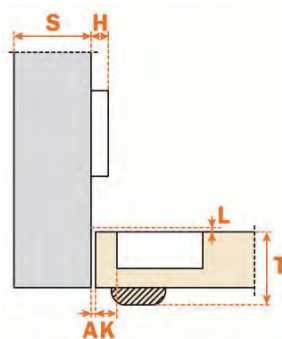

### SALICE THICK DOOR HINGE "F" SERIES

This series has been designed to solve unusual application problems. For example, heavy thick doors (inset up to 40mm) or overlays up to 34mm. Also, the hinge of choice for pocket door applications. Some overlays available in a Titanium finish.

- 94° Opening
- For thick doors up to 1-1/2"
- For Overlays up to 1-1/4"
- Clip-on or slide-on depending on baseplate used
- Screw-in hinges unless noted

Pack: 300 each

Code	Description	List/ea
CFA7A99	Full Overlay, S/C	\$ 6.34
CFA5A99	Full Overlay, F/S	5.24
CFA7G99	Half Overlay, S/C	6.44
CFA7G66	Half Overlay, S/C, Titanium	7.16
CFA5G99	Half Overlay, F/S	5.89
CFA7P99	Inset, S/C	6.53
CFA7P66	Inset, S/C, Titanium	6.53
CFA5P99	Inset, F/S	6.96
CFB7P99*	Inset, S/C, w/ Dowel	3.95

\* disc when out

F/S = Free Swinging  
 S/C = Self Closing

#### Key

- S = thickness of the cabinet side
- D = required door overlay
- T = max. door thickness
- K = drilling distance
- A\* = reveal
- L = gap between door and carcass
- H = height of the mounting plate

\* either for a single door on the edge of a case or a pair of doors on a common partition.



# SALICE THICK DOOR HINGE "F" SERIES ASSEMBLY EXAMPLES

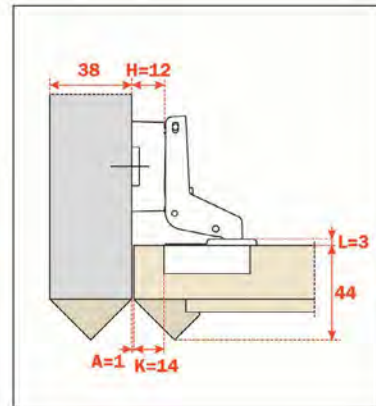
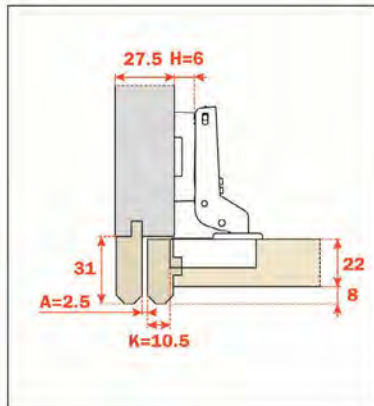
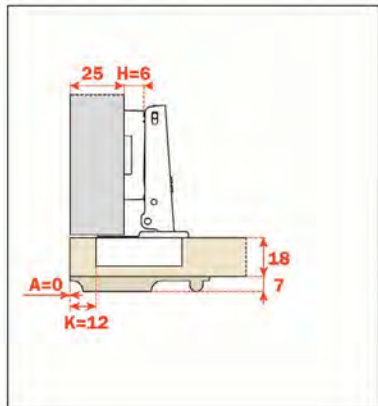
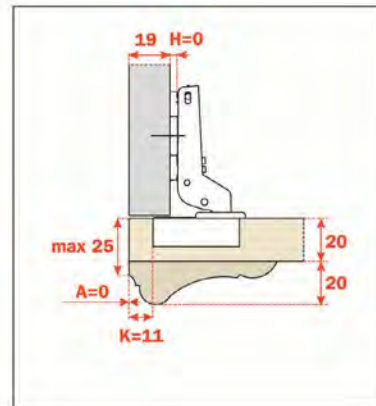
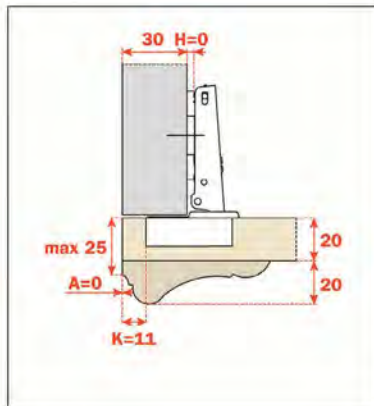
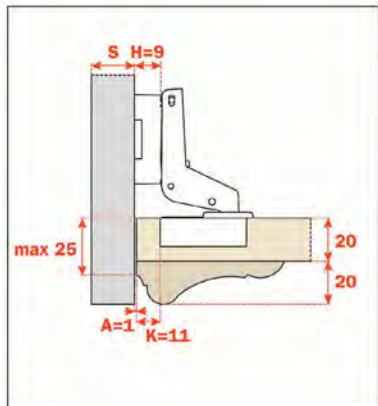
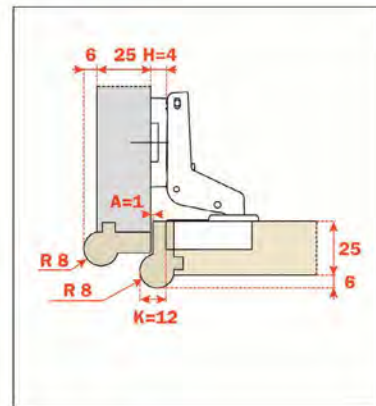
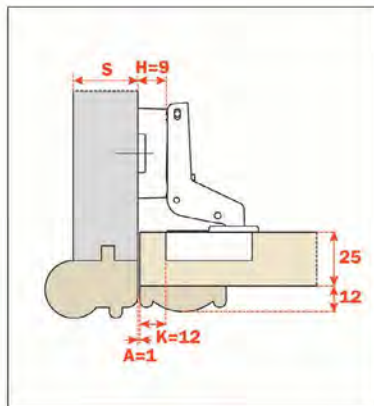
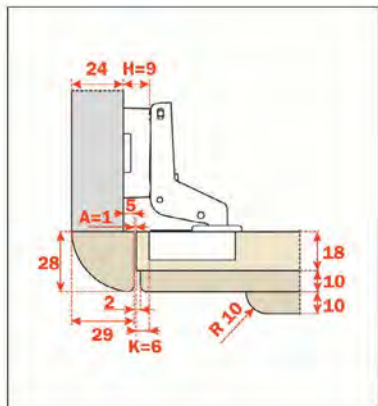
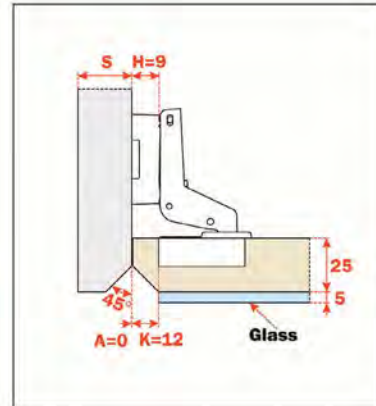
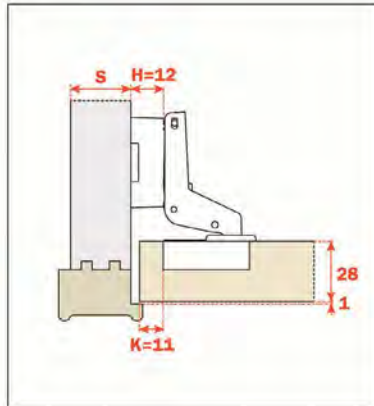
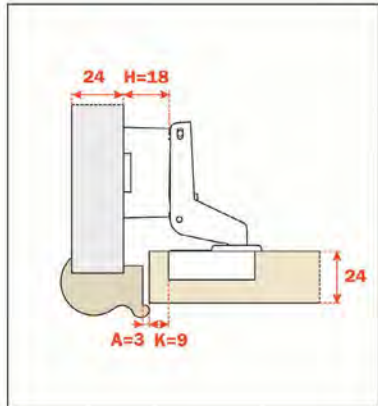

7



# SALICE THICK DOOR HINGE "F" SERIES ASSEMBLY EXAMPLES

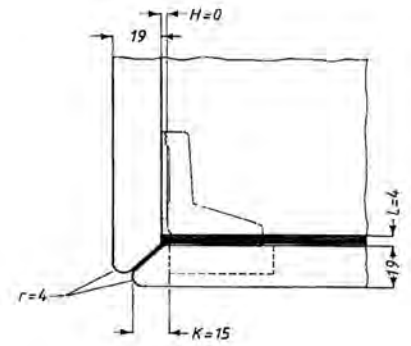
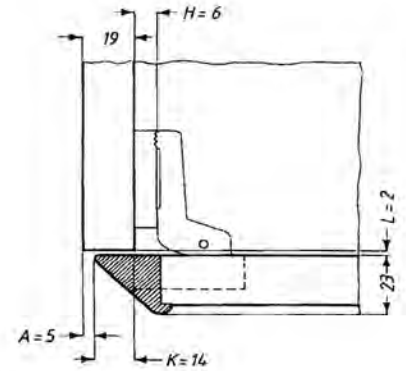
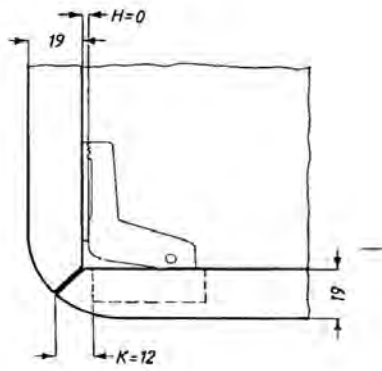
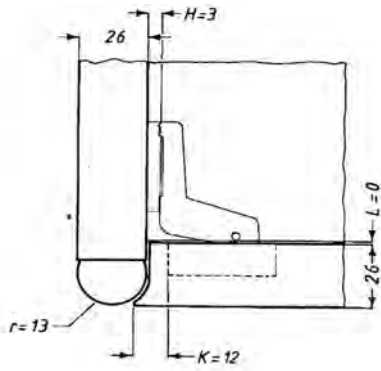

Flipper

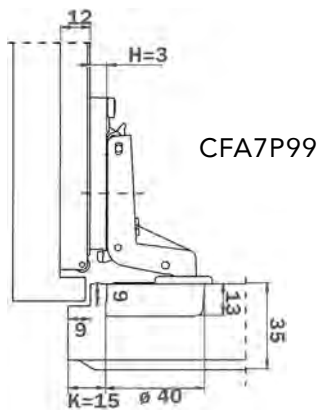

Flipper

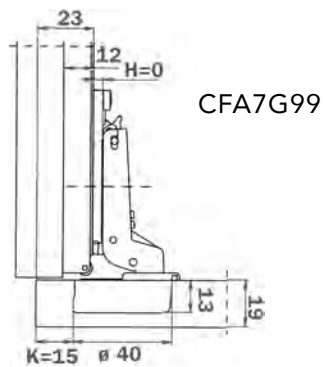

Flipper

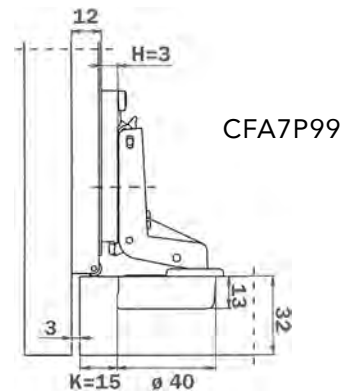

7



## SALICE SPECIAL ANGLED ASSEMBLIES

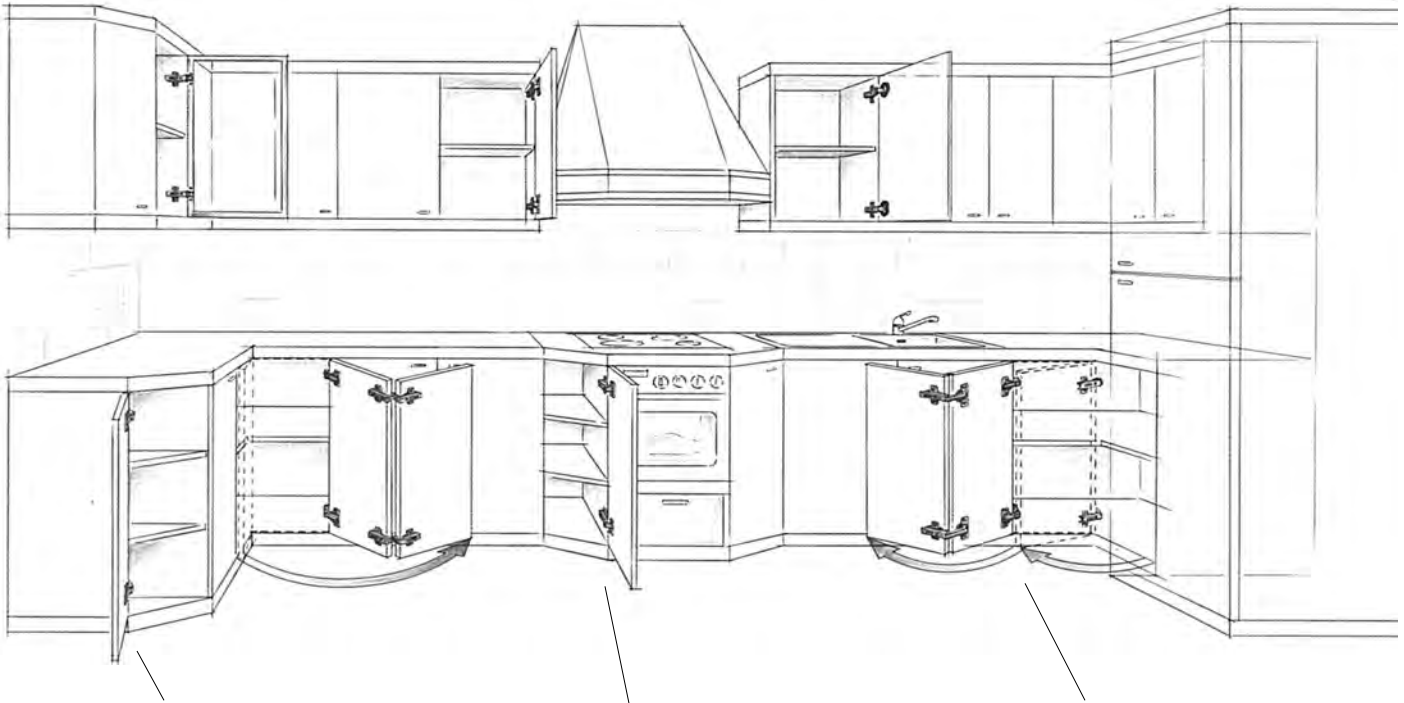

7

Hinges for positive angles between 0° and +70°

Hinges for negative angles between 0° and -45°

Hinges for cross-corner cabinets

Salice angled hinges and mounting plates, adjustable variable angled mounting plates enable any angle from -45° to +70° to be constructed.

For more information, go to:  
[macmurraypacific.com/salice/html/index.html](http://macmurraypacific.com/salice/html/index.html)

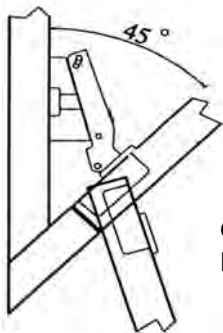

**C2PBW99  
B2V3BW9/15**

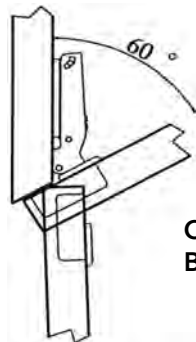

**C2PBW99  
BAR3R09**

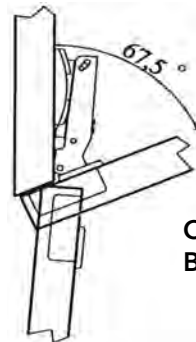

**C2PBW99  
B2V3BW9R/15**





## SALICE SPECIAL ANGLE ASSEMBLY EXAMPLES

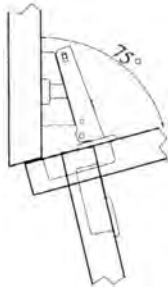

**C2PBA99**  
**B2V3BW9/15**



**C2PBA99**  
**B2V3BW9R/15**

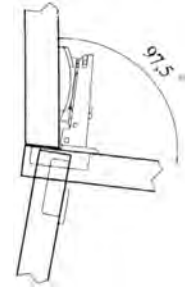

**C2PBA99**  
**B2V3BW9R/15**

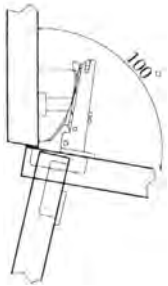

**C2PBA99**  
**B2V3BW9S/15**

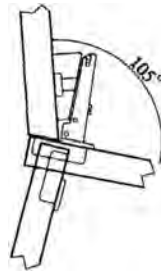

**C2PBA99**  
**B2V3BW9/15**

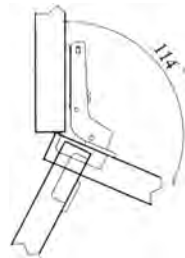

**C2RBU99**  
**B2R3E09/15**

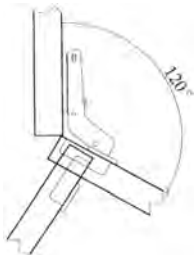

**C2RBE99**  
**B2R3E09/15**

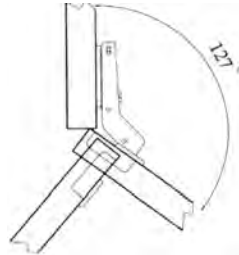

**C2RBK99**  
**B2R3E09/15**

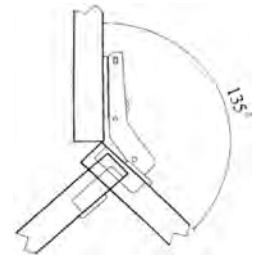

**C2PBM99**  
**B2R3E09/15**

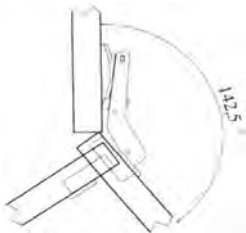

**C2PBM99**  
**B2V3BW9R/15**

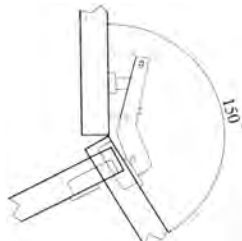

**C2PBM99**  
**B2V3BW9/15**

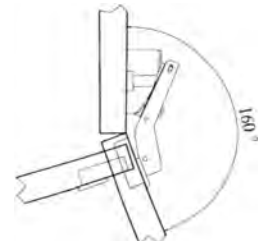

**C2PBM99**  
**B2V3BW9S/15**

## SALICE PIE-CUT HINGES

### SALICE HINGES FOR PIE-CUT LAZY SUSANS

Series 200 / For Corner Cabinets

Special hinge uses standard bore pattern at standard 4mm distance from edge of the door. Simple and easy, saves on mis-bored doors. 11mm deep die-cast cup. Opening angle of the first door: 70°. Self-closing. Max. thickness of door with square edges: 23mm. Boring distance (K) = 4mm (fixed). (For thicker doors, or radius edges, call factory for technical assistance.) Compatible with all screw-on and clip-on mounting plates.



#### Features:

- Automatic Door Adjustment
- Constant gap between cabinet and front during overlay adjustment of doors (exclusive to Salice)
- Available with smooth cam-drive adjustments for height and depth (exclusive to Salice)
- ANSI, BHMA rated; ISO 9001. WIC approved.

**C2AYA99 hinge movement and maximum opening width**

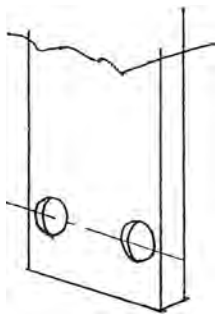

**Common Tab**  
 Both Sides of Door

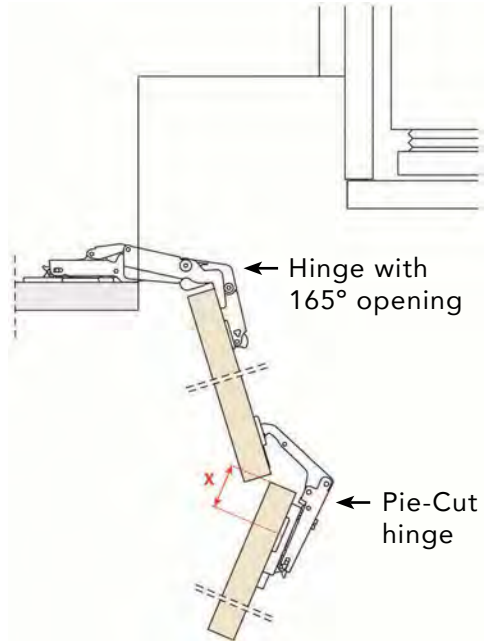
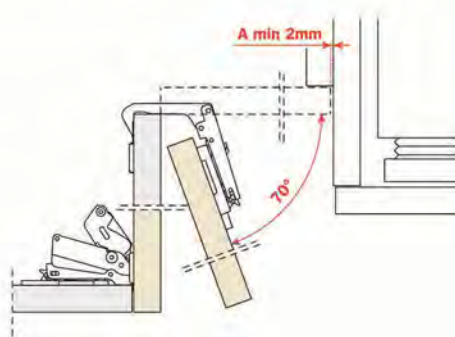

Use these formulas to determine the height of mounting plate and drilling distance

**Drilling distance:**  
 cruciform mounting plates =  $47 - T$

**Drilling distance:**  
 longitudinal mounting plates =  $(31 - T) + 32$

**$H^* = 26 - T - K$**   
 The mounting plate heights that are not standard are obtained with the mounting plate of lower height + sideways adjustment

**T = Thickness of the door with square edges**

**H = Height of the mounting plate**

The drilling distance of the mounting plate (X) varies according to the thickness of the doors.

#### Examples with doors with square edges

T	K	X	X	H
20	5	$47 - 20 = 27 \text{ mm}$	$31 - 20 = 11 + 32 \text{ mm}$	$26 - 20 - 5 = 1 \text{ mm}$
16	6	$47 - 16 = 31 \text{ mm}$	$31 - 16 = 15 + 32 \text{ mm}$	$26 - 16 - 6 = 4 \text{ mm}$
19	3	$47 - 19 = 28 \text{ mm}$	$31 - 19 = 12 + 32 \text{ mm}$	$26 - 19 - 3 = 4 \text{ mm}$
18	4	$47 - 18 = 29 \text{ mm}$	$31 - 18 = 13 + 32 \text{ mm}$	$26 - 18 - 4 = 5$ (H = 4 + 1 mm adjustment)



## SALICE PIE-CUT HINGES

Screw-In

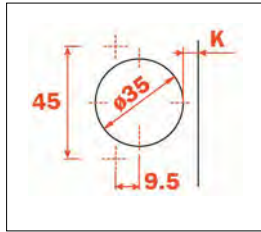

### SALICE PIE-CUT CORNER HINGES cont.

- 11mm deep cup
- 35mm cup diameter
- Opening angle of the first door 70°
- Possible drilling distance on the door (K) : from 3 to 6 mm

Knock-In Dowel,  
Rapido, Logica

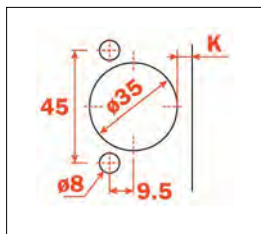

Knock-In  
Dowel

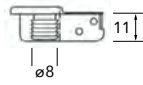

Rapido

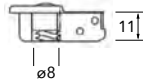

Pack: 100 each

Code	Description	List/ea
C2PYA99	Angled hinge, Screw-in	\$ 7.80
C2RYA99	Angled hinge, Dowel	9.05
C2RYA66	Titanium, Dowel	10.80
C27YA99	Angled hinge, Rapido	8.46

K = boring distance

Pie Corner hinge installation: Selecting & positioning the mounting plate			
If Door thickness is: (T)	Use mounting plate height (H)	Mounting plate location Door edge to screw center (B)	Hinge cup edge bore distance (K)
16 mm (5/8")	6 mm	31 mm (1-1/4")	4 mm
19 mm (3/4")	2 mm or 3 mm	28 mm (1-1/8")	4 mm
22 mm (7/8")	0 mm	25 mm (1")	4mm

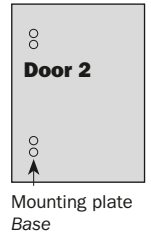
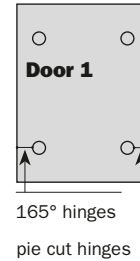

## POSITIVE ANGLE HINGES

## SALICE

### SALICE POSITIVE ANGLE HINGES - Self Closing

94° Opening. 11mm deep metal cup. Possible Boring Distance on the door (K): from 3 to 9mm. Compatible with all Clip-on and Slide-on mounting plates.

- Automatic Door Adjustment
- Constant gap between cabinet and front during overlay adjustment of doors (exclusive to Salice)
- Available with smooth cam-drive adjustments for height and depth (exclusive to Salice)
- ANSI, BHMA rated; ISO 9001. WIC approved.

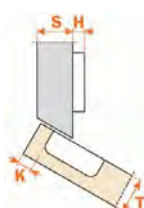
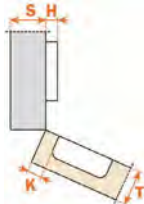
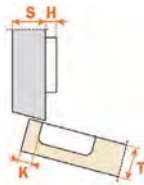

### POSITIVE ANGLE HINGES Cont.

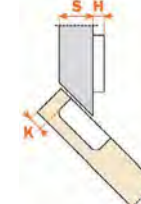
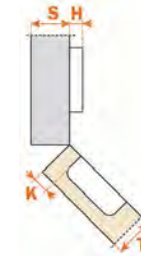
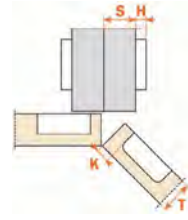
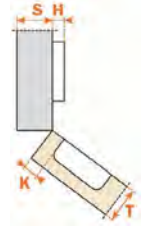

Code	Description	Ctn	List/ea
C2RBZ99	+15° S/C, Dowel	150 ea.	\$ 5.07
C2RBU99	+24° S/C, Dowel	150	5.98
C2RBE99	+30° S/C, Dowel	150	5.86
C2RBT99	+30° S/C, Dowel	150	6.62

S/C = Self Closing

Code	Description	Ctn	List/ea
C2RBK99	+37° S/C, Dowel	150 ea.	\$ 5.45
C2PBM99AC	+45° S/C, Screw-in	150	5.15
C2RBM99AC	+45° S/C, Dowel	150	6.17
C2PBM99	+45° S/C, Screw-in	150	5.93
C2RBM99	+45° S/C, Dowel	150	5.86
C2RBV99	+45° S/C, Dowel	150	6.08

S/C = Self Closing

## SALICE

## NEGATIVE ANGLE HINGES

### SALICE NEGATIVE ANGLE HINGES - Self Closing

94° Opening. 11mm deep metal cup. Possible Boring Distance on the door (K): from 3 to 9mm. Compatible with all Clip-on and Slide-on mounting plates.

C2PBW99  
 C2RBW99  
 -30°

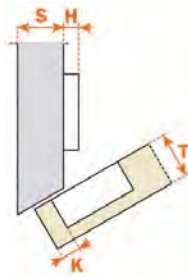

C2PBH99  
 C2RBH99  
 -45°

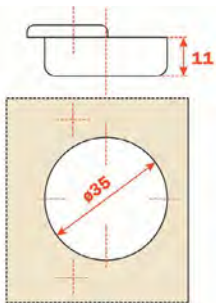
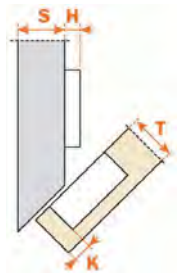

S = thickness of cab. side  
 H = height of mounting plate  
 K = boring distance  
 T = max. door thickness

**For Soft Close  
 Angle Hinges,  
 see next page**

7

Code	Description	Ctn	List/ea
C2PBW99	-30° S/C, Screw-in	150 ea.	\$ 5.41
C2RBW99	-30° S/C, Dowel	150	6.01
C2RBH99	-45° S/C, Dowel	150	6.26
C27BH99	-45° S/C, Rapido	150	6.42

S/C = Self Closing



## SOFT-CLOSE SPECIALTY HINGES

## SALICE

### SOFT-CLOSE SPECIALTY HINGES - 105°

Silentia+ / Series 100

- 105° opening
- 12mm deep cup
- Possible drilling distance on the door (K): from 3 to 6mm
- Soft Close action is concealed within the hinge cup

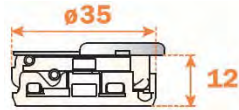

100 Series drills at 12mm depth

### Positive Angle: 45° AC

C1R6ME9AC / Dowel



### Positive Angle: 45°

C1R6ME9 / Dowel  
C176ME9 / Rapido



### Blind Corner

C1R6NE9AC / Dowel  
C176NE9AC / Rapido

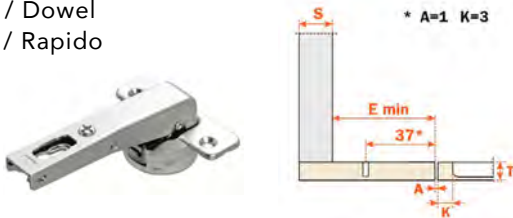

Pack: 150 ea.

Code	Description	List/ea
C1R6ME9AC	45° AC, Dowel	\$ 11.13
C1R6ME9	45° Corner, Dowel	11.53
C176ME9	45° Corner, Rapido	11.03
C1R6NE9AC	Blind Corner, Dowel, 110°	11.12
C176NE9AC	Blind Corner, Rapido, 110°	11.74

### SOFT-CLOSE SPECIALTY HINGES - 110°

Silentia+ / Series 700

- 110° opening
- 13.5mm deep cup
- Soft Close action is concealed within the hinge cup

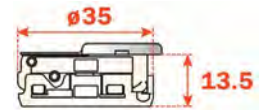

13.5mm cup depth.  
Min 16mm Door,  
Tight gaps

### Positive Angle: 45° AC

C7R6ME9AC / Dowel



### Positive Angle: 45°

C7R6VE9 / Dowel



### Negative Angle: -30°

C7R6WE9 / Dowel



### Blind Corner Inset

C7R6NE9AC / Dowel



### Blind Corner Overlay

C7R6NE9AM / Dowel



Pack: 150 ea.

Code	Description	List/ea
C7R6ME9AC	45° AC, Dowel	\$ 10.52
C7R6VE9	45° Corner, Dowel	10.13
C7R6WE9	-30° Corner, Dowel	10.13
C7R6NE9AC	Blind Corner Inset, Dowel	10.88
C7R6NE9AM	Blind Corner Overlay, Dowel	10.53

# SALICE

# BLIND CORNER HINGES

## BLIND CORNER INSET HINGE FOR CABINET SIDES

With 37x32mm Standard Drilling

94° opening. 11mm deep metal cup. Possible drilling distance on the door (K): from 3 to 8mm. Compatible with all slide-on and clip-on mounting plates.

Features:

- Automatic Door Adjustment
- Constant gap between cabinet and front during overlay adjustment of doors (exclusive to Salice)
- Available with smooth cam-drive adjustments for height and depth (exclusive to Salice)
- ANSI, BHMA rated; ISO 9001. WI approved.



C2RBN99AC  
 C27BN99AC  
 C2RAN99AC

For Clip-on Plates:  
 E = 70mm

For Slide-on Plates:  
 E = 61mm

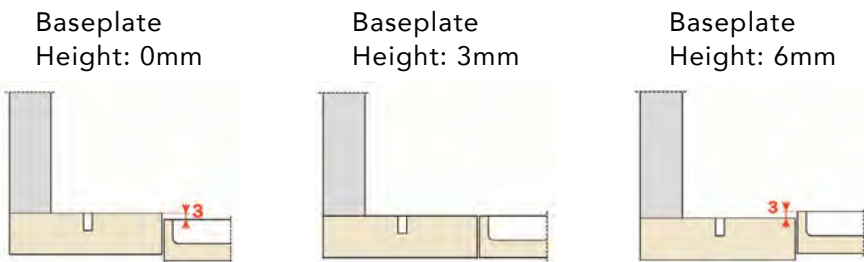
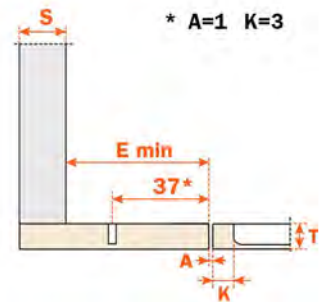

Key

S = thickness of the cabinet side  
 T = max. door thickness  
 K = drilling distance  
 H = height of the mounting plate

Code	Description	Ctn	List/ea
C2RBN99AC	S/C, Dowel	150 ea.	\$ 5.87
C2RAN99AC	F/S, Dowel	150	5.93
C27BN99AC	S/C, Rapido	150	6.46

Screw-In



Knock-In Dowel, Rapido

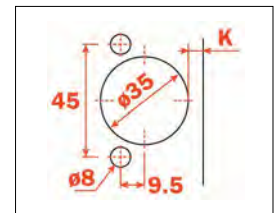
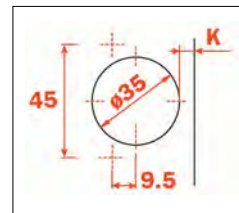
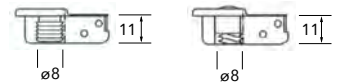

S/C = Self Closing  
 F/S = Free Swinging

## SOFT-CLOSE INSET BLIND CORNER HINGE

Silentia+, 700 Series, 110° opening



700 Series drills at 13.5 (17/32") depth

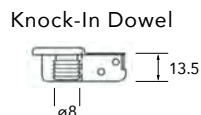
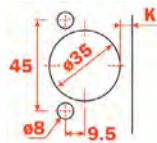

Code	Description	Ctn	List/ea
C7R6NE9AC	110° Soft-Close, Inset B/C, Dowel	150 ea.	\$ 10.88

## SOFT-CLOSE INSET BLIND CORNER HINGE

Silentia+, 200 Series, 94° opening - Thick Door



Drills at 15.5mm depth

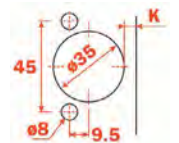
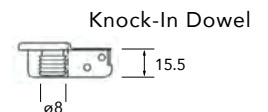
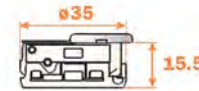

Code	Description	Ctn	List/ea
C2RBN99AC	94° Soft-Close, Inset B/C, Dowel	150 ea.	\$ 10.19

## BLIND CORNER HINGES

**SALICE**

### BLIND CORNER INSET HINGE FOR SMALLER SPACES: 15 x 32mm DRILLING

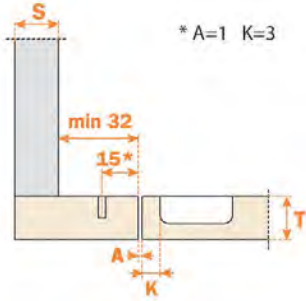

- 94° opening
- 11mm deep cup
- Possible drilling distance on the door (K): from 3 to 9mm.

Use above hinge with this plate

B2S3B99B6/15



Screw-on or dowels. Use with baseplate shown above. (Not compatible with DOMI® snap-on mounting plates)

Code	Description	Ctn	List/ea
C2PBN99	Screw-on	150 ea.	\$ 5.61
C2RBN99	Dowel	150	5.90
B2S3B99B6/15	Diecast Plate	50	2.13

### SOFT CLOSE OVERLAY BLIND CORNER HINGE

Silentia+, 700 Series, 110° opening

Soft-Close  
 Blind Corner Hinge  
 Dowelled  
 C7R6NE9AM



700 Series drills at 13.5 (17/32") depth

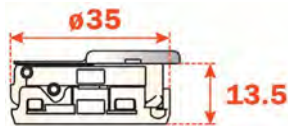
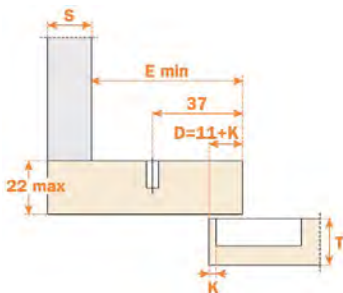

Code	Description	Ctn	List/ea
C7R6NE9AM	110° Blind Corner Overlay, Soft-Close	150	\$ 10.53

### OVERLAY BLIND CORNER HINGE

Self-Closing

Blind corner doors can now be easily mounted as overlay doors, to match the rest of the job!

- 110° opening
- 11mm deep cup



C2R6N99AM

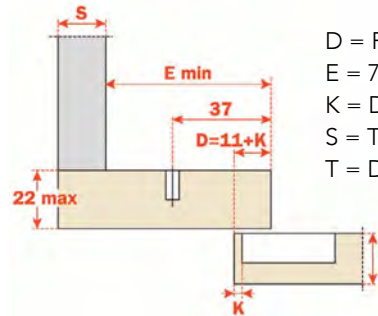

D = Required Door Overlay  
 E = 74mm  
 K = Drilling Distance  
 S = Thickness of Cabinet Side  
 T = Door Thickness

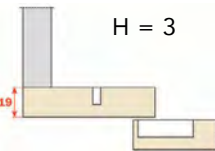
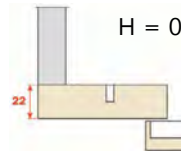

### Overlay

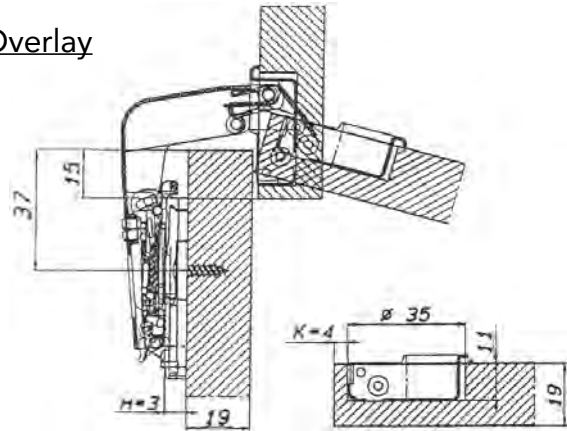

### Salice 110° Overlay Blind Corner Hinge

Gives a unique overlay application. Allows 18mm overlay with full adjustment and standard door prep. With dowels. Standard assembly uses 3mm baseplate.

Code	Description	Ctn	List/ea
C2R6N99AM	110°, Dowel	150 ea.	\$ 6.41



## SALICE

## TITANIUM FINISH

### SALICE TITANIUM FINISH HINGES & PLATES

Soft Close or Self Close



C1R6AE6

- Ideal in combination with darker interiors and shades of warm or exotic wood finishes
- Increased corrosion resistance
- Available in Soft-Close and standard self-close



*Titanium has a muted sheen ideal for many shades of wood.*



100 Series drills at 12mm depth. Titanium Finish.  
**105° Soft Close**, w/ Dowels. Pack: 300 ea.

Code	Description	List/ea
C1R6AE6	Titanium Silentia+ 105°, Full Overlay	\$ 5.78
C1R6DE6	Titanium Silentia+ 105°, 1/2" Overlay	5.98
C1R6GE6	Titanium Silentia+ 105°, Half Overlay	6.44
C1R6PE6	Titanium Silentia+ 105°, Inset	6.80

200 Series drills at 15.5mm depth. Titanium Finish.  
**94° Soft Close**, w/ Dowels. Thick Door. Pack: 300 ea.

C2RBAE6	Titanium 94°, Full Overlay	\$ 7.30
C2RBGE6	Titanium 94°, Half Overlay	7.50
C2RBPE6	Titanium 94°, Inset	7.80

700 Series drills at 13.5mm depth. Titanium Finish.  
**110° Soft Close**, w/ Dowels. Pack: 300 ea.

C7R6AE6	Titanium 110°, Full Overlay	\$ 6.41
---------	-----------------------------	---------

200 Series drills at 13.5mm depth, **Zero Protrusion**.  
**155° Soft Close**, w/ Dowels, Titanium Finish. Pack: 100 ea.

C2RKA66	Titanium 155°, Full Overlay	\$ 19.50
---------	-----------------------------	----------

200 Series drills at 11mm depth. Titanium Finish.  
**110° Self Close** w/ Dowels. Pack: 300 ea.

C2R6A66	Titanium 110°, Full Overlay	\$ 3.42
C2R6D66	Titanium 110°, 1/2" Overlay	4.20
C2R6G66	Titanium 110°, Half Overlay	3.90
C2R6P66	Titanium 110°, Inset	4.86

**94°, Self Close** w/ Dowels, Titanium Finish. Pack: 300 ea.

C2R6G66	Titanium 94°, Half Overlay	\$ 5.92
---------	----------------------------	---------

**94° F Series, Self Close**, Screw-In, Titanium Finish.  
 Pack: 300 ea.

Code	Description	List/ea
CFA7G66	Titanium 94°, 40mm Half Overlay	\$ 7.16
CFA7P66	Titanium 94°, 40mm, Inset	6.67

**165° Full Overlay, Self Close** w/ Dowels,  
 Titanium Finish. Pack: 100 ea.

C2RFA66	Titanium 165°, Full Overlay	\$ 7.75
---------	-----------------------------	---------

**Air Hinge, Soft Close**, Titanium Finish.

AIR-T	Titanium Air Hinge	\$ 88 /bg
-------	--------------------	-----------

**Pie Cut Corner, Self Close** w/ Dowels, Titanium Finish.  
 Pack: 150 ea.

C2RYA66	Titanium 165°, Pie Cut Corner	\$ 10.60
---------	-------------------------------	----------

**Baseplates**, Titanium Finish. Pack: 300 ea.

BAR3R06	0mm plate, screw-on	\$ 1.73
BARGR26/16	2mm plate w/ Euro screws	1.67
BAR3R26	2mm plate, screw-on	1.82
BAR3R36	3mm plate, screw-on	1.86
BAR3R66	6mm plate, screw-on	2.10
BAR3RV6	18mm plate, screw-on	4.74
BAU3R16	1mm Face Frame plate	2.40
BAU3R46	4mm Face Frame plate	2.50

**Accessories**, Titanium Finish. Pack: 100 ea.

S2XX85H6	Flange Cover Cap	\$ .40/ea
S2BX83H6	Arm Cover Cap	.25/ea
V136X156	Euro Screws, 14.5 x 5mm	17.91/C



# PUSH HINGES

# SALICE

## SALICE PUSH SYSTEM - Hands Free Opening

No Knobs or Pulls needed!

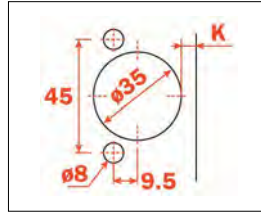

Springs inside the hinge open door 34° when door is pushed in.

Door momentum swings door up to it's degree of opening.

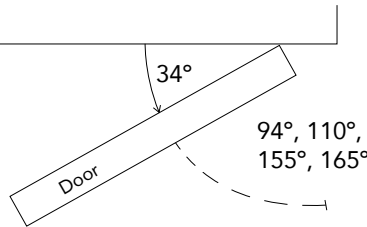

### Mechanical



**DP4SNB** - Beige  
**DP4SN3** - Black  
Release/Catch Device



**DP29SNB**  
Beige Recessed Catch Plate



**DP29SN3**  
Black Recessed Catch Plate



**DP29SNBR**  
Beige Surface Catch Plate



**DP29SN3R**  
Black Surface Catch Plate

### Magnetic



**DPMSNB**  
Release/Catch Device



**DP28SN9**  
Mag Catch Plate w/ Nail

### DP39XXG

Adjustable Magnetic Strike Plate

Inserts into door. Increases holding power and is ideal for larger, heavier doors. Features depth adjustment which enables precise alignment between the door and the magnet and can compensate for the possible bowing of the door.



## SALICE PUSH HINGE SYSTEM

- Allows for easy and complete opening of cabinet doors by lightly pressing on the door
- 94, 110, 155, 165° opening, 11mm deep metal cup (8.5mm deep cup for 155° hinges)
- Compatible with all standard Salice mounting plates
- Choose either a mechanical or magnetic Release/Catch device and Catch Plate

### For Each Door, Order:

2 ea. Hinges, 2 ea. Baseplates, 1 ea. Release/ Catch Device, and 1 ea. Catch Plate.

### Hinges

Code	Description	Ctn	List
C2RVA99	94° Full Ovly, Dowel	300	\$ 5.48 /ea
C2RVG99	94° Half Ovly, Dowel	300	5.77
C2RVP99	94° Inset, Dowel	300	6.26
C2RVN99AC	94° Blind Corner Inset, Dowel	150	10.98
C2PPA99	110° Full Ovly, Screw-in	300	6.04
C2RPA99	110° Full Ovly, Dowel	300	7.49
C2RPD99	110° 1/2" Ovly, Dowel	300	6.22
C2RPG99	110° Half Ovly, Dowel	300	7.71
C2RPP99	110° Inset, Dowel	300	9.66
CBPQAC9	110° Super Push Hinge for Thick Doors	50	15.00
C2RRA99	155° Full Ovly, Thick Door	100	14.50
C2RSA99	165° Full Ovly, Dowel	100	13.35
C2RSG99*	165° Half Ovly, Dowel	100	13.87
C2RSP99	165° Inset, Dowel	100	13.45

### Catches

DP4SNB	Beige Push Release Device	300	\$ 7.48 /ea
DP4SN3	Black Push Release Device	300	7.88
DP29SNB	Beige Recessed Push Catch	100	.64
DP29SN3	Black Recessed Push Catch	100	.55
DP29SNBR	Beige Surface Push Catch	100	1.25
DP29SN3R	Black Surface Push Catch	100	1.22
DPMSNB	Magnetic Release Device	200	10.49
DP28SN9	Mag plate w/ nail	200	15.43 /C
DP39XXG	Adj. Mag Strike Plate	100	8.99 /ea
DP50SNO	Push Insert Tool for DP29	100	.60
317.260.11	Push 26mm Drill Bit	1	47.66

# SALICE

# MINI HINGES

## SALICE SERIES 400 MINI HINGE 94°

- 11.5mm deep metal cup
- 26mm cup diameter
- 94° opening
- Possible drilling distance on the door (K): from 3 to 8mm
- Compatible with all traditional Series 200 mounting plates and with all DOMI® snap-on mounting plates



Code	Description	Ctn	List/ea
C4A7A99	94° Full Overlay, Screw-in	300	\$ 4.19
C4A7P99	94° Inset, Screw-in	300	4.95
317.260.11	26mm Drill Bit	1	47.66

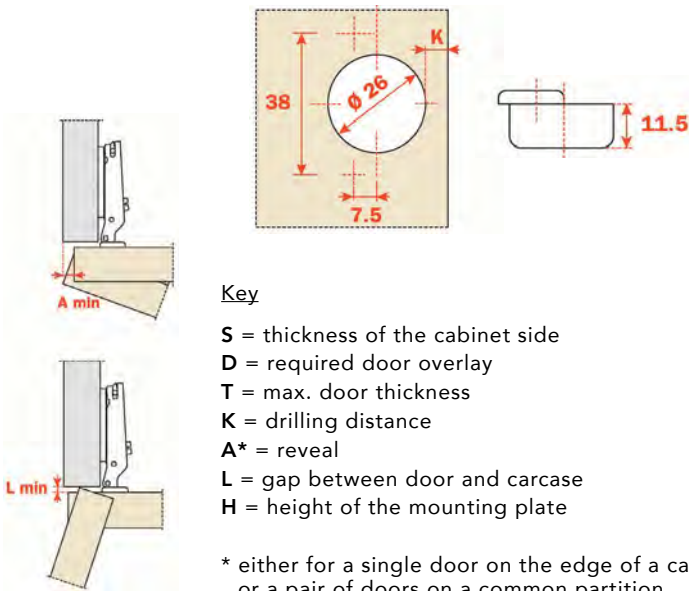

### Arm 0 / Full Overlay

C4A7A99

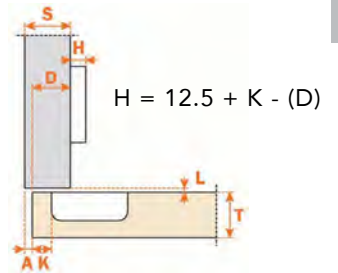

### Arm 17 / Inset

C4A7P99

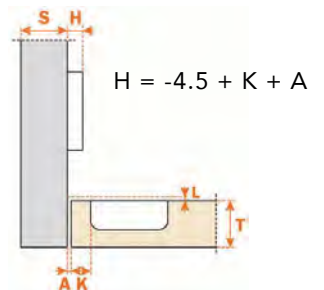

### Space needed to open the door

T=	16	17	18	19	20	21	22	23
K=3	A= 0.4	0.7	0.9	1.3	2.0	2.9	3.8	4.7
K=4	A= 0.4	0.6	0.9	1.1	1.6	2.4	3.3	4.2
K=5	A= 0.4	0.6	0.8	1.1	1.4	2.0	2.8	3.6
K=6	A= 0.4	0.6	0.8	1.0	1.2	1.8	2.4	3.2
K=7	A= 0.4	0.6	0.8	0.9	1.2	1.5	2.2	2.8
K=8	A= 0.4	0.6	0.8	0.9	1.2	1.5	1.9	2.6

K=	3	4	5	6	7	8
L=	0.0	0.0	0.0	0.7	1.7	2.6

The above values are calculated on the assumption that the doors have square edges. They are reduced if the doors have radiused edges.

$C = 16.5 + K + A$

### "C" Value

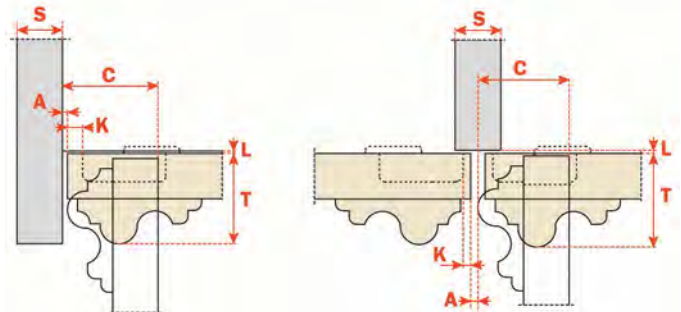

With this formula you can obtain the max. thickness of the molded door that can be opened without touching adjacent carcass sides, doors or walls, while bearing in mind the L-K-T values.



## AIR HINGES

## SALICE

### AIR Hinge - Soft Close, Nickel & Titanium finishes



Air is an innovative and revolutionary hinge which, despite its compactness and small size, delivers full functionality to furniture manufacturers. Fully adjustable in three directions and incorporates an **integrated soft close mechanism**.

It inserts into the top and bottom of the cabinet and door and is practically invisible. Its small size means that the applications for Air are numerous: kitchens, bathrooms, living and bedroom furniture or display cabinets. 105° opening. For reduction to 92°, use with SEL637X3 reduction clip.

- 105° opening
- Nickel & Titanium finishes
- 16.5mm deep cup
- For min. 11/16" (18mm) thick wood doors and for aluminum framed doors
- Max. door weight 44 lbs (20 Kgs)
- Max. dimensions of the door:  
82-11/16" (2100mm) Height x  
23-5/8" (600mm) Width



Nickel finish



Titanium finish

One bag contains 2 hinges and fixing screws.

Code	Description	List
AIR-NI	Air Hinge door set, Nickel finish	\$ 82.53 /bg
AIR-T	Air Hinge door set, Titanium finish	88.00
SEL637X3	Reduction clip for Air hinge, limits opening to 92°	33.54 /C

### AIR Hinge - Push to Open, Nickel Finish (Titanium finish avail. special order)



The Air hinge is also available in Push-to-Open. Hinges are equipped with a special spring for the opening of handle-less doors. 105° opening. For reduction to 92°, use with SEL637X3 reduction clip.

Sold per bag. Bag contains Two Self-Open hinges and fixing screws. Must order Magnetic Push Release and Plate separately (choose one plate) to complete application.

Code	Description	List
AIR-PUSH-NI	Push to Open Air hinge, Nickel finish	\$ 88.30 /bg
DPMSNB	Magnetic Release Device	10.49 /ea
DP28SN9	Mag Plate w/ nail	15.43 /C
DP39XXG	Adjustable Mag Strike Plate	8.99 /ea
SEL637X3	Reduction clip for Air hinge, limits opening to 92°	33.54 /C

# SALICE

# AIR HINGES

## AIR Hinge specs

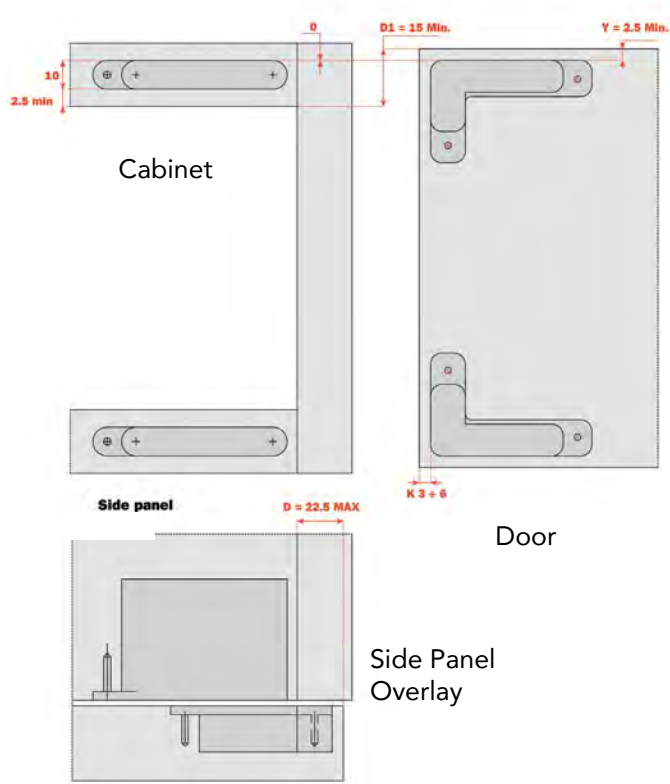

## Boring Dimensions

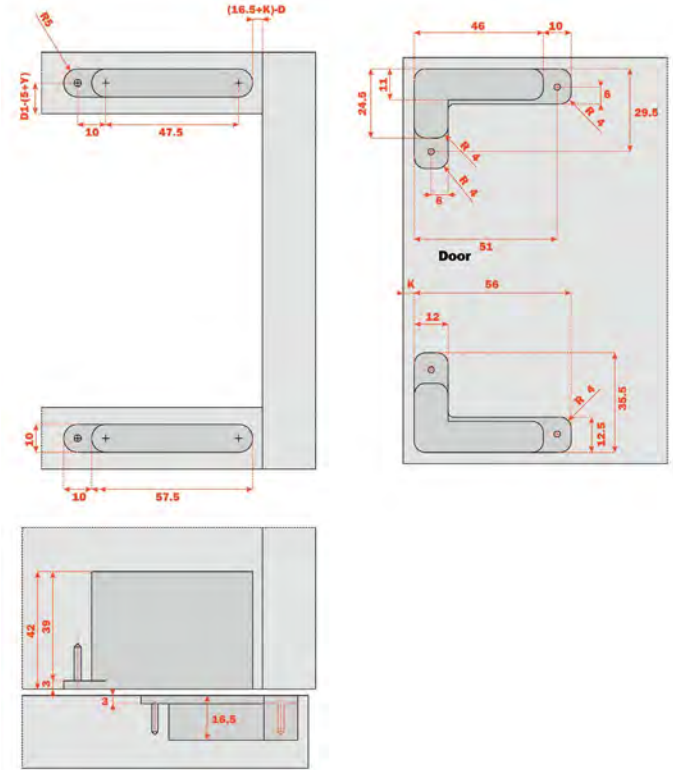

7

## Air Drilling Templates Sets Special Order

Each Template Set includes:

Template bases, aluminum alignment rails, mounting hardware with wrenches, router collets & cutters, instruction sheets and thumb drive with "how to" videos.

### TZTMPLTCAB



### TZTMPLTDR



Code	Description
TZTMPLTCAB*	Template for Cabinet
TZTMPLTDR*	Template for Door

\*Special Order - Call for Price



# GLASS DOOR HINGES

# SALICE

Arm 0 / Full Overlay  
C2C7A39

$$H = 12.5 + K - (D)$$

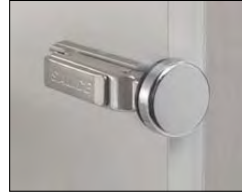
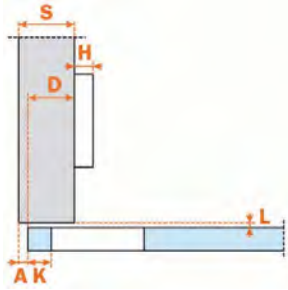

- 94° Opening
- Screw-in, Self-Closing
- Clip-on or Slide on depending on baseplate used

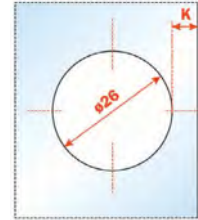

Possible drilling distance on the door (K): from 5.5 to 6.5mm. Hole diameter 26mm. For use with glass of 4mm to 6mm thickness.

7

Arm 9 / Half Overlay  
C2C7G39

$$H = 3.5 + K - (D)$$

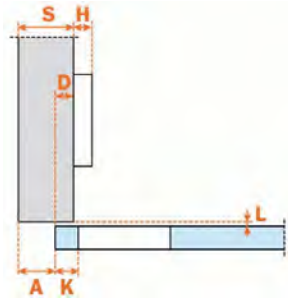

Code	Description	Ctn	List/ea
C2C7A39	94°, Full Overlay	150	\$ 5.21
C2C7G39	94°, Half Overlay	150	7.76
C2C7P39	94°, Inset	150	5.93

## ROUND NYLON CAPS



P2CTA



Arm 17 / Inset  
C2C7P39

$$H = -4.5 + K + A$$

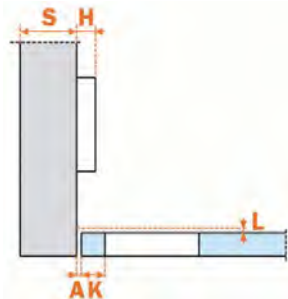

Code	Description	Ctn	List/ea
P2CTA06	Nylon, Bright Chrome	300	\$ 1.26
P2CTA08	Nylon, Bright Gold	300	2.44
P2CTAX3	Nylon, Black	300	.58

### Key

- S = thickness of the cabinet side
- D = required door overlay
- T = max. door thickness
- K = drilling distance
- A\* = reveal
- L = gap between door and carcass
- H = height of the mounting plate

\* either for a single door on the edge of a case or a pair of doors on a common partition.



## HINGE BORING BITS

### CMT CARBIDE TIPPED BORING BITS

"Fatigue proof" Swiss steel body, micrograin carbide tips, bake-on non-stick coating and honed edges. Made in Italy. Negative ground spurs on boring bits give clean cuts in melamine without chipping.

#### HINGE BORING BIT

CMT

Overall Length: 57.5mm



Size	RH	List/ea
26mm	317.260.11	\$ 47.66
35mm	317.350.11	42.08
40mm	317.400.11	64.41

### BOSCH CARBIDE TIPPED BORING BITS

Industrial Carbide Tipped. Shank Size: 10mm x 20mm.

Overall Length: 57mm. With adjustable top screw.



Code	Hand	Dia.	List/ea
T15040	RH	40mm	\$ 50.16

Boring bits for multi-spindle machines. Use on most automatic & semi-automatic boring machines. Fits almost any European boring machines. Max. Boring Depth: 36mm. Shank: 10 x 26mm. Overall Length: 57mm. With adjustable top screw. Positive grind for hardwoods.



Shank: 10 x 26mm with adjustable top screw

Code	Hand	Dia	List/ea
T15018	LH	8mm	\$ 25.41
T15008	RH	8mm	25.42

## HINGE INSERTION TOOL

### CMT HINGE BORING SYSTEM for Salice Hinges

For hinges with a distance of 45mm and an offset of 9.5mm to the center of the main hinge hole. Salice/Blum pattern.

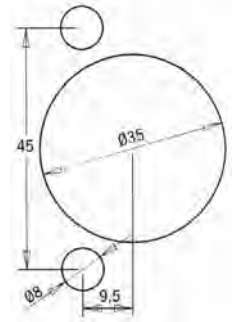

For use on drill presses



For use with portable drills

The complete system CMT333-03 contains:

- CMT333 the modular base support
- CMT333-4595 boring head
- 317.350.11 ø35mm hinge boring bit

Code	Description	List/ea
CMT333-03	Hinge Boring System	\$ 505.50

## HINGE MACHINES

## SALICE

### SALICE MANUAL OMAL HINGE MACHINE

TOMICMAN

Special  
Order Only

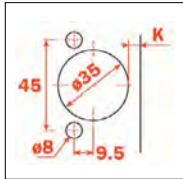

#### TOMICMAN Standard Equipment

- 1.5 HP motor
- Interchangeable 3 spindle gearbox (boring pattern 45 x 9,5)
- Center fence
- Table (700mm x 400mm) 27.5" x 15.75"
- 2 tilt stops (to index panels on the fence)
- Insertion RAM
- Set of drill bits - 1 x 35mm RH bit + 2 x 8mm LH bits
- Tool kit
- Operators manual

#### Optionals:

- Insertion RAM for 165° opening hinges.

#### Technical Data:

- |                  |                                |
|------------------|--------------------------------|
| • Motor          | 1,1 KW - 1,5 hp - 60 Hz        |
| • Voltage        | 110/1 ph                       |
| • Shank diameter | Ø 10mm                         |
| • Table size     | 700mm x 400mm (27.5" x 15.75") |
| • Weight         | 35 kg/ 77 lbs.                 |

The OMAL TOMICMAN MANUAL drilling and insertion machine is designed to drill and insert SALICE hinges. Manually operated with a pull-down lever.

**SAFETY:** Motor activated ONLY during drilling operations; stops during the insertion phase. Conforms with the latest safety guidelines.

Code	Description	List/ea
TOMICMAN	Omhal Manual,110V/1 phase	CALL

### SALICE "EASY" OMAL HINGE MACHINE

TOMINI110

Special  
Order Only

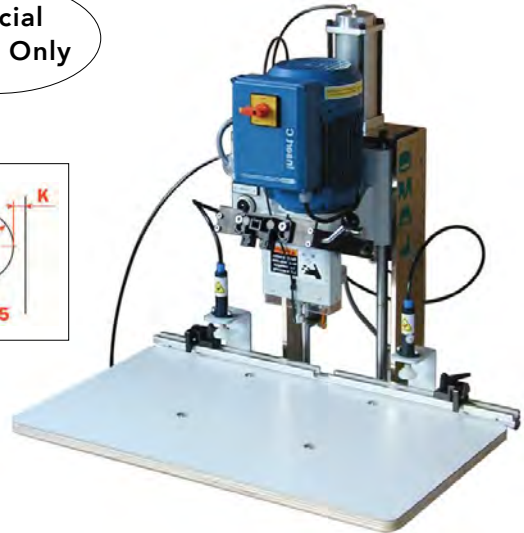
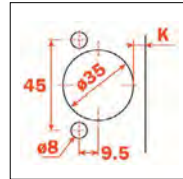

#### TOMINI110 Standard Equipment:

- 1.5 HP motor
- 3 spindle gearbox (boring pattern 45x9,5)
- Center fence
- Table (700mm x 400mm) 27.5" x 15.75"
- 2 tilt stops (to index panels on the fence)
- Insertion RAM
- Set of drill bits - 1 x 35 mm RH bit + 2x8 mm LH bits
- Tool kit
- Operator manual

#### Technical Data:

- |                                     |                                  |
|-------------------------------------|----------------------------------|
| • Interchangeable 3 spindle gearbox |                                  |
| • Motor                             | 1,1 KW - 1,5 hp - 60 Hz          |
| • Voltage                           | 110/1 ph                         |
| • Shank diameter                    | Ø 10 mm                          |
| • Required air pressure             | 6 bar/85 Psi                     |
| • Table size                        | 700 mm x 400 mm (27.5" x 15.75") |
| • Weight                            | 40 Kg/ 88 lbs.                   |

The OMAL drilling and insertion machine is designed to drill and PNEUMATICALLY insert SALICE hinges thus eliminating operator fatigue.

**SAFETY:** A special electronic device activates the motor ONLY during drilling operations, the motor stops during the insertion phase. The machine is designed to conform with the latest safety guidelines.

Code	Description	List/ea
TOMINI110	Easy Omhal Hinge Machine	CALL



## SALICE

## HINGE MACHINES

### SALICE OMAL HINGE MACHINES

The OMAL drilling and insertion machine is designed to drill and PNEUMATICALLY insert SALICE hinges.

**SAFETY:** A special electronic device activates the motor ONLY during drilling operations, the motor stops during the insertion phase. The machine is designed to conform with the latest safety guidelines.

#### STANDARD EQUIPMENT:

- 1.5 HP motor
- 5 spindle gearbox, boring pattern 45 x 9.5 (Salice/Blum pattern)
- Center fence
- Table (700 mm x 400 mm)
- Right hand and left hand extension rulers (700 mm / 2' 4" each)
- 4 tilt stops (to index panels on the fence)
- Pneumatic (6 bar, 85 Psi) hold down clamps
- Universal insertion RAM
- Set of drill bits - 1 x 35 mm RH bit + 2 x 8 mm LH bits
- Operators manual, Tool kit

#### Optional Equipment:

- 7 spindle line drilling head  
Item # TODRHD7
- Dust-collecting exhaust device  
Item # TOMEXDEV



**Special Order Only**

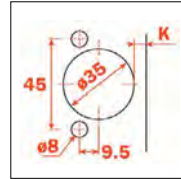

#### Exclusive Features

Digital Adjustment Dials for drilling depth and distance from door edge.



Drilling Distance



Depth

#### TECHNICAL DATA

- Interchangeable 5 spindle gearbox
- Motor: 1.1 KW - 1.5 hp - 60Hz
- Voltage: 110 / 1 ph, 220 / 1 ph, 220 / 3 ph
- Shank diameter: Ø 10 mm
- Required air pressure: 6 bar / 85 Psi
- Table size: 700 mm x 400 mm (27.5" x 15.5")
- Weight: 65 kg / 150 lbs

<u>Code</u>	<u>Description</u>
TOMIC110*	110V 1-phase
TOMIC216*	220V 1-phase
TOMIC236*	220V 3-phase

All Special Order  
 - Call for Price

### SALICE OMAL MACHINE ACCESSORIES



7-Spindle Drill Head

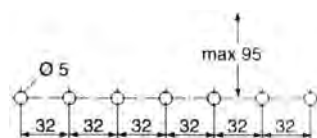

Boring pattern  
 7-spindle-drillhead

<u>Code</u>	<u>Description</u>
TODRHDS*	7-spindle Drillhead with Guide for Tomic 110, 216, 236 only
TBRAM165*	Insertion Ram 165°
TDB5708L*	5mm Drill Bit LH
TDB5735R*	35mm Drill Bit
TKRAM110	Insertion Ram 110°

All Special Order  
 Call for Price

List \$ 123.06

## SALICE ACCESSORIES

### SALICE HINGE ACCESSORIES



#### Salice Screwdriver

Code List/ea  
 D2A7XCXCP

#### Reduction Clips



**S2A637XF**  
 Stop device for all hinges with 94° opening and 35mm cup. It limits the opening to 86°.

#### Installation:



**S1E637XY**  
 For all Series 100 and 700 Silentia hinges. It limits the opening to 86°.



#### Installation:



**S2AF37X3**  
 Reduction clip for 165° hinges. Limits the opening to 140°.



**S2BF37XY**  
 Reduction clip for 165° hinges. Limits the opening to 135°.



**S2BH37XG**  
 Reduction clip for C2RHA99 hinges. Limits the opening to 110°.



**SUP337XG**  
 Reduction clip for face frame compact hinges. Limits the opening to 86°.



**SEL637X3**  
 Reduction clip for Air Hinges. Limits the opening to 92°

#### Installation:

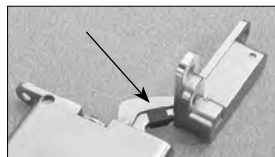

Code	Description	Ctn	List/C
S2A637XF	94° to 86° Clip	500	\$ 50.00
S1E637XY	105/110° to 86° Clip	500	25.82
S2AF37X3	155/165° to 140° Clip	100	33.06
S2BF37XY	155/165° to 135° Clip	100	69.05
S2BH37XG	155° to 110° Clip	100	41.45
S2BM37XG	155° to 95° Clip	100	38.42
SUP337XG	106° to 86° Clip for FF hng	100	30.59
SEL637X3	105° to 92° Clip for Air hng	100	33.54

### SALICE HINGE ACCESSORIES cont.

#### EURO SCREWS

Pozi Drive Pan Head



13mm/Short  
 #V236X104

Plastic Dowels



17mm/Standard  
 #V236X144



Screws for Dowels



Screw Cover Caps  
 (Custom orders available)

**S2BX83H9** - Steel  
**S2XX83A3** - Black Plastic



Steel Flange Cover Caps

**S2XX85H9**  
 For 200 series doweled/undoweled hinges.

Code	Description	Ctn	List/C
V236X104	13mm Euro Screw	100	\$ 11.15
V236X144	17mm Euro Screw	100	12.20
V284X114	Screws for Dowel	500	6.11
S2R660XY	8mm Dowel	1000	8.00
S2B760XG	10mm Dowel	1000	4.53
S10E60XY	8.5mm Flat Dowel	5000	7.74
S2XX83A3	Cover Cap, Black	500	6.59
S2BX83H9	Cover Cap, Steel	4000	.19/ea
S2XX85H9	Steel Flange Cover Cap 200 Series	1000	37.48/C
S9XX85H9*	Steel Flange Cover Cap 200 Series - Rapido Hgs	1000	CALL

Also available in  
**Titanium:** Cover caps,  
 Euro screws, 14.5 x 5mm



#### Accessories, Titanium Finish. Pack: 1000 ea.

S2XX85H6	Flange Cover Cap	.40/ea
S2BX83H6	Arm Cover Cap	.25/ea
V136X156	Euro Screws, 14.5 x 5mm	17.91/C



# SALICE

# SMOVE

## SMOVE FROM SALICE

The First Shock-Absorber for Doors!



Slows, quiets, and cushions the closing of doors and drawers.

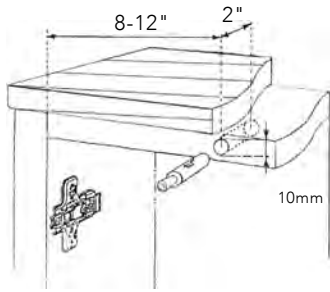

Insert SMOVE into the 10mm hole. (For 10mm drill bit use 570-7100)



Insert SMOVE into the appropriate adapter and fix it under the top panel on the base panel or face frame.



## SMOVE SOFT CLOSE FOR FACE FRAMES!

See next page for adapters

Easy Mounting for Overlay Doors

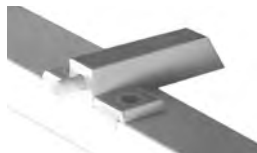

## SMOVE D005 - Low Resistance



Can be installed on the cabinet's vertical side opposite the hinge as well as on the top panel opposite the hinge.

Code	Color	Ctn	List/ea
D005SNB	Beige	300	\$ 4.54
D005SNQ	Honey (Md. Brown)	300	4.26

## SMOVE D006 - Medium Resistance



Variable positioning for adjustment of closing speed.

Installed to strike approx. in the center of the door. Optimum performance is determined by a test block. Usually mounted along the top edge of the cabinet.

Code	Color	Ctn	List/ea
D006SNB	Beige	300	\$ 4.77
D006SNQ	Honey (Md. Brown)	300	4.45
D006SNG	Gray	300	4.46

## SMOVE D007 - Medium-High Resistance



Installation on cabinet top panel near the hinge side of the door.

Code	Color	Ctn	List/ea
D007SNG	Gray	300	\$ 4.22

## SMOVE D008 - Maximum Resistance



Installation on cabinet top panel near the hinge side of the door.

Code	Color	Ctn	List/ea
D008SNB	Beige	300	\$ 4.94
D008SNQ	Honey (Md. Brown)	300	4.41

## SMOVE

## PUSH LATCHES

### SMOVE ADAPTERS



Euro Adapter w/Lip  
 D064SNBN - Beige



Adapter For Overlay  
 D066SNBN - Beige  
 D066SNQN - Honey  
 (Brown)



Metal Adapter  
 D076SN9R - w/ tabs  
 D076XX9R - No tabs,  
 For Inset

Code	Description	Ctn	List/ea
D064SNBN	Euro Adapter w/Lip, Beige	500	\$.48
D066SNBN	For Overlay, Beige	300	.40
D066SNQN	For Overlay, Honey (Brn)	300	.35
D076SN9R	Chrome Metal Adapter W/ Tabs	300	2.33
D076XX9R	Chrome Metal Adapter, No Tabs, For Inset	300	1.70

### METRIC BRAD POINT DRILL BIT - 10MM



570-7100

Excellent quality High Speed Steel woodworking bit. Designed for standard 3-jaw chucks. Carded, 1 ea/cd.

Code	Dia.	Overall Length	List/ea
570-7100	10mm	130mm (5")	\$ 27.27

### SALICE MAGNETIC PUSH LATCH

Release device and strike plate sold separately



**DPMSNB**  
 Release Device

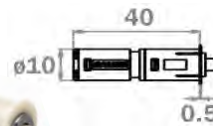

**DP28SN9**  
 Mag plate w/ nail

For use with Salice Push hinges: pg. 745.

### DP84SNBR

Adjustable Plastic Adapter for Release Device

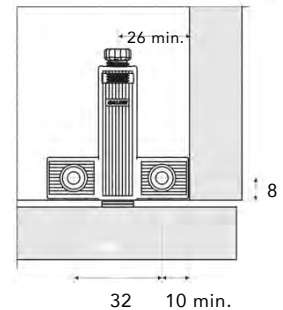

Plastic adapter for release device. To be fixed with woodscrews. 8x32 mm drilling. Beige in color. With assembly stop devices.

### DP39XXG

Adjustable Magnetic Strike Plate



Inserts into door. Increases holding power and is ideal for larger, heavier doors. Features depth adjustment which enables precise alignment between the door and the magnet and can compensate for the possible bowing of the door.



Can be used in conjunction with Touch Latches:



See pg 600 for more latches.

Code	Description	List
DPMSNB	Magnetic Release Device	\$ 10.49 /ea
DP28SN9	Mag plate w/ nail	15.43/C
DP84SNBR	Adjustable Plastic Adapter	2.81 /ea
DP39XXG	Adjustable Magnetic Strike Plate	8.99



## SALICE

## SMOVE

### SALICE UNIVERSAL SMOVE



- Use on frame or frameless cabinets
- Adjustable for door styles, weights & overlay applications
- Mounts with #6 x 5/8" wood screw
- Precise positioning with front locator tab
- D0LHSNG is non-handed. One Smove for either left or right side mounting
- Only 1 Smove required per door
- Low profile for minimal cabinet space intrusion
- Satin finish on metal case

Overlay Doors  
Location

Easy to use  
locator tabs

Specifications

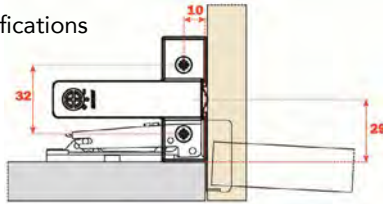

<u>Code</u>	<u>Description</u>	<u>Ctn</u>	<u>List/ea</u>
D0LHSNG	For Overlay (with tab)	150	\$ 4.48
D0ULOG	Left Corner, FF application	300	5.08
D0UR0G	Right Corner, FF application	300	5.08

### SALICE SMOVE for EURO "CLIP TO PLATE"

D0SHSNG



"Clip-to-Plate" Smove for soft close in frameless cabinets.

- Hinge stays adjustable
- Adjustable close speed
- Hinge adjusts with Smove attached
- Easy to mount after hinge installation
- Contacts hinge flange, not door (no door marring)
- Low profile: Smooth appearance
- Only 1 Smove required per door

<u>Code</u>	<u>Description</u>	<u>Ctn</u>	<u>List/ea</u>
D0SHSNG	Clip to Plate Smove	300	\$ 4.87
D0S9SNG	Clip to Plate Smove, for 3+ hinge applications	300	4.54

### Smove Die-Cast Adapters Clip to Euro 'BAR' Plates



<u>Code</u>	<u>Description</u>	<u>Ctn</u>	<u>List/ea</u>
DARX09	For Full Overlay hinges	300	\$ 1.25
DARX59	For 1/2" Overlay hinges	300	1.07
DARX99	For Half Overlay hinges	300	2.19
DARXP9	For Inset hinges	300	3.24



## UNISOFT

### GRASS UNISOFT

Soft Close for Doors

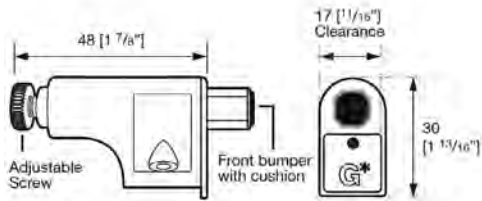
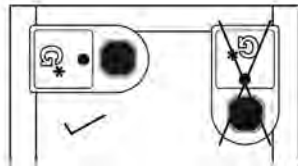
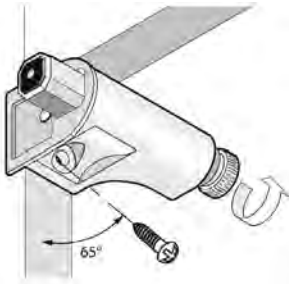

- Works for face frame cabinets on all door overlays
- Works for frameless cabinets on full overlay doors
- Blends in well with hinge finish
- Non-handed
- Manually adjustable to desired closing speed
- Easy to mount by locating in the corner
- Pilot Drill 3/32" and 1/4" deep for a #6 x 3/4 Pan Head screw recommended
- Does not work with Salice compact hinge

Code	Description	Ctn	List
18971	Unisoft Soft-Close	250	\$ 5.34/ea
18971-37	Unisoft -polybagged w/screws, instructions	125	7.20/bg
151-332	Drill bit, 3/32	1	3.00/ea
34-6 PHPT	3/4 x 6 Phil PHTS	100	6.60/C

## SOFT CLOSE

### TIOMOS M9 110° HINGE: For Thin Doors

Soft-Close

Designed for thin cabinet doors with a very shallow cup drilling depth of only 9mm making it suitable for 12mm (1/2") doors. Soft-close, screw-on, nickel plated.



- Accommodates overlays up to 25mm (1")
- For door thicknesses from 12mm (1/2") to 28mm (1-1/8")
- For Faceframe or Frameless cabinets



Code	Description	Ctn	List/ea
T29-338	Tiomos M9, 110° hinge	50	\$ 21.98

**GRASS**

**TIOMOS 95° HINGES**

**Tiomos 95 3 Speed Soft Close  
 95° hinge for Thick doors**



- 3 dimensional adjustment with suitable baseplate
- Accommodates overlays up to 24mm (15/16")
- Optimal reveal up to 36mm (1-7/16") door thickness
- For face frame or frameless cabinets
- Convenient depth adjustment with worm gear
- Soft close, 3 speed adjustable for door size & weight

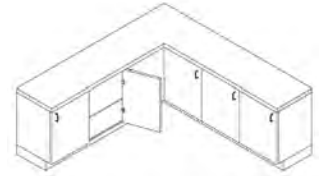

**Full Overlay / Cranking 00 / 45mm Drilling Pattern, Dowelled**



Code	Description	Ctn	List
T28-571	95° Full Overlay, Soft-Close, Dowel	150	\$ 7.31



**Full Overlay**

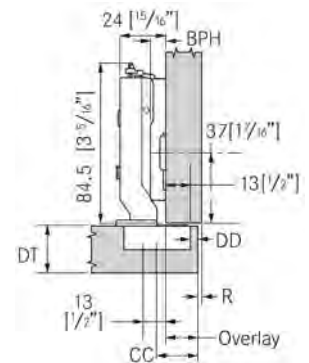

**Inset / Cranking 19 / 42/45mm Drilling Pattern, Impresso**



Code	Description	Ctn	List
T17-441	95° Inset, Soft-Close, Impresso (Tool-Free)	150	\$ 9.62



**Inset**

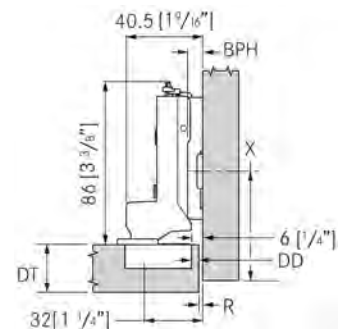

**Minimum gaps**

The minimum gap is the gap between the closed door and the front of the cabinet.

Door Thickness	Drilling Distance (DD)					Minimum gap
	3	4	5	6	7	
36.0	1.0	1.0	1.0	1.0	2.4	
30.0	1.0	1.0	1.0	1.0	1.8	
28.0	1.0	1.0	1.0	1.0	1.7	
26.0	1.0	1.0	1.0	1.2	1.5	
24.0	1.0	1.0	1.0	1.0	1.5	
22.0	1.0	1.0	1.0	1.0	1.5	
20.0	1.0	1.0	1.0	1.0	1.0	
18.0	1.0	1.0	1.0	1.0	1.0	
16.0	1.0	1.0	1.0	1.0	1.0	

**Reveal**

Reveal dimensions were determined with an edge radius (of the door) of 1mm! Hinge dimensions and reveal calculation based on factory setting.

**IMPORTANT** To determine the correct application Grass strongly recommends a trial mounting for all hinges and base plates.

Door Thickness	Drilling Distance (DD)					Reveal (R)
	3	4	5	6	7	
36.0	10.5	10.0	8.6	7.6	6.7	
30.0	4.0	3.0	2.5	1.9	2.4	
28.0	2.0	1.5	1.5	1.3	1.3	
26.0	1.0	1.0	1.0	1.0	1.0	
24.0	0.6	0.6	0.6	0.6	0.6	
22.0	0.5	0.5	0.5	0.5	0.5	
20.0	0.3	0.3	0.3	0.3	0.3	
18.0	0.2	0.2	0.2	0.2	0.2	
16.0	0.2	0.2	0.2	0.2	0.2	

**Impresso and Dowelled**

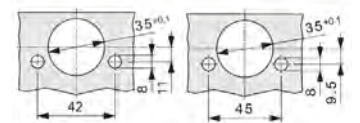

**Cup dimensions**

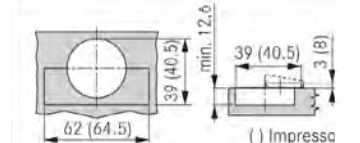

**TIOMOS 110° HINGES****GRASS****Tiomos 110 3 Speed Soft Close  
110° hinge for Standard doors**

- Adjustable 3 speeds for door size and weight
- 3 dimensional door adjustment
- Allows overlays up to 24mm (15/16")
- Optimal reveal up to 24mm door thickness
- Soft-close or Self-close hinges available
- For face frame or frameless cabinets
- Convenient depth adjustment with worm gear
- 12.6mm cup bore depth

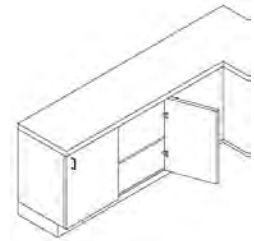

- Concealed Soft-Close

Pack: 150 each/Ctn.

7

**Full Overlay / Cranking 00**

Screw-On / 45



Dowelled / 45



Dowelled / 42



Impresso 42/45

	Type	Code	List	Code	List	Code	List	Code	List
 Hinge cup/arm: steel, nickel plated	Soft Close	T28-519	\$ 7.47	T28-523	\$ 7.42	T28-341	\$ 8.70	T17-414	\$ 9.52
	Self Close	-		-		T45-279	5.52	T34-385	3.78

**Overlay / Cranking 03**

	Type	Code	List	Code	List	Code	List	Code	List
 Hinge cup/arm: steel, nickel plated	Soft Close	T28-520	\$ 6.17	T28-524	\$ 6.16	T28-342	\$ 5.52	T17-415	\$ 8.09
	Self Close	T45-458	2.56	T45-462	2.62	T45-280	3.33	T34-386	3.86

**Half Overlay / Cranking 9.5**

	Type	Code	List	Code	List	Code	List	Code	List
 Hinge cup: steel, nickel plated Hinge arm: zinc, nickel plated	Soft Close	T28-521	\$ 7.12	T28-525	\$ 8.40	T28-343	\$ 7.96	T17-416	\$ 11.70
	Self Close	T45-459	4.01	T45-463	3.32	T45-281	4.39		

**Inset / Cranking 19**

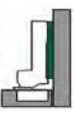
	Type	Code	List	Code	List	Code	List	Code	List
 Hinge cup: steel, nickel plated Hinge arm: zinc, nickel plated	Soft Close	T28-522	\$ 9.05	T28-526	\$ 10.02	T28-344	\$ 7.59	T17-417	\$ 12.13
	Self Close	-		-		-			

**Opening Angle  
Reduction Clip to 85°**

Black Plastic



Code	Ctn	List/ea
T72-751	50	\$ 1.29

**Hinge Arm Cover Cap**

Steel, Nickel Plated



Code	Ctn	List/ea
T72-500	1000	\$ .59

**Wood Screw, Nickel Plated**

#6 x 5/8" FHP, NI



Code	Ctn	List/bg
81001	500/bg	\$ 36.17



**GRASS**

**TIOMOS 110° HINGES**

110° Specifications

Full overlay	Overlay	Half overlay	Inset																																																																																																																																																																																																																																																																																																																																																
 Drawing shows Tiomos with a base plate height (BPH) 02. Drilling Distance (DD) table: <table border="1"> <tr><th>DD</th><th>3</th><th>4</th><th>5</th><th>6</th><th>7</th></tr> <tr><td>22.0</td><td></td><td></td><td></td><td></td><td>0</td></tr> <tr><td>21.0</td><td></td><td></td><td></td><td>0</td><td></td></tr> <tr><td>20.0</td><td></td><td>0</td><td></td><td>2</td><td></td></tr> <tr><td>19.0</td><td>0</td><td></td><td>2</td><td>3</td><td></td></tr> <tr><td>18.5</td><td></td><td></td><td></td><td>3.5</td><td></td></tr> <tr><td>18.0</td><td>0</td><td>2</td><td>3</td><td></td><td></td></tr> <tr><td>17.5</td><td></td><td></td><td>3.5</td><td></td><td></td></tr> <tr><td>17.0</td><td>2</td><td>3</td><td></td><td></td><td></td></tr> <tr><td>16.5</td><td></td><td>3.5</td><td></td><td></td><td></td></tr> <tr><td>16.0</td><td>2</td><td>3</td><td></td><td></td><td></td></tr> <tr><td>15.5</td><td></td><td>3.5</td><td></td><td></td><td></td></tr> <tr><td>15.0</td><td>3</td><td></td><td></td><td></td><td></td></tr> <tr><td>14.5</td><td>3.5</td><td></td><td></td><td></td><td></td></tr> <tr><td></td><td colspan="5">Base Plate Height (BPH)</td></tr> </table>	DD	3	4	5	6	7	22.0					0	21.0				0		20.0		0		2		19.0	0		2	3		18.5				3.5		18.0	0	2	3			17.5			3.5			17.0	2	3				16.5		3.5				16.0	2	3				15.5		3.5				15.0	3					14.5	3.5						Base Plate Height (BPH)					 Drawing shows Tiomos with a base plate height (BPH) 02. Drilling Distance (DD) table: <table border="1"> <tr><th>DD</th><th>3</th><th>4</th><th>5</th><th>6</th><th>7</th></tr> <tr><td>19.0</td><td></td><td></td><td></td><td></td><td>0</td></tr> <tr><td>18.0</td><td></td><td></td><td></td><td>0</td><td></td></tr> <tr><td>17.0</td><td></td><td></td><td>0</td><td>2</td><td></td></tr> <tr><td>16.5</td><td></td><td></td><td></td><td></td><td></td></tr> <tr><td>16.0</td><td>0</td><td></td><td>2</td><td>3</td><td></td></tr> <tr><td>15.5</td><td></td><td></td><td></td><td>3.5</td><td></td></tr> <tr><td>15.0</td><td>0</td><td>2</td><td>3</td><td></td><td></td></tr> <tr><td>14.5</td><td></td><td></td><td>3.5</td><td></td><td></td></tr> <tr><td>14.0</td><td>2</td><td>3</td><td></td><td></td><td></td></tr> <tr><td>13.5</td><td></td><td></td><td>3.5</td><td></td><td></td></tr> <tr><td>13.0</td><td>2</td><td>3</td><td></td><td></td><td></td></tr> <tr><td>12.5</td><td></td><td>3.5</td><td></td><td></td><td></td></tr> <tr><td>12.0</td><td>3</td><td></td><td></td><td></td><td></td></tr> <tr><td>11.5</td><td>3.5</td><td></td><td></td><td></td><td></td></tr> <tr><td></td><td colspan="5">Base Plate Height (BPH)</td></tr> </table>	DD	3	4	5	6	7	19.0					0	18.0				0		17.0			0	2		16.5						16.0	0		2	3		15.5				3.5		15.0	0	2	3			14.5			3.5			14.0	2	3				13.5			3.5			13.0	2	3				12.5		3.5				12.0	3					11.5	3.5						Base Plate Height (BPH)					 Drawing shows Tiomos with a base plate height (BPH) 02. Drilling Distance (DD) table: <table border="1"> <tr><th>DD</th><th>3</th><th>4</th><th>5</th><th>6</th><th>7</th></tr> <tr><td>12.5</td><td></td><td></td><td></td><td></td><td>0</td></tr> <tr><td>11.5</td><td></td><td></td><td></td><td>0</td><td></td></tr> <tr><td>10.5</td><td></td><td></td><td>0</td><td>2</td><td></td></tr> <tr><td>10.0</td><td></td><td></td><td></td><td></td><td></td></tr> <tr><td>9.5</td><td>0</td><td></td><td>2</td><td>3</td><td></td></tr> <tr><td>9.0</td><td></td><td></td><td></td><td>3.5</td><td></td></tr> <tr><td>8.5</td><td>0</td><td>2</td><td>3</td><td></td><td></td></tr> <tr><td>8.0</td><td></td><td></td><td>3.5</td><td></td><td></td></tr> <tr><td>7.5</td><td>2</td><td>3</td><td></td><td></td><td></td></tr> <tr><td>7.0</td><td></td><td></td><td>3.5</td><td></td><td></td></tr> <tr><td>6.5</td><td>2</td><td>3</td><td></td><td></td><td></td></tr> <tr><td>6.0</td><td></td><td>3.5</td><td></td><td></td><td></td></tr> <tr><td>5.5</td><td>3</td><td></td><td></td><td></td><td></td></tr> <tr><td>5.0</td><td>3.5</td><td></td><td></td><td></td><td></td></tr> <tr><td></td><td colspan="5">Base Plate Height (BPH)</td></tr> </table>	DD	3	4	5	6	7	12.5					0	11.5				0		10.5			0	2		10.0						9.5	0		2	3		9.0				3.5		8.5	0	2	3			8.0			3.5			7.5	2	3				7.0			3.5			6.5	2	3				6.0		3.5				5.5	3					5.0	3.5						Base Plate Height (BPH)					 Drawing shows Tiomos with a base plate height (BPH) 02. X = 38.5 + DT Drilling Distance (DD) table: <table border="1"> <tr><th>DD</th><th>3</th><th>4</th><th>5</th><th>6</th><th>7</th></tr> <tr><td>0.0</td><td></td><td>0</td><td></td><td>2</td><td>3</td></tr> <tr><td>0.5</td><td></td><td></td><td></td><td></td><td>3.5</td></tr> <tr><td>1.0</td><td>0</td><td></td><td>2</td><td>3</td><td></td></tr> <tr><td>1.5</td><td></td><td></td><td></td><td>3.5</td><td></td></tr> <tr><td>2.0</td><td></td><td>2</td><td>3</td><td></td><td></td></tr> <tr><td>3.0</td><td>2</td><td>3</td><td></td><td></td><td></td></tr> <tr><td>4.0</td><td>3</td><td></td><td></td><td></td><td></td></tr> <tr><td></td><td colspan="5">Base Plate Height (BPH)</td></tr> </table>	DD	3	4	5	6	7	0.0		0		2	3	0.5					3.5	1.0	0		2	3		1.5				3.5		2.0		2	3			3.0	2	3				4.0	3						Base Plate Height (BPH)				
DD	3	4	5	6	7																																																																																																																																																																																																																																																																																																																																														
22.0					0																																																																																																																																																																																																																																																																																																																																														
21.0				0																																																																																																																																																																																																																																																																																																																																															
20.0		0		2																																																																																																																																																																																																																																																																																																																																															
19.0	0		2	3																																																																																																																																																																																																																																																																																																																																															
18.5				3.5																																																																																																																																																																																																																																																																																																																																															
18.0	0	2	3																																																																																																																																																																																																																																																																																																																																																
17.5			3.5																																																																																																																																																																																																																																																																																																																																																
17.0	2	3																																																																																																																																																																																																																																																																																																																																																	
16.5		3.5																																																																																																																																																																																																																																																																																																																																																	
16.0	2	3																																																																																																																																																																																																																																																																																																																																																	
15.5		3.5																																																																																																																																																																																																																																																																																																																																																	
15.0	3																																																																																																																																																																																																																																																																																																																																																		
14.5	3.5																																																																																																																																																																																																																																																																																																																																																		
	Base Plate Height (BPH)																																																																																																																																																																																																																																																																																																																																																		
DD	3	4	5	6	7																																																																																																																																																																																																																																																																																																																																														
19.0					0																																																																																																																																																																																																																																																																																																																																														
18.0				0																																																																																																																																																																																																																																																																																																																																															
17.0			0	2																																																																																																																																																																																																																																																																																																																																															
16.5																																																																																																																																																																																																																																																																																																																																																			
16.0	0		2	3																																																																																																																																																																																																																																																																																																																																															
15.5				3.5																																																																																																																																																																																																																																																																																																																																															
15.0	0	2	3																																																																																																																																																																																																																																																																																																																																																
14.5			3.5																																																																																																																																																																																																																																																																																																																																																
14.0	2	3																																																																																																																																																																																																																																																																																																																																																	
13.5			3.5																																																																																																																																																																																																																																																																																																																																																
13.0	2	3																																																																																																																																																																																																																																																																																																																																																	
12.5		3.5																																																																																																																																																																																																																																																																																																																																																	
12.0	3																																																																																																																																																																																																																																																																																																																																																		
11.5	3.5																																																																																																																																																																																																																																																																																																																																																		
	Base Plate Height (BPH)																																																																																																																																																																																																																																																																																																																																																		
DD	3	4	5	6	7																																																																																																																																																																																																																																																																																																																																														
12.5					0																																																																																																																																																																																																																																																																																																																																														
11.5				0																																																																																																																																																																																																																																																																																																																																															
10.5			0	2																																																																																																																																																																																																																																																																																																																																															
10.0																																																																																																																																																																																																																																																																																																																																																			
9.5	0		2	3																																																																																																																																																																																																																																																																																																																																															
9.0				3.5																																																																																																																																																																																																																																																																																																																																															
8.5	0	2	3																																																																																																																																																																																																																																																																																																																																																
8.0			3.5																																																																																																																																																																																																																																																																																																																																																
7.5	2	3																																																																																																																																																																																																																																																																																																																																																	
7.0			3.5																																																																																																																																																																																																																																																																																																																																																
6.5	2	3																																																																																																																																																																																																																																																																																																																																																	
6.0		3.5																																																																																																																																																																																																																																																																																																																																																	
5.5	3																																																																																																																																																																																																																																																																																																																																																		
5.0	3.5																																																																																																																																																																																																																																																																																																																																																		
	Base Plate Height (BPH)																																																																																																																																																																																																																																																																																																																																																		
DD	3	4	5	6	7																																																																																																																																																																																																																																																																																																																																														
0.0		0		2	3																																																																																																																																																																																																																																																																																																																																														
0.5					3.5																																																																																																																																																																																																																																																																																																																																														
1.0	0		2	3																																																																																																																																																																																																																																																																																																																																															
1.5				3.5																																																																																																																																																																																																																																																																																																																																															
2.0		2	3																																																																																																																																																																																																																																																																																																																																																
3.0	2	3																																																																																																																																																																																																																																																																																																																																																	
4.0	3																																																																																																																																																																																																																																																																																																																																																		
	Base Plate Height (BPH)																																																																																																																																																																																																																																																																																																																																																		

Minimum gaps	Reveal	With 85° angle reduction clip																																																																																																																																																																																																						
<p>The minimum gap is the gap between the closed door and the front of the cabinet.</p> <p>*only achievable with 85° angle reduction clip</p> <p>Drilling Distance (DD) table:  <table border="1"> <tr><th>DD</th><th>3</th><th>4</th><th>5</th><th>6</th><th>7</th></tr> <tr><td>24.0</td><td>1.0</td><td>1.0</td><td>1.0</td><td>1.2*</td><td>2.1*</td></tr> <tr><td>22.0</td><td>1.0</td><td>1.0</td><td>1.0</td><td>1.0</td><td>1.5*</td></tr> <tr><td>21.0</td><td>1.0</td><td>1.0</td><td>1.0</td><td>1.0</td><td>1.2*</td></tr> <tr><td>20.0</td><td>1.0</td><td>1.0</td><td>1.0</td><td>1.0</td><td>1.0</td></tr> <tr><td>19.0</td><td>1.0</td><td>1.0</td><td>1.0</td><td>1.0</td><td>1.0</td></tr> <tr><td>18.0</td><td>1.0</td><td>1.0</td><td>1.0</td><td>1.0</td><td>1.0</td></tr> <tr><td>17.0</td><td>1.0</td><td>1.0</td><td>1.0</td><td>1.0</td><td>1.0</td></tr> <tr><td>16.0</td><td>1.0</td><td>1.0</td><td>1.0</td><td>1.0</td><td>1.0</td></tr> <tr><td></td><td colspan="5">Minimum gap</td></tr> </table> </p>	DD	3	4	5	6	7	24.0	1.0	1.0	1.0	1.2*	2.1*	22.0	1.0	1.0	1.0	1.0	1.5*	21.0	1.0	1.0	1.0	1.0	1.2*	20.0	1.0	1.0	1.0	1.0	1.0	19.0	1.0	1.0	1.0	1.0	1.0	18.0	1.0	1.0	1.0	1.0	1.0	17.0	1.0	1.0	1.0	1.0	1.0	16.0	1.0	1.0	1.0	1.0	1.0		Minimum gap					<p>Reveal dimensions were determined with an edge radius (of the door) of 1mm! Hinge dimensions and reveal calculation based on factory setting.</p> <p><b>IMPORTANT</b> To determine the correct application Grass strongly recommends a trial mounting for all hinges and base plates.</p> <p>Drilling Distance (DD) table:  <table border="1"> <tr><th>DD</th><th>3</th><th>4</th><th>5</th><th>6</th><th>7</th></tr> <tr><td>24.0</td><td>2.4</td><td>2.1</td><td>2.1</td><td>2.1</td><td>2.0</td></tr> <tr><td>22.0</td><td>1.6</td><td>1.6</td><td>1.6</td><td>1.5</td><td>1.5</td></tr> <tr><td>21.0</td><td>1.4</td><td>1.3</td><td>1.3</td><td>1.3</td><td>1.3</td></tr> <tr><td>20.0</td><td>1.1</td><td>1.1</td><td>1.1</td><td>1.1</td><td>1.1</td></tr> <tr><td>19.0</td><td>0.9</td><td>0.9</td><td>0.9</td><td>0.9</td><td>0.9</td></tr> <tr><td>18.0</td><td>0.7</td><td>0.7</td><td>0.7</td><td>0.7</td><td>0.7</td></tr> <tr><td>17.0</td><td>0.6</td><td>0.6</td><td>0.6</td><td>0.6</td><td>0.6</td></tr> <tr><td>16.0</td><td>0.6</td><td>0.6</td><td>0.6</td><td>0.6</td><td>0.6</td></tr> <tr><td></td><td colspan="5">Reveal (R)</td></tr> </table> </p>	DD	3	4	5	6	7	24.0	2.4	2.1	2.1	2.1	2.0	22.0	1.6	1.6	1.6	1.5	1.5	21.0	1.4	1.3	1.3	1.3	1.3	20.0	1.1	1.1	1.1	1.1	1.1	19.0	0.9	0.9	0.9	0.9	0.9	18.0	0.7	0.7	0.7	0.7	0.7	17.0	0.6	0.6	0.6	0.6	0.6	16.0	0.6	0.6	0.6	0.6	0.6		Reveal (R)					<p>Drilling Distance (DD) table:  <table border="1"> <tr><th>DD</th><th>3</th><th>4</th><th>5</th><th>6</th><th>7</th></tr> <tr><td>36.0</td><td>11.1</td><td>10.3</td><td>9.7</td><td>9.1</td><td>8.5</td></tr> <tr><td>30.0</td><td>5.4</td><td>4.8</td><td>4.4</td><td>4.3</td><td>4.2</td></tr> <tr><td>28.0</td><td>3.7</td><td>3.6</td><td>3.5</td><td>3.4</td><td>3.3</td></tr> <tr><td>26.0</td><td>2.9</td><td>2.8</td><td>2.8</td><td>2.7</td><td>2.6</td></tr> <tr><td>24.0</td><td>2.2</td><td>2.1</td><td>2.1</td><td>2.1</td><td>2.0</td></tr> <tr><td>22.0</td><td>1.6</td><td>1.6</td><td>1.6</td><td>1.5</td><td>1.5</td></tr> <tr><td>21.0</td><td>1.4</td><td>1.3</td><td>1.3</td><td>1.3</td><td>1.3</td></tr> <tr><td>20.0</td><td>1.1</td><td>1.1</td><td>1.1</td><td>1.1</td><td>1.1</td></tr> <tr><td>19.0</td><td>0.9</td><td>0.9</td><td>0.9</td><td>0.9</td><td>0.9</td></tr> <tr><td>18.0</td><td>0.7</td><td>0.7</td><td>0.7</td><td>0.7</td><td>0.7</td></tr> <tr><td>16.0</td><td>0.6</td><td>0.6</td><td>0.6</td><td>0.6</td><td>0.6</td></tr> <tr><td></td><td colspan="5">Reveal (R)</td></tr> </table> </p>	DD	3	4	5	6	7	36.0	11.1	10.3	9.7	9.1	8.5	30.0	5.4	4.8	4.4	4.3	4.2	28.0	3.7	3.6	3.5	3.4	3.3	26.0	2.9	2.8	2.8	2.7	2.6	24.0	2.2	2.1	2.1	2.1	2.0	22.0	1.6	1.6	1.6	1.5	1.5	21.0	1.4	1.3	1.3	1.3	1.3	20.0	1.1	1.1	1.1	1.1	1.1	19.0	0.9	0.9	0.9	0.9	0.9	18.0	0.7	0.7	0.7	0.7	0.7	16.0	0.6	0.6	0.6	0.6	0.6		Reveal (R)				
DD	3	4	5	6	7																																																																																																																																																																																																			
24.0	1.0	1.0	1.0	1.2*	2.1*																																																																																																																																																																																																			
22.0	1.0	1.0	1.0	1.0	1.5*																																																																																																																																																																																																			
21.0	1.0	1.0	1.0	1.0	1.2*																																																																																																																																																																																																			
20.0	1.0	1.0	1.0	1.0	1.0																																																																																																																																																																																																			
19.0	1.0	1.0	1.0	1.0	1.0																																																																																																																																																																																																			
18.0	1.0	1.0	1.0	1.0	1.0																																																																																																																																																																																																			
17.0	1.0	1.0	1.0	1.0	1.0																																																																																																																																																																																																			
16.0	1.0	1.0	1.0	1.0	1.0																																																																																																																																																																																																			
	Minimum gap																																																																																																																																																																																																							
DD	3	4	5	6	7																																																																																																																																																																																																			
24.0	2.4	2.1	2.1	2.1	2.0																																																																																																																																																																																																			
22.0	1.6	1.6	1.6	1.5	1.5																																																																																																																																																																																																			
21.0	1.4	1.3	1.3	1.3	1.3																																																																																																																																																																																																			
20.0	1.1	1.1	1.1	1.1	1.1																																																																																																																																																																																																			
19.0	0.9	0.9	0.9	0.9	0.9																																																																																																																																																																																																			
18.0	0.7	0.7	0.7	0.7	0.7																																																																																																																																																																																																			
17.0	0.6	0.6	0.6	0.6	0.6																																																																																																																																																																																																			
16.0	0.6	0.6	0.6	0.6	0.6																																																																																																																																																																																																			
	Reveal (R)																																																																																																																																																																																																							
DD	3	4	5	6	7																																																																																																																																																																																																			
36.0	11.1	10.3	9.7	9.1	8.5																																																																																																																																																																																																			
30.0	5.4	4.8	4.4	4.3	4.2																																																																																																																																																																																																			
28.0	3.7	3.6	3.5	3.4	3.3																																																																																																																																																																																																			
26.0	2.9	2.8	2.8	2.7	2.6																																																																																																																																																																																																			
24.0	2.2	2.1	2.1	2.1	2.0																																																																																																																																																																																																			
22.0	1.6	1.6	1.6	1.5	1.5																																																																																																																																																																																																			
21.0	1.4	1.3	1.3	1.3	1.3																																																																																																																																																																																																			
20.0	1.1	1.1	1.1	1.1	1.1																																																																																																																																																																																																			
19.0	0.9	0.9	0.9	0.9	0.9																																																																																																																																																																																																			
18.0	0.7	0.7	0.7	0.7	0.7																																																																																																																																																																																																			
16.0	0.6	0.6	0.6	0.6	0.6																																																																																																																																																																																																			
	Reveal (R)																																																																																																																																																																																																							

Screw-on	Dowelled	Impresso	Cup dimensions
			<p>( ) Impresso</p>

7

# TIOMOS 120° HINGES

# GRASS







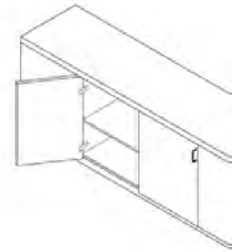

## Tiomos 120 3 Speed Soft Close 120° hinge for Standard doors

- Adjustable 3 speeds for door size and weight
- 3 dimensional door adjustment
- Allows overlays up to 24mm (15/16")
- Optimal reveal up to 24mm door thickness
- Soft-close or Self-close hinges available
- For face frame or frameless cabinets
- Convenient depth adjustment with worm gear
- 12.6mm cup bore depth



- Concealed Soft-Close

7 Pack: 150 each/Ctn.

							
<b>Full Overlay / Cranking 00</b>							
	Type	<u>Code</u>	<u>List</u>	<u>Code</u>	<u>List</u>	<u>Code</u>	<u>List</u>
	Soft Close	T28-547	\$ 8.27	T28-551	\$ 8.30	T28-369	\$ 9.95
	Self Close	-		-		T45-307	3.47
<b>Overlay / Cranking 03</b>							
	Type	<u>Code</u>	<u>List</u>	<u>Code</u>	<u>List</u>	<u>Code</u>	<u>List</u>
	Soft Close	T28-548	\$ 7.11	T28-552	\$ 7.03	-	
	Self Close	T45-486	2.76	-		T45-308	\$ 4.23
<b>Half Overlay / Cranking 9.5</b>							
	Type	<u>Code</u>	<u>List</u>	<u>Code</u>	<u>List</u>		
	Soft Close	T28-549	\$ 7.59	T28-553	\$ 7.45		
	Self Close	-		-			

**Opening Angle Reduction Clip to 85°**  
 Black Plastic



<u>Code</u>	<u>Ctn</u>	<u>List/ea</u>
T72-751	50	\$ 1.29

**Hinge Arm Cover Cap**  
 Steel, Nickel Plated



<u>Code</u>	<u>Ctn</u>	<u>List/ea</u>
T72-500	1000	\$ .59

**Wood Screw, Nickel Plated**  
 #6 x 5/8" FHP, NI



<u>Code</u>	<u>Ctn</u>	<u>List/bg</u>
81001	500/bg	\$ 36.17



**GRASS**

**TIOMOS 120° HINGES**

120° Specifications

7

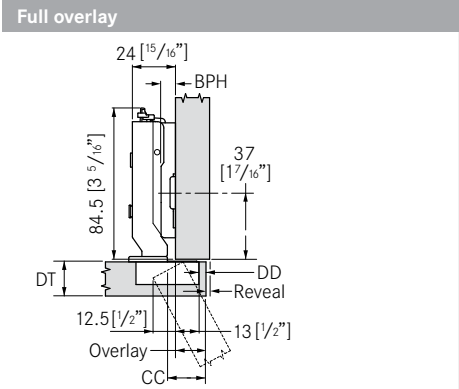

Drawing shows Tiomos with a base plate height (BPH) 02.

Drilling Distance (DD)

Door overlay max.	Drilling Distance (DD)				
	3	4	5	6	7
22.0					0
21.0				0	
20.0			0	2	
19.0	0		2	3	
18.5				3.5	
18.0	0		2	3	
17.5				3.5	
17.0	2	3			
16.5			3.5		
16.0	2	3			
15.5		3.5			
15.0	3				
14.5	3.5				
	Base Plate Height (BPH)				

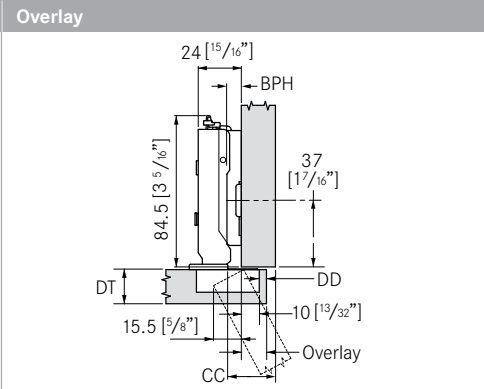

Drawing shows Tiomos with a base plate height (BPH) 02.

Drilling Distance (DD)

Door overlay max.	Drilling Distance (DD)				
	3	4	5	6	7
19.0					0
18.0				0	
17.0			0	2	
16.5					
16.0	0		2	3	
15.5				3.5	
15.0	0		2	3	
14.5				3.5	
14.0	2	3			
13.5			3.5		
13.0	2	3			
12.5		3.5			
12.0	3				
11.5	3.5				
	Base Plate Height (BPH)				

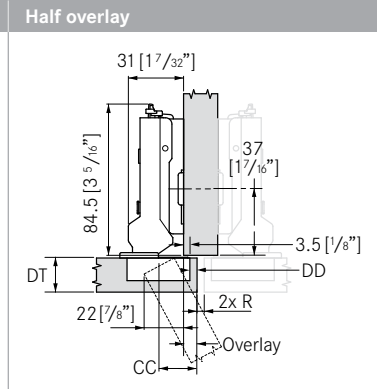

Drawing shows Tiomos with a base plate height (BPH) 02.

Drilling Distance (DD)

Door overlay max.	Drilling Distance (DD)				
	3	4	5	6	7
12.5					0
11.5				0	
10.5			0	2	
10.0					
9.5	0		2	3	
9.0				3.5	
8.5	0		2	3	
8.0				3.5	
7.5	2	3			
7.0		3.5			
6.5	2	3			
6.0		3.5			
5.5	3				
5.0	3.5				
	Base Plate Height (BPH)				

**Minimum gaps**

The minimum gap is the gap between the closed door and the front of the cabinet.

Door Thickness	Drilling Distance (DD)				
	3	4	5	6	7
24.0	1.2	2.1	3.0	3.9	4.7
22.0	1.0	1.1	2.0	2.9	3.8
21.0	1.0	1.0	1.6	2.4	3.3
20.0	1.0	1.0	1.1	2.0	2.9
19.0	1.0	1.0	1.0	1.5	2.4
18.0	1.0	1.0	1.0	1.0	1.9
17.0	1.0	1.0	1.0	1.0	1.5
16.0	1.0	1.0	1.0	1.0	1.0
	Minimum gap				

**Reveal**

Reveal dimensions were determined with an edge radius (of the door) of 1mm! Hinge dimensions and reveal calculation based on factory setting.

**IMPORTANT** To determine the correct application Grass strongly recommends a trial mounting for all hinges and base plates.

Door Thickness	Drilling Distance (DD)				
	3	4	5	6	7
24.0	6.4	5.4	4.4	3.4	2.4
22.0	3.0	2.0	1.5	1.5	1.5
21.0	1.4	1.3	1.3	1.3	1.3
20.0	1.1	1.1	1.1	1.1	1.1
19.0	0.9	0.9	0.9	0.9	0.9
18.0	0.7	0.7	0.7	0.7	0.7
17.0	1.0	1.0	1.0	1.0	1.5
16.0	1.0	1.0	1.0	1.0	1.0
	Reveal (R)				

**With 85° angle reduction clip**

Door Thickness	Drilling Distance (DD)				
	3	4	5	6	7
36.0	11.1	10.3	9.7	9.1	8.5
30.0	5.4	4.8	4.4	4.3	4.2
28.0	3.7	3.6	3.5	3.4	3.3
26.0	2.9	2.8	2.8	2.7	2.6
24.0	2.2	2.1	2.1	2.1	2.0
22.0	1.6	1.6	1.6	1.5	1.5
21.0	1.4	1.3	1.3	1.3	1.3
20.0	1.1	1.1	1.1	1.1	1.1
19.0	0.9	0.9	0.9	0.9	0.9
18.0	0.7	0.7	0.7	0.7	0.7
16.0	0.6	0.6	0.6	0.6	0.6
	Reveal (R)				

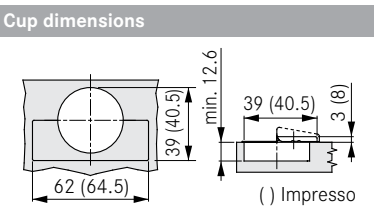
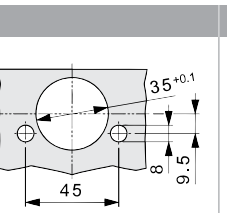
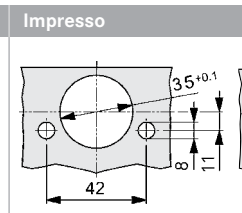
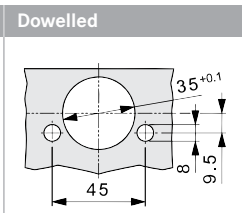
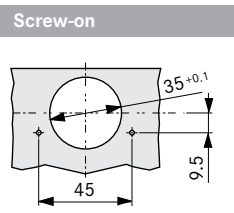



# TIOMOS 160° HINGES

**GRASS**

## Tiomos 160 3 Speed Soft Close 160° Wide angle hinge









- Concealed Soft-Close
- 10mm cup bore depth

- Adjustable 3 speeds for door size and weight
- 3 dimensional door adjustment
- Allows overlays up to 25.4mm (1")
- Soft-close or Self-close hinges available
- For face frame or frameless cabinets
- Zero protrusion when door is opened 90°
- Convenient depth adjustment with worm gear
- For door thicknesses up to 32mm (1-1/4")
- Minimum reveal

7

Pack: 50 each/Ctn.

																								
<b>Full Overlay / Cranking 00</b>	Screw-On / 45	Dowelled / 45	Dowelled / 42																					
 Hinge cup: zinc, nickel plated  Hinge arm: steel/ zinc, nickel plated	<table border="0"> <tr> <td><u>Type</u></td> <td><u>Code</u></td> <td><u>List</u></td> </tr> <tr> <td>Soft Close</td> <td>T28-561</td> <td>\$ 14.79</td> </tr> </table>	<u>Type</u>	<u>Code</u>	<u>List</u>	Soft Close	T28-561	\$ 14.79	<table border="0"> <tr> <td><u>Code</u></td> <td><u>List</u></td> </tr> <tr> <td>T28-564</td> <td>\$ 13.57</td> </tr> <tr> <td>T45-502</td> <td>11.96</td> </tr> </table>	<u>Code</u>	<u>List</u>	T28-564	\$ 13.57	T45-502	11.96										
<u>Type</u>	<u>Code</u>	<u>List</u>																						
Soft Close	T28-561	\$ 14.79																						
<u>Code</u>	<u>List</u>																							
T28-564	\$ 13.57																							
T45-502	11.96																							
<b>Overlay / Cranking 03</b>																								
 Hinge cup: zinc, nickel plated  Hinge arm: steel/ zinc, nickel plated	<table border="0"> <tr> <td><u>Type</u></td> <td><u>Code</u></td> <td><u>List</u></td> </tr> <tr> <td>Soft Close</td> <td>T28-562</td> <td>\$ 14.39</td> </tr> <tr> <td>Self Close</td> <td>T45-500*</td> <td>6.81</td> </tr> </table>	<u>Type</u>	<u>Code</u>	<u>List</u>	Soft Close	T28-562	\$ 14.39	Self Close	T45-500*	6.81	<table border="0"> <tr> <td><u>Code</u></td> <td><u>List</u></td> </tr> <tr> <td>T28-565</td> <td>\$ 16.07</td> </tr> <tr> <td>T45-503</td> <td>6.84</td> </tr> </table>	<u>Code</u>	<u>List</u>	T28-565	\$ 16.07	T45-503	6.84	<table border="0"> <tr> <td><u>Code</u></td> <td><u>List</u></td> </tr> <tr> <td>T28-383</td> <td>\$ 13.16</td> </tr> <tr> <td>T45-321</td> <td>9.06</td> </tr> </table>	<u>Code</u>	<u>List</u>	T28-383	\$ 13.16	T45-321	9.06
<u>Type</u>	<u>Code</u>	<u>List</u>																						
Soft Close	T28-562	\$ 14.39																						
Self Close	T45-500*	6.81																						
<u>Code</u>	<u>List</u>																							
T28-565	\$ 16.07																							
T45-503	6.84																							
<u>Code</u>	<u>List</u>																							
T28-383	\$ 13.16																							
T45-321	9.06																							
<b>Half Overlay / Cranking 9.5</b>																								
 Hinge cup: zinc, nickel plated  Hinge arm: steel/ zinc, nickel plated	<table border="0"> <tr> <td><u>Type</u></td> <td><u>Code</u></td> <td><u>List</u></td> </tr> <tr> <td>Soft Close</td> <td>T28-563</td> <td>\$ 13.35</td> </tr> <tr> <td>Self Close</td> <td>T45-501</td> <td>10.27</td> </tr> </table>	<u>Type</u>	<u>Code</u>	<u>List</u>	Soft Close	T28-563	\$ 13.35	Self Close	T45-501	10.27	<table border="0"> <tr> <td><u>Code</u></td> <td><u>List</u></td> </tr> <tr> <td>T28-566</td> <td>\$ 12.02</td> </tr> <tr> <td>-</td> <td></td> </tr> </table>	<u>Code</u>	<u>List</u>	T28-566	\$ 12.02	-		<table border="0"> <tr> <td><u>Code</u></td> <td><u>List</u></td> </tr> <tr> <td>T28-384</td> <td>\$ 11.94</td> </tr> <tr> <td>-</td> <td></td> </tr> </table>	<u>Code</u>	<u>List</u>	T28-384	\$ 11.94	-	
<u>Type</u>	<u>Code</u>	<u>List</u>																						
Soft Close	T28-563	\$ 13.35																						
Self Close	T45-501	10.27																						
<u>Code</u>	<u>List</u>																							
T28-566	\$ 12.02																							
-																								
<u>Code</u>	<u>List</u>																							
T28-384	\$ 11.94																							
-																								

### Wood Screw, Nickel Plated

#6 x 5/8" FHP, NI



<u>Code</u>	<u>Ctn</u>	<u>List/bg</u>
81001	500/bg	\$ 36.17

### Mitered corner application

Opening angle reduction to 120°. Prevents doors from bumping with the cabinet side in inset applications and mitered corner applications.

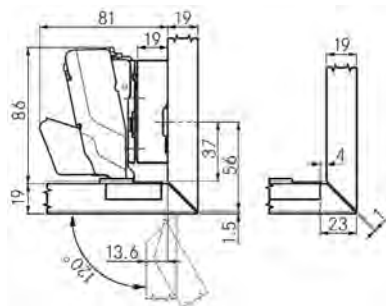

### Zero door protrusion at 90°

Zero protrusion for application with inset drawers. With 00 cranking and 00 height of base plate the door is flush with the cabinet at 90°.

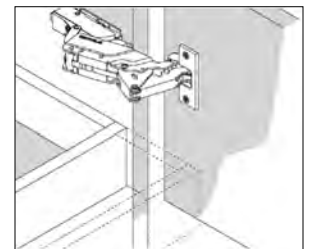

**GRASS**

**TIOMOS 160° HINGES**

160° Specifications

Full overlay	Overlay	Half overlay	Inset																																																																																																																																																																																																																																																																																																																																																																																																																																																																																																																																													
<p><b>Drilling Distance (DD)</b></p> <table border="1"> <tr><th></th><th>3</th><th>4</th><th>5</th><th>6</th><th>7</th><th>8</th><th>9</th><th>10</th></tr> <tr><th>25.0</th><td></td><td></td><td></td><td></td><td></td><td></td><td></td><td>0</td></tr> <tr><th>24.0</th><td></td><td></td><td></td><td></td><td></td><td></td><td></td><td>0</td></tr> <tr><th>23.0</th><td></td><td></td><td></td><td></td><td></td><td>0</td><td></td><td>2</td></tr> <tr><th>22.0</th><td></td><td></td><td></td><td></td><td>0</td><td></td><td>2</td><td>3</td></tr> <tr><th>21.0</th><td></td><td></td><td>0</td><td></td><td></td><td>2</td><td></td><td>3</td></tr> <tr><th>20.0</th><td></td><td>0</td><td></td><td></td><td>2</td><td></td><td>3</td><td></td></tr> <tr><th>19.0</th><td>0</td><td></td><td>2</td><td></td><td>3</td><td></td><td></td><td></td></tr> <tr><th>18.5</th><td></td><td></td><td></td><td>3.5</td><td></td><td></td><td></td><td></td></tr> <tr><th>18.0</th><td>0</td><td></td><td>2</td><td></td><td>3</td><td></td><td></td><td></td></tr> <tr><th>17.5</th><td></td><td></td><td></td><td>3.5</td><td></td><td></td><td></td><td></td></tr> <tr><th>17.0</th><td></td><td>2</td><td></td><td>3</td><td></td><td></td><td></td><td></td></tr> <tr><th>16.5</th><td></td><td></td><td>3.5</td><td></td><td></td><td></td><td></td><td></td></tr> <tr><th>16.0</th><td>2</td><td></td><td>3</td><td></td><td></td><td></td><td></td><td></td></tr> <tr><th>15.5</th><td></td><td>3.5</td><td></td><td></td><td></td><td></td><td></td><td></td></tr> <tr><th>15.0</th><td></td><td></td><td>3</td><td></td><td></td><td></td><td></td><td></td></tr> <tr><th>14.5</th><td></td><td></td><td></td><td>3.5</td><td></td><td></td><td></td><td></td></tr> </table> <p>Door overlay max. Base Plate Height (BPH)</p>		3	4	5	6	7	8	9	10	25.0								0	24.0								0	23.0						0		2	22.0					0		2	3	21.0			0			2		3	20.0		0			2		3		19.0	0		2		3				18.5				3.5					18.0	0		2		3				17.5				3.5					17.0		2		3					16.5			3.5						16.0	2		3						15.5		3.5							15.0			3						14.5				3.5					<p><b>Drilling Distance (DD)</b></p> <table border="1"> <tr><th></th><th>3</th><th>4</th><th>5</th><th>6</th><th>7</th><th>8</th><th>9</th><th>10</th></tr> <tr><th>22.0</th><td></td><td></td><td></td><td></td><td></td><td></td><td></td><td>0</td></tr> <tr><th>21.0</th><td></td><td></td><td></td><td></td><td></td><td></td><td></td><td>0</td></tr> <tr><th>20.0</th><td></td><td></td><td></td><td></td><td></td><td>0</td><td></td><td>2</td></tr> <tr><th>19.0</th><td></td><td></td><td></td><td></td><td>0</td><td></td><td>2</td><td>3</td></tr> <tr><th>18.0</th><td></td><td></td><td>0</td><td></td><td></td><td>2</td><td></td><td>3</td></tr> <tr><th>17.0</th><td></td><td></td><td></td><td>0</td><td></td><td>2</td><td></td><td>3</td></tr> <tr><th>16.5</th><td></td><td></td><td></td><td></td><td></td><td></td><td>3.5</td><td></td></tr> <tr><th>16.0</th><td></td><td>0</td><td></td><td>2</td><td></td><td>3</td><td></td><td></td></tr> <tr><th>15.5</th><td></td><td></td><td></td><td></td><td>3.5</td><td></td><td></td><td></td></tr> <tr><th>15.0</th><td>0</td><td></td><td>2</td><td></td><td>3</td><td></td><td></td><td></td></tr> <tr><th>14.5</th><td></td><td></td><td></td><td>3.5</td><td></td><td></td><td></td><td></td></tr> <tr><th>14.0</th><td></td><td>2</td><td></td><td>3</td><td></td><td></td><td></td><td></td></tr> <tr><th>13.5</th><td></td><td></td><td>3.5</td><td></td><td></td><td></td><td></td><td></td></tr> <tr><th>13.0</th><td>2</td><td></td><td>3</td><td></td><td></td><td></td><td></td><td></td></tr> <tr><th>12.5</th><td></td><td>3.5</td><td></td><td></td><td></td><td></td><td></td><td></td></tr> <tr><th>12.0</th><td></td><td></td><td>3</td><td></td><td></td><td></td><td></td><td></td></tr> <tr><th>11.5</th><td></td><td></td><td></td><td>3.5</td><td></td><td></td><td></td><td></td></tr> </table> <p>Door overlay max. Base Plate Height (BPH)</p>		3	4	5	6	7	8	9	10	22.0								0	21.0								0	20.0						0		2	19.0					0		2	3	18.0			0			2		3	17.0				0		2		3	16.5							3.5		16.0		0		2		3			15.5					3.5				15.0	0		2		3				14.5				3.5					14.0		2		3					13.5			3.5						13.0	2		3						12.5		3.5							12.0			3						11.5				3.5					<p><b>Drilling Distance (DD)</b></p> <table border="1"> <tr><th></th><th>3</th><th>4</th><th>5</th><th>6</th><th>7</th><th>8</th><th>9</th><th>10</th></tr> <tr><th>15.5</th><td></td><td></td><td></td><td></td><td></td><td></td><td></td><td>0</td></tr> <tr><th>14.5</th><td></td><td></td><td></td><td></td><td></td><td></td><td></td><td>0</td></tr> <tr><th>13.5</th><td></td><td></td><td></td><td></td><td></td><td>0</td><td></td><td>2</td></tr> <tr><th>12.5</th><td></td><td></td><td></td><td></td><td></td><td></td><td>0</td><td>2</td></tr> <tr><th>11.5</th><td></td><td></td><td></td><td></td><td>0</td><td></td><td>2</td><td>3</td></tr> <tr><th>10.5</th><td></td><td></td><td></td><td></td><td></td><td>0</td><td>2</td><td>3</td></tr> <tr><th>10.0</th><td></td><td></td><td></td><td></td><td></td><td></td><td></td><td>3.5</td></tr> <tr><th>9.5</th><td></td><td>0</td><td></td><td>2</td><td></td><td>3</td><td></td><td></td></tr> <tr><th>9.0</th><td></td><td></td><td></td><td></td><td>3.5</td><td></td><td></td><td></td></tr> <tr><th>8.5</th><td>0</td><td></td><td>2</td><td></td><td>3</td><td></td><td></td><td></td></tr> <tr><th>8.0</th><td></td><td></td><td></td><td>3.5</td><td></td><td></td><td></td><td></td></tr> <tr><th>7.5</th><td></td><td>2</td><td></td><td>3</td><td></td><td></td><td></td><td></td></tr> <tr><th>7.0</th><td></td><td></td><td>3.5</td><td></td><td></td><td></td><td></td><td></td></tr> <tr><th>6.5</th><td>2</td><td></td><td>3</td><td></td><td></td><td></td><td></td><td></td></tr> <tr><th>6.0</th><td></td><td>3.5</td><td></td><td></td><td></td><td></td><td></td><td></td></tr> <tr><th>5.5</th><td></td><td></td><td>3</td><td></td><td></td><td></td><td></td><td></td></tr> <tr><th>5.0</th><td></td><td></td><td></td><td>3.5</td><td></td><td></td><td></td><td></td></tr> </table> <p>Door overlay max. Base Plate Height (BPH)</p>		3	4	5	6	7	8	9	10	15.5								0	14.5								0	13.5						0		2	12.5							0	2	11.5					0		2	3	10.5						0	2	3	10.0								3.5	9.5		0		2		3			9.0					3.5				8.5	0		2		3				8.0				3.5					7.5		2		3					7.0			3.5						6.5	2		3						6.0		3.5							5.5			3						5.0				3.5					<p>Drawing shows Tiomos with a cranking 03 hinge, Base Plate Height (BPH) 19              X = 38.5 + DT</p> <p><b>Drilling Distance (DD)</b></p> <table border="1"> <tr><th></th><th>3</th><th>4</th><th>5</th><th>6</th><th>7</th></tr> <tr><th>0.0</th><td></td><td></td><td></td><td></td><td>19</td></tr> <tr><th>0.5</th><td></td><td></td><td></td><td></td><td></td></tr> <tr><th>1.0</th><td></td><td></td><td></td><td></td><td>19</td></tr> <tr><th>1.5</th><td></td><td></td><td></td><td></td><td></td></tr> <tr><th>2.0</th><td></td><td></td><td></td><td></td><td>19</td></tr> <tr><th>3.0</th><td></td><td></td><td></td><td>19</td><td></td></tr> <tr><th>4.0</th><td></td><td></td><td></td><td></td><td></td></tr> </table> <p>Reveal (R) Base Plate Height (BPH)</p>		3	4	5	6	7	0.0					19	0.5						1.0					19	1.5						2.0					19	3.0				19		4.0					
	3	4	5	6	7	8	9	10																																																																																																																																																																																																																																																																																																																																																																																																																																																																																																																																								
25.0								0																																																																																																																																																																																																																																																																																																																																																																																																																																																																																																																																								
24.0								0																																																																																																																																																																																																																																																																																																																																																																																																																																																																																																																																								
23.0						0		2																																																																																																																																																																																																																																																																																																																																																																																																																																																																																																																																								
22.0					0		2	3																																																																																																																																																																																																																																																																																																																																																																																																																																																																																																																																								
21.0			0			2		3																																																																																																																																																																																																																																																																																																																																																																																																																																																																																																																																								
20.0		0			2		3																																																																																																																																																																																																																																																																																																																																																																																																																																																																																																																																									
19.0	0		2		3																																																																																																																																																																																																																																																																																																																																																																																																																																																																																																																																											
18.5				3.5																																																																																																																																																																																																																																																																																																																																																																																																																																																																																																																																												
18.0	0		2		3																																																																																																																																																																																																																																																																																																																																																																																																																																																																																																																																											
17.5				3.5																																																																																																																																																																																																																																																																																																																																																																																																																																																																																																																																												
17.0		2		3																																																																																																																																																																																																																																																																																																																																																																																																																																																																																																																																												
16.5			3.5																																																																																																																																																																																																																																																																																																																																																																																																																																																																																																																																													
16.0	2		3																																																																																																																																																																																																																																																																																																																																																																																																																																																																																																																																													
15.5		3.5																																																																																																																																																																																																																																																																																																																																																																																																																																																																																																																																														
15.0			3																																																																																																																																																																																																																																																																																																																																																																																																																																																																																																																																													
14.5				3.5																																																																																																																																																																																																																																																																																																																																																																																																																																																																																																																																												
	3	4	5	6	7	8	9	10																																																																																																																																																																																																																																																																																																																																																																																																																																																																																																																																								
22.0								0																																																																																																																																																																																																																																																																																																																																																																																																																																																																																																																																								
21.0								0																																																																																																																																																																																																																																																																																																																																																																																																																																																																																																																																								
20.0						0		2																																																																																																																																																																																																																																																																																																																																																																																																																																																																																																																																								
19.0					0		2	3																																																																																																																																																																																																																																																																																																																																																																																																																																																																																																																																								
18.0			0			2		3																																																																																																																																																																																																																																																																																																																																																																																																																																																																																																																																								
17.0				0		2		3																																																																																																																																																																																																																																																																																																																																																																																																																																																																																																																																								
16.5							3.5																																																																																																																																																																																																																																																																																																																																																																																																																																																																																																																																									
16.0		0		2		3																																																																																																																																																																																																																																																																																																																																																																																																																																																																																																																																										
15.5					3.5																																																																																																																																																																																																																																																																																																																																																																																																																																																																																																																																											
15.0	0		2		3																																																																																																																																																																																																																																																																																																																																																																																																																																																																																																																																											
14.5				3.5																																																																																																																																																																																																																																																																																																																																																																																																																																																																																																																																												
14.0		2		3																																																																																																																																																																																																																																																																																																																																																																																																																																																																																																																																												
13.5			3.5																																																																																																																																																																																																																																																																																																																																																																																																																																																																																																																																													
13.0	2		3																																																																																																																																																																																																																																																																																																																																																																																																																																																																																																																																													
12.5		3.5																																																																																																																																																																																																																																																																																																																																																																																																																																																																																																																																														
12.0			3																																																																																																																																																																																																																																																																																																																																																																																																																																																																																																																																													
11.5				3.5																																																																																																																																																																																																																																																																																																																																																																																																																																																																																																																																												
	3	4	5	6	7	8	9	10																																																																																																																																																																																																																																																																																																																																																																																																																																																																																																																																								
15.5								0																																																																																																																																																																																																																																																																																																																																																																																																																																																																																																																																								
14.5								0																																																																																																																																																																																																																																																																																																																																																																																																																																																																																																																																								
13.5						0		2																																																																																																																																																																																																																																																																																																																																																																																																																																																																																																																																								
12.5							0	2																																																																																																																																																																																																																																																																																																																																																																																																																																																																																																																																								
11.5					0		2	3																																																																																																																																																																																																																																																																																																																																																																																																																																																																																																																																								
10.5						0	2	3																																																																																																																																																																																																																																																																																																																																																																																																																																																																																																																																								
10.0								3.5																																																																																																																																																																																																																																																																																																																																																																																																																																																																																																																																								
9.5		0		2		3																																																																																																																																																																																																																																																																																																																																																																																																																																																																																																																																										
9.0					3.5																																																																																																																																																																																																																																																																																																																																																																																																																																																																																																																																											
8.5	0		2		3																																																																																																																																																																																																																																																																																																																																																																																																																																																																																																																																											
8.0				3.5																																																																																																																																																																																																																																																																																																																																																																																																																																																																																																																																												
7.5		2		3																																																																																																																																																																																																																																																																																																																																																																																																																																																																																																																																												
7.0			3.5																																																																																																																																																																																																																																																																																																																																																																																																																																																																																																																																													
6.5	2		3																																																																																																																																																																																																																																																																																																																																																																																																																																																																																																																																													
6.0		3.5																																																																																																																																																																																																																																																																																																																																																																																																																																																																																																																																														
5.5			3																																																																																																																																																																																																																																																																																																																																																																																																																																																																																																																																													
5.0				3.5																																																																																																																																																																																																																																																																																																																																																																																																																																																																																																																																												
	3	4	5	6	7																																																																																																																																																																																																																																																																																																																																																																																																																																																																																																																																											
0.0					19																																																																																																																																																																																																																																																																																																																																																																																																																																																																																																																																											
0.5																																																																																																																																																																																																																																																																																																																																																																																																																																																																																																																																																
1.0					19																																																																																																																																																																																																																																																																																																																																																																																																																																																																																																																																											
1.5																																																																																																																																																																																																																																																																																																																																																																																																																																																																																																																																																
2.0					19																																																																																																																																																																																																																																																																																																																																																																																																																																																																																																																																											
3.0				19																																																																																																																																																																																																																																																																																																																																																																																																																																																																																																																																												
4.0																																																																																																																																																																																																																																																																																																																																																																																																																																																																																																																																																

**Minimum gaps**

The minimum gap is the gap between the closed door and the front of the cabinet.

\*only achievable with 120° angle reduction clip

Door Thickness	Drilling Distance (DD)								
	3	4	5	6	7	8	9	10	
32.0	1.0	1.0							
31.0	1.0	1.0	1.0						
30.0	1.0	1.0	1.0						
29.0	1.0	1.0	1.0	1.0	1.0	1.0	1.0	1.0	1.0
28.0	1.0	1.0	1.0	1.0	1.0	1.0	1.0	1.0	1.0
26.0	1.0	1.0	1.0	1.0	1.0	1.0	1.0	1.0	1.0
25.0	1.0	1.0	1.0	1.0	1.0	1.0	1.0	1.0	1.0
24.0	1.0	1.0	1.0	1.0	1.0	1.0	1.0	1.0	1.0
22.0	1.0	1.0	1.0	1.0	1.0	1.0	1.0	1.0	1.0
21.0	1.0	1.0	1.0	1.0	1.0	1.0	1.0	1.0	1.0
20.0	1.0	1.0	1.0	1.0	1.0	1.0	1.0	1.0	1.0
18.0	1.0	1.0	1.0	1.0	1.0	1.0	1.0	1.0	1.0
16.0	1.0	1.0	1.0	1.0	1.0	1.0	1.0	1.0	1.0

Minimum gap

**Reveal**

Reveal dimensions were determined with an edge radius (of the door) of 1mm! Hinge dimensions and reveal calculation based on factory setting.

**IMPORTANT** To determine the correct application Grass strongly recommends a trial mounting for all hinges and base plates.

Door Thickness	Drilling Distance (DD)								
	3	4	5	6	7	8	9	10	
32.0	0.2*	0.2*							
31.0	0.2*	0.2*	0.2*	0.2*					
30.0	0.2	0.2	0.2*	0.2*	0.2*				
29.0	0.2	0.2	0.2	0.2	0.2	0.2*	0.2*		
28.0	0.0	0.0	0.0	0.0	0.0	0.0	0.0	0.0	0.0
26.0	0.0	0.0	0.0	0.0	0.0	0.0	0.0	0.0	0.0
25.0	0.0	0.0	0.0	0.0	0.0	0.0	0.0	0.0	0.0
24.0	0.0	0.0	0.0	0.0	0.0	0.0	0.0	0.0	0.0
22.0	0.0	0.0	0.0	0.0	0.0	0.0	0.0	0.0	0.0
21.0	0.0	0.0	0.0	0.0	0.0	0.0	0.0	0.0	0.0
20.0	0.0	0.0	0.0	0.0	0.0	0.0	0.0	0.0	0.0
18.0	0.0	0.0	0.0	0.0	0.0	0.0	0.0	0.0	0.0
16.0	0.0	0.0	0.0	0.0	0.0	0.0	0.0	0.0	0.0

Reveal (R)

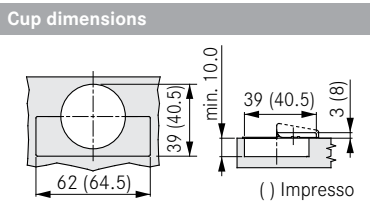
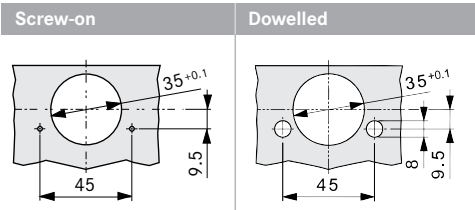



## TIOMOS CORNER HINGES

## GRASS

### 110° SOFT-CLOSE BLIND CORNER FOR OVERLAY



- For blind corner overlay construction
- 110° opening angle
- 3-D adjustment with suitable baseplate
- Convenient depth adjustment with worm gear
- Use w/ 3mm Ht euro plate

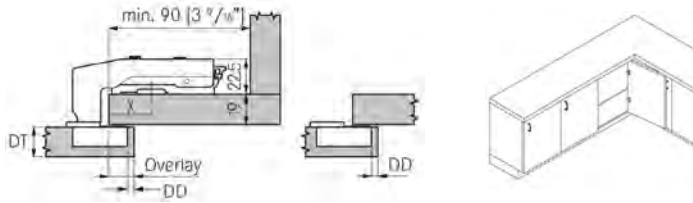

Code	Description	Ctn	List
T28-535	Overlay, Screw-on, 45mm Drill Pattern	100	\$ 14.29

### +45° ANGLE CORNER HINGE FOR OVERLAY Soft Close



- For 45° angle corner cabinets
- 110° opening angle
- 3-D adjustment with suitable baseplate
- Convenient depth adjustment with worm gear
- Use w/ 0mm plate T58-746

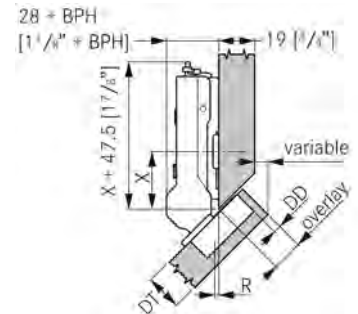
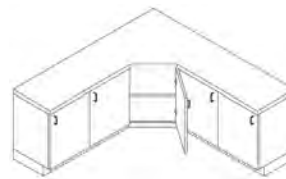

Code	Description	Ctn	List
T28-533	+45° Overlay, Screw-on, 45mm Drill Pattern	100	\$ 9.37

### 110° SOFT-CLOSE BLIND CORNER FOR INSET



- For blind corner inset construction
- 110° opening angle
- 3-D adjustment with suitable baseplate
- Convenient depth adjustment with worm gear
- Use w/ 3mm Ht euro plate

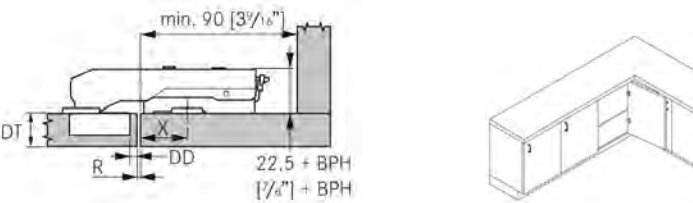

Code	Description	Ctn	List
T28-536	Inset, Screw-on, 45mm Drill Pattern	100	\$ 14.47
T28-546	Inset, Dowelled, 45mm Drill Pattern	100	12.77

### GRASS PIE-CUT CORNER HINGES

Finish: zinc alloy, nickel-plated  
Bosses recess:  $\varnothing$  35mm,  
Depth: 11mm

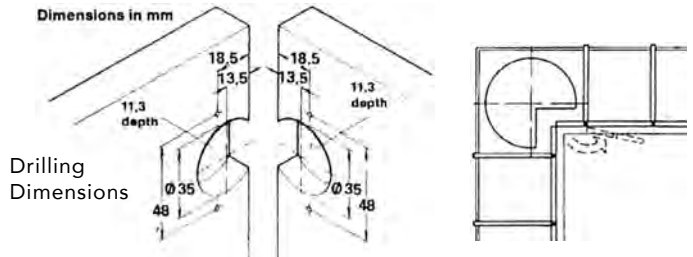

Specially designed for kitchen corner cabinets with revolving shelves. They have two identical recess bosses. Screw-mounted. Maximum door opening angle: 78°. Free-Swing. For door variable thickness from 15 - 24mm. Polybagged with 2 hinges, 1 mag. catch, 1 strike plate and instructions.

Code	Description	Ctn	List/bg
13128	Pie-Cut Corner Hinge	50 bgs	\$ 51.89



# GRASS

# TIOMOS CORNER HINGES



## Tiomos PCC Pie Cut Corner Cabinet Hinge

- 3 dimensional adjustment with suitable baseplate
- Designed for connecting two folding doors in corner cabinets
- For door thicknesses 14 to 22mm
- Self-Close hinges available
- Used in conjunction with Tiomos 160° hinges
- Use w/ 0mm Ht euro plate

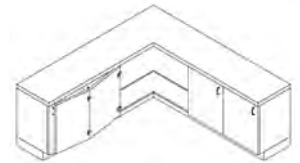

Overlay / Cranking 00 / 45mm Drilling Pattern, Screw-On

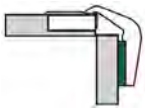

Hinge arm:  
zinc, nickel plated

Code	Description	Ctn	List
T45-517	Pie Cut hinge, Self-Close, Screw-on	150	\$ 10.31

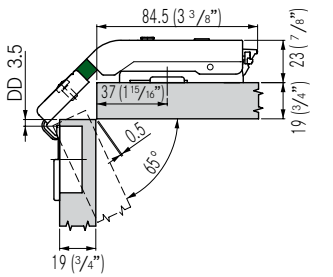

19mm door thickness with base plate height 0

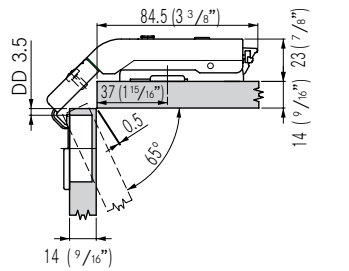

14mm door thickness with base plate height 0

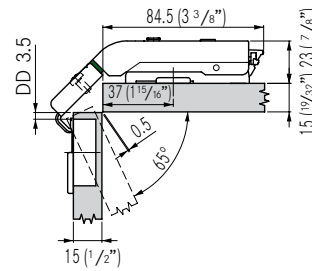

15mm door thickness with base plate height 0

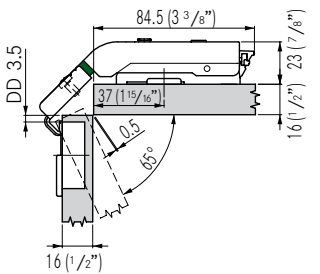

16mm door thickness with base plate height 0

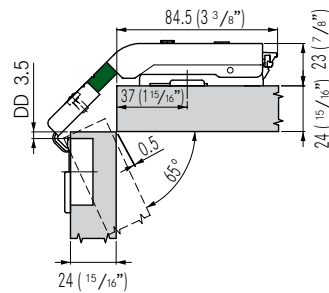

24mm door thickness with base plate height 0

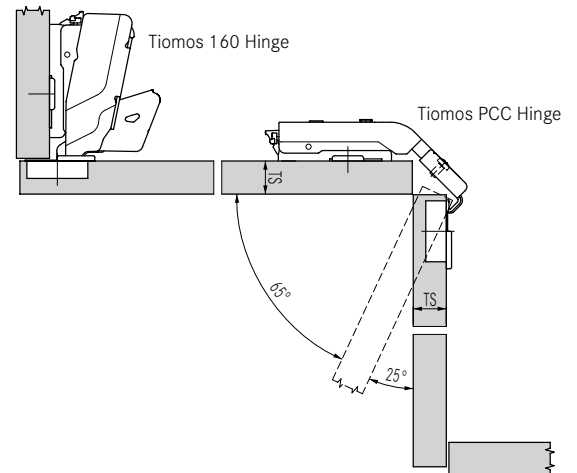

### Screw-on

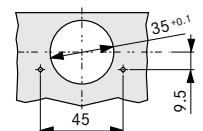

### Cup dimensions

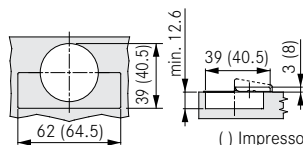

### Wood Screw, Nickel Plated

#6 x 5/8" FHP, NI



Code	Ctn	List/bg
81001	500/bg	\$ 36.17

## TIOMOS BASE PLATES

## GRASS

### TIOMOS WING BASE PLATES

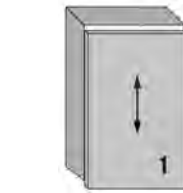
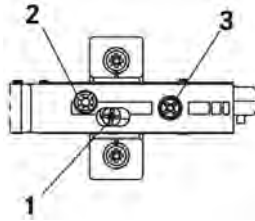

Height adjustment  
 via base plate:  
 Via worm gear: +/- 2mm  
 Via elongated holes: +/- 2.5mm



Side adjustment  
 via hinge: +/- 2mm



Depth adjustment:  
 +3 / -2mm

- Steel, nickel-plated
- Height and depth adjustment via worm gear
- Side adjustment via hinge

7

### 4 Point Fixing / 37/32 Pattern / Wood Screws



Height  
 adjustment  
 via worm gear

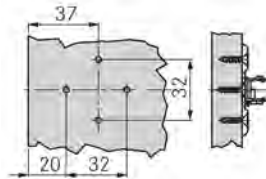

Code	Description	Ctn	List/ea
T58-746	0mm, Steel	150	\$ 1.60
T58-747	2mm	150	1.21
T58-748	3mm	150	1.30
T58-749	3.5mm	150	1.32

### 4 Point Fixing / 37/32 Pattern Pre-Mounted Euro Screws



Height  
 adjustment  
 via worm gear

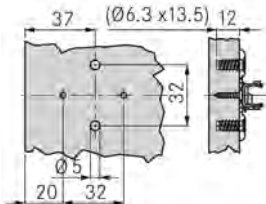

Code	Description	Ctn	List/ea
T58-761	0mm, Steel	150	\$ 1.55
T58-762	2mm	150	1.37
T58-763	3mm	150	1.60
T58-764	3.5mm	150	1.56

### With Short Euro screw for twin application

T58-865	3mm	150	\$ 2.23
---------	-----	-----	---------

### 2 Point Fixing / 37/32 Pattern / Wood Screws

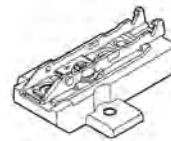

- Zinc die-cast / Steel, nickel plated
- Height adjustment via worm gear

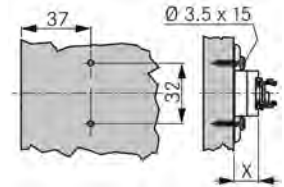

Code	Description (X)	Ctn	List/ea
T58-888	9.5mm, Screw-On	50	\$ 2.65
T58-893	12mm, Screw-On	50	3.23
T58-894	19mm, Screw-On	50	4.99

### 2 Point Fixing / 37/32 Pattern Pre-Mounted Euro Screws

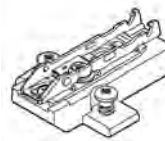

- Zinc die-cast / Steel, nickel plated
- Height adjustment via worm gear

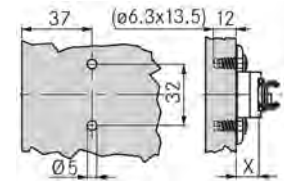

Code	Description (X)	Ctn	List/ea
T58-873	6mm	50	\$ 3.27
T58-882	9.5mm	50	3.16
T58-874	12mm	50	4.27
T58-875	19mm	50	4.75



**GRASS**

**TIOMOS BASE PLATES**

**TIOMOS FACE FRAME PLATES**

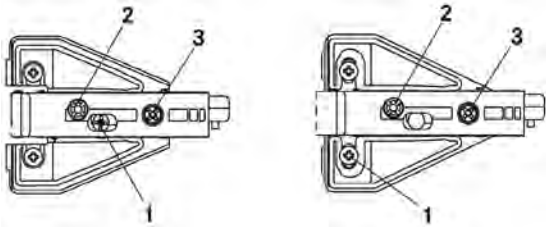

Height adjustment  
 via base plate:  
 Via worm gear: +/- 2mm  
 Via elongated holes: +/- 2.5mm



Side adjustment  
 via hinge: +/- 2mm



Depth adjustment:  
 +3 / -2mm



- Steel, nickel-plated
- Height and depth adjustment via worm gear
- Side adjustment via hinge

**2 Point Fixing / 9.5/32 Pattern / Wood Screws**



Height  
 adjustment  
 via elongated  
 screw holes

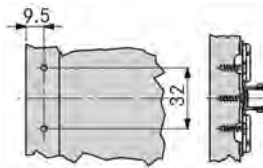

Code	Description	Ctn	List/ea
T58-821	1.5mm, Steel	150	\$ 1.51
T58-822	3.5mm	150	1.67
T58-823	4.5mm	150	1.36

**2 Point Fixing / 9.5/32 Pattern / Wood Screws**



Height  
 adjustment  
 via worm gear

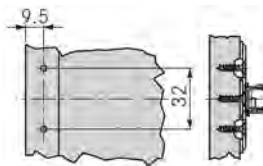

Code	Description	Ctn	List/ea
T58-825	1.5mm, Steel	150	\$ 1.89
T58-826	3.5mm	150	2.48
T58-827	4.5mm	150	2.15
T58-828	5mm	150	1.95

**Inset Face Frame Plate 3 Point Fixing  
 10/32 Pattern / Wood Screws**

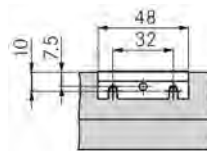

- Steel, diecast, nickel-plated
- Height adjustment via worm gear
- Requires a 9.5 crank hinge (half overlay)

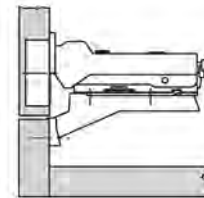
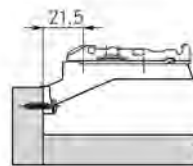

Code	Description	Ctn	List/ea
T58-831	0mm, Steel	150	\$ 3.86

**TIOMOS STRAIGHT BASE PLATE**



Height  
 adjustment  
 via worm gear

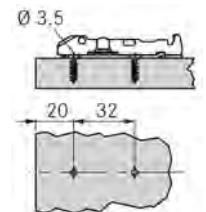

- Use a #2 Pozi drive screwdriver for hinge adjustment
- Attach base plates using all available screw holes

Code	Description	Ctn	List/ea
T59-701	0mm, Steel	150	\$ 1.98
T59-702	2mm	150	1.65



## TIOMOS ACCESSORIES

### REDUCTION CLIPS

Reduces Opening Angle to 85°

Works for all Tiomos 110° and 120° standard hinges. Reduces the opening angle to 85° to prevent doors from bumping fronts or walls in corner installations.



Black Plastic

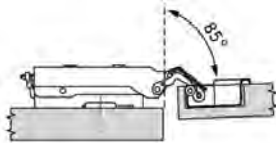
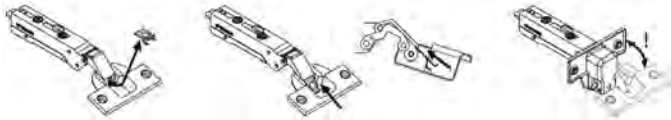

7

Code	Ctn	List/ea
T72-751	50	\$ 1.29

### GRASS EURO SCREWS

Nickel plated, for use with 6.8mm pre-drilled baseplate and 5mm system holes.

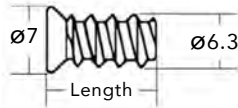

Code	Size	Ctn	List/M
81015	13mm (1/2")	500	\$ 129.93
83000	18mm (11/16")	500	165.97
83001	7.5mm (5/16")	500	112.22

### GRASS WOOD SCREWS

Phillips Flat Head screws. Nickel plated. 500/bag. One bag per carton. Sold in full bags only.

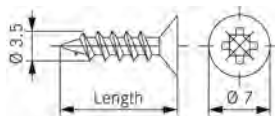

Code	Description	Bag	List/bg
81014	1/2" x 6, Phil, FH	500	\$ 32.21
81001	5/8" x 6, Phil, FH	500	36.17
81003	3/4" x 6, Phil, FH	500	35.01
81004	1" x 6, Phil, FH	500	35.28

### Dowels

Code	Description	Ctn	List/C
30179	8mm Dowel w/ screw	500 ea	\$ 43.37

## GRASS

### HINGE ARM & CUP COVER CAPS

Hinge arm for all crankings. Steel, nickel plated.



T72-500



T72-503

Code	Description	Ctn	List/ea
T72-500	Hinge Arm Cover Cap	1000	\$ .59
T72-503	Hinge Cup Cover Cap	150	1.20

### GRASS BUMPERS

Slightly Opaque



31002



31004

Must order in increments of 50 (1 sheet).  
10 sheets per Ctn (500 ea.)

Code	Ht.	Dia.	Sheet	Ctn	List/M
31002	1/8"	7/16"	50 ea.	10 sheets	\$ 124.73
31004	1/16"	7/16"	50 ea.	10 sheets	108.01

### GRASS COVER CAPS

White in color. Covers 35mm boring errors.



Code	Ctn	List/ea
22227	10	\$ .81

### HINGE HOLE REPAIR KIT

Correct drilling mistakes instead of replacing the entire door. Kit includes (2) 35mm plugs and (4) 8mm plugs. 35mm plugs are 1-1/2" thick. All plugs are tapered. Maple.



Code	Description	Ctn	List/bg
F3512SL	Hinge Hole Repair Kit	12	\$ 8.29



## GRASS

## ECOPRESS HINGE MACHINE

### GRASS ECOPRESS - Special Order

Drilling and Insertion Machine for 45mm boring pattern



- Bore depth automatically adjusts to material thickness
- Functional design
- Accurate fence is easily adjusted
- Chip removal by air on pneumatic machines
- Easy, fast and efficient operation
- Easy maintenance



**Pneumatic Control**  
Pneumatic feed and pneumatic hold-down device.



**Hold-down block**  
Optimum fixing on the Ecopress Pneumatic with the pneumatic hold-down device.



**Scale bar**  
Graduated scale for exact measurement on the machine.

Code	Motor Configuration	List/ea
F146077951299*	110v single phase pneumatic	<b>CALL</b>
F146077952299*	220v single phase pneumatic	
F146077520299*	220v three phase pneumatic	

### CARBIDE DRILL BITS FOR ECOPRESS



35mm



8mm

Code	Description	List/ea
00077-01*	35mm, RH carbide drill bit	<b>CALL</b>
00160-01*	8mm, LH carbide drill bit	
00213-01*	Bit Set: 1 x 35mm RH, 1 x 8mm LH	

### INSERTION RAMS FOR ECOPRESS

Plastic



T146-308



T146-310

Code	Description	List/ea
T146-308*	Universal Insertion die for Tiomos 110°, 120°, 160° hinge	<b>CALL</b>
T146-310*	For Tiomos 110°, 120° hinge	

### EXTENSION BARS FOR USE WITH ECOPRESS



Code	Type	From / Up to	List/ea
37535-01*	1	360mm - 1360mm	<b>CALL</b>
37536-01*	2	1360mm - 2350mm	

### PARTS NEEDED TO USE TIOMOS ON BLUM MACHINES



**Tiomos Adapter Plate**  
91366-01\* (required)



**Tiomos Insertion Ram**  
T146-310\* (required)

### ADDITIONAL STOPS FOR ECOPRESS



Code	Type	List/ea
89610-01*	Left	<b>CALL</b>
89510-01*	Right	



**Tiomos Adapter Plate & Blum Swing Arm**  
F146101318201\* (optional)

The swing arm is available but not always needed, most machines will work with just the adapter plate and insertion ram.



## BORING BITS

### HOW TO MOUNT GRASS HINGES

A trial mounting (mock-up) is advisable for every new application. Locate 1-3/8" (35mm) diameter hole on door and drill to required depth depending on hinge cup. Select hole location between 1/8" and 3/16" from front edge of door.

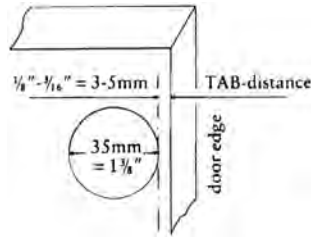

For example, if the cabinet end panel thickness is 3/4" then 3/16" is required. Press the hinge cup into the hole and secure with wood screws.

**Arm Screws**  
are dipped into a grip-lock solution which prevents screws from backing out.

Overlay and Half-Overlay

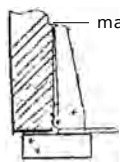

Inset

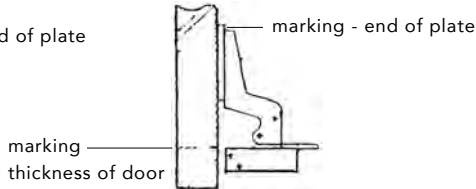

**Recommendation for initial locating of baseplates for Grass Hinges:**



To locate baseplate position slide baseplate onto a loose hinge and tighten fixing screw. Place hinge with plate as shown in the picture and mark location of baseplate. Fasten baseplate with wood screws & hinge-arm onto plate leaving approx. 1/16" gap between door and cabinet.

### CMT CARBIDE TIPPED BORING BITS

"Fatigue proof" Swiss steel body, micrograin carbide tips, bake-on non-stick coating and honed edges. Made in Italy. Negative ground spurs on boring bits give clean cuts in melamine without chipping.

#### HINGE BORING BIT

CMT

Overall Length: 57.5mm



RH	Size	List
317.260.11	26mm	\$ 47.66
317.350.11	35mm	42.08
317.400.11	40mm	64.41

### BOSCH CARBIDE TIPPED BORING BITS

Industrial Carbide Tipped.  
Shank Size: 10mm x 20mm.

Overall Length: 57mm.  
With adjustable top screw.

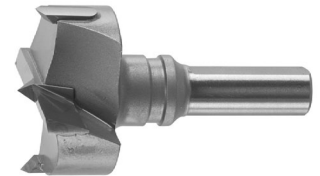

Code	Hand	Dia.	List/ea
T15040	RH	40mm	\$ 50.16

### BOSCH TWIST HINGE BORING BIT



Shank: 10 x 26mm with adjustable top screw

Boring bits for multi-spindle machines. Use on most automatic & semi-automatic boring machines. Fits almost any European boring machines.

Max. Boring Depth: 36mm. Shank: 10 x 26mm.  
Overall Length: 57mm. With adjustable top screw.  
Positive grind for hardwoods.

Code	Hand	Dia.	List/ea
T15018	LH	8mm	\$ 25.41
T15008	RH	8mm	25.42

# HETTICH

# SENSYS HINGES/PLATES

## HETTICH SENSYS HINGES AND PLATES

Clip-on hinge with concealed Soft Close - For Large or Small Doors



### 110° and 165° Hinges

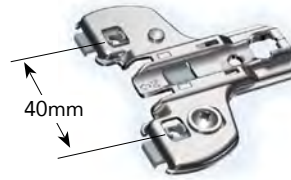

#### Face Frame plates

- Hole spacing 40 mm
- Cam height adjustment  $\pm 2$ mm
- Steel, nickel plated

- Clip on with Soft Close
- For door thickness 15 - 24 mm
- Overlay adjust + 2 mm / - 2 mm
- Depth adjust + 3 mm / - 2 mm
- Height adjust mounting plates +/- 2mm
- 20 lb/pr. rating - fewer hinges needed for oversized doors
- Made in Germany

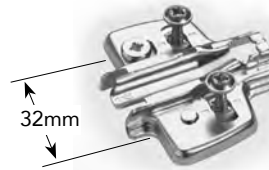

#### Frameless plates

- Hole spacing 32 mm
- Cam height adjustment  $\pm 2$ mm
- Steel, nickel plated

With Premounted Euro screws

- For  $\varnothing 5 \times 12$  mm holes

With Premounted Wood screws

- For  $\varnothing 2.5$ mm max x 12mm holes

Closes large or small doors.

No slamming doors in hot surroundings;  
no doors staying open in cold conditions:  
Soft Close range from 41° F to 104° F.

Pull-tab release to clip off.

### Restrictor Clips

Reduces opening angle of hinge from 110° to 85°.



# 9071468 List \$ .32 /ea.

### Soft Close Hinges 200/Ctn.

Code	Description	List/ea
9071223	110°, Full Overlay, Screw-On	\$ 6.92
9071226	110°, Full Overlay, Dowelled	6.96
9071238	110°, Full Overlay, Fix Fast (tool-less)	6.85
9071224	110°, Half Overlay, Screw-On	7.20
9073621	110°, Half Overlay, Dowelled	6.76
9073627	110°, Half Overlay, Fix Fast (tool-less)	9.52
9071225	110°, Inset, Screw-On	7.01
9073622	110°, Inset, Dowelled	7.25
9073628	110°, Inset, Fix Fast (tool-less)	10.53
9099561	165°, Full Overlay, Dowelled	17.08
9099563	165°, Full Overlay, Fix Fast (tool-less)	16.23
9099571	165°, Half Overlay, Dowelled	15.68
9099573	165°, Half Overlay, Fix Fast (tool-less)	16.77

### Plates 200/Ctn.

Face Frame w/ Vert Cam		List/ea
9090882	0mm, Screw-On	\$ 2.55
9090884	4.5mm, Screw-On	2.34
1135793	Inset 3mm, Screw-On	3.75
Frameless Plate		
9071665	0mm, Premounted Euro Screw	\$ 1.53
9071670	0mm, Premounted Wood Screw	1.46
9071667	3mm, Premounted Euro Screw	1.68
9071672	3mm, Premounted Wood Screw	1.56
9071668	5mm, Premounted Euro Screw	1.85
		253.14
1135743	Ram for Blum Machine	

# SENSYS HINGES



## PIE CUT CORNER HINGES

Clip-on hinge with Dowels - 50 / 65°



- Clip on Install, with Dowels
- For door thickness 16-21mm
- Cup Diameter: 35mm, Cup Depth: 12.8mm
- Made in Germany

- Diagonal adjustment: +/- 9.5mm
- Height adjust mounting plates +/- 2mm
- 20 lb/pr. - fewer hinges needed for oversized doors
- For integrated overlay and height adjustment, see specs below

### Version A - Cup drill holes in one door

- All cup drillings in one door
- Hairline reveal can be provided between door units
- No cutaway in cup holes necessary
- Same door width for both elements
- Diagonal adjustment for easy adjustment to door thickness
- Same cup distance on both sides of side mounted door
- Hole line distance of 37mm in the folding door panel
- Cup distance C 3-6mm

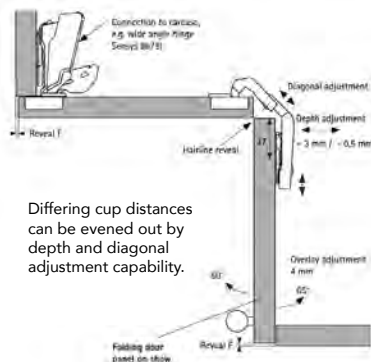

Differing cup distances can be evened out by depth and diagonal adjustment capability.

#### Calculation of door width

Door width = cabinet width - reveal F - door thickness

#### Calculation of mounting plate distance

For cup distance C = 4.5mm: Baseplate = 0mm

For cup distance C = 3.0mm: Baseplate = 1.5mm

### Version B - Cup drill holes in both doors

- Both door units are the same
- No cutaway in cup holes necessary
- Diagonal adjustment for easy adjustment to door thickness
- Hole line distance of 41mm in the side mounted door
- Cup distance C 3-6mm

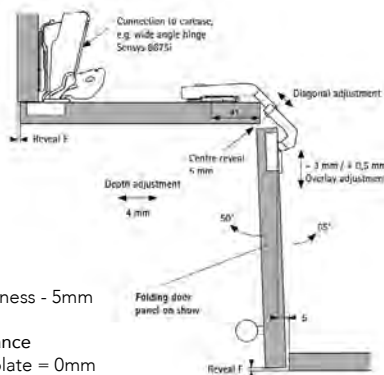

#### Calculation of door width

Door width = cabinet width - reveal F - door thickness - 5mm

#### Calculation of mounting plate distance

For cup distance C = 4.5mm: Baseplate = 0mm

For cup distance C = 3.0mm: Baseplate = 1.5mm

Pack: 50 ea/ctn

Code	Description	List/ea
9090116	Sensys Pie Cut Corner hinge	\$ 16.21

## BLIND CORNER INSET - SOFT CLOSE

95° Clip-on hinge with Dowels for Corner Cabinets



- Clip on Install, with Dowels
- For door thickness 15-28mm
- Cup Diameter: 35mm, Cup Depth: 12.8mm
- Made in Germany

- Integrated adjustment of door offset: +1mm / -2mm
- Integrated reveal adjustment +3mm / -2mm
- Height adjust mounting plates +/- 2mm
- 20 lb/pr. - fewer hinges needed for oversized doors

### Minimum reveal per door

Door thickness mm	Cup distance C mm	3.0	4.0	4.5	5.0	6.0	7.0
15	0.2	0.2	0.2	0.2	0.2	0.2	0.2
16	0.3	0.3	0.3	0.3	0.3	0.3	0.3
17	0.4	0.4	0.4	0.4	0.4	0.4	0.4
18	0.6	0.6	0.6	0.6	0.6	0.5	0.5
19	0.8	0.8	0.8	0.8	0.7	0.7	0.7
20	1.1	1.0	1.0	1.0	1.0	0.9	0.9
21	1.4	1.3	1.3	1.3	1.2	1.2	1.2
22	2.2	1.8	1.7	1.6	1.6	1.5	1.5
23	3.0	2.6	2.4	2.2	2.0	1.9	1.9
24	3.9	3.4	3.2	3.0	2.6	2.4	2.4
25	4.8	4.2	4.0	3.8	3.4	3.0	3.0
26	5.7	5.1	4.8	4.6	4.2	3.8	3.8
27	6.6	6.0	5.7	5.5	5.0	4.5	4.5
28	7.5	6.9	6.6	6.3	5.8	5.3	5.3

Please note:

The table entries refer to doors with an edge radius of 1 mm.

On doors with other radii, the minimum reveal changes as follows:

Radius 0 mm:  
 Values shown in table + 0.4 mm

Radius 3 mm:  
 Values shown in table - 0.6 mm

### Determining hole line distance X mm when using mounting plate for hole line 37

Reveal mm	Cup distance C mm	3.0	3.5	4.0	4.5	5.0	5.5	6.0	7.0
0.5	35.0	34.5	34.0	33.5	33.0	32.5	32.0	31.0	31.0
1.5	34.0	33.5	33.0	32.5	32.0	31.5	31.0	30.0	30.0
2.5	33.0	32.5	32.0	31.5	31.0	30.5	30.0	29.0	29.0
3.5	32.0	31.5	31.0	30.5	30.0	29.5	29.0	28.0	28.0
4.5	31.0	30.5	30.0	29.5	29.0	28.5	28.0	27.0	27.0
5.5	30.0	29.5	29.0	28.5	28.0	27.5	27.0	26.0	26.0
6.5	29.0	28.5	28.0	27.5	27.0	26.5	26.0	25.0	25.0
7.5	28.0	27.5	27.0	26.5	26.0	25.5	25.0	24.0	24.0

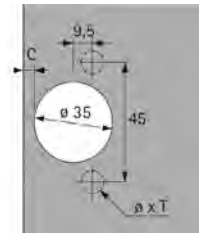

Distance D = 4mm - door offset

(recommended door offset equals 1mm)

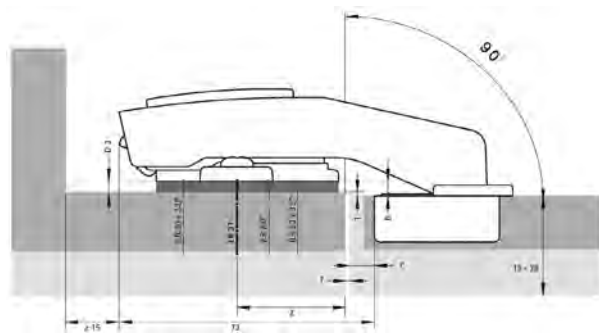

Pack: 50 ea/ctn

Code	Description	List/ea
9088045	Sensys Blind Corner Inset, Soft Close	\$ 13.96

# SUGATSUNE

# STAINLESS STEEL HINGES/PLATES

## STAINLESS STEEL CONCEALED HINGES & PLATES

### 19mm Overlay Hinge



304B-46-19  
 304B-C46-19

Code	Description	Ctn	List/ea
304B-46-19	19mm Overlay, FS	40	\$ 8.09
304B-C46-19	19mm Overlay, SC	40	8.59

F/S = Free Swinging      S/C = Self Closing

Door edge to bore edge distance (C) and Overlay distance (B)

Door edge to bore edge distance (C)	3	4	5
Overlay distance (B)	17	18	19

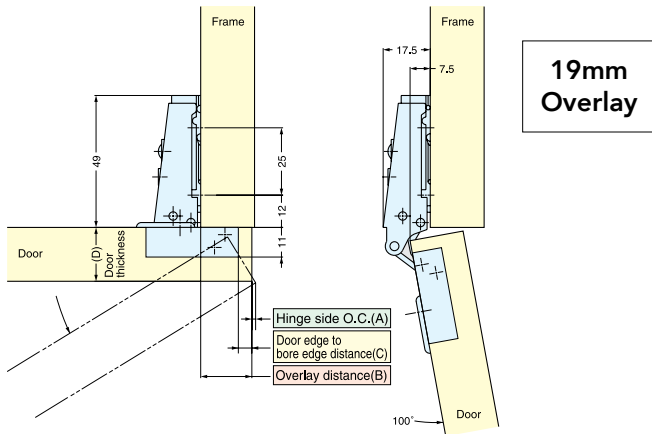

### 9mm Overlay Hinge



304B-46-9  
 304B-C46-9

Code	Description	Ctn	List/ea
304B-46-9	9mm Overlay, FS	40	\$ 8.09
304B-C46-9	9mm Overlay, SC	40	8.59

F/S = Free Swinging      S/C = Self Closing

Door edge to bore edge distance (C) and Overlay distance (B)

Door edge to bore edge distance (C)	3	4	5
Overlay distance (B)	7	8	9

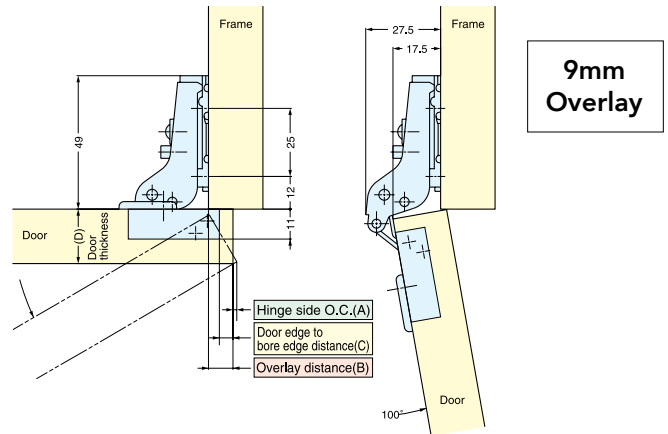

#### • Bore Dimensions

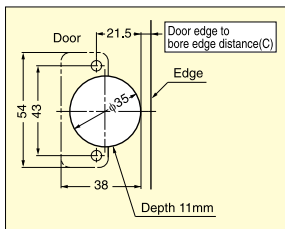

#### • Hinge side opening clearance chart

Door thickness (D)	Door edge to bore edge distance (C)		
	3	4	5
15	0.5	0.5	0.5
16	0.7	0.7	0.7
17	0.8	0.8	0.8
18	1.0	1.0	1.0
19	1.2	1.2	1.2
20	1.4	1.4	1.4
Hinge side O.C. (A)			

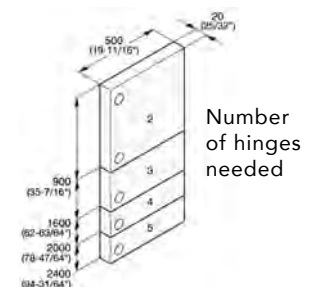

## STAINLESS STEEL BASEPLATES

304B-P4A-32-3W

Stainless Steel  
 Wing Baseplate  
 w/ elongated screw holes  
 for 3-Way adjustment

Pack: 60 ea.  
 List \$ 5.06 /ea.

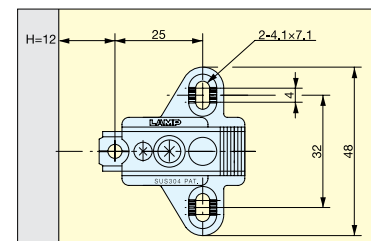



# HEAVY DUTY HINGES

# SUGATSUNE

## J95 CONCEALED HINGES / PLATES

Heavy Duty

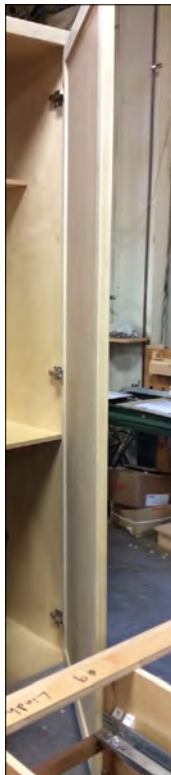

- Load capacity: **55 lbs** w/ 2 hinges, **88 lbs** w/ 3 hinges
- Doors up to **6' 6"** tall!
- Clip on type for easy installation
- 3-way adjustment with door installed
- Requires 6 x M5 or equivalent (US#10) screws:  
2 screws for each hinge, and 4 screws for each plate.
- Requires J95-P6T Mounting plate
- 40mm cup dia.



J95 hinge

J95 plate



For a single pair, the Max weight is 55 lbs. (25 kg)  
3 Hinges Max weight is 88 lbs. (42 kg)

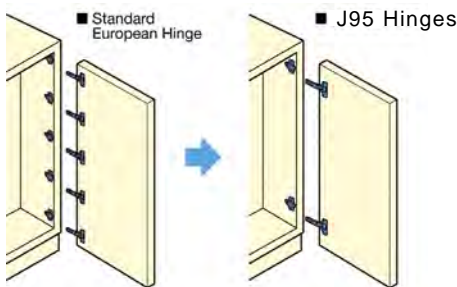

Clean look, Easy Install.

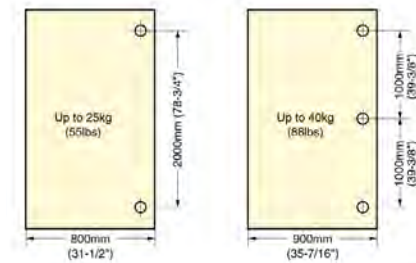

Maximum Door Specification	
Height	Thickness
2400mm (94-1/2")	30mm (1-3/16")

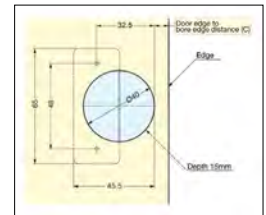
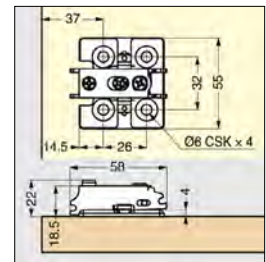

J95 Thick Door Inset Hinges used on 31" W x 93" H door.

**Overlay (20-25mm)**  
J95-C24-25T - Self Closing  
J95-24-25T - Free Swinging



**Half Overlay (16mm)**  
J95-C24-16T - Self Closing  
J95-24-16T - Free Swinging



**Inset**  
J95-C24-0T - Self Closing  
J95-24-0T - Free Swinging



**Hinge and Plate Cover Caps**



Hinge Arm Cover Cap  
Baseplate Cover Cap

- Vertical adjustment:  $\pm 3\text{mm}$  ( $\pm 1/8"$ )
- Overlay adjustment:  $+0/-4\text{mm}$  ( $\pm 5/32"$ )
- Depth adjustment:  $+1.5/-2.5\text{mm}$  ( $\pm 5/32"$ )

### Heavy Duty hinges, 40mm cup

Code	Description	List/ea
J95-C24-25T	Overlay, Self-Closing	\$ 27.30
J95-24-25T	Overlay, Free-Swinging	27.30
J95-C24-16T	Half Overlay, Self-Closing	27.30
J95-24-16T	Half Overlay, Free-Swinging	27.30
J95-C24-0T	Inset, Self-Closing	27.30
J95-24-0T	Inset, Free-Swinging	27.30

### Mounting Plate, Cover Caps, Spacer

J95-P6T	Mounting Plate, Frameless, 3-cam	\$ 10.62
J95FO-H-NI	Overlay Hinge Cover, Nickel	6.50
J95SC-25GR	Overlay Hinge Cover, Gray	3.75
J95HO-H-NI	Half Overlay Hinge Cover, Nickel	7.02
J95I-H-NI	Inset Hinge Cover, Nickel	7.02
J95-P-NI	Baseplate Cover, Nickel	10.62
J95ZC-GR	Baseplate Cover, Gray	3.34
J95-DP2	2mm Spacer	1.01



# SUGATSUNE

# HEAVY DUTY HINGES

## J95 Hinge Specifications

### Overlay (20-25mm)

J95-C24-25T - Self Closing  
 J95-24-25T - Free Swinging



■ Door edge to bore edge distance (C) and Overlay distance (E) Table 1.

Door edge to bore edge distance (C)	3	4	5	6	7	8
Overlay distance (E)	20	21	22	23	24	25

■ Hinge side opening clearance chart Table 2.

Door thickness (D)	Door edge to bore edge distance (C)					
	3	4	5	6	7	8
18	0.3	0.3	0.3	0.3	0.3	0.3
20	0.5	0.5	0.5	0.5	0.5	0.5
22	0.8	0.8	0.8	0.7	0.7	0.7
24	1.1	1.1	1.1	1.1	1.1	1.1
26	1.7	1.6	1.6	1.5	1.5	1.5
28	3.2	2.8	2.5	2.2	2.1	2.0
30	5.0	4.5	4.0	3.6	3.3	3.0
32	6.8	6.2	5.7	5.2	4.8	4.4
34	8.6	8.0	7.5	6.9	6.5	6.0

Hinge side O.C. (B)

\*Mounting Plate sold separately.  
 \*If the door thickness is over 30mm (1-3/16") the frame will need to be chamfered.

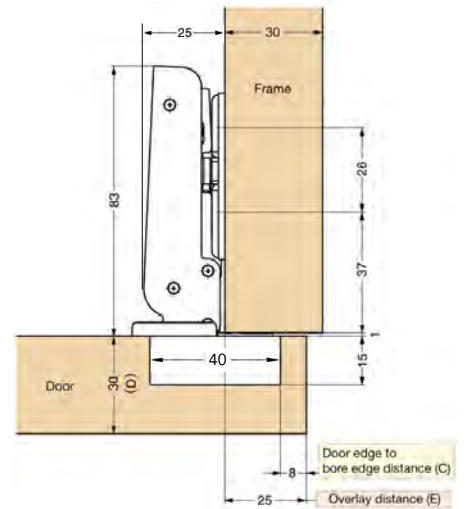

7

### Half Overlay (16mm)

J95-C24-16T - Self Closing  
 J95-24-16T - Free Swinging



■ Door edge to bore edge distance (C) and Overlay distance (E) Table 1.

Door edge to bore edge distance (C)	3	4	5	6	7	8
Overlay distance (E)	11	12	13	14	15	16

■ Hinge side opening clearance chart Table 2.

Door thickness (D)	Door edge to bore edge distance (C)					
	3	4	5	6	7	8
18	0.3	0.3	0.3	0.3	0.3	0.3
20	0.5	0.5	0.5	0.5	0.5	0.5
22	0.8	0.8	0.8	0.7	0.7	0.7
24	1.1	1.1	1.1	1.1	1.1	1.1
26	1.7	1.6	1.6	1.5	1.5	1.5
28	3.2	2.8	2.5	2.2	2.1	2.0
30	5.0	4.5	4.0	3.6	3.3	3.0
32	6.8	6.2	5.7	5.2	4.8	4.4
34	8.6	8.0	7.5	6.9	6.5	6.0

Hinge side O.C. (B)

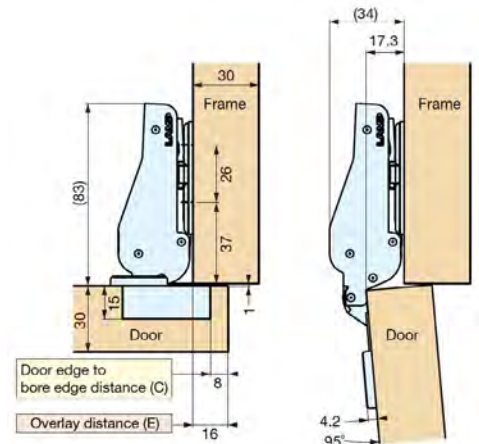

### Inset

J95-C24-0T - Self Closing  
 J95-24-0T - Free Swinging



■ Door edge to bore edge distance (C) and Hinge side O.C. (b) Table 1.

Door edge to bore edge distance (C)	3	4	5	6	7	8
Hinge side O.C. (b)	6	5	4	3	2	1

■ Hinge side opening clearance chart Table 2.

Door thickness (D)	Door edge to bore edge distance (C)					
	3	4	5	6	7	8
18	0	0	0	0	0	0
20	0	0	0	0	0	0
22	0.1	0.1	0.1	0.1	0.1	0.1
24	0.1	0.1	0.1	0.1	0.1	0.1
26	0.3	0.3	0.3	0.3	0.3	0.3
28	1.7	1.1	0.6	0.5	0.5	0.5
30	3.5	2.9	2.3	1.8	1.0	0.9
32	5.4	4.7	4.1	3.6	3.0	2.5
34	7.3	6.0	6.0	5.4	4.8	4.3

Hinge side O.C. (B)

\*If the door thickness is over 30mm (1-3/16") the door will need to be chamfered.

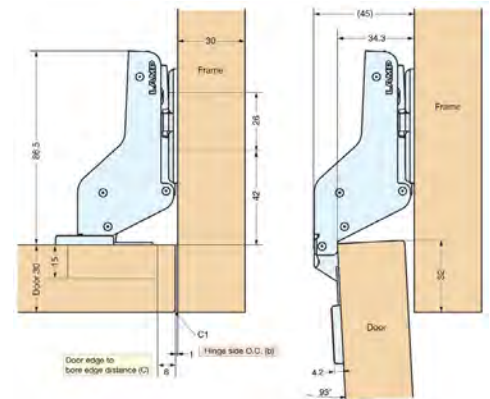



## PRIDE HINGES/PLATES

### PRIDE HINGES AND PLATES All 200 each per Ctn.



**Soft Close**

Use with below soft close plates

#### Soft Close, Cam Adj, 110°, w/ Dowels

Code	Description	List/ea
3311-8D-SC	Full Overlay, 110°, Cam adj.	\$ 5.33
3322-8D-SC	Half Overlay, 110°, Cam adj.	4.08
3333-8D-SC	Inset, 110°, Cam adj.	4.08
3390-8D-SC	Blind Corner, 110°, Cam adj.	5.22

### PRIDE HINGES AND PLATES All 200 each per Ctn.



**Self Close**

Use with below self close plates

#### Self Close, w/ Dowels

Code	Description	List/ea
HCAM634A.CL	110° Full Overlay, w/ Cam adj	\$ 2.17
634A.CL	110° Full Overlay, screw adj	1.80
634B.CL	110° Half Overlay, screw adj	2.27
H80-D-CL	Pie Corner Hinge	3.41

#### Self Close, Full Overlay, Screw-in

Code	Description	List/ea
H51A.CL	165° Self-Close, screw-in	\$ 4.50

#### **Diecast, Soft Close, Cam Adj. Face Frame Plate**



**Screw-on**  
3300CAM-SC  
3303CAM-SC

#### **Steel, Soft Close, Face Frame Plate**



**Screw-on**  
3300-SC  
3303-SC

Code	Description	List/ea
3300CAM-SC	Diecast, 0mm FF Cam Plate	\$ 2.53
3303CAM-SC	Diecast, 3mm FF Cam Plate	2.81
3300-S	Steel, 0mm Euro Plate	.64
3300-SC	Steel, 1mm FF Plate	.43
3303-SC	Steel, 3mm FF Plate	.43

#### **Diecast, Cam Self Close, Face Frame Plate**



FCLCAM.0  
FCLCAM.3

#### **Steel Face Frame Plate**



FCL.S.0  
FCL.S.3  
FCL.S.6  
FCL.S.3T

#### **Screw On Face Frame Plate - For Self Closing Hinges**

Code	Description	List/ea
FCLCAM.0	Diecast, 0mm w/ Cam, FF	\$ 1.17
FCLCAM.3	Diecast, 3mm w/ Cam, FF	.89
FCL.S.0	Steel, 0mm FF Plate	.38
FCL.S.3	Steel, 3mm FF Plate	.38
FCL.S.3T	Steel, 3mm <b>w/ Tab</b> FF Plate	.75
FCL.S.6	Steel, 6mm FF Plate	.32

#### **Diecast, Cam Adj, Soft Close Euro Plate**



**Screw-on Euro screw**  
96T00TQ 96T02TQ  
96T20TQ  
96T40TQ

Code	Description	List/ea
96T00TQ	Diecast, 0mm Cam Adj Euro Plate	\$ .81
96T20TQ	Diecast, 2mm Cam Adj Euro Plate	.55
96T40TQ	Diecast, 4mm Cam Adj Euro Plate	1.12
96T02TQ	Diecast, 0mm Cam Adj Euro Plate, w/ Euro Screw	1.92

#### **Steel Euro Plate w/ Cam Adj.**



**Screw-on Euro screw**  
T00TQ T22TQ  
T20TQ

Code	Description	List/ea
T00TQ	Steel, 0mm Cam Adj.	\$ .94
T20TQ	Steel, 2mm Cam Adj.	1.50
T22TQ	Steel, 2mm Cam Adj, w/ Euro Screw	1.00

## COMPACT HINGES

## FACE FRAME HINGES

### PRIDE COMPACT HINGES

#### Soft-Close, 100° opening

Short Arm Soft Close Face Frame CAM hinge w/ steel plate. 1/2" Overlay.



**HCAM280**

Pack: 200 each

Code	Description	List/ea
HCAM280-D-SC	1/2" Overlay, Dowelled	\$ 3.24
HCAM280-SC	1/2" Overlay, Screw-in	3.19

#### Soft-Close, 105° opening

2-Cam Adjustable, 1 pc Face Frame Hinge w/Dowels. 105° opening



**H294, H297**

Pack: 200 each

Code	Description	List/ea
H294-D-SC	1/2" Overlay, Dowelled	\$ 5.71
H297-D-SC	1-1/4" Overlay, Dowelled	3.64

### GRASS TEC872 FACE FRAME HINGE

110° Opening

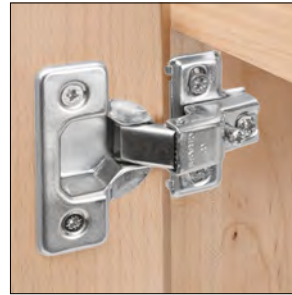

- 1/2" overlay achievable on profile door
- 3-way adjustability:  
Side: +/- 2mm,  
Depth: +2mm, Ht +/- 2mm
- All metal hinge and baseplate, nickel finish
- 45mm dowel spread

- Height adjustment in elongated screw hole
- Tight gap between door and frame
- Minimal protrusion back into cabinet
- Can drill up to 7mm tab dist. on 3/4" shaker style
- Safety catch (when one screw loosens, hinge won't fall off plate)
- A compact hinge that can allow a tab over 3mm - ok for doors with finger groove detail on edge

Door Open - Clearances

Overall Dimensions

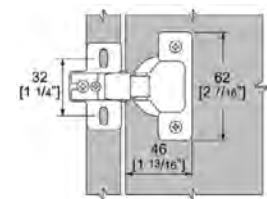
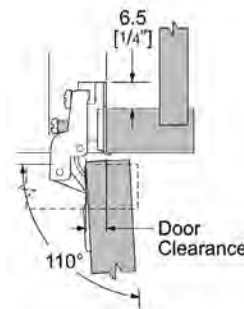

Drilling Pattern

**Fastening Screws**  
 #6 x 5/8" FHP  
 #6 x 1/2" FHP

**Baseplate Screws**  
 #6 x 5/8" FHP  
 #6 x 3/4" FHP

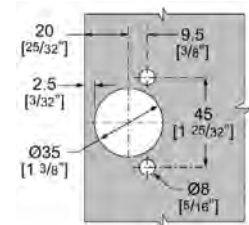

Pack: 500 ea.

Code	Description	List/ea
43729	TEC872 VS8-45 Hinge w/ dowels 45mm dowel spread-blum/salice pattern	\$ 1.37
43731	4mm Plate 872-22, 1/2" overlay	.47



# FACE FRAME HINGES



## SALICE FACE FRAME HINGES



Series S



- One Piece Hinge
- Stamped Steel, 11mm cup depth, 106° opening
- 2 and 3 way adjustments available:
  - 2-way adjustability: Depth, Side
  - 3-way adjustability: Height, Depth, Side
- One screw height adjustment
- Zero door protrusion
- K fixed at 2.5mm (3/32")
- Self-Closing  
(for Soft-Closing, see pg 780)

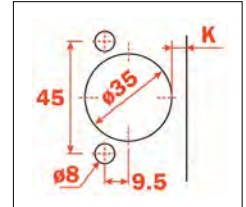

7

### 1/2" Overlay



CSR3799  
CS\_3799XR

### 5/8" Overlay

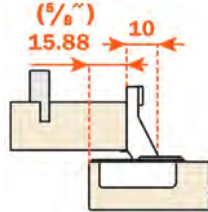

CSR3599  
CS\_3599XR

### 3/4" Overlay

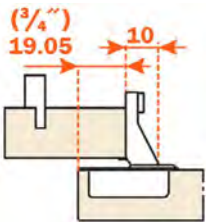

CSR3499XR

### 1" Overlay

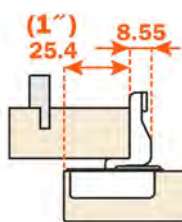

CSR3299NR

### 1-1/4" Overlay

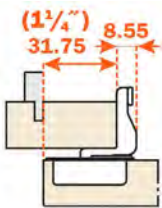

CS\_3A99N  
CSR3A99NR

### 1-3/8" Overlay

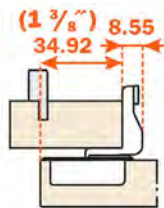

CSR3C99N  
CSR3C99NR

### 1-9/16" Overlay

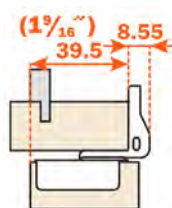

CSR3E99NR

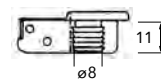
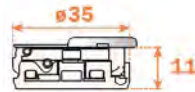

Screw-In & Dowel

**2-way adjustment** Pack: 300 ea/Ctn.



Code	Description	List
CSR3799	1/2" Overlay, Dowel	\$ 2.58
CSP3A99N	1-1/4" Overlay, Screw-in	3.40
CSR3A99N	1-1/4" Overlay, Dowel	3.33

**3-way adjustment** Pack: 300 ea/Ctn.



Code	Description	List
CSP3799XR	1/2" Overlay, Screw-in	\$ 2.57
CSR3799XR	1/2" Overlay, Dowel	3.63
CSP3599XR	5/8" Overlay, Screw-in	2.85
CSR3599XR	5/8" Overlay, Dowel	3.42
CSR3499XR	3/4" Overlay, Dowel	3.43
CSR3299NR	1" Overlay, Dowel	3.65
CSR3A99NR	1-1/4" Overlay, Dowel	3.56
CSR3C99NR	1-3/8" Overlay, Dowel	2.78
CSR3E99NR	1-9/16" Overlay, Dowel	3.57

**SALICE**

**FACE FRAME HINGES**

**SALICE SOFT-CLOSE FACE FRAME HINGES**

With Built-In Soft-Close, Adjustable Speed

**106° opening**



- For soft-closing doors with a smooth, steady motion
- Easy to use switch selects closing speed options
- Cam adjustments for perfect door alignment
- 11mm cup depth to accommodate door profiles
- Increased range of side adjustment insures small, constant gaps between doors

**Adjustable Soft Close**



Set dampening effect to 10° by sliding the switch to **O**



Set dampening effect to 40° by sliding the switch to **I**

Possible "K" = 2.5 - 6.0mm

Tab for 1-1/4" and above overlay has max of 4mm if using square edge door, 6mm if rounded edge.

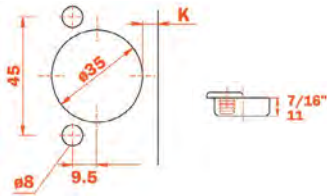

**1/2" Overlay**

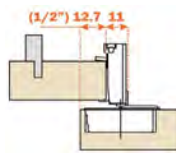

**5/8" Overlay**

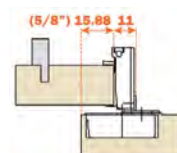

**3/4" Overlay**

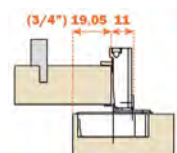

**Face Frame Reduction Clip - SUP337XG**

Reduction clip for face frame compact hinges. Limits the opening to 86°.



List/C \$

**1" Overlay**

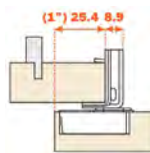

**1-1/4" Overlay**

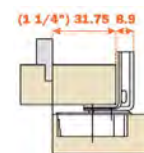

**1-3/8" Overlay**

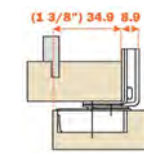

**1-9/16" Overlay**

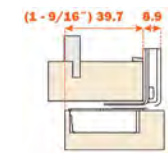

**ecocen three**



**Soft-Close, 3 Cam Adj.** Pack: 300 each

**3 Cam Adjustment: Height, Side & Depth**

**Cam Side Adjustment**



CU\_37D9R  
 -1/16" (-1.8mm) + 3/32" (+ 2.5mm)  
 CU\_3AD9R, CU\_32D9R  
 -3/32" (-2mm) + 1/8" (+ 3mm)

**Cam Height Adjustment**



+/- 3/32" (1.85mm)

**Cam Depth Adjustment**



-1/64" (-0.5mm) + 3/32" (+ 2.5mm)

Code	Description	List/ea
CUR37D9R	1/2" Overlay, Dowel	\$ 6.53
CUP37D9R	1/2" Overlay, Screw-in	5.95
CUR35D9R	5/8" Overlay, Dowel	6.27
CUR34D9R	3/4" Overlay, Dowel	6.29
CUP34D9R	3/4" Overlay, Screw-in	6.15
CUR32D9R	1" Overlay, Dowel	6.56
CUP32D9R	1" Overlay, Screw-in	5.27
CUR3AD9R	1-1/4" Overlay, Dowel	6.37
CUP3AD9R	1-1/4" Overlay, Screw-in	5.92
CUR3CD9R	1-3/8" Overlay, Dowel	6.53
CUR3ED9R	1-9/16" Overlay, Dowel	6.85

## FACE FRAME HINGES

## GRASS

### GRASS TEC864 FACE FRAME HINGE

108° Opening with  
 Cam Adjustment

- 3 dimensional adjustment
- 11mm (7/16") cup drilling depth
- Side Mount
- One piece hinge and plate combination with micro side adjustment and independent cam depth adjustment
- 45mm pattern
- Locating tabs for easy mounting on frames
- 2mm thick band arm for overlays of 1-1/4" and above
- Patented pin secures baseplate from accidental separation
- All metal construction, nickel finish
- Works on door thickness from 13mm (1/2") to 19mm (3/4")



#### Hinge Adjustment

- 1 - Side Adjustment: +/-1.5mm
- 2 - Depth Adjustment: +2.5/-0.5mm
- 3 - Height Adjustment: +/-2mm

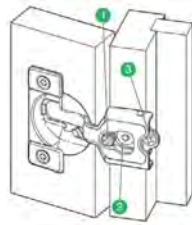

1/4" - 1"  
 Overlays

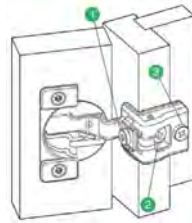

1-1/4" +  
 Overlays

Fastening Screws  
 #6 x 5/8" FHP  
 #6 x 1/2" FHP

Baseplate Screws  
 #10 x 3/4" RHP

#### Overall Dimensions

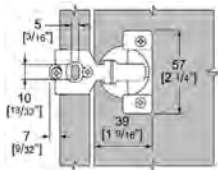

1/4" - 1"  
 Overlays

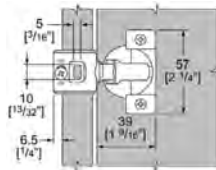

1-1/4" +  
 Overlays

#### 45mm Drilling Pattern

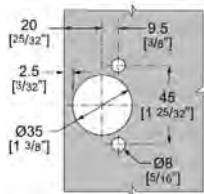

Pack: 300 ea.

Code	Description	Overlay	List/ea
03025	864VS8-45, Side Mount	1/2"	\$ 2.10
03049	864VS8-45, Side Mount	1-1/4"	2.67

### GRASS SOFT CLOSE TEC864

108° Opening with  
 Cam Adjustment

- 3 dimensional adjustment
- 11mm (7/16") cup drilling depth
- Side Mount
- Soft-close damper is premounted in the hinge cup
- Adjustment switch to regulate closing action
- One piece hinge and base plate combination
- Front locating tabs position hinge on face frame
- All metal construction, nickel finish
- Arm Clearance: 13/32"



#### Hinge Adjustment

- 1 - Side Adjust: +/-1.5mm
- 2 - Depth Adjust: +3mm
- 3 - Height Adjust: +/-2mm

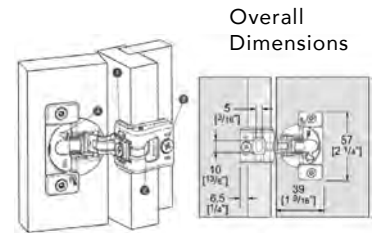

Overall  
 Dimensions

Code	Overlay	Ctn	List/ea
TEC864-VS8-114	1-1/4"	300	\$ 6.22

### GRASS SOFT CLOSE TEC863 FACE MOUNT HINGE

108° Opening

- 2 dimensional adjustment
- 11mm (7/16") cup depth
- Face Mount
- For overlays 1-7/16" or greater
- Soft Close adjustment
- One piece hinge/plate combination

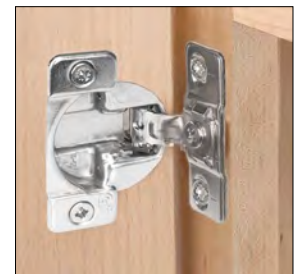

#### Hinge Adjustment

- 1 - Side Adjust: +/-1.5mm
- 2 - Height Adjust: +/-2mm (at mounting screw)
- 3 - Soft Close tension: Light, Med, and Strong setting

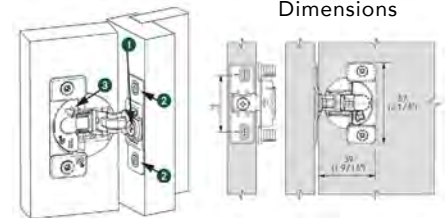

Overall  
 Dimensions

Code	Overlay	Ctn	List/ea
TEC863-VS8	1-7/16" +	300	\$ 5.80

## INSTITUTIONAL HINGES

### HETTICH SELEKTA INSTITUTIONAL HINGES

WIC Approved Grade 1 (Schools, Hospitals)



Corner hinge for single cabinet construction.  
 Opening Angle: 270°. Door Overlay: 15mm.  
 45mm Dowel Cup

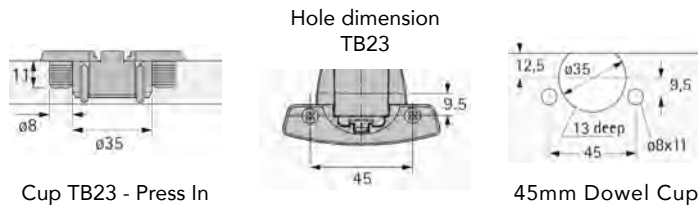

Cup TB23 - Press In

45mm Dowel Cup

- Zinc die-cast, nickel plated
- Lock can only be released with a screwdriver to protect against unintentional detachment
- Snap-on convenience - demountable
- Separate mounting of cup and hinge arm
- Overlay adjustment: -2mm  
Height adjustment: +/- 2mm
- 35mm cup at 13mm depth
- Zero protrusion at 180° open angle
- 37mm set back, 32mm line bore
- Self-closing
- Blum/Salice cup pattern in stock
- Full overlay of 3/4" end panel
- Hinge arm with premounted pan head screws

#### Mounting example

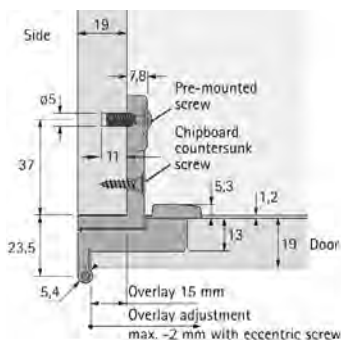

#### Easy Door Adjustments



**Overlay Adjustment**  
 Turn screw (A), the overlay can be reduced max. - 2mm  
 For easy height adjustment (+/- 2mm)  
 Turn screw (B), Then screw in the chipboard countersunk screws (C)

Code	Description	Ctn	List/ea
9022299	Hinge Arm	200	\$ 7.38
1080575	Hinge Cup	200	3.42

### SALICE INSTITUTIONAL HINGE

Single Pivot Hinge - 270° Opening - Grade 1

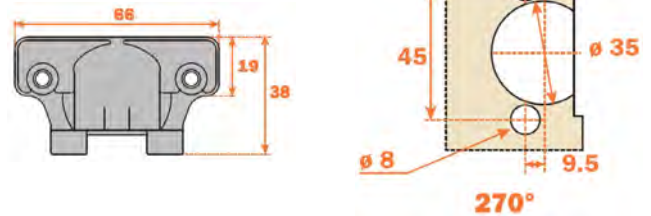

- ANSI Grade 1 certified
- Single Pivot Hinge w/ Dowels
- 270° opening angle
- Bright nickel plated die-cast cup and arm
- Sprung hinge has built-in catch
- Works with any Salice clip-on plate
- Constant gap between cabinet door and frame during overlay adjustment (exclusive to Salice)

Ideal for the most critical applications, where high stability, strength and endurance are required. They are certified for applications in public environments in conformity with ANSI Grade 1 requirements.

#### Application with external knuckle

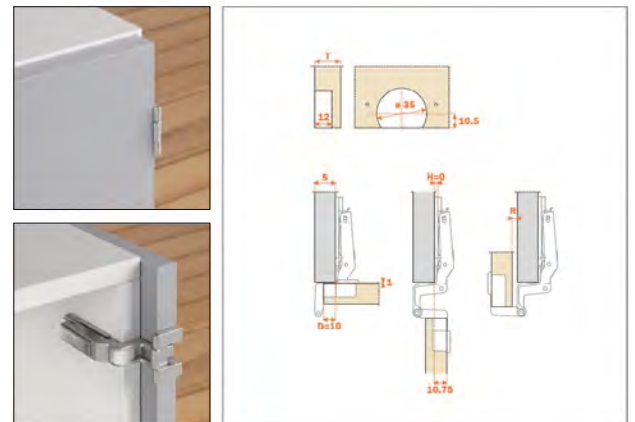

Code	Description	Ctn	List/ea
CMR3A99	Single Pivot Hinge, 270°, with Dowels	100	\$ 15.04

## INSTITUTIONAL HINGES

## SELF-CLOSING WRAP AROUND HINGES

### ROCKFORD 45/32MM HINGE

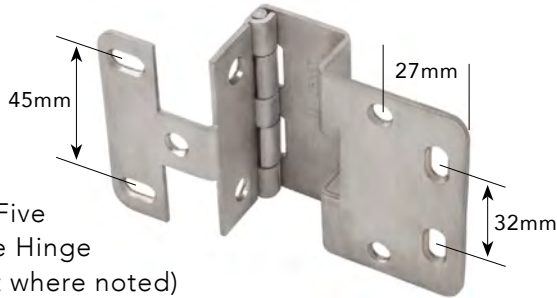

- 2-3/4" Five Knuckle Hinge (except where noted)
- .095 Steel
- Designed for 32mm Hole System
- Hospital Tips
- 45mm drill distance can be bored by standard hinge boring machine - Salice/Blum.
- 400 Series Made in USA
- Mounting holes are countersunk for #8 FH screws

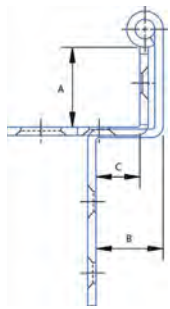

Code	Side Panel	A	B	C
454	3/4"	3/4"	23/32"	15/32"
456	3/4"	13/16"	23/32"	15/32"
74	3/4"	3/4"	23/32"	15/32"
76	3/4"	13/16"	23/32"	15/32"

Code	Finish	Door x Side	List/ea
454-26D-B	Dull Chrome	3/4" x 3/4"	\$ 6.69
456-26D-B	Dull Chrome	13/16" x 3/4"	5.53
456-1D-B	Black	13/16" x 3/4"	6.21

H08-9XG60-9A1 Dull Chrome 13/16" x 3/4" 6.72  
 (3-knuckle)

### AMEROCK SELF-CLOSING HINGES

- Easy installation
- Reliable self-closing feature when door is within 35° of cabinet frame
- Eliminates need for cabinet catches
- Two slotted holes in frame wing for vertical adj.



BPR7550

#### 1/2" Overlay

A = 1/2"

Adjustable/  
 Partial Wrap

#### Screws Included

- (4) #6 FH x 5/8"
- (6) #6 FH x 1/2"

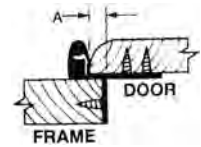

BPR7565

#### 3/8" Inset

B = 3/8"

C = 3/8"

Adjustable/Partial Wrap

#### Screws

- (4) #6 FH x 5/8"
- (6) #6 OH x 1/2"

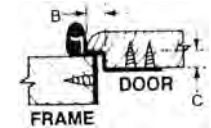

Code	Finish	Ctn	List/pr
BPR7550-W	White	25 pr.	\$ 9.99
BPR7550-G10	Satin Nickel	25	9.89
BPR7550-ORB	Oil R. Bronze	25	9.99
BPR7550-BB	Burnished Brass	25	10.98
BPR7565-G10	Satin Nickel	25	9.51
BPR7565-ORB	Oil R. Bronze	25	9.97
BPR7565-BB	Burnished Brass	25	10.99



## SELF-CLOSING HINGES

## SEMI-CONCEALED HINGES

### AMEROCK SELF-CLOSING SEMI-CONCEALED DECORATIVE HINGES

Decorative frame wings remain visible when cabinet door is closed. Compatible with Amerock cabinet hardware style groups. Easy installation. Reliable self-closing feature when cabinet door reaches 30° or less.



BPR3428

#### 3/8" Inset

B = 3/8"

C = 3/8"

#### Screws

(5) #5 OH x 5/8"

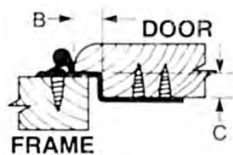

BPR3429 (25 pr)  
 CM7139 (100 pr)

#### Variable Overlay

A = Variable

#### Screws

(4) #6 OH x 5/8"

(6) #6 FH x 1/2"

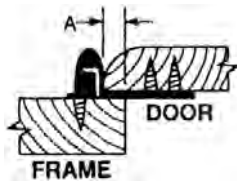

BPR7630 (25 pr)  
 CM7630 (100 pr)

#### 30° Reverse Bevel

A = Variable

#### Screws

(5) #5 OH x 5/8"

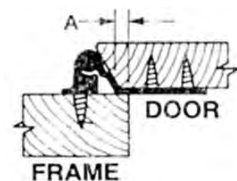

Self Closing.

Packed with screws and pads.

Code	Finish	Ctn	List/pr
BPR3428-G10	Satin Nickel	25 pr.	\$ 6.41
BPR3428-BB	Burnished Brass	25	4.82
BPR3428-26	Polished Chrome	25	5.83
BPR3428-ORB	Oil Rubbed Bronze	25	6.36
BPR3428-FB	Flat Black	25	6.43
BPR3428-W	White	25	6.36
BPR3429-G10	Satin Nickel	25	6.41
BPR3429-BB	Burnished Brass	25	5.82
BPR3429-26	Polished Chrome	25	5.78
BPR3429-ORB	Oil Rubbed Bronze	25	6.36
BPR3429-FB	Flat Black	25	8.79
BPR3429-W	White	25	6.36
CM7139-BB	Burnished Brass	100	3.76
BPR7630-26	Polished Chrome	25	10.47
BPR7630-BB	Burnished Brass	25	10.47
BPR7630-AE	Antique English	25	10.47
CM7630-BB	Burnished Brass	100	3.70

7



## AMEROCK HINGES

### SELF-CLOSING SEMI-CONCEALED DECORATIVE HINGES

Packed with screws and pads



BPR7628

#### 3/8" Inset

B = 3/8"  
C = 3/8"

Screws  
(5) #5 OH x 5/8"



BPR7928

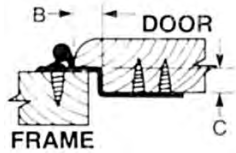

#### Variable Overlay

A = Variable

Screws  
(3) #5 FH x 1/2"  
(2) #5 OH x 5/8"



BPR7629

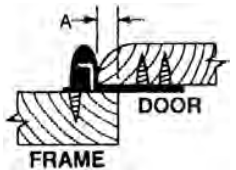

Code	Finish	Ctn	List/pr
BPR7628-26	Pol. Chrome	25 pr.	\$ 9.00
BPR7629-26	Pol. Chrome	25	9.08
BPR7928-26	Pol. Chrome	25	9.00
BPR7928-AE	Antique Brass	25	9.09

### SINGLE DEMOUNTABLE HINGES

"Wrap-Around" Self-closing - screws to frame, clamps to door



- Partial Wrap, 1/2" Overlay
- Dual-spring mechanism for quiet, consistent self-closing power
- One screw adjusts door in all 3 directions
- Uses (2) #6 F.H. X 5/8" screws

#### 1/2" Overlay

A = 1/2"

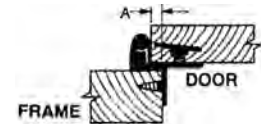

Code	Finish	Ctn	List/pr
BPR8719-G10	Satin Nickel	25 pr.	\$ 15.34
BPR8719-ORB	Oil R. Bronze	25	14.63

### DOUBLE DEMOUNTABLE HINGES

Self-Closing: Clamps to both frame & door

- Features clamping plates which clamp hinge to both the door and the frame stile
- One screw adjusts door in all 3 directions
- Heavy-duty steel construction (0.63" - 0.68")



#### 1/2" Overlay

A = 1/2"

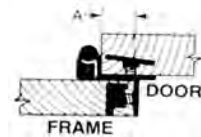

Code	Finish	Ctn	List/pr
BPR8704-BB	Burn. Brass	25 pr.	\$ 15.52
BPR8704-G10	Satin Nickel	25	15.51
BPR8704-ORB	Oil R. Bronze	25	13.97

## SEMI-CONCEALED HINGES

## INSET HINGES

### SELF-CLOSING HINGES



#### **BELWITH: OVERLAY HINGE**

Full Overlay, Self-Closing Flush Hinge. Antique Brass Finish.

Code	Ctn	List/pr
P144AB	25 pr.	\$ 6.86

### FREE-SWINGING HINGES

#### **AMEROCK SEMI-CONCEALED HINGES**

- Decorative frame wings remain visible when cabinet door is closed.
- Raised knuckle permits door to open a full 180°



BPR3417

#### **3/8" Inset**

B = 3/8"

C = 3/8"



Code	Finish	Ctn	List/pr
BPR3417-26	Pol. Chrome	25	\$ 6.41



#### **BELWITH: 3/8" INSET**

Free-Swinging.

Code	Finish	Ctn	List/pr
P140-26	Polished Chrome	25 pr.	\$ 4.71



#### **AMEROCK: FLUSH INSET**

Free-Swinging "H" Hinge. Colonial Black Finish.

Code	Ctn	List/pr
BPR3404-CB	25 pr.	\$ 6.63

### AMEROCK INSET HINGES

No Mortising Required

3175TB



A

Full Wrap Frame Wing with Ball Tip

3180TB



A

Partial Wrap Frame Wing with Ball Tip

3180TM



A

Partial Wrap Frame Wing with Minaret Tip

For a close-fitting decorative look on inset style doors without mortising. Easy horizontal/vertical adjustment. Plated steel. Screws included. Carton: 50 each.

T = 3/4" Door

**CM (Bulk Pack)** B = Ball Tip, M = Minaret Tip

Code	Finish	(A) Door Wing	List/ea
CM3180TB-DAE	Dk Ant. English	3/4"	\$ 5.41
CM3180TM-G9	Nickel	3/4"	5.41

#### **PK (Polybagged per each)**

PK3175TM-ORB	Oil R. Bronze	"	\$ 6.36
PK3175TM-AE	Ant. English	"	6.06
PK3180TB-ORB	Oil R. Bronze	"	7.06
PK3180TB-G10	Satin Nickel	"	7.00

## CABINET BUTT HINGES

### idh SOLID BRASS CABINET HINGES



82517-003      82517-014      82517-10B  
 83020-10B

Extruded solid brass cabinet hinge. Supplied with decorative threaded Ball Finials. Loose stainless steel pin.

82517: Barrel Dia: 1/4"  
 83020: Barrel Dia: 5/16"

Code	Open Size	Finishes	List/pr
82517-003	2.5" L x 1.7" W	Pol. Brass	\$ 30.40
82517-10B	2.5" L x 1.7" W	Oil R. Bronze	37.26
82517-015	2.5" L x 1.7" W	Satin Nickel	34.50
82517-014	2.5" L x 1.7" W	Pol. Nickel	44.83
83020-10B	3" L x 2" W	Oil R. Bronze	42.00

### SOLID BRASS CABINET HINGES

Eric Morris & Company



60-2015      60-2517, 60-2520

Eric Morris & Co. cabinet hinge are extruded solid brass. Supplied with decorative threaded Ball Finials. Loose stainless steel pin. Knuckle Dia: 1/4". Add Finish code upon ordering.

#### Finishes:

605 - Pol. Brass, 610 - Sat. Brass, 613 - Oil R. Bronze, 619 - Sat. Nickel, 618 - Pol. Nickel, 605NL - Pol. Brass, No Lacquer, 625 - Pol. Chrome.

Code	Open Size	List/pr
60-2015-XXX	2.0" L x 1.5" W	\$ 47.99
60-2517-XXX	2.5" L x 1.7" W	55.25
60-2520-XXX	2.5" L x 2.0" W	56.45

#### Optional Finials

Flat or Urn finials can be supplied at additional cost, 4 finials/set. One set of finials for One pair of hinges.



Code	Description	List/st
60-FF-XXX	Flat Finial	\$ 10.34
60-UF-XXX	Urn Finial	11.84

## CABINET BUTT HINGES

### NON-MORTISE ADJUSTABLE BUTT HINGE

For Easy Full Inset Door Mounting

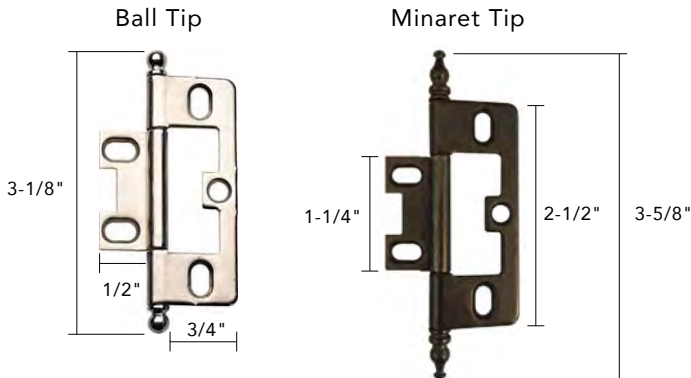

Plated Steel. Allows full inset door mounting with easy installation and adjustment. With Ball Tips or Minaret Tips. Uses (10) 5/8 x 5 flat screws per pair (not included). Polybags packed with screws. Hinge thickness approx. 5/64" or 1.5mm.

Code	Tips	Finish	List/pr
363-03	Ball	Polished Brass	\$ 6.35
906-03	Minaret	Polished Brass	6.72

### Brass Plate Screws for above hinges

Code	Description	List/C
58-5 PHFT-BP	5/8 x 5 Phil FHTS	2.26

### NON-MORTISE BUTT HINGE

Steel

3" Non-mortise Shutter Hinge w/ Loose Pin.

Recommended screw:  
 #6 FH.



Code	Finish	List/ea
H145-WT	White	\$ 2.78
AV-21533-OB	Oil R Bronze	3.30
AV-21533-NI	Nickel	3.24

### NON-MORTISE BUTT HINGE

Solid Brass



#2581

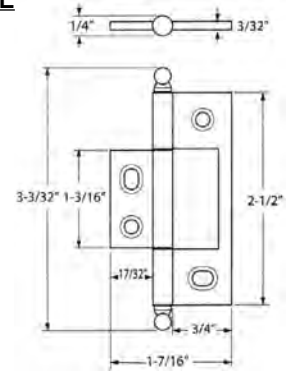

Non-Mortise, Solid Brass adjustable butt hinge with ball tips. Polybagged - one hinge/ bag with screws.

Code	Finish	List/bag
2581PN	Polished Nickel	\$ 25.49
2581SN	Satin Nickel	23.51
2581WZ	Weathered Bronze	22.58
2581BZ	Oil R Bronze	25.83

### FULLY CONCEALED HINGE "Easy Mount"

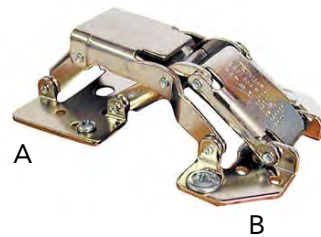

#21

"Easy Mount"

A = Door Mounting Plate  
 B = Cabinet Mounting Plate



- For doors 1/2" to 3/4" thick
- No routing required: Surface mounted
- Overlay 0" to 3/4", 3/8" and Full Inset
- 6 way adjustment
- 150° opening angle, Zero protrusion
- Self closing
- Fits cabinets with or without a face frame

Code	Description	Ctn	List/pr
21	Easy Mount Hinge	50 pr.	\$ 18.16



## OVERLAY ANGLE HINGES

## SOSS HINGES

### OVERLAY DOOR ANGLE HINGE

Sugatsune

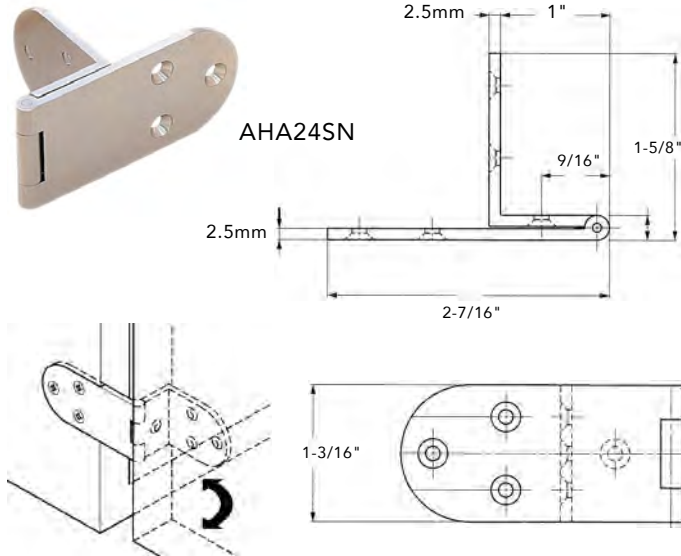

Solid Brass with Satin Nickel finish. Recommended Door Size: 17.71" W x 27.55" H x 3/4" thick. Max. Door Weight: 5.7 lbs/pair.

Code	Finish	Ctn	List/ea
AHA24SN	Sat. Nickel	10 ea.	\$ 39.23

### SOSS INVISIBLE HINGES

Invisible Barrel Hinges are made of solid brass with brass links and are easily installed. Hinges are totally invisible from either side when the door is closed, the cylinders have grooves which are inserted in cleanly drilled holes & glued into place. Tightening the tension screw provides a tight fit. Opening Angle: 180°. Wood lippings are not necessary. Not recommended for vertical or load bearing application.

**BH124**  
For 5/8" material



Dia: 12mm  
Bore Depth: 13.5mm

**BH144**  
For 3/4" material



Dia: 14mm  
Bore Depth: 15.5mm

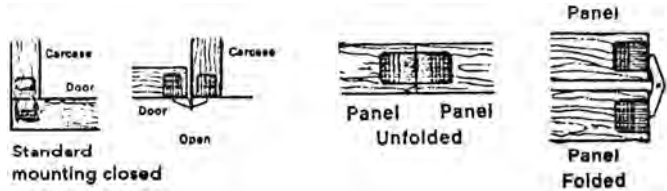

Code	Finish	Ctn	List/ea
BH124	Dull Brass	24 ea.	\$ 5.12
BH144	Dull Brass	24	5.81

## SOSS

## INVISIBLE HINGES

### SOSS INVISIBLE HINGES

Completely hidden from view when doors or lids are closed. Creates flush, smooth surfaces. Made from heavy duty rust-proof zinc alloy castings. An installing template to exact size is included w/each pair. Hinge dimensions are given for size of front plates. Dull Brass and Dull Chrome finishes available, other finishes available special order.



#### 100C Non-Load Bearing Installations

Plate size: 3/8" x 1"  
 Min. Wood thickness: 1/2"

Code	Ctn	List/pr
100C	10 pr.	\$ 25.00



#### 101C Non-Load Bearing Installations

Plate size: 3/8" x 1-11/16"  
 Min. Wood thickness: 1/2"

Code	Ctn	List/pr
101C	10 pr.	\$ 34.05

#### For Light Cabinet Doors

Min. Wood thickness: 3/4"



**103C:** Plate size: 1/2" x 1-1/2"

**203C:** Plate size: 1/2" x 1-3/4"

Code	Ctn	List/pr
103C	10 pr.	\$ 29.92
203C	10	36.88



#### 303C Non-Load Bearing Installations

Plate size: 1/2" x 1-33/64"  
 Min. Wood thickness: 11/16"

Code	Ctn	List/pr
303C	10 pr.	\$ 24.83



#### 204C For Wood/Metal Cabinets & Light Doors - 10 pr/Ctn.

Plate size: 1/2" x 2-3/8"  
 Min. Wood thickness: 3/4"

Code	Finish	List/pr
204C	Dull Brass	\$ 37.94
204CUS26D	Dull Chrome	39.47

#### 208 / For Wood/Metal Cabinets & Light Doors

Min. Wood Thickness: 1". 1 each/box.

Code	Finish	Plate Size	List/ea
208	Dull Brass	5/8" x 2-3/4"	\$ 23.37
208US26D	Dull Chrome	5/8" x 2-3/4"	23.34

#### 212 / For Medium Wood/Metal Cabinet Doors

Min. Wood Thickness: 1-1/8". 1 each/box.

212SO	Dull Brass	3/4" x 3-3/4"	\$ 43.67
212US26D	Dull Chrome	3/4" x 3-3/4"	43.58

**For Soss Hinges for Full Size Wood/Metal Doors and 'Choose the Right Hinge' Chart, see page 832.**

#### SOSS HINGE ROUTER GUIDE TEMPLATES



Installation of SOSS hinges has never been easier or faster. A perfect routed outline is foolproof, you can expect a perfect installation every time.

All List for \$ 59 ea.

Code	For Hinge	Code	For Hinge
101-IT	101	212-IT	212
103-IT	103	216-IT	216
203-IT	203	218-IT	218
204-IT	204	220-IT	220
208-IT	208		

#### Needed with SOSS Hinge Templates:

Code	Description	List/ea
42024	3/4" template guide	\$ 13.35
42237	Locknut for template guides	7.79

## CONCEALED HINGES

## SUGATSUNE

### 3-WAY ADJ. CONCEALED CABINET HINGE

HES3D-70 - Load Cap: 20 lbs/ 2 hinges

For 19mm (3/4") min Thick **Cabinet Doors**



- 3-Way Adjustment:
  - Horizontal: -1 ~ +1mm
  - Vertical: -1.5 ~ +1.5mm
  - Depth: -1.5 ~ +1.5mm
- Max Door Weight:
  - 20 lbs/ 2 hinges
  - 26.4 lbs/ 3 hinges
- Max Door Width: 600mm (23-5/8")
- Max Door Height: 1200mm (47-1/4")
- Min Door Thickness: 19mm (3/4")
- Cover hides all screw heads for clean appearance

#### Dimensions

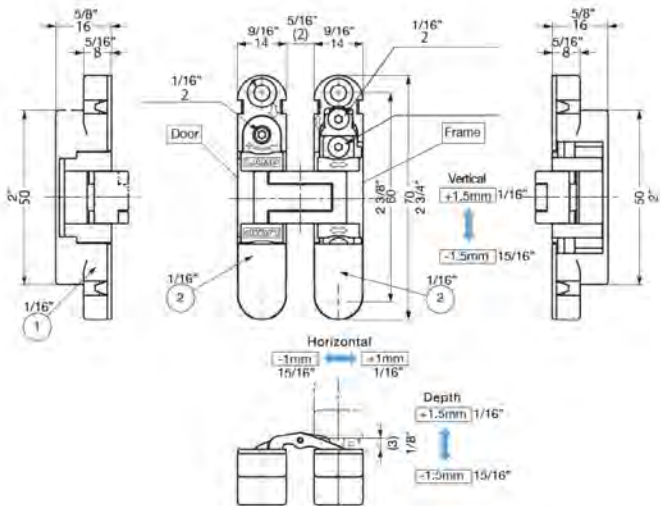

Code	Finish	List/ea
HES3D-70-DC	Satin Chrome	\$ 52.57
HES3D-70-DN	Satin Nickel	52.57
HES3D-70-BL	Black	52.57

### 3-WAY ADJ. CONCEALED CABINET HINGE

HES3D-90 - Load Cap: 26 lbs/ 2 hinges

For 23mm (7/8") min Thick **Cabinet Doors**



HES3D-90-BL

- 3-Way Adjustment:
  - Horizontal: -1.5 ~ +1.5mm
  - Vertical: -1.5 ~ +1.5mm
  - Depth: -1 ~ +1mm
- Max Door Weight:
  - 26 lbs/ 2 hinges
  - 35 lbs/ 3 hinges
- Opening Angle: 180°
- Easy Installation

- Min Door Thickness: 23mm (7/8")
- Stocking black finish - other finishes avail. special order
- Cover hides all screw heads for clean appearance

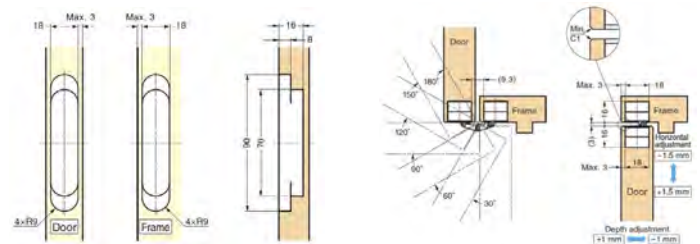
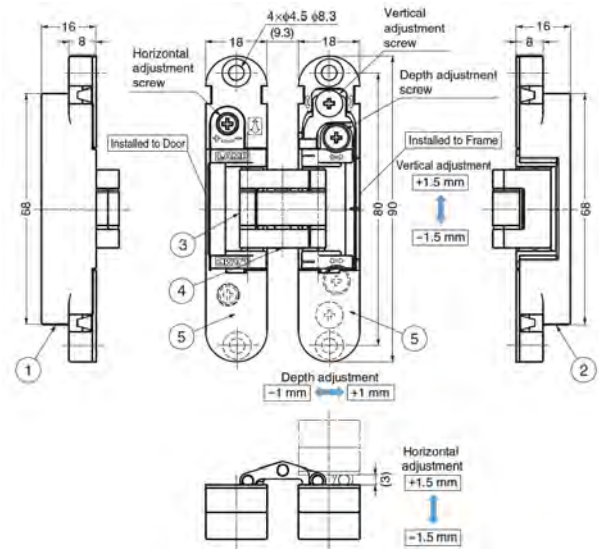

Code	Finish	List/ea
HES3D-90-BL	Black	\$ 71.78





## CONTINUOUS HINGES

### CONTINUOUS HINGES



#### STANLEY

Steel Continuous Hinges. Polybagged w/ screws.

#### Nickel Finish

Code	Open Width	Length	Ctn	List/ea
70-1470	1-1/2"	30"	5	\$ 20.92
47-1640	1-1/2"	48"	5	28.22



#### PIANO HINGES (Larsen & Shaw)

Steel Continuous Hinges. Polybagged w/ screws.

#### Nickel Finish

Code	Open Width	Length	Ctn	List/ea
6-1.5NP-P	1-1/2"	6'	25	\$ 33.62

#### Polished Brass Finish

Code	Open Width	Length	Ctn	List/ea
6-1.5BP-P	1-1/2"	6'	25	\$ 59.16

#### PIANO HINGES (Larsen & Shaw)

Continuous Hinges. Screws not included.

#### Brass Plate on Steel

Code	Open Width	Length	Ctn	List/ea
6-1116BP	1-1/16"	6'	25	\$ 9.08
6-1.25BP	1-1/4"	6'	25	22.16
6-1.5BP	1-1/2"	6'	25	22.86
6-2BP	2"	6'	20	14.56

#### Nickel Plate on Steel

6-1116NP	1-1/16"	6'	25	\$ 17.35
6-1.25NP	1-1/4"	6'	25	21.75
6-1.5NP	1-1/2"	6'	25	23.11
6-2NP	2"	6'	20	36.41

#### Statuary (Dark) Bronze

6-1.5STB	1-1/2"	6'	25	\$ 41.91
----------	--------	----	----	----------

#### Aluminum

6-1.5AL	1-1/2"	6'	50	\$ 25.60
6-2AL	2"	6'	25	16.62

#### PIANO HINGES (Larsen & Shaw)

Continuous Hinges. Screws not included.

#### Brass Plate on Steel

Code	Open Width	Length	Ctn	List/ea
7-212BP	2-1/2"	7'	20	\$ 56.86
7-3BP	3"	7'	15	55.85

#### Nickel Plate on Steel

7-212NP	2-1/2"	7'	20	\$ 52.57
7-3NP	3"	7'	15	71.69

## GLASS DOOR HINGES

### WOODEN DOOR PIVOT HINGE

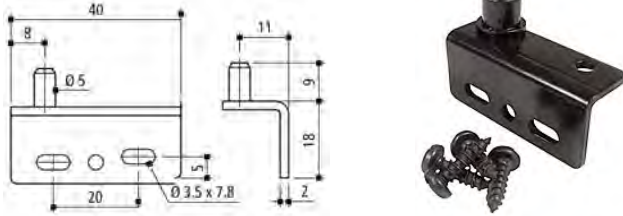

"Simplex" wooden door pivot hinge. For wooden doors from 14mm (9/16") to 19mm (3/4"). Offers the manufacturer of audio-furniture the flexibility of using wood or glass doors on the same unit, as the plastic bushing is the same as on the glass simplex. 1 pair consists of 2 hinge parts, 2 plastic bushings and 4 screws. For inset application.

Code	Finish	Ctn	List/pr
FT21641	Black	10 pr.	\$ 2.24

### NON-BORE GLASS DOOR HINGES

Non-bore glass door hinges are designed to match the technical look of stereo components and cabinets. As they do not require any drilling on the glass, they help to reduce production costs.

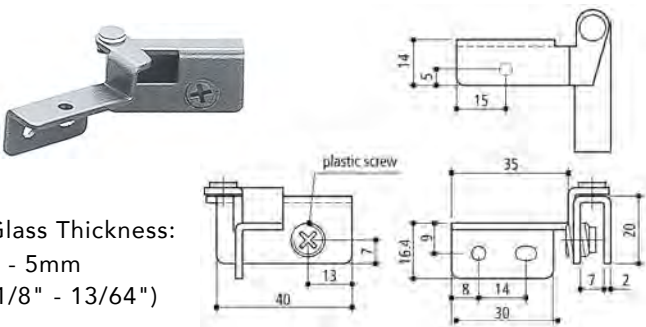

Glass Thickness:  
 3 - 5mm  
 (1/8" - 13/64")

Overlay glass door hinge for glass thickness from 3mm to 5mm. 1 pair consists of two hinge parts with attaching mounting bracket & 2 plastic set screws. Mounting instructions: Drill according to diagram.

Code	Finish	Ctn	List/pr
21770CH	Chrome	50 pr.	\$ 4.28

### INSET GLASS DOOR HINGE

Sugatsune

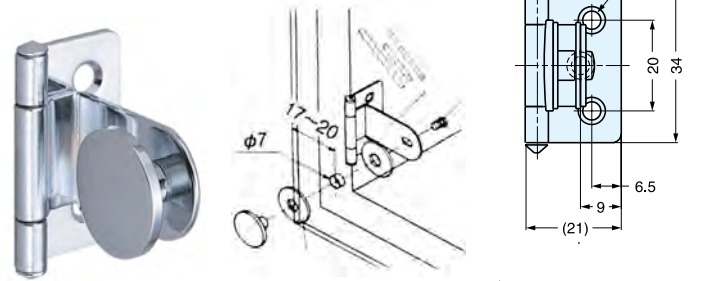

Inset Glass Door Hinge available in 18-8 Stainless Steel or Chrome.

Glass Thickness: 5/32" to 15/64"  
 Door weight max 8.8 lbs/pr.

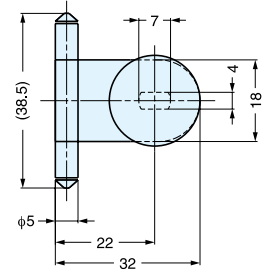

Code	Finish	Ctn	List/ea
GH34-OSS	Stainless Steel	10	\$ 8.69
GH34-OCR	Chrome	10	7.58

### HALF OVERLAY GLASS DOOR HINGE

Sugatsune

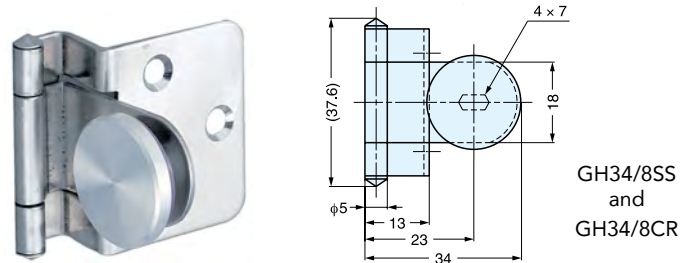

GH34/8SS  
 and  
 GH34/8CR

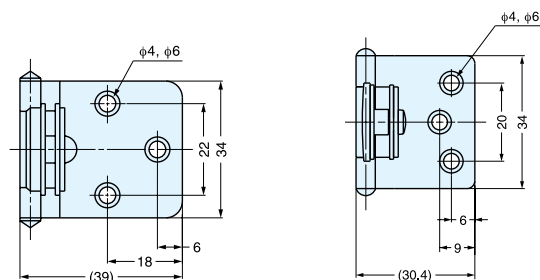

GH34/8SS

GH34/8CR

Available in 18-8 Stainless Steel or Chrome.  
 Glass Thickness: 5/32" to 15/64". Door weight max 8.8 lbs/pr.

Code	Finish	Ctn	List/ea
GH34-8SS	Stainless Steel	10	\$ 10.74
GH34-8CR	Chrome	10	8.59

## SUGATSUNE

## GLASS DOOR HINGES

### STAINLESS STEEL GLASS DOOR HINGES

No Drilling Required



- Pre-drilling on glass/acrylic NOT required
- Door thickness: 4-6mm
- Door size max: 17-3/4" W x 51-3/16" H
- Door weight max: 22 lbs/pr.
- Use 2 spacers for 4mm door thickness
- Screws included

XL-GH01-600

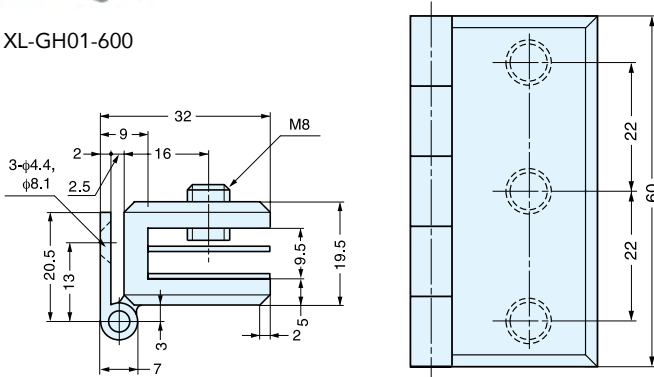

Code	Description	List/ea
XL-GH01-600	Glass Door Hinge, SS	\$ 87.96



- Pre-drilling on glass/acrylic NOT required
- Door thickness: 4-6mm
- Door size max: 15-3/4" W x 23-5/8" H
- Door weight max: 10.5 lbs/pr.
- Use 2 spacers for 4mm door thickness
- Screws included

XL-GH01-250

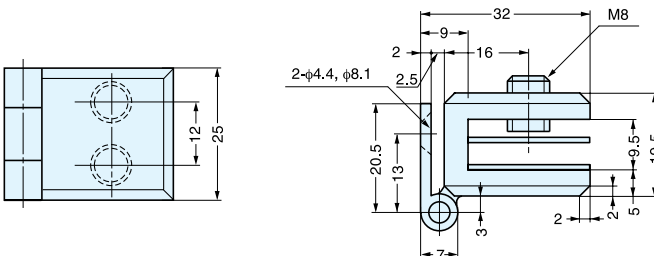

Code	Description	List/ea
XL-GH01-250	Glass Door Hinge, SS	\$ 55.71

### STAINLESS STEEL GLASS DOOR HINGES

Drilling Required



INSET

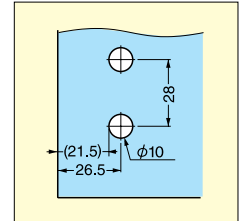

XL-GH03-48-0CR

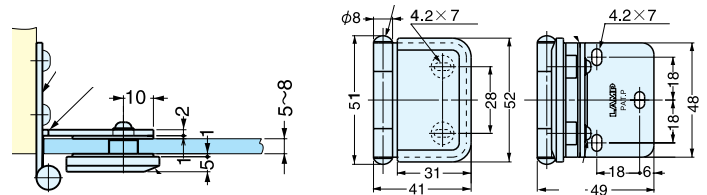

- Medium size hinge for glass/acrylic doors
- Door thickness: 5-8mm
- Door size max: 25-19/32" W x 35-7/16" H x 5/16"
- Door weight max: 26.4 lbs/pr.

Code	Description	List/ea
XL-GH03-48-0CR	Inset Glass Door Hinge	\$ 28.51



HALF  
OVERLAY

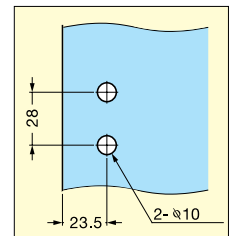

XL-GH03-48-8CR

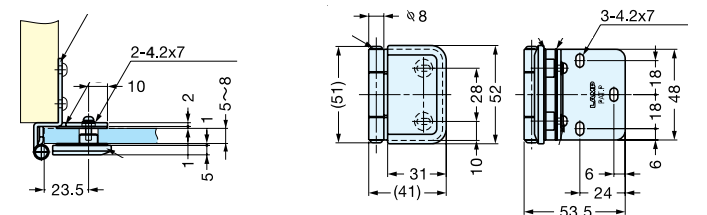

- Half-overlay (8mm, 5/16") hinge for glass/acrylic doors
- Door thickness: 5-8mm
- Door size max: 25-19/32" W x 35-7/16" H x 5/16"
- Door weight max: 26.4 lbs/pr.

Code	Description	List/ea
XL-GH03-48-8CR	Half Overlay Glass Door Hinge	\$ 29.42



## GLASS DOOR HINGES

### NO-BORE GLASS DOOR HINGE

Free Swing, Inset

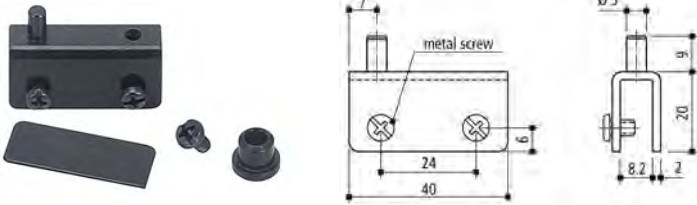

For Glass Thickness:  
4 - 6mm (5/32" - 15/64")

Free-swinging inset glass door hinge for glass thicknesses up to 15/64". For glass panel (door) size deduct 3/8" from inside cabinet height and 1/4" from inside cabinet width. Complete with screws, bushing, & pressure plate. Polybagged, 1 set per bag (One set needed per door).

Code	Finish	Ctn	List/bg
21690CH	Chrome	100 bgs.	\$ 2.54
21690BL	Black	100	1.89

### U-CHANNEL TOUCH PLATE

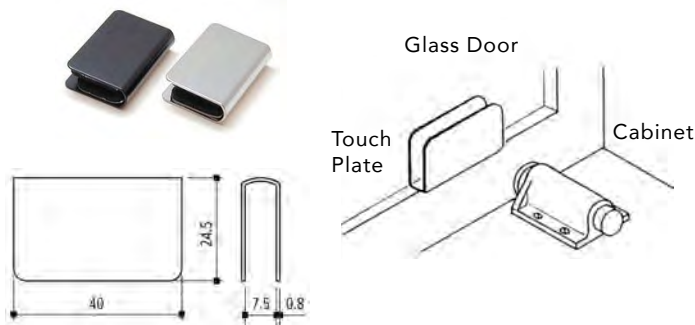

Steel touch plate with adhesive rubber. For glass thickness: 4 - 6mm (5/32" - 15/64").

Code	Finish	Ctn	List/ea
50020-PC	Chrome	100 ea.	\$ 1.90
50020-BLK	Black	100	.51

### NO-BORE GLASS DOOR HINGE

Self Close, Inset



For Glass Thickness:  
5 - 6mm (13/64" - 15/64")

Self-closing inset glass door hinge for glass thicknesses up to 3/16". Opening Angle: 170°. Max. Glass Size: 23-5/8" x 39-3/8". Max. Glass Weight: 22 lbs. Zinc die cast. For glass panel (door) size deduct 1/4" from top or side of inside cabinet dimensions. Built-in catch. Polybagged, 1 set per bag (One set needed per door). Screws included.

Code	Finish	Ctn	List/pr
21830PB	Brass	50 pr.	\$ 22.66
21830CH	Chrome	50	15.19

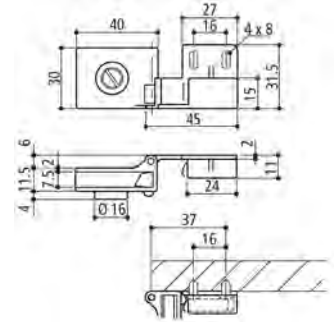

### NO-BORE GLASS DOOR HINGE

Self Close, Overlay



For Glass Thickness:  
5 - 6mm (13/64" - 15/64")

Self-closing overlay glass door hinge for glass thicknesses up to 3/16". Opening Angle: 170°. Max. Glass Size: 23-5/8" x 39-3/8". Max. Glass Weight: 22 lbs. Zinc die cast. Built-in catch. Polybagged, 1 set per bag (One set needed per door). Screws included.

Code	Finish	Ctn	List/pr
21840PB	Brass	50 pr.	\$ 9.66
21840CH	Chrome	50	9.35

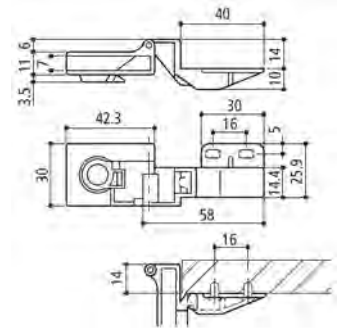

## TABLE TOP HINGES

### SEWING MACHINE/TABLE TOP HINGES

#### SMH30

Double Pivot and Flush with tabletop

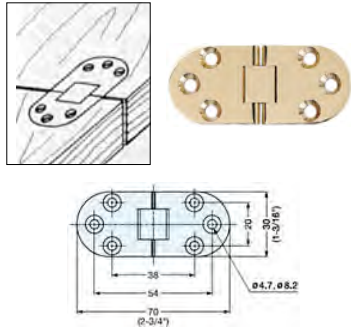

#### SMH83

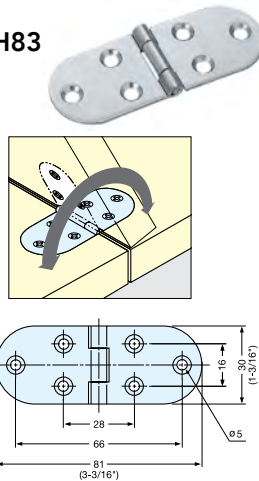

Table top hinges have a 180° pivot.  
 Door Size Max: 17-3/4" W x 27-9/16" H x 53/64"  
 Door Weight Max: 8.8 lbs/pr.

Code	Finish	Ctn	List/ea
SMH30PB	Polished Brass	24	\$ 29.42
SMH30SN	Satin Nickel	24	33.16
SMH83SS	Stainless Steel	10	7.48
SMH83CR	Chrome Plated	10	6.27

### TABLE TOP ALIGN-N-LOCK

- Eliminates table pins & levelers
- Positive CamLock - no spring to fail
- Low profile design for a strong, secure hold
- Dual strike provides multiple uses



The Align-N-Lock was designed with a much lower profile than a traditional sash lock. This in turn provides a much more direct pull on your surface making the gaps more seamless. The strikers U-shaped design aligns the top from side to side, eliminating the need for table pins. As the striker is pushed into the lock case, it levels the table top up and down. Finally, the positive cam lock firmly secures the top and filler leaves.

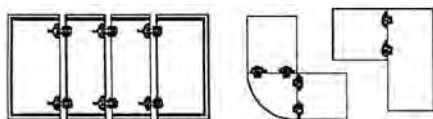

Code	Finish	Ctn	List/ea
TL107ABR	Antique Brass	100 ea.	\$ 4.41

## FLAP HINGES

### DROP LID HINGE

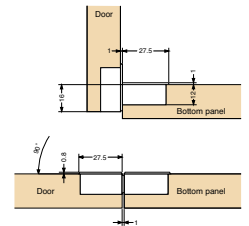
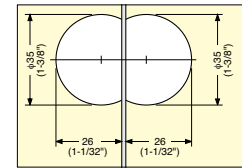

- Opening angle 90°
- Two way adjustment (Overlay and door gap)
- Flush when opened, ideal for writing desk application
- Can be used with soft down stay SDS-100, NSDX-10 or HDS-10
- Door thickness: 5/8" - 3/4"
- Overlay Coverage: 9/16" - 5/8"
- Head painted black pan screws available at a surcharge (Item #SDH-001-S-BL)

Code	Finish	Ctn	List/ea
SDH-001NI	Nickel	50 ea.	\$ 9.60
SDH-001BL	Black	50	10.62

### FLAP HINGE

Requires 35mm Hole

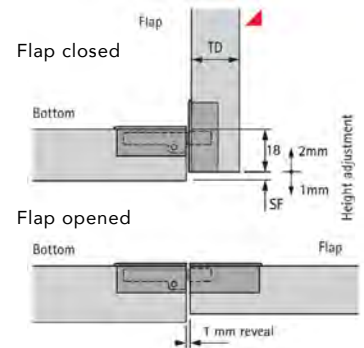

This hinge is invisible from the outside & ensures a firm & precise fitting. Flap is locked in position when the hinge is turned through 90°. Opened flap is flush with the base at a gap of 1mm. Universal mounting. 12mm recess depth of the two hinge sections. Has a covering rim to conceal the edge of the hole. Separate mounting of the base & the flap greatly simplifies installation and permits subsequent installation of lighter flaps. All metal - zinc alloy. 20 pcs/box with screws.

Code	Finish	Ctn	List/ea
1002686	Nickel Plated	20 ea.	\$ 12.08



**FOLDING DOOR HINGES**

**FLIP FLOP TABLE HINGE**

Brass Plated Steel

FFTH

- Spring loaded
- Material thickness:  
1/16" (1.9mm)
- Open size: L = 7-1/2"  
(19mm) x W = 5-1/8" (13mm)

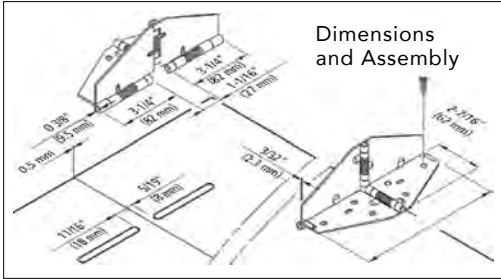

Brass plated, extra heavy 13 gauge steel, with friction catch and 4 heavy duty steel springs. Converts square table tops to round tops, adds length to oblong tops, increases seating capacity in a matter of seconds. This hinge is commonly used in restaurants and hotels. Leaf is held 180° underneath tabletop.

Code	Finish	Ctn	List/ea
FFTH	Yellow Chromate	50 ea.	\$ 13.85

**PARKER:** Double-Acting Hinge for Folding Doors. Allows panels to fold in either direction. Brass plated. 12 pr/box.



Code	Panel Thickness	Ctn	List/pr
1544-1	1"	12	\$ 6.26
1544-114	1-1/4"	12	6.65

**FOLDING DOOR HINGE**

Spring loaded

21050 Hinge

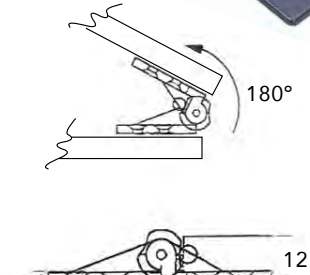
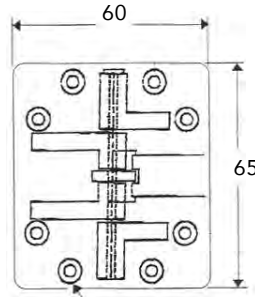

3.5x7-8 c's sink

Flipper

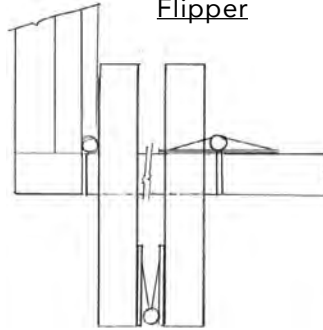

Overlay

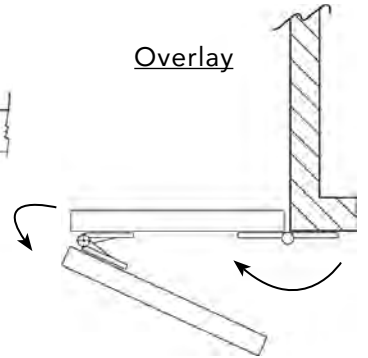

Flipper Doors Closed

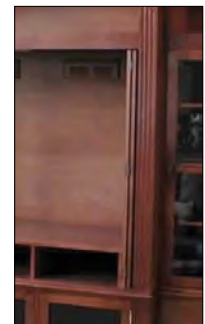

Doors Open w/ Flipper Door

Folding door hinge with adjustable tension. Spring loaded, door can lock in straight or folded position. Excellent for oversized entertainment center doors and flipper doors w/four doors. Sold per each.

Code	Finish	Ctn	List/ea
21050	Black	20 ea.	\$ 7.39

7

## **SALICE** WIND Lift System - Soft Close Kits

## WIND LIFT

A compact adjustable lift system that takes up a minimum of valuable storage space. The color coded springs makes inventory control and selection easy to understand. Installation on the door is as simple as boring a 35mm hinge cup hole.

Wind kits consist of a right and left mechanism, 2 door cups and a right and left mechanism housing. A Wind cover kit (Gray with nickel cover cap) will get added to the order automatically, although other colors are available. **Note:** The weight of the door must also be considered when selecting a lift system. See charts on the following pages for system selection by weight and door dimension.



- Integrated Soft Close feature; see Push to Open on page 806
- Spring Force adjustment, Soft Close adjustment
- Opening angle of 86 or 94 degrees
- Min door thickness: 5/8" (16mm), Max door thickness: 1-1/8" (28mm)
- Top overlay possibility: from 5/8" to 3/4"
- Edge bore distance on the door: 3 to 7mm
- Supplied with an angle reduction clip installed, reducing the opening angle to 86°. May be removed to achieve 94° if the 'K' boring distance on the door is 5mm or less
- Mechanism Adjustment:
 

Depth:	-1.0mm, +3.0mm
Side:	+2.0mm, -2.0mm
Height:	+2.0mm, -2.0mm



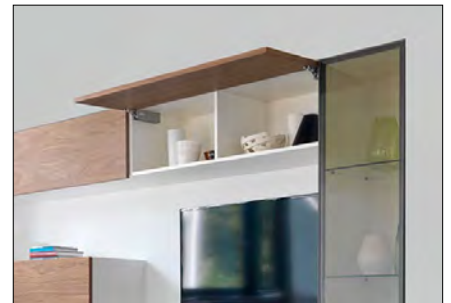

**Wind Mechanism Dimensions:**

1.5" W x 7.95" D x 2.25" H

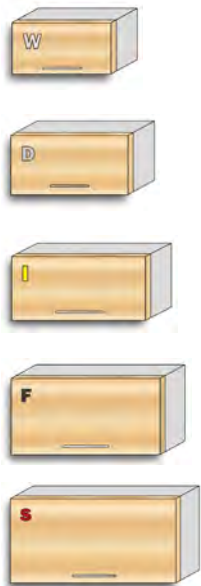

8



Code	Door Height	Door Weight	Spring Color Code Combination	List/Set
WIND-W	Min: 8-5/8" Max: 15-3/4"	Min: 1.75 lbs. Max: 11.5 lbs.	 (White Spring/ Free Swing)	\$ 86.02
WIND-D	Min: 8-5/8" Max: 24"	Min: 4 lbs. Max: 17 lbs.	 (Yellow Spring/ Free Swing)	86.93
WIND-I	Min: 12-9/16" Max: 24"	Min: 10.5 lbs. Max: 21 lbs.	 (Yellow Spring/ Yellow Spring)	136.45
WIND-F	Min: 12-9/16" Max: 24"	Min: 18.5 lbs. Max: 32 lbs.	 (Black Spring/ Black Spring)	143.29
WIND-S	Min: 12-9/16" Max: 24"	Min: 26 lbs. Max: 41 lbs.	 (Red Spring/ Red Spring)	142.96

**Cover Cap Sets, LH/RH**



WIND-COVER	<b>Gray</b> finish, nickel plated	\$ 6.96
WIND-COVER-SS	<b>Stainless Steel</b> finish, nickel plated	19.94
WIND-COVER-WH	<b>White</b> finish, nickel plated	14.21
WIND-COVER-BL	<b>Satin Black</b> finish, titanium plated	14.03



# WIND LIFT

## Charts and Spring Force Identification for Wind Kits

Use charts to determine the correct lift mechanism based on the door height and weight. When calculating the door weight you must include the weight of the decorative hardware. The maximum door width for two Wind lifts is 48" (1200mm).

Note: Wind can be used on doors that are larger or heavier by adding additional Wind lifts to the cabinet and door. This can be done by installing a center partition and adding additional Wind lifts or by utilizing the Top Mount Brackets with additional Wind lifts.

Thickness		Common material weight per sq/ft					
Inch	mm	Particle Bd.	MDF	Plywood	Hardwood	Softwood	Glass
1/8"	3						1.6
5/32"	4						2.0
1/4"	6.4						3.2
5/16"	8						4.0
3/8"	9.5						4.8
1/2"	12.7	2.0	2.3	1.7			6.4
5/8"	16	2.5	2.9	2.1	2.3	1.6	8.0
3/4"	19	3.0	3.5	2.5	2.7	1.9	9.6
7/8"	22	3.5	4.2	2.9			
1"	25.4	4.0	4.7	3.3	3.6	2.5	
1 3/8"	35	5.5	6.4	4.6	5.0	3.4	

Find Weight of Your Door  $(width\ in. \times height\ in.) \div 144 = door\ sq/ft.$   
 $door\ sq/ft \times weight\ per\ sqft = door\ weight$

### Chart for WIND-W

Min Door Height: 8-5/8"  
Max Door Height: 15-3/4"  
Min Door Weight: 1.75 lbs.  
Max Door Weight: 11.5 lbs.

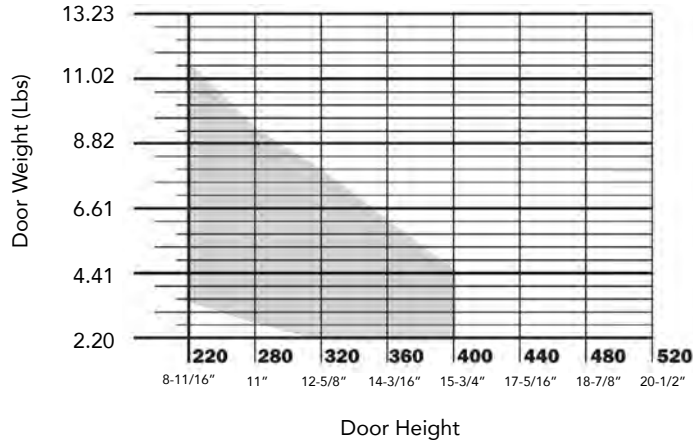
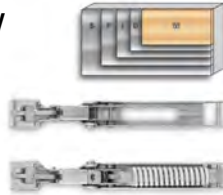

### Chart for WIND-I

Min Door Height: 12-9/16"  
Max Door Height: 24"  
Min Door Weight: 10.5 lbs.  
Max Door Weight: 21 lbs.

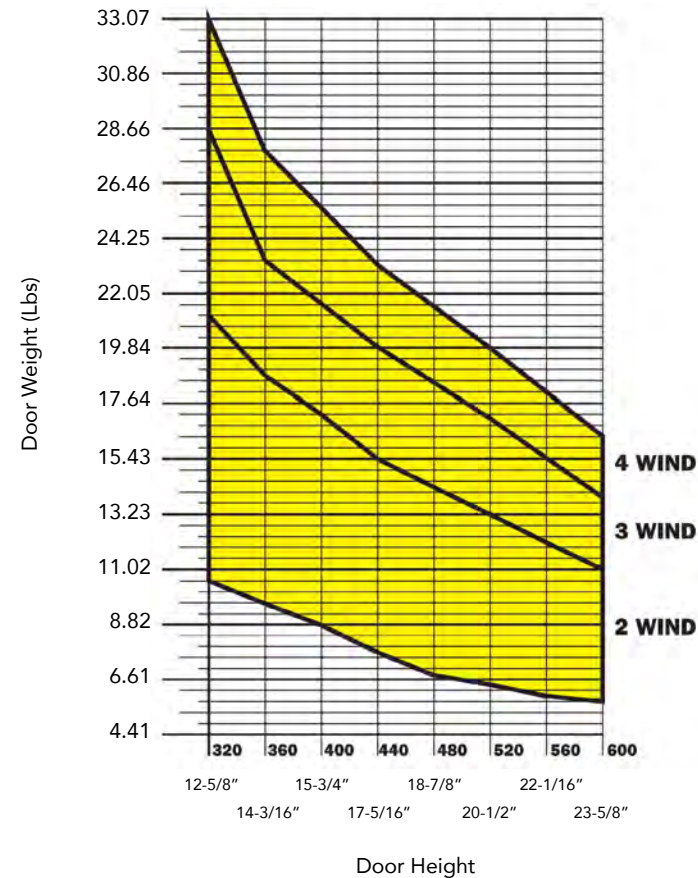
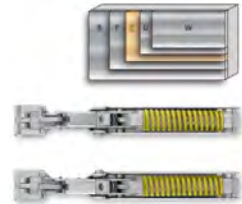

### Chart for WIND-D

Min Door Height: 8-5/8"  
Max Door Height: 24"  
Min Door Weight: 4 lbs.  
Max Door Weight: 17 lbs.

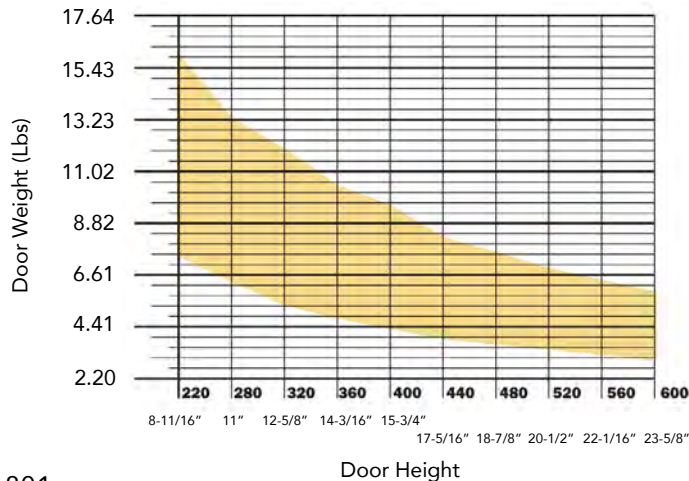
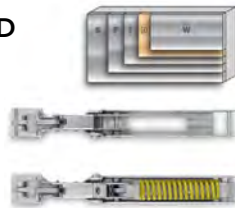



# SALICE

# WIND LIFT

Chart for WIND-F



Min Door Height: 12-9/16"  
 Max Door Height: 24"

Min Door Weight: 18.5 lbs.  
 Max Door Weight: 32 lbs.

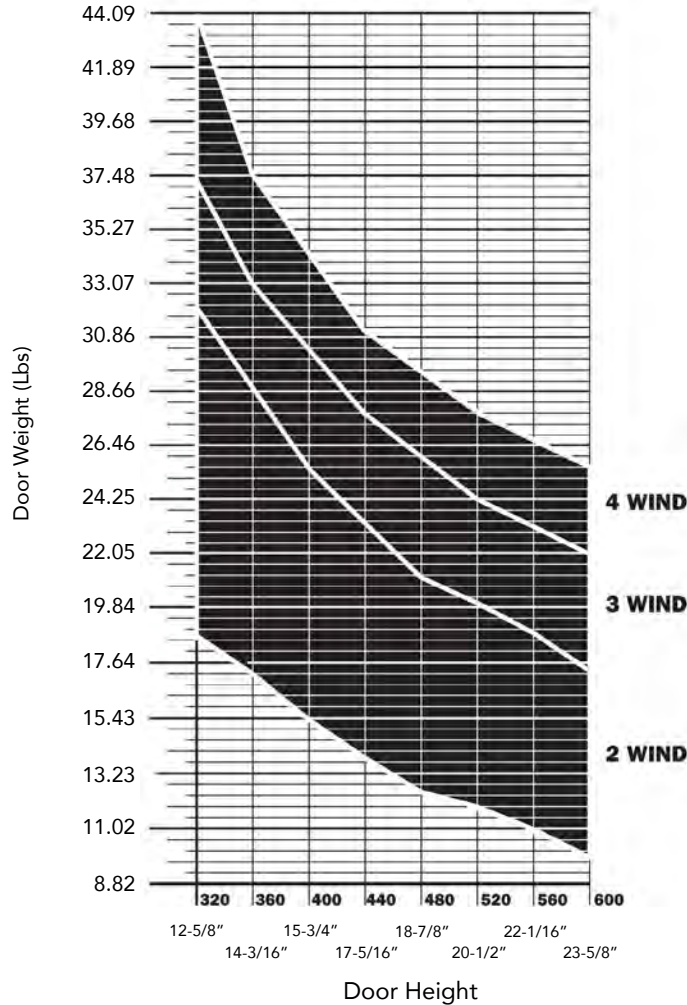
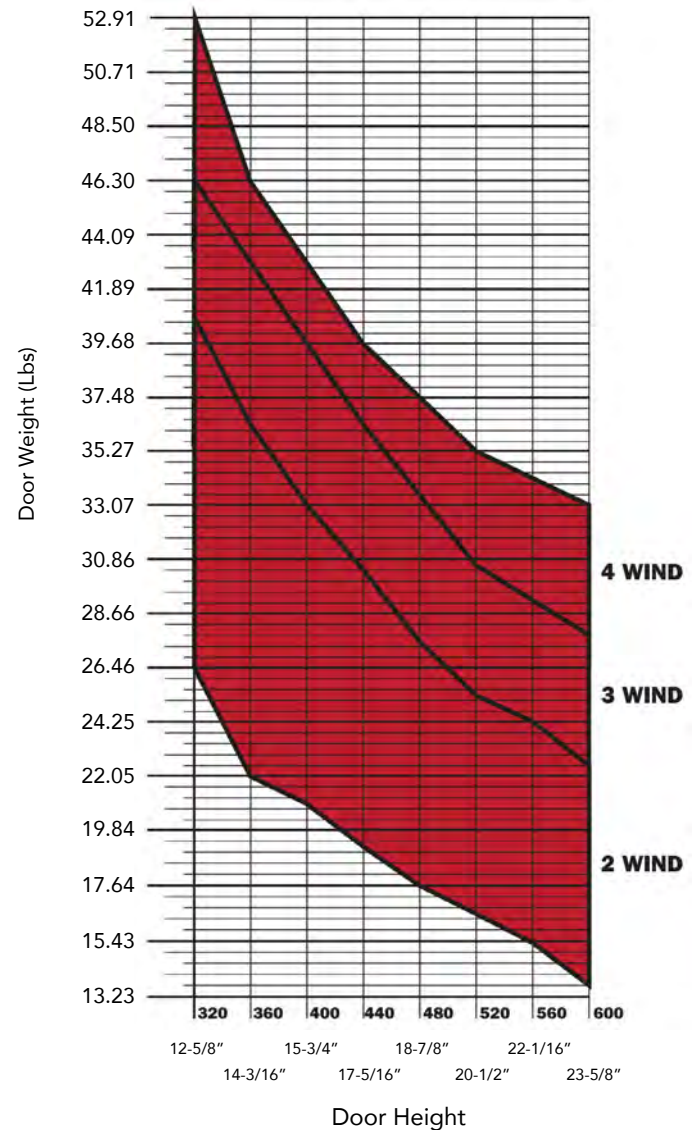

Chart for WIND-S



Min Door Height: 12-9/16"  
 Max Door Height: 24"

Min Door Weight: 26 lbs.  
 Max Door Weight: 41 lbs.



**Find Weight of the Door** (width in. x height in.) ÷ 144 = door sq/ft  
 door sq/ft x weight per sq/ft = door weight

Thickness		Common material weight per sq/ft					
Inch	mm.	Particle Bd.	MDF	Plywood	Hardwood	Softwood	Glass
1/8"	3						1.6
5/32"	4						2.0
1/4"	6.4						3.2
5/16"	8						4.0
3/8"	9.5						4.8
1/2"	12.7	2.0	2.3	1.7			6.4
5/8"	16	2.5	2.9	2.1	2.3	1.6	8.0
3/4"	19	3.0	3.5	2.5	2.7	1.9	9.6
7/8"	22	3.5	4.2	2.9			
1"	25.4	4.0	4.7	3.3	3.6	2.5	
1 3/8"	35	5.5	6.4	4.6	5.0	3.4	



**WIND Lift System**

**Face Frame Overlay Drilling Pattern**



Side View

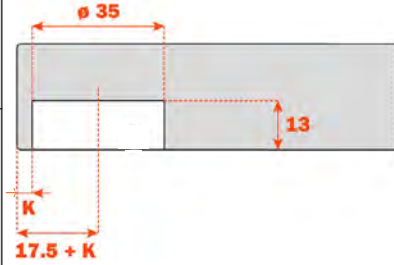
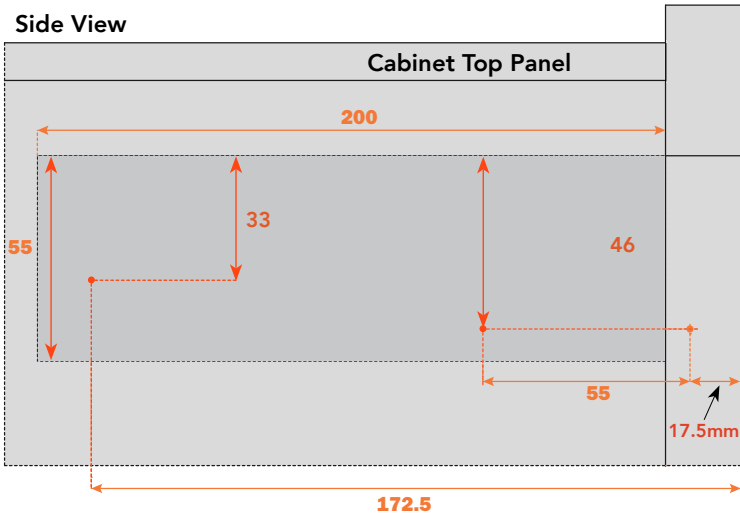

Bracket front edge is 3/8" in from front of opening

**K** = Drilling distance  
**D** = Door overlay on the cabinet side

33 = 1-1/4"  
 46 = 1-13/16"  
 17.5 = 11/16"

Top (Overhead) View

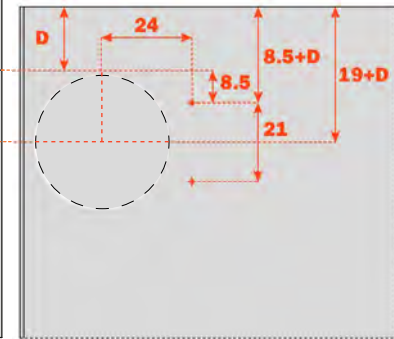
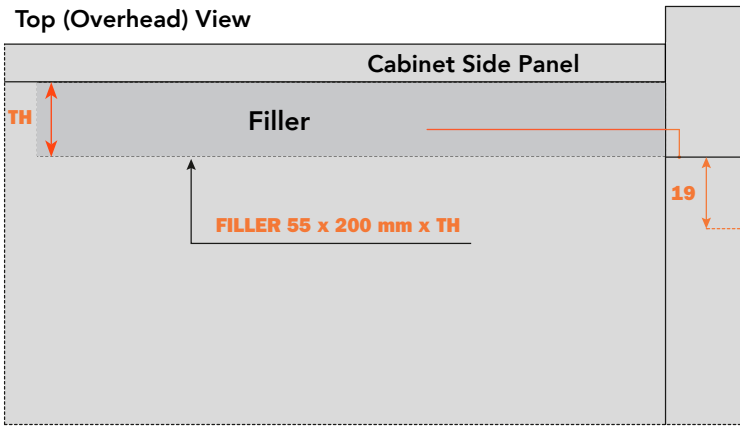

8

**Space needed to open the door**

Side View

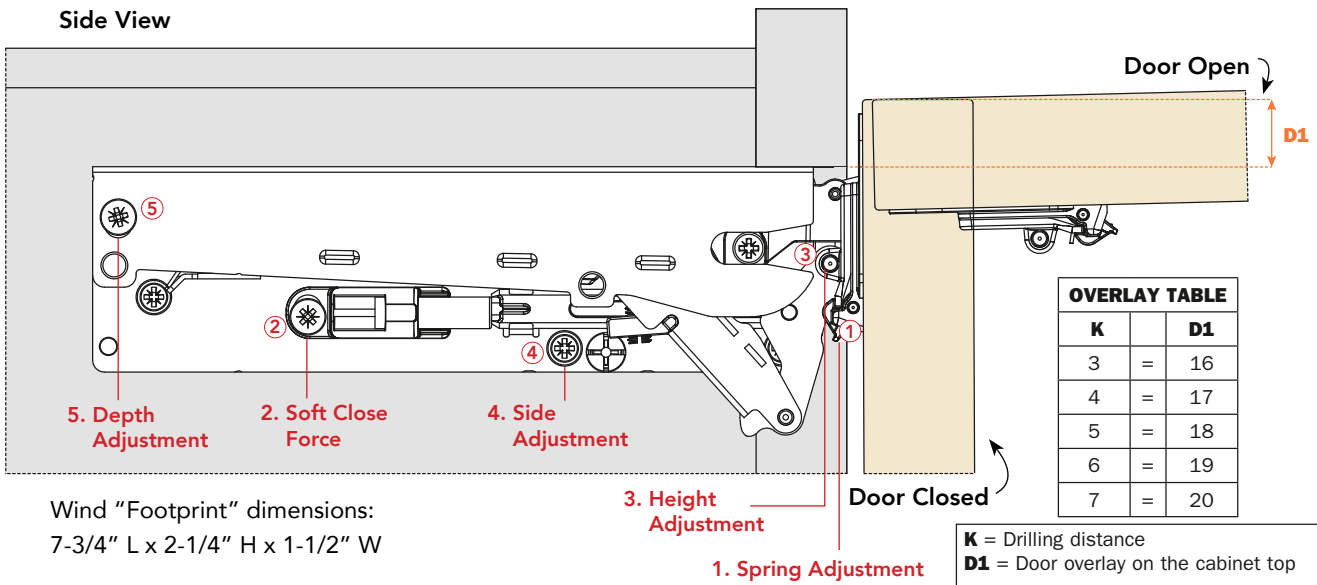

OVERLAY TABLE		
K	=	D1
3	=	16
4	=	17
5	=	18
6	=	19
7	=	20

**K** = Drilling distance  
**D1** = Door overlay on the cabinet top

Wind "Footprint" dimensions:  
 7-3/4" L x 2-1/4" H x 1-1/2" W



**SALICE**

**Frameless Overlay Drilling Pattern**

**WIND Lift System**

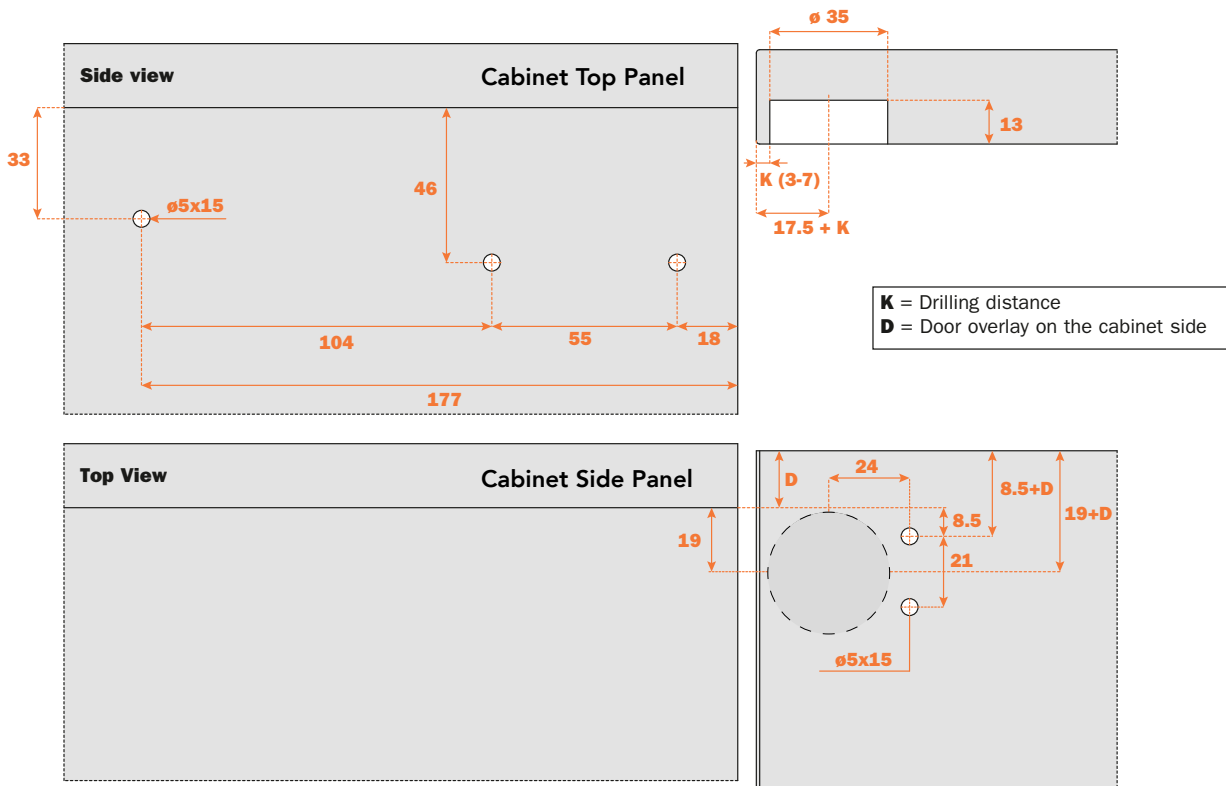

8

**Space needed to open the door**

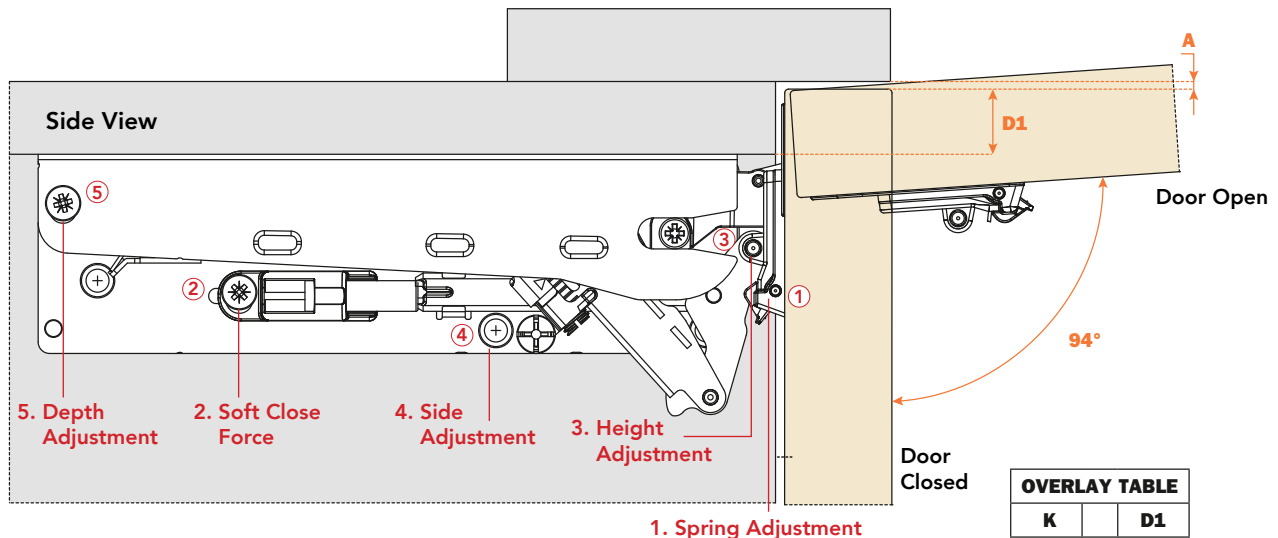

**MINIMUM REVEAL TABLE**

T=	16	17	18	19	20	21	22	23	24	25	26	27	28
K=3	A= 0	0.1	0.1	0.2	0.2	0.3	0.5	0.6	0.7	0.9	1.1	1.8	2.7
K=4	A= 0	0.1	0.1	0.2	0.2	0.3	0.4	0.6	0.7	0.9	1.1	1.3	2.1
K=5	A= 0	0.1	0.1	0.2	0.2	0.3	0.4	0.6	0.7	0.9	1.1	1.3	1.5
K=6	A= 0	0.1	0.1	0.2	0.2	0.3	0.4	0.6	0.7	0.9	1.0	1.2	1.5
K=7	A= 0	0.1	0.1	0.2	0.2	0.3	0.4	0.6	0.7	0.8	1.0	1.2	1.4

**OVERLAY TABLE**

K	D1
3	= 16
4	= 17
5	= 18
6	= 19
7	= 20

**K** = Drilling distance  
**D1** = Door overlay on the cabinet top  
**A** = Min Reveal

**T** = Thickness of door

For Inset, see next page



# **SALICE** WIND Lift System *Cont.*

Installation continued

## For Inset Installation

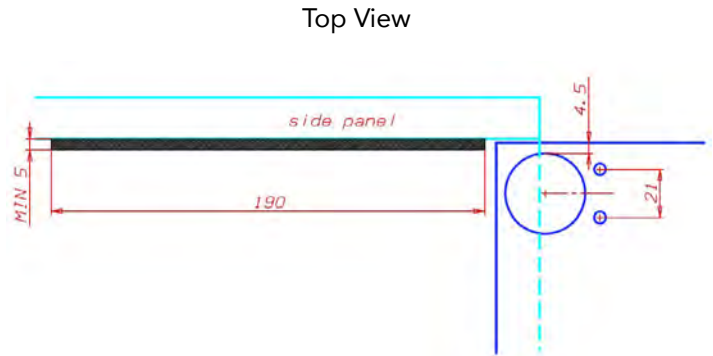
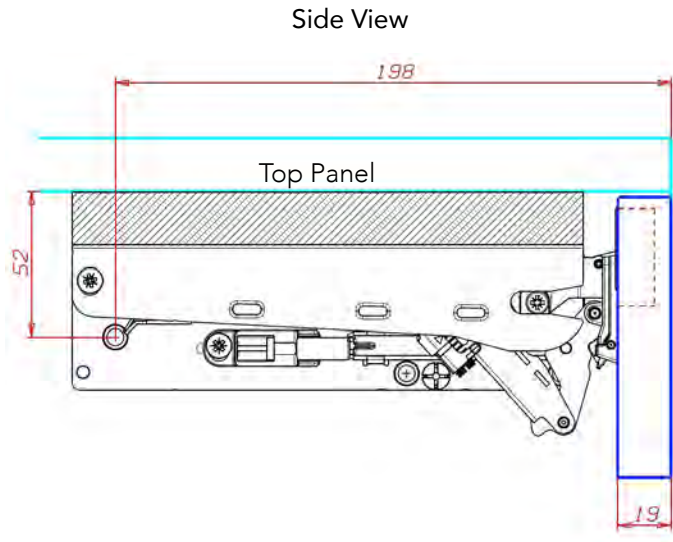

8

### OPTIONAL TOP MOUNT BRACKET SET



Bracket to be attached to the top of the cabinet for use with:

- Angled cabinets
- Wide or heavier doors
- 5 piece doors

Note: When using the top mount bracket, the overlay is reduced by 3mm. Refer to the overlay chart below.

**Each set contains:**  
2 Top Mount Brackets and  
2 Top Mount Covers

Code	List/Set
WIND-TM	\$ 26.13

WIND-TM



Top Mount Bracket w/ Cover

### Drilling Pattern

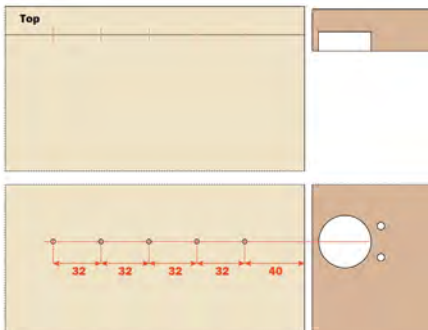

### Space needed to open the door

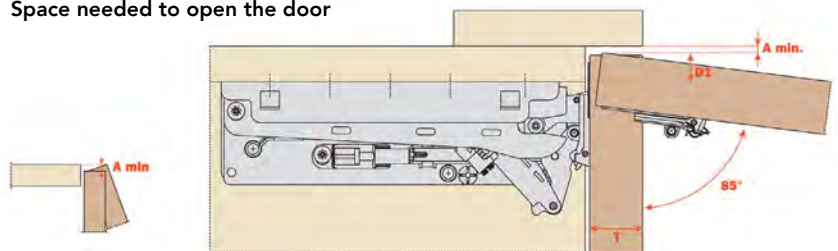

K	D1
3	= 13
4	= 14
5	= 15
6	= 16
7	= 17

	T=	16	17	18	19	20	21	22	23	24	25	26	27	28
K=3	A = min	0	0.1	0.1	0.2	0.2	0.3	0.5	0.6	0.7	0.9	1.1	1.8	2.7
K=4	A = min	0	0.1	0.1	0.2	0.2	0.3	0.4	0.6	0.7	0.9	1.1	1.3	2.1
K=5	A = min	0	0.1	0.1	0.2	0.2	0.3	0.4	0.6	0.7	0.9	1.1	1.3	1.5
K=6	A = min	0	0.1	0.1	0.2	0.2	0.3	0.4	0.6	0.7	0.9	1.0	1.2	1.5
K=7	A = min	0	0.1	0.1	0.2	0.2	0.3	0.4	0.6	0.7	0.8	1.0	1.2	1.4

**SALICE**

**WIND Lift System**



**Push to Open Kits**

Wind lift mechanism without soft close device, but with a push to open feature using release devices and retaining catches.

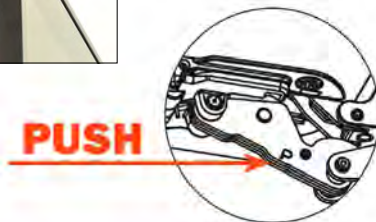

**Magnetic Push Release Device**



**DPMSNB**  
Release Device

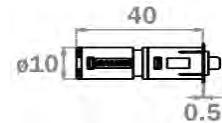

**Magnetic Push Release Device**

Release device to be used with DPMSNB for narrow cabinets (8-5/8" - 16")



**DPASNB**  
Release Device

**DP39XXG Retaining Catch**

Adjustable Magnetic Strike Plate



**DP28SN9 Retaining Catch**

Mag plate w/ nail

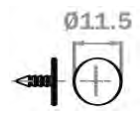

8

**For Cabinets 16" - 24" (406mm - 610mm)**

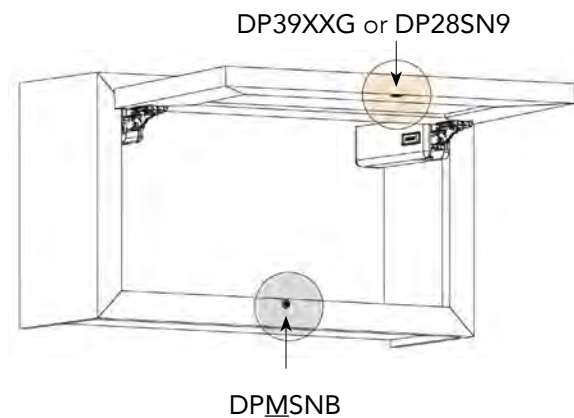

**For Cabinets 8-5/8" - 16" (220mm - 406mm)**

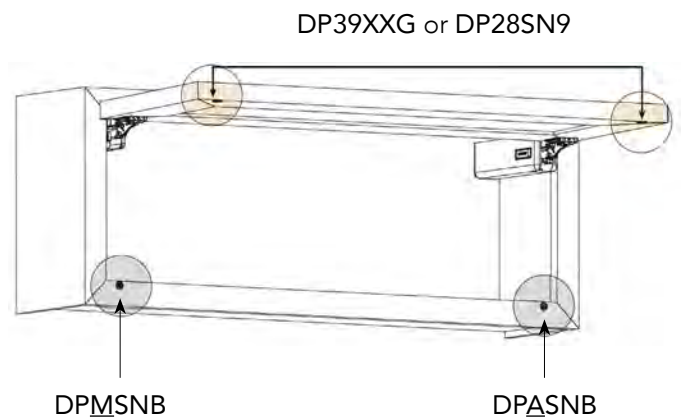

Code	Description	List/Set
WIND-WP ○ ○	Push - White/Free	\$ 99.29
WIND-DP ● ○	Push - Yellow/Free	99.83
WIND-IP ● ●	Push - Yellow/Yellow	166.23
WIND-FP ● ●	Push - Black/Black	159.95
WIND-SP ● ●	Push - Red/Red	155.00
WIND-COVER	L/R Cover Cap set	6.96

Code	Description	List/ea
DPMSNB	Beige Push Release Device	\$ 10.49
DPASNB	Beige Push Release Device for narrow cabinets	9.57
DP39XXG	Adj. Magnetic Strike Plate	8.99
DP28SN9	Magnetic Plate w/ nail	\$ 15.43/C

## PACTA HINGES



### PACTA: HINGES FOR DROP DOWN DOORS



The Pacta hinge system for drop down doors has a soft opening with a controlled, gradual fall of the door. In the fully-open position, the door and cabinet bottom are aligned, creating a flat surface.

Available in either Soft Opening with Self-close feature, or Push to open for handle-less doors. Pacta covers are offered in a variety of finishes to complement and blend with any interior.

Applications include: kitchen & bathroom cabinets, living room furniture and can also be used to create desks or writing surfaces.

**Select the correct kit for the door size and weight using charts on following page.**

**All Kits:** Door Height: Min: 11", Max: 16",  
 Door Thickness: Min: 5/8", Max: 1-1/8".

8

#### Manual open, Self close, Soft down Pacta kits

Kit includes: (2) Pacta self close hinges, (2) mounting plates, (2) smoves, (4) 5mm x 13mm euro screws, (2) #6 x 1" screws.

Code	Description	Min. Door Weight	Max. Door Weight	List/kit
PACTA-W	Type <b>W</b> , w/ Gray Smove	3 lbs.	9 lbs.	\$ 73.71
PACTA-I	Type <b>I</b> , w/ Tan Smove	7	15	74.64
PACTA-S	Type <b>S</b> , w/ Red Smove	9	21	76.34

#### Self Close & Push Close Kit



#### Color-coded Smove



#### Push open, Soft down Pacta kits

Kit includes: (2) Pacta push hinges, (2) mounting plates, (2) smoves, (4) 5mm x 13mm euro screws, (2) #6 x 1" screws.

Code	Description	Min. Door Weight	Max. Door Weight	List/kit
PACTA-WP	Type <b>W</b> , w/ Gray Smove	3 lbs.	9 lbs.	\$ 74.13
PACTA-IP	Type <b>I</b> , w/ Tan Smove	7	15	71.50
PACTA-SP	Type <b>S</b> , w/ Red Smove	9	21	73.73

Order Magnetic Release devices separately.



**DPMSNB**  
Release Device  
\$ 10.49 /ea



**DPASNB**  
Release Device  
\$ 9.57 /ea



**DP39XXG Catch**  
Magnetic Strike Plate  
\$ 8.99 /ea



**DP28SN9 Catch**  
Mag plate w/ nail  
\$ 15.43 /C

**Cover kits** Kit includes: 2 covers.

Code	Description	List/kit
PACTA-GRAY	Cover kit, "M" - Gray color	\$ 13.87
PACTA-WHITE	Cover kit, "1" - White color	21.31

#### Cover Kit (2 covers)





# SALICE

## PACTA HINGES

### PACTA: HINGE FOR DROP DOWN DOORS CONT.

**Center Hinge kits** (required for doors 30" or wider. Fully cam adjustable.)

Kit includes: (1) hinge, (1) cover set (door & cab), (4) 5mm x 10.5mm euro screws.

Center Hinge Kit



Code	Description	List/kit
PACTA-CH-GR	Center Hinge kit, "M" - Gray color	\$ 20.67
PACTA-CH-WH	Center Hinge kit, "1" - White color	23.64

### Door size and weight charts

Type W kit: Use One Smove (Gray)

Type W kit: Two Smoves (Gray)

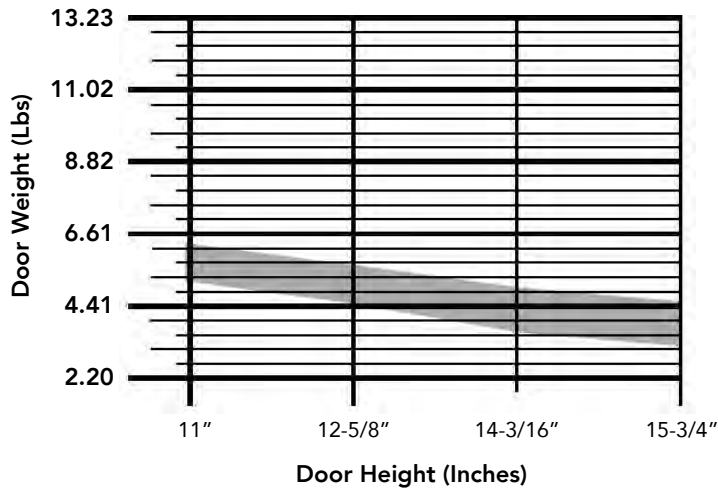

Type I kit: Two Smoves (Tan)

Type S kit: Two Smoves (Red)

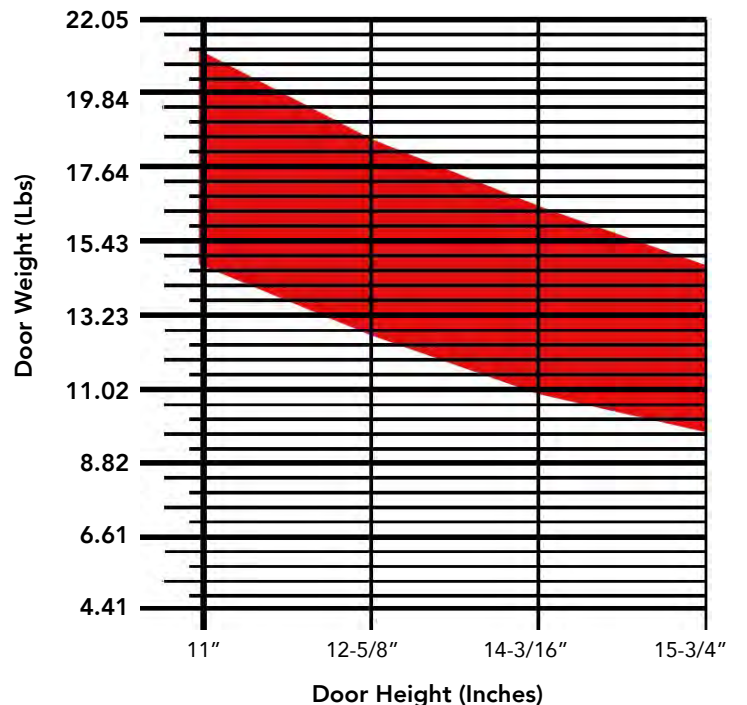
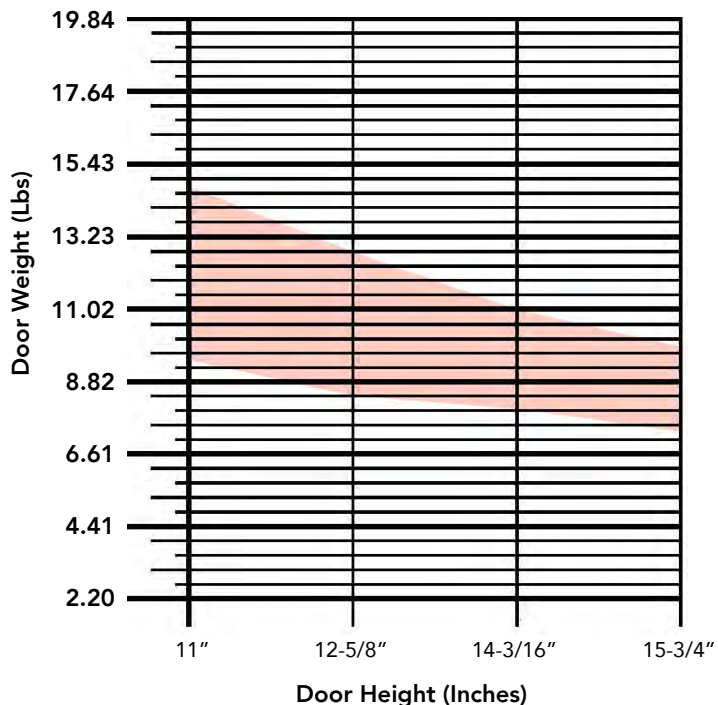

# LIFT UP STAYS



## Lift Assist Lid Stay - Aileron System



ARN-3

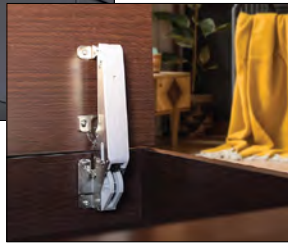

ARN-2

- Smooth door movement. Specially designed for use with the OLYMPIA concealed hinge
- Lift-assist function allows for light opening of doors
- Panel thickness: Min: 9/16" (15mm) ~ Max: 7/8" (22mm)
- Free-stop function enables doors to hold in position (30°-Max)
- Soft-close function makes doors close gently (0°-30° degrees)
- Integrated design combines a concealed hinge and lid stay
- Closing speed of doors is adjustable
- Nickel/grey finish

Each set includes the following components:

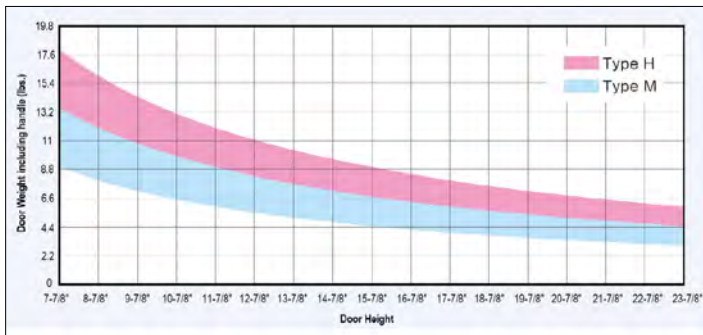

	Aileron	1
	Mounting plate for Aileron	1
	Olympia Concealed Hinge	2
	Mounting plate for Olympia	1
	Screws	16
	Olympia 8	
	Aileron 6	
	Aileron 2	

Refer to the above graph as a guide for model selection. For use with doors outside of the scope of this graph, use the calculation below. Door weight must include all attached accessories.

Torque (lbs • inch) =  
 Door height (inches) × 0.5 × weight (lbs).

### Lid Stay with Soft Close - for Top Opening

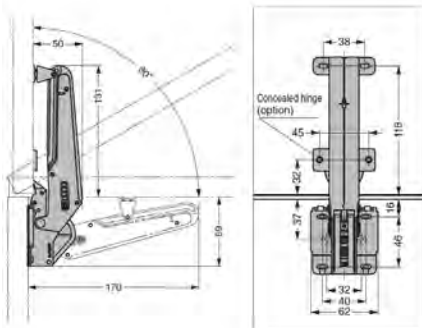

Code	Description	List/st
ARN-2-M-S	Med. Duty	\$ 57.63
ARN-2-H-S	Heavy Duty	57.63

### Lid Stay with Soft Close - for Upward Opening

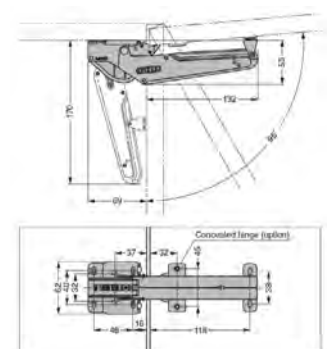
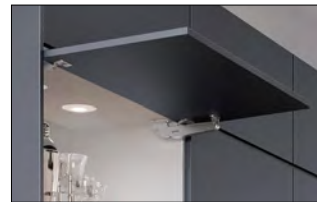

Code	Description	List/st
ARN-3-M-S	Med. Duty	\$ 57.63
ARN-3-H-S	Heavy Duty	57.63



## SUGATSUNE

## SOFT DOWN STAYS



The SDS mechanism allows the stop to release with a smooth, soft motion. Installation is quick and easy. Compact design. Speed and angle adjustment screws included. Plastic body, nickel plated steel arm. (For Flap, Continuous or Euro Hinges.)

### Flap Size

The size of the flap must be taken into consideration when ordering. The graph below indicates the usable range of door sizes allowed when 1 stay is used on a usual wooden flap of 20mm (3/4") thickness. Using 2 stays, the width of flap can be doubled if the height remains unchanged.

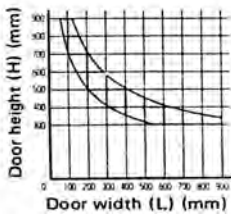
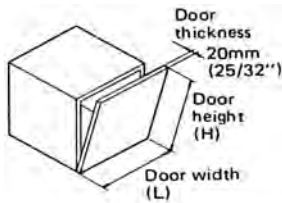

### Installation

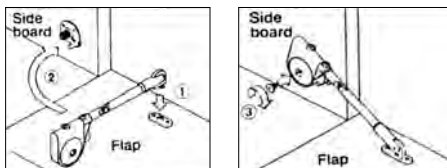

Install the mounting plate and arm fixing plate with the enclosed wood screws at the designated places.

1. Insert the 'Key' of the cam of the arm-tip into the key-hole of the arm fixing plate. The main body must be placed at 90° angle against the fixing plate.
2. Turn the main body 90° and insert the knurly axis of the mounting plate to the hole of the main body.
3. Then, fix the main body with the bind screw attached.

### SDSC100

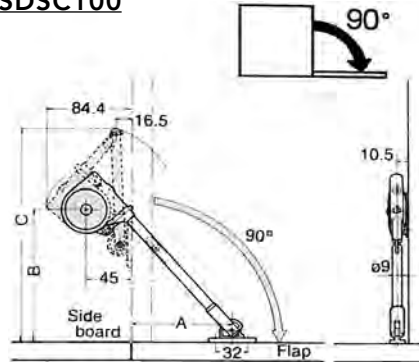

For downward opening flaps like those found on bureaus. Integral catch latches flap.

Code	Color	List/ea
SDSC100W	White	\$ 23.86
SDSC100BL	Black	23.86

### SDS200

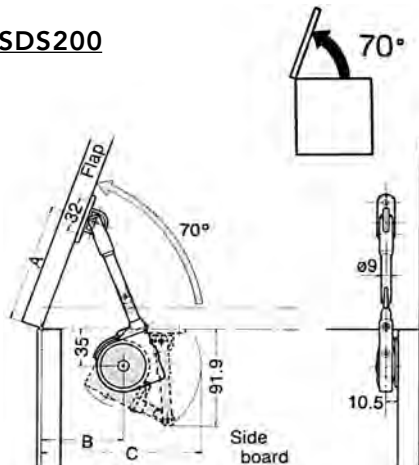

For top opening flaps. Plastic parts are white. Use with piano or Euro hinge.

Code	Hinge	List/ea
SDS200W	Piano	\$ 23.86

### SDSC301

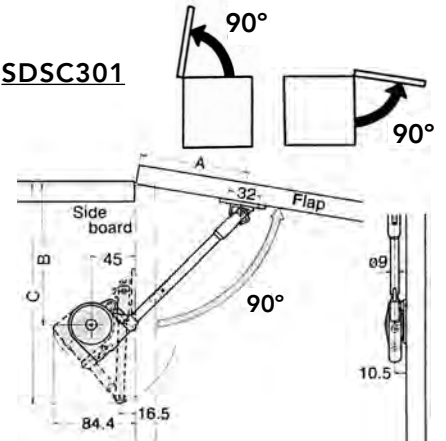

For upward opening flaps like those found on upper kitchen cabinets and for top opening such as toy chests. Integral catch.

Code	Color	List/ea
SDSC301NWH	White	\$ 23.35
SDSC301NBL	Black	23.35

### SDS210

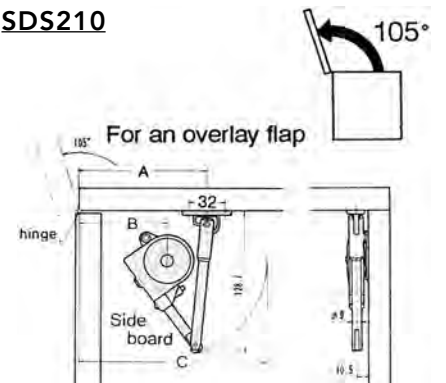

For top opening flaps that open to a 105° angle like on a vanity. Plastic is white. Use with flap or piano hinge.

Code	List/ea
SDS210W	\$ 23.25

## SOFT DOWN STAYS

## SUGATSUNE

### HEAVY DUTY SOFT-DOWN STAYS

HDS-10H



#### HDS-10H

- For DOWNWARD-OPENING FLAP DOOR with piano, butt or drop hinges.
- HDS-10 is designed to hold door in closed and open position
- Used in pairs

### HEAVY DUTY SOFT-DOWN STAYS

HDS-20H



#### HDS-20H

- For TOP-OPENING FLAP DOORS with piano, butt or drop hinges.
- HDS-20 is designed to hold door in fully opened position
- Used in pairs

With Piano / Butt Hinges

With Drop Hinge

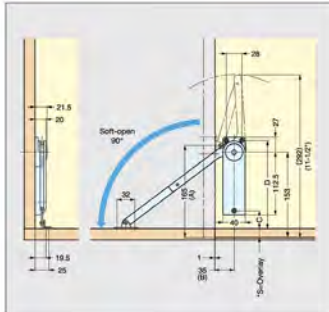
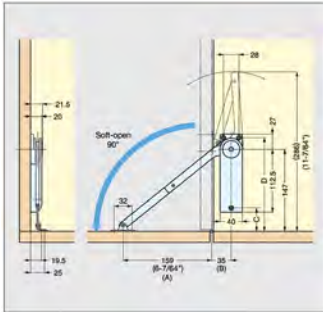

\*S=Overlay coverage in case of drop hinge

Hinge Type	A	B	C	D
Drop Hinge	165	35	48-S	174-S
Piano/Butt Hinge	159		42	168

Material	Finish/Color
Steel	Nickel
Plastic	Black, White

Available in Black or White. See page 796 for drop hinges SDH-001.

Soft Down Stays sold per each.

Code	Right	Torque	List/ea
Left	Right	lbs-in/pr.	List/ea
HDS-10HL	HDS-10HR	216-260	\$ 33.35

- Torque Calculation:  
 Torque = Door Height x 1/2 x Door Weight

Overlay Use

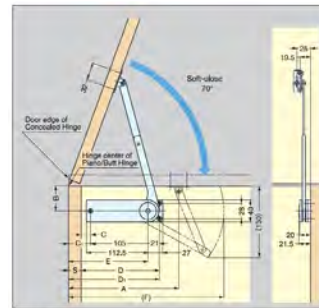

Hinge Type	A	B	C	D	C <sub>1</sub>	D <sub>1</sub>	E	F
Concealed Hinge	198.5	45	42-S	166-S	-	-	145.0	283.5
Piano/Butt Hinge	190	33	41	167	41	167	142.5	281.0

S=Overlay coverage in case of concealed hinge (mm)

Inset Use

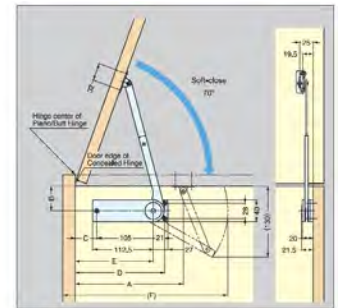

Hinge Type	A	B	C	D	E	F
Concealed Hinge	203	45	46	172	151	286
Piano/Butt Hinge	190	33	159	158	158	273

Available in Black or White. See page 796 for drop hinges SDH-001.

Soft Down Stays sold per each.

Code	Right	Torque	List/ea
Left	Right	lbs-in/pr.	List/ea
HDS-20HL	HDS-20HR	216-260	\$ 33.36

- Torque Calculation:  
 Torque = Door Height x 1/2 x Door Weight

# SUGATSUNE

# SOFT DOWN STAYS

## ADJUSTABLE SOFT-DOWN STAY

NSDX Series

### NSDX-10



- For DOWNWARD OPENING FLAP DOOR with piano, butt or drop hinges
- Designed to hold door in closed position
- Speed adjustment screw located on front for easy adjustment
- Torque Calculation:  
 $\text{Torque} = \text{Door Height} \times \frac{1}{2} \times \text{Door Weight}$   
 Per Piece: 19 - 60 lbs/in.  
 Per Pair: 38 - 120 lbs/in.

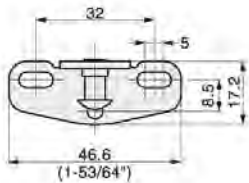

90° Opening

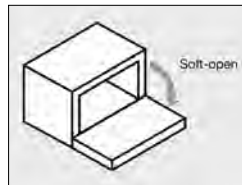

Arm Mounting Plate

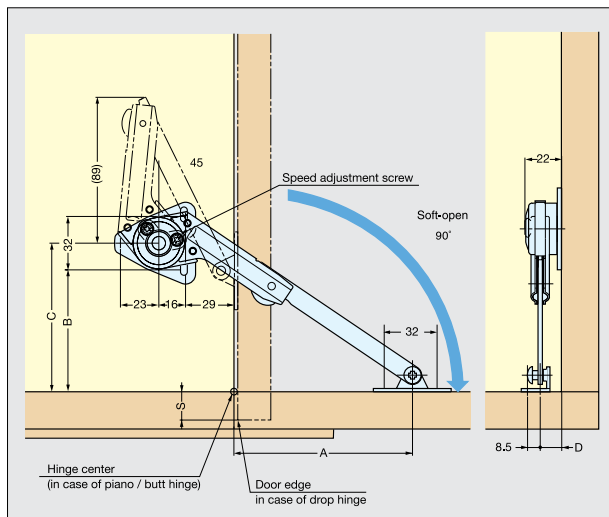

"S" dimension is the overlay coverage for drop hinge(s).

Hinge Type	A	B	C	D
Drop Hinge (SDH-001)	81+S	91	107	11
Piano / Butt Hinge	90	99	115	11

Code	Hand	Finish	Ctn	List/ea
NSDX-10RK	Right	Nickel	20	\$ 24.26
NSDX-10LK	Left	Nickel	20	24.26

## ADJUSTABLE SOFT-DOWN STAY

NSDX Series

### NSDX-20

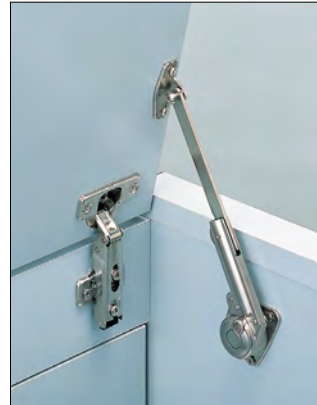

- For TOP OPENING FLAP DOOR with piano, butt or drop hinges
- Opening angle 70° or 105°
- Designed to hold door in fully opened position
- Speed adjustment screw located on front for easy adjustment
- Torque Calculation:  
 $\text{Torque} = \text{Door Height} \times \frac{1}{2} \times \text{Door Weight}$   
 Per Piece: 19 - 60 lbs/in.  
 Per Pair: 38 - 120 lbs/in.

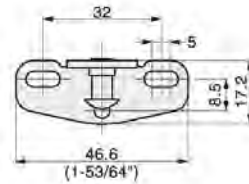

70° or 105° Opening

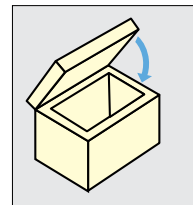

Arm Mounting Plate

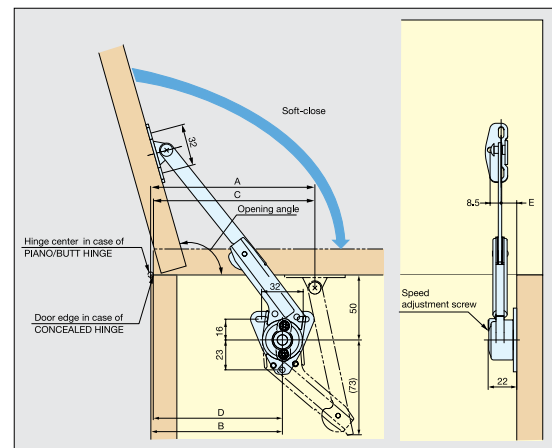

Opening Angle	Hinge Type	A	B	C	D	E
70°	Concealed Hinge	-	-	126	101	11
	Piano/Butt Hinge	125	100	-	-	
105°	Concealed Hinge	-	-	103	78	11
	Piano/Butt Hinge	97	72	-	-	

Code	Hand	Finish	Ctn	List/ea
NSDX-20RK	Right	Nickel	20	\$ 24.26
NSDX-20LK	Left	Nickel	20	24.26

## SOFT DOWN STAYS

## SUGATSUNE

### ADJUSTABLE SOFT-DOWN STAY

NSDX Series

### NSDX-35

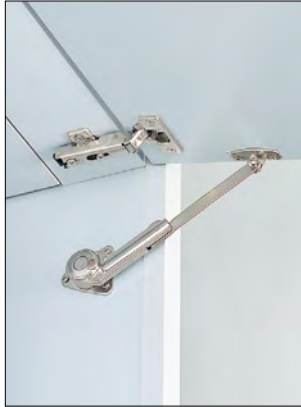

- For UPWARD OPENING FLAP DOOR with piano, butt or drop hinges
- Opening angle 80, 90 or 100°
- Designed to hold door in fully opened position
- Speed adjustment screw located on front for easy adjustment
- Two stop version (holds door at 65 and 90°) also available
- Torque Calculation:  
 $\text{Torque} = \text{Door Height} \times \frac{1}{2} \times \text{Door Weight}$   
 Per Piece: 19 - 60 lbs/in.  
 Per Pair: 38 - 120 lbs/in.

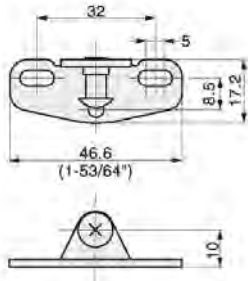

80°, 90°, 100° Opening

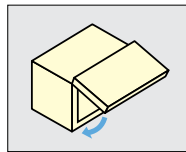

Arm Mounting Plate

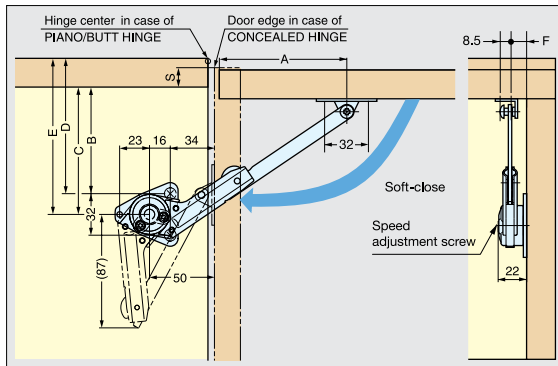

Opening Angle	Hinge Type	A	B	C	D	E	F
80°	Concealed Hinge	106	105 -S	121 -S	-	-	11
	Piano/Butt Hinge	100	-	-	99	115	
90°	Concealed Hinge	98	97 -S	113 -S	-	-	
	Piano/Butt Hinge	91.5	-	-	90.5	106.5	
100°	Concealed Hinge	92.5	91.5 -S	107.5 -S	-	-	
	Piano/Butt Hinge	85	-	-	84	100	

Code	Hand	Finish	Ctn	List/ea
NSDX-35RK	Right	Nickel	20	\$ 24.26
NSDX-35LK	Left	Nickel	20	24.26

### FACE FRAME BRACKET

### FOR SDS AND NSDX SERIES STAYS

FFCB-SD



- Works with SDS Series and NSDX Series on face frame cabinets
- Sold per piece
- Steel material, Chromate finish

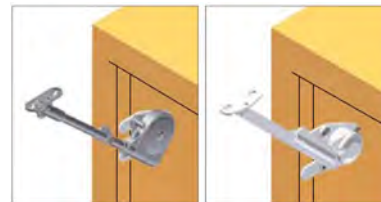
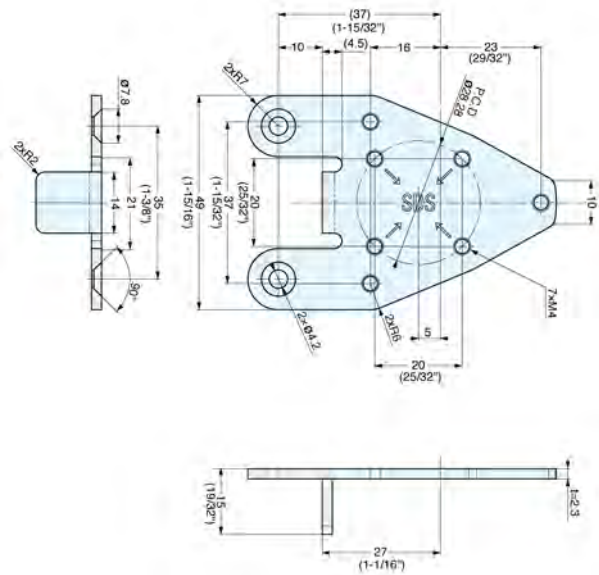

SDS Series

NSDX Series

Code  
 FFCB-SD

Description  
 Face Frame Bracket for  
 SDS and NSDX Series Stays

List/ea  
 \$ 7.40

# SUGATSUNE

# LIFT UP STAYS

## EASY LIFT UP STAY - SOFT CLOSE

SLS-ELAN



- Lapcon stay for upward-opening flap doors
- Lift-assist mechanism for extra light opening
- Door stays in any desired position
- Damper equipped for soft & silent closing at the end
- Slim design and installed location maximizes space inside of cabinet
- Simple installation by aligning body to edge of cabinet
- Single or pair use allows wide range of door size / weight
- Recognized by LGA for 40,000 cycles
- Optional bracket for aluminum frame door available



View this video and others here:  
<https://macpac1.com/videos.html#sugatsune>

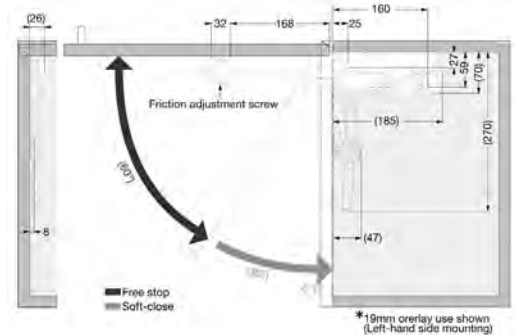
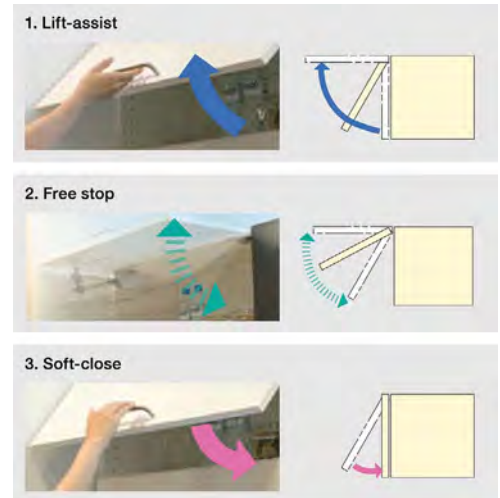

### Easy Installation

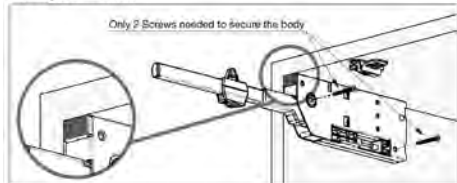

### Adjustment

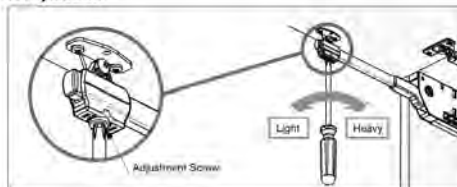

### See Chart:

Med. Duty up to 21 lbs/pr.  
 Heavy Duty up to 29 lbs/pr.



### FFCB-SLS

Bracket for face frame application. One bracket is needed for each stay.

Code	Description	List/ea
SLS-ELAN-MR	Med. Duty / RH Lift Up Stay	\$ 73.30
SLS-ELAN-ML	Med. Duty / LH Lift Up Stay	73.30
SLS-ELAN-HR	Heavy Duty / RH	73.30
SLS-ELAN-HL	Heavy Duty / LH	73.30
FFCB-SLS	Face Frame Bracket for above Stays	10.01

Door Height (inch)	Single use				Pair use			
	M-type		H-type		M-type		H-type	
	Min	Max	Min	Max	Min	Max	Min	Max
12"	8.0	10.8	10.8	14.5	16.0	21.7	21.7	29.0
13"	7.4	10.0	10.0	13.4	14.8	20.0	20.0	26.6
14"	6.9	9.3	9.3	12.4	13.7	18.6	18.6	24.9
15"	6.4	8.7	8.7	11.6	12.8	17.3	17.3	23.2
16"	6.0	8.1	8.1	10.9	12.0	16.3	16.3	21.8
17"	5.6	7.6	7.6	10.2	11.3	15.3	15.3	20.5
18"	5.3	7.2	7.2	9.7	10.7	14.4	14.4	19.3
19"	5.1	6.8	6.8	9.2	10.1	13.7	13.7	18.3
20"	4.8	6.5	6.5	8.7	9.6	13.0	13.0	17.4
21"	4.6	6.2	6.2	8.3	9.1	12.4	12.4	16.6
22"	4.4	5.9	5.9	7.9	8.7	11.8	11.8	15.8
23"	4.2	5.7	5.7	7.6	8.3	11.3	11.3	15.1
24"	4.0	5.4	5.4	7.3	8.0	10.8	10.8	14.5
25"	3.8	5.2	5.2	7.0	7.7	10.4	10.4	13.9
26"	3.7	5.0	5.0	6.7	7.4	10.0	10.0	13.4
27"	3.6	4.8	4.8	6.4	7.1	9.6	9.6	12.9
28"	3.4	4.6	4.6	6.2	6.9	9.3	9.3	12.4

\*Single or pair use depending on door size and weight.

## LIFT UP STAYS

## SUGATSUNE

### SWING LIFT-UP STAY

#### SLU-ELAN



- Swing Lift-Up for Doors
  - Soft & silent closing
  - Lift-assist for extra light opening
  - No hinges are required
  - Door stays in any desired position
- 
- Simple installation by mounting guide plate and slide in main body
  - Connecting bar stays on top for maximum access inside the cabinet - sold separately
  - Recommended Door Size and Weight:  
 Width: Max 59"  
 Height: 15-3/8" - 19-11/16" / door  
 Weight: 11 - 24.2 lbs.

**Connecting Bars** - sold separately - 2 sizes

	<u>Cab Width</u>	<u>Inside Dimensions</u>
ELB-780	900 (35-1/2")	856 - 866 (33-3/4 - 34-1/8")
ELB-1380	1500 (59")	1456 - 1466 (57-5/16 - 57-3/4")

**Face Frame Bracket** - Sold separately. Sold per pair.  
 Works with SLU-ELAN on face frame cabinetry.

Stays packed 5 sets/Ctn, Bars packed 5 ea/Ctn,  
 Brackets packed 4pr/Ctn.

<u>Code</u>	<u>Door Weight</u>	<u>List/set</u>
SLU-ELAN-S4	11 - 14.3 lbs.	\$ 376.70
SLU-ELAN-L4	14.3 - 17.6 lbs.	376.70
SLU-ELAN-M4	17.6 - 20.9 lbs.	376.70
SLU-ELAN-H4	20.9 - 24.2 lbs.	376.70
ELB-780	Connecting Bar, 780mm	23.86/ea
ELB-1080	Connecting Bar, 1080mm	40.00
ELB-1380	Connecting Bar, 1380mm	49.47
FFCB-SLU	Face Frame Bracket	32.35/pr



View this video and others here:  
<https://macpac1.com/videos.html#sugatsune>

### VERTICAL SWING LIFT-UP MECHANISM

#### SLUN

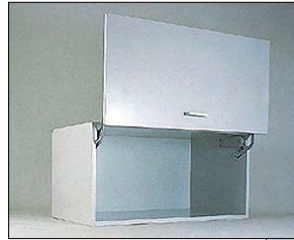

#### SLUN-5N

Up to 12.8 lbs.



- Unique mechanism will help lift doors and hold at the open position
- Sleek, compact design. Smooth, quiet motion.
- Material: Steel/Plastic, Color: Nickel/Gray
- Easy Installation
- Adjustable mounting plate
- Passed 30,000 open/close cycle tests
- Recommended Door Size:  
 Width: 23-5/8" - 35-7/16",  
 Height: 15-23/64" - 17-23/32" / door  
 Weight: 6.2 - 12.8 lbs.

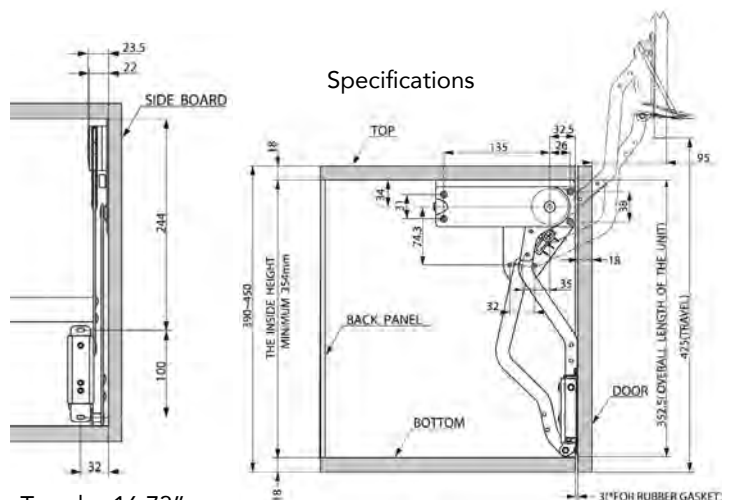

Travel = 16.73"

Guide Bar Included: 835mm (32-7/8")

Pack 5 Sets/Ctn.

<u>Code</u>	<u>Door Weight</u>	<u>List/set</u>
SLUN-3N	6.2 - 8.4 lbs.	\$ 171.87
SLUN-4N	8.4 - 10.6 lbs.	171.87
SLUN-5N	10.6 - 12.8 lbs.	171.87



## DELTA SOFT DOWN STAYS

### FITTING FOR LIDS, DROP-DOWN AND LIFT-UP DOORS

810.100.060



Function Actuator (AC) changes direction of brake from up-opening to down-opening.

Tension control Braking tension (BR) adjusts with #4 Allen wrench.

Simply pressing the actuator (AC) permits the upper arm to be passed to one side or the other, changing the braking action from braking when closing to braking when opening. In this way the functioning for lift-up doors and lids is changed to functioning for drop-down doors.

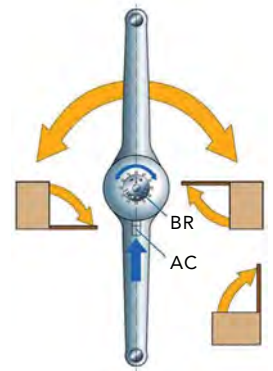

**Rated 20 lbs. each.**

- A B
- 8 90
- 9 91
- 10 92
- 11 93
- 12 95
- 13 96
- 14 97
- 15 98
- 16 99
- 17 100
- 18 101
- 19 102
- 20 103
- 21 103
- 22 104
- 23 105
- 24 105
- 25 106

### Vertical Lid Lift-Up to 90°

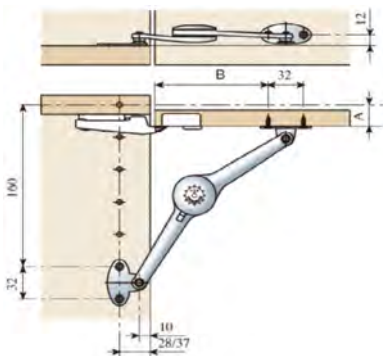

- Strong, die-cast nickel-plated zamak for lids up to 20 lbs! Lighter lids require only one fitting. Only 8" long overall.
- All holes on 32mm centers and can be placed either 27mm or 32mm from the leading edge for users of the 32mm combination drilling system.
- Reverses tension direction from LIFT-UP to DROP-DOWN function. Adjusts from sliding, braking action to hold at intermediate positions.
- Angle of opening varied from 75° to 90° by relocation of brackets and varies according to type of hinge used.

- A B
- 8 132
- 9 133
- 10 134
- 11 135
- 12 137
- 13 138
- 14 139
- 15 140
- 16 141
- 17 142
- 18 143
- 19 143
- 20 144
- 21 144
- 22 145
- 23 146
- 24 146
- 25 147

### Vertical Lid Lift-Up to 75°

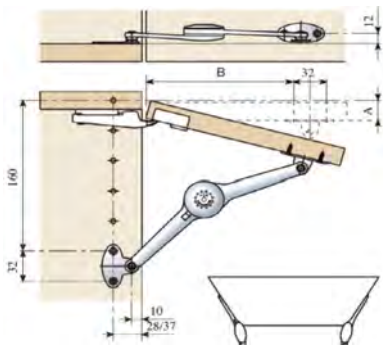

### Horizontal Lid Lift-Up to 75°

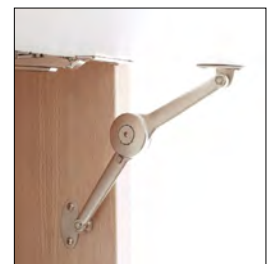
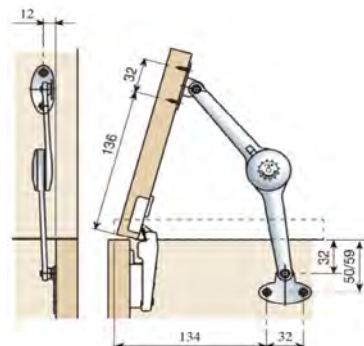

- Simple Application:  
Brackets are fastened to the cabinet separately and then snap onto the fitting!

- A B
- 8 98
- 9 99
- 10 100
- 11 101
- 12 103
- 13 104
- 14 105
- 15 106
- 16 107
- 17 108
- 18 109
- 19 110
- 20 111
- 21 111
- 22 112
- 23 113
- 24 113
- 25 114

### Vertical Lid Drop Down to 90°

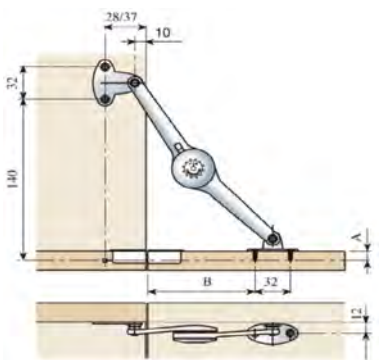

### Horizontal Lid Lift-Up to 90°

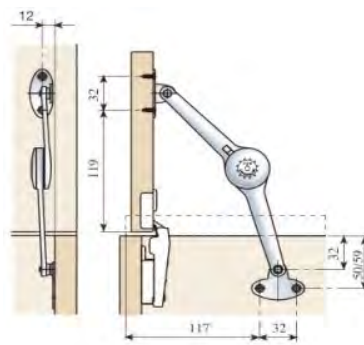

- Fastens interchangeably, LEFT or RIGHT.
- Each Bag contains:  
1 Fitting,  
1 Bracket for Side  
1 Bracket for Door

### Delta Lid Stay:

<u>Code</u>	<u>List/bg</u>
810.100.060	\$ 33.97



### FLAP STAYS

### LIFT ASSIST

#### HETTICH FLAP STAY

Klassik D

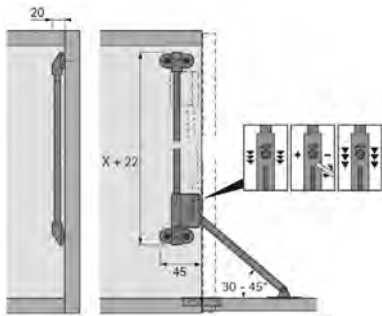

Case Interior Height: 17-1/2" - 19-5/8"  
Mounting Sizes: X = 10-11/16", L = 8-3/4"

8

The Hettich Klassik D Flap Stay is a high quality and problem-free braking system with precise adjusting possibilities. Non-handed.

Housing and bearing are die-cast nickel plated. Pull bar, foot, and guide bar are steel nickel plated.

Code	Description	Ctn	List/ea
16176	Flap Stay, Non-handed	10 ea.	\$ 29.98

#### LID STAYS

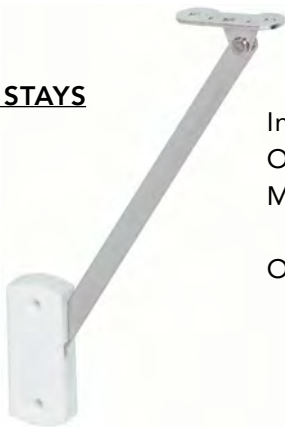

Inset or Overlay Mount

Overall Length: 9-7/8"

The stays have an automatic latching facility: Open by lifting the flap until the stay latches in position, close by slightly lifting the flap until the stay is released, allowing the flap to be closed. One stay is sufficient for light flaps, and two stays should be used for heavier flaps. White plastic, nickel plated metal parts. 250mm.

Code	Hand	Ctn	List/ea
373.73.729	Right	10 ea.	\$ 11.13
373.73.738	Left	10	10.36

#### LIFT ASSIST DAMPER W/ ANGLE STOPPER

Sugatsune

- Ideal for flip up countertop and bar counter applications
- Angle stopper designed to hold open at 95°



LAD-ST

- Damper equipped for smooth soft closing at the end - prevents countertop from slamming shut
- For panel thicknesses: 9/16 to 1-9/16" (15 - 40mm)
- Simple surface mount installation
- Chrome/Nickel finish

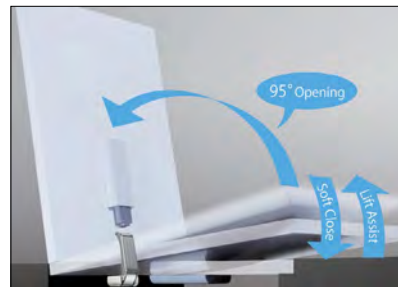

#### To Calculate Torque:

Door Weight x Door Height divided by 2.

#### Hinges (Sold Separately)



#### Unusable

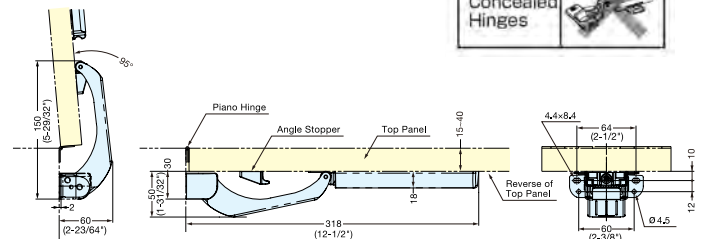

Code	Max. Torque per piece
LAD-ST-L	70.1 - 93.1 lbs/in.
LAD-ST-M	93.1 - 119.7 lbs/in.
LAD-ST-H	119.7 - 141.9 lbs/in.

Code	Description	List/ea
LAD-ST-L	Low Torque damper	\$ 106.16
LAD-ST-M	Med Torque damper	116.27
LAD-ST-H	Heavy Torque damper	121.32
LAD-DP1	Spacer, Gray, Door thickness: 1" - 1-3/8"	16.68
LAD-DP2	Spacer, Gray, Door thickness: 1-3/16" - 1-9/16"	17.79
LAD-BKT	Undermount Bracket	14.15





## SUPPORTS

### KV SUPPORT HINGE



Left or Right Handed. Fits 6" or 10" openings.  
Anochrome finish. Box of 12 pair with screws.

Code	Opening	Ctn	List/pr
472-6	6"	12 pr.	\$ 14.57
472-10	10"	12	13.50

### FOLDING SHELF BRACKET

Parker



1794

This folding steel shelf bracket is ideal for folding tables, work surfaces, book shelves or anywhere a foldaway shelf is required. 110 lb. load rating per pair.

Locks automatically in open position. Gray baked enamel finish.

Code	Size	Ctn	List/pr
1794-8	8" x 8"	12 pr.	\$ 20.16
1794-12	12" x 12"	6	27.55
1794-16	16" x 16"	6	37.87

### HETTICH LID SUPPORT

Flap Support Lift Junior



Assembly example

Spring tension 140N  
requires an additional  
fixing screw at position  
X panhead ø 3.5mm

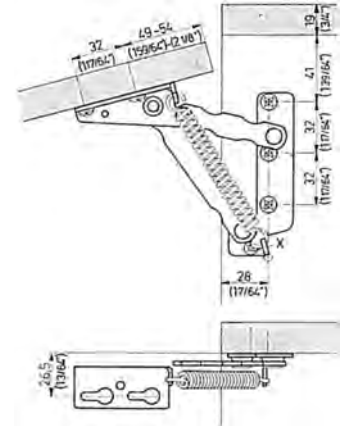

The Hettich Flap Support Lift Junior is an economical solution for small flaps. It has a neat and compact design and a safe and durable action. Choice of two spring tensions. Spring tension 20 lbs. (approx. 90N) and 30 lbs. (approx. 140N). Nickel plated.

Code	Spring	Hand	Ctn	List/ea
1001145	20 lb.	Right	10 ea.	\$ 7.79
1001144	20 lb.	Left	10	7.79
1001143	30 lb.	Right	50	9.37
1001142	30 lb.	Left	50	8.44

8

# LATERAL DOOR HINGE

# SUGATSUNE

## MONOFLAT LIN-X HINGE FOR LATERAL DOOR OPENING

Special Order



### Features:

- Lateral swing mechanism allows doors to swing out laterally in a small radius, ideal for tight front space application
- Stops in any position, flush in closed position
- Self & Soft closing, Clean appearance
- Material: Steel/Aluminum, Finish: Nickel/Anodized
- Can be opened from various points
- Maximum space availability: full access to inside of cabinet while door opened
- Designed for standard 32 system mounting

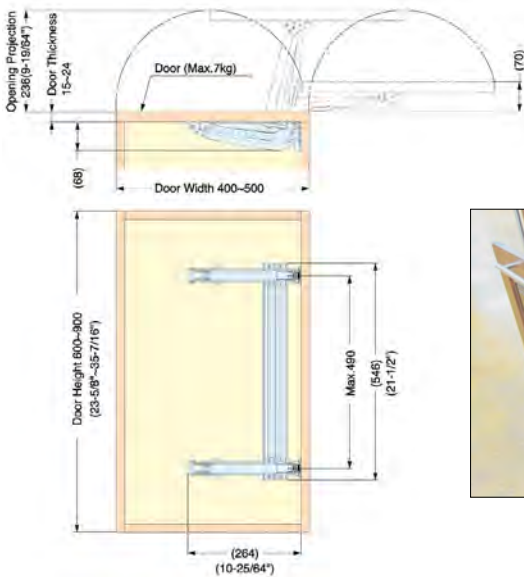

### Code

LIN-X450  
 LIN-X450+5

### Overlay

19mm (3/4")  
 14mm (35/64")

### List/set

\$ 208  
 208

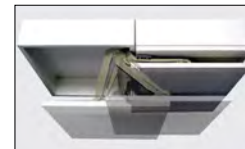

**Stops in any position**

**Self/Soft Closing**

Door Height	23-5/8" - 35-7/16"
Door Width	15-3/4" - 19-11/16"
Door Thickness	19/32" - 61/64"
Door Weight	15.4 lbs / door

### Snap-on Installation

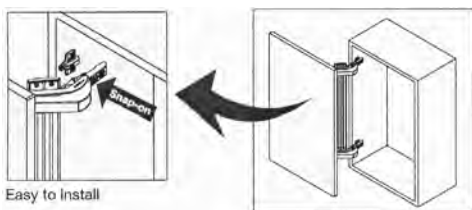

### Can be opened from various points

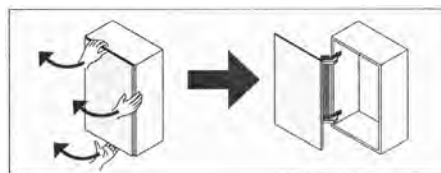

Please note handle position before installation.  
 Handle may interfere with hinge.

### Lateral Swing Mechanism



### 4-Way Adjustment

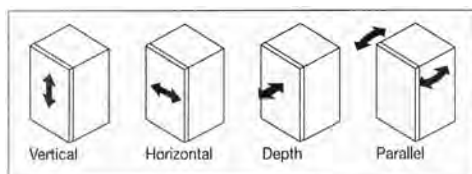

### Various Applications

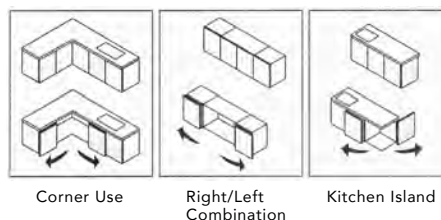

### Components





## CONTRACT BUTT HINGES



### HAGER BUTT HINGES - STANDARD WEIGHT

Commercial, Template, Steel Butt hinges with Square Corners and Button Tips.

1279 Plain-bearing
BB1279 Ball-bearing

Standard weight commercial butt hinges for use on wood or metal doors. Packed with wood screws. Available in plain-bearing and ball-bearing.

#### PLAIN BEARING, STANDARD WT, TEMPLATE

For use on medium weight doors requiring low frequency service (Not for use with door closer). Steel with steel pins.

##### Size: 3-1/2" x 3-1/2", 100 ea/bx.

Code	Finish	List/ea
1279-3-3.5	Polished Brass	\$ 14.44
1279-4-3.5	Dull Brass	8.53
1279-10B-3.5	Oil R Bronze	12.99
1279-15-3.5	Satin Nickel	12.57
1279-5-3.5	Antique Brass	11.32
1279-26-3.5	Polished Chrome	12.64
1279-26D-3.5	Dull Chrome	11.11
1279-P-3.5	Prime Coat	7.25

##### Size: 4" x 4", 48 ea/bx.

1279-3-4	Polished Brass	\$ 16.25
1279-4-4	Dull Brass	11.32
1279-10B-4	Oil R Bronze	14.19
1279-15-4	Satin Nickel	14.26
1279-15A-4	Antique Nickel	19.50
1279-5-4	Antique Brass	16.25
1279-26-4	Polished Chrome	14.19
1279-26D-4	Dull Chrome	12.90
1279-P-4	Prime Coat	8.91

##### Size: 4-1/2" x 4-1/2", 48 ea/bx.

1279-3-4.5	Polished Brass	\$ 14.27
1279-10B-4.5	Oil R Bronze	14.30
1279-26D-4.5	Dull Chrome	10.19
1279-P-4.5	Prime Coat	9.36

#### SOLID BRASS PLAIN BEARING BUTT HINGES

Square Corner. Stainless Steel pin. ORB finish.  
Other sizes and finishes are available special order.

Code	Size	Ctn	List/ea
1191-10B-4	4" x 4"	48 ea.	\$ 51.56

#### BALL BEARING, STANDARD WT, TEMPLATE

For use on medium weight doors or doors requiring medium frequency service.

##### Size: 3-1/2" x 3-1/2", 100 ea/bx.

Code	Finish	List/ea
BB1279-10B-3.5	Oil R Bronze	\$ 42.56

##### Size: 4" x 4", 48 ea/bx.

BB1279-3-4	Polished Brass	\$ 29.10
BB1279-10B-4	Oil R Bronze	28.86
BB1279-15-4	Satin Nickel	26.04
BB1279-26-4	Polished Chrome	24.06
BB1279-26D-4	Dull Chrome	25.61

##### Size: 4-1/2" x 4-1/2", 48 ea/bx.

BB1279-10B-4.5	Oil R Bronze	\$ 25.28
BB1279-26-4.5	Polished Chrome	24.20
BB1279-26D-4.5	Dull Chrome	13.53

##### Size: 5" x 5", 24 ea/bx.

BB1279-10B-5	Oil R Bronze	\$ 56.56
BB1279-26D-5	Dull Chrome	34.33

#### Comparison Chart

1279	=	2714	McKinney
BB1279	=	TA2714	McKinney
1250	=	1502	McKinney
1191	=	2314	McKinney



## BUTT HINGES

## EMTEK

### EMTEK STEEL BUTT HINGES - All Special Order Square Corner



Residential Duty  
Plain Bearing



Heavy Duty  
Plain Bearing



Heavy Duty  
Ball Bearing

### EMTEK STAINLESS STEEL BUTT HINGES - Square Corner All Special Order



Residential Duty  
Plain Bearing



Heavy Duty  
Plain Bearing



Heavy Duty  
Ball Bearing

Must specify finish - see chart below.

#### **8** Plain Steel, Residential Duty, Plain Bearing

Code	Size	List/pr
91013	3-1/2" x 3-1/2"	\$ 14
91014	4" x 4"	17

#### Plain Steel, Heavy Duty, Plain Bearing

Code	Size	List/pr
92013	3-1/2" x 3-1/2"	\$ 22
92014	4" x 4"	24
92015	4-1/2" x 4-1/2"	26

#### Plain Steel, Heavy Duty, Ball Bearing

Code	Size	List/pr
94013	3-1/2" x 3-1/2"	\$ 34
94014	4" x 4"	36
94015	4-1/2" x 4-1/2"	39

#### Stainless Steel, Residential Duty, Plain Bearing

Code	Size	List/pr
9811332DSS	3-1/2" x 3-1/2"	\$ 32
9811432DSS	4" x 4"	36

#### Stainless Steel, Heavy Duty, Plain Bearing

Code	Size	List/pr
9821332DSS	3-1/2" x 3-1/2"	\$ 34
9821432DSS	4" x 4"	42
9821532DSS	4-1/2" x 4-1/2"	53

#### Stainless Steel, Heavy Duty, Ball Bearing

Code	Size	List/pr
9841332DSS	3-1/2" x 3-1/2"	\$ 36
9841432DSS	4" x 4"	47
9841532DSS	4-1/2" x 4-1/2"	58

1/4" & 5/8" Radius Corner also available - call for pricing.

Available finishes: Polished Brass (US3), Satin Brass (US4), French Antique (US7), Oil R Bronze (US10B), Polished Nickel (US14), Satin Nickel (US15), Pewter (US15A), Flat Black (US19), Polished Chrome (US26), Med Bronze (MB), Tumbled White Bronze (TWB)

1/4" & 5/8" Radius Corner also available - call for pricing.



## BUTT HINGES

### PLAIN BEARING HINGES

Commercial Grade

- Square Corner
- Plain Bearing
- Packed with phillips flat-head screws

3.5 x 3.5" size: 0.123" ga.

4 x 4" size: 0.130" ga.

4.5 x 4.5" size: 0.134" ga.



<u>Code</u>	<u>Size</u>	<u>Finish</u>	<u>List/ea</u>
H35-00RBL	3.5" x 3.5"	Matte Black	\$ 12.67
H35-00ROB	3.5" x 3.5"	Oil R Bronze	14.55
H35-00RSN	3.5" x 3.5"	Satin Nickel	12.67
H44-00RBL	4" x 4"	Matte Black	14.89
H44-00ROB	4" x 4"	Oil R Bronze	10.62
H44-00RSC	4" x 4"	Satin Chrome	9.81
H44-00RSN	4" x 4"	Satin Nickel	9.81
H45-00ROB	4.5" x 4.5"	Oil R Bronze	14.19
H45-00RSC	4.5" x 4.5"	Satin Chrome	11.55
H45-00RSN	4.5" x 4.5"	Satin Nickel	12.25

### BALL BEARING HINGES

Commercial Grade

- Square Corner
- Ball Bearing
- Packed with phillips flat-head screws

4 x 4" size: 0.130" ga.

4.5 x 4.5" size: 0.134" ga.



<u>Code</u>	<u>Size</u>	<u>Finish</u>	<u>List/ea</u>
H44-02ROB	4" x 4"	Oil R Bronze	\$ 12.79
H44-02RSC	4" x 4"	Satin Chrome	11.78
H44-02RSN	4" x 4"	Satin Nickel	11.08
H45-02ROB	4.5" x 4.5"	Oil R Bronze	16.88
H45-02RSC	4.5" x 4.5"	Satin Chrome	14.92
H45-02RSN	4.5" x 4.5"	Satin Nickel	13.76

### STAINLESS STEEL RESIDENTIAL BUTT HINGE

Stanley

CD747-4-32



Solid stainless steel butt hinge for light weight residential doors in low frequency applications. Square corner, non-rising pin, hole in bottom tip for easy removal. Five knuckle, full mortise design.

Carded, one hinge per card with stainless steel screws. Pack: 5 cards/ box.

<u>Code</u>	<u>Size</u>	<u>Finish</u>	<u>List/cd</u>
CD747-3.5-32	3.5" x 3.5"	St. Steel	\$ 26.94
CD747-4-32	4" x 4"	St. Steel	29.70

### HAGER RESIDENTIAL BUTT HINGES

Square Corner, Plain Bearing Steel



**Size: 3-1/2" x 3-1/2", 100 ea/bx.**

<u>Code</u>	<u>Size</u>	<u>Finish</u>	<u>List/ea</u>
1741-10R-3.5	3.5" x 3.5"	Ant Bronze	\$ 5.66

## RADIUS CORNER

## BUTT HINGES

### HAGER RESIDENTIAL BUTT HINGES

1/4" Radius Corner, Plain Bearing Steel



RC1741-3.5"



RC1741-4"

Packed 100 each/box with wood screws.

Size: 3.5" x 3.5"	Finish	List/ea
RC1741-3-3.5	Pol. Brass	\$ 3.83
RC1741-4-3.5	Dull Brass	2.94
RC1741-P-3.5	Prime Coat	2.94
RC1741-15-3.5	Sat. Nickel	6.88
RC1741-26-3.5	Pol. Chrome	4.58
RC1741-26D-3.5	Dull Chrome	4.56
RC1741-10R-3.5	Ant. Bronze	5.02

Size: 4" x 4"	Finish	List/ea
RC1741-3-4	Pol. Brass	\$ 4.10
RC1741-4-4	Dull Brass	5.35
RC1741-P-4	Prime Coat	2.19
RC1741-15-4	Sat. Nickel	6.94
RC1741-26-4	Pol. Chrome	4.18
RC1741-26D-4	Dull Chrome	6.18
RC1741-10R-4	Ant. Bronze	5.59

### RESIDENTIAL BUTT HINGES

1/4" Radius Corner, Plain Bearing Steel



3.5" x 3.5"



4" x 4"

Packed: 1 pair per box with screws.

Code	Finish	Size	List/ea
RH-61-US10B	Oil R Bronze	3.5" x 3.5"	\$ 4.61
RH-61-US15	Satin Nickel	3.5" x 3.5"	4.61
RH-61-US26D	Satin Chrome	3.5" x 3.5"	2.57
RH-60-US10B	Oil R Bronze	4" x 4"	3.61
RH-60-US15	Satin Nickel	4" x 4"	2.98

### RESIDENTIAL BUTT HINGES

5/8" Radius Corner, Plain Bearing Steel



3.5" x 3.5"



4" x 4"

Packed: 1 pair per box with screws.

Code	Finish	Size	List/ea
RH-35-US10B	Oil R Bronze	3.5" x 3.5"	\$ 4.61
RH-35-US15	Satin Nickel	3.5" x 3.5"	4.61
RH-40-US10B	Oil R Bronze	4" x 4"	3.61
RH-40-US15	Satin Nickel	4" x 4"	3.27



## SOLID BRASS

## BUTT HINGES

### EMTEK SOLID BRASS HINGES - All Special Order Square Corner



Residential Duty  
Plain Bearing



Heavy Duty  
Plain Bearing



Heavy Duty  
Ball Bearing

Must specify finish - see chart below.

### Solid Brass, Residential Duty, Plain Bearing

Code	Size	List/pr
96113	3-1/2" x 3-1/2"	\$ 47
96114	4" x 4"	56

### Solid Brass, Heavy Duty, Plain Bearing

Code	Size	List/pr
96213	3-1/2" x 3-1/2"	\$ 58
96214	4" x 4"	66
96215	4-1/2" x 4-1/2"	76

### Solid Brass, Heavy Duty, Ball Bearing

Code	Size	List/pr
96413	3-1/2" x 3-1/2"	\$ 66
96414	4" x 4"	76
96415	4-1/2" x 4-1/2"	86
96416	5" x 5"	95

Available finishes: Lifetime Polished Brass (US3), Satin Brass (US4), French Antique (US7), Oil R Bronze (US10B), Polished Nickel (US14), Satin Nickel (US15), Pewter (US15A), Flat Black (US19), Polished Chrome (US26)

1/4" & 5/8" Radius Corner also available - call for pricing.

### DECORATIVE TIPS FOR EMTEK SOLID BRASS HINGES - All Special Order

4 Tips per set, List \$ /set



Ball Tips	for Hinges	List/st
97203	3-1/2" Res. Duty	\$ 22
97204	4" Res. Duty	22
97303	3-1/2" Heavy Duty	22
97304	4" Heavy Duty	22
97305	4-1/2" / 5" Heavy Duty	22



Steeple Tips		List
97213	3-1/2" Res. Duty	\$ 22
97214	4" Res. Duty	22
97313	3-1/2" Heavy Duty	22
97314	4" Heavy Duty	22
97315	4-1/2" / 5" Heavy Duty	22

### IDH SOLID BRASS BUTT HINGES

Standard Template

Standard weight,  
Plain bearing.  
Full Mortise, Square corner  
Butt hinge with button tips.  
Ball Tips available separately.



Packed: 1 pair per box with screws.

Code	Size	Finish	List/pr
83030-015	3" x 3"	Satin Nickel	\$ 45.80
83030-10B	3" x 3"	Oil R. Bronze	52.57
83535-015	3.5" x 3.5"	Satin Nickel	57.85
83535-10B	3.5" x 3.5"	Oil R. Bronze	60.51
84040-015	4" x 4"	Satin Nickel	59.02
84040-10B	4" x 4"	Oil R. Bronze	68.95
84545-10B	4.5" x 4.5"	Oil R. Bronze	88.11

### IDH SOLID BRASS BALL TIPS

Sold per each.

Code	Description	Ctn	List/ea
88100-015	Satin Nickel	4	\$ 3.59
88100-10B	Oil R Bronze	4	3.95



## BUTT HINGES

### ERIC MORRIS SOLID BRASS BUTT HINGES

Plain & Ball Bearing, Standard Weight



All Special Order

Screw-On  
 Finial Tips



11-BF  
 Ball

For use on wood or hollow metal doors and frames. Solid extruded brass with stainless steel pin. Finials are threaded into the barrel to prevent the pin from rising. Packed with button tips. Other finial tips can be ordered seperately.

Pack: 1 pr. per box with screws

#### Plain Bearing

Code	Size	Finish	List/pr
11-3535-605	3.5" x 3.5"	Pol. Brass	\$ 102.08
11-3535-613	3.5" x 3.5"	Oil R. Bronze	102.05
11-4040-605	4" x 4"	Pol. Brass	108.10
11-4040-613	4" x 4"	Oil R. Bronze	108.10
11-4040-619	4" x 4"	Satin Nickel	108.10
11-4040-605NL	4" x 4"	Brass, No Lacq	105.08
11-4545-613	4.5" x 4.5"	Oil R. Bronze	102.98
11-4545-619	4.5" x 4.5"	Satin Nickel	116.10

#### Ball Bearing

Code	Size	Finish	List/pr
11-4040BB-613	4" x 4"	Oil R. Bronze	\$ 135.00
11-4040BB-619	4" x 4"	Satin Nickel	135.00
11-4545BB-613	4.5" x 4.5"	Oil R. Bronze	141.00
11-4545BB-619	4.5" x 4.5"	Satin Nickel	141.00

#### Finial Tips - Screw-on 4/set

11-BF-605	Ball	Polished Brass	\$ 49.59
11-BF-613	Ball	Oil Rubbed Bronze	50.95
11-BF-619	Ball	Satin Nickel	50.95

### ROCKY MOUNTAIN HARDWARE - BUTT HINGES

Solid Bronze. 7/8" Barrel. All Special Order.



HNG4  
 4" x 4"

Shown in Silicon  
 Bronze Rust Patina  
 w/ Std. Finial Tip



HNG4.5  
 4.5" x 4.5"

Shown in White  
 Bronze Light Patina  
 w/ Ball Finial Tip



HNG4x5  
 4" x 5"

Shown in Silicon  
 Bronze Light Patina  
 w/ Dome Finial Tip



HNG5  
 5" x 5"

Shown in White  
 Bronze Dark Patina  
 w/ Steeple Finial Tip



HNG7x5  
 7" x 5"

Shown in  
 Silicon Bronze  
 Dark Patina  
 w/ Acorn  
 Finial Tip



CAP 1  
 Standard



CAP 2  
 Ball



CAP 3  
 Dome



CAP 4  
 Steeple



CAP 5  
 Acorn

Hinges and caps are available in all 12 Rocky Mountain Metal/Patina combinations. Hinge #s specify 7/8" barrel size. Prices shown below include hinge and any style cap. Some sizes, finishes available on RMH Express - call office for details. **Special Order Only.**

Code	Size	List/ea	List/pr
HNG3.5	3.5" x 3.5"	\$ 196	\$ 392
HNG4	4" x 4"	200	400
HNG4.5	4.5" x 4.5"	208	416
HNGWT4x5	4" x 5"	206	412
HNG5	5" x 5"	214	428
HNG7x5	7" x 5"	240	480



## BRASS DOOR HINGES

### BALDWIN FULL MORTISE HINGES

Solid Extruded Brass - Standard Weight

Full mortise hinges are accurately machined for precise installation and smooth movement. Knuckles are milled to a clearance of .010" (.3mm) to eliminate friction wear. Special threaded tip design allows complete interchangeability of tip finials with all full mortise hinges.

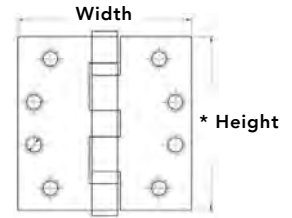

Supplied with  
 Button Tips

\* Height of hinge is  
 always first dimension  
 not including tip.

### PLAIN BEARING - Solid Brass

Solid extruded brass hinges. Stainless steel pin. Supplied with button tips. Other decorative tips available at extra cost. Template screw location for use on either wood or hollow metal doors & frames. NRP (Non-Removeable Pins) stocked in some sizes. One each per box with wood screws.

Pack: One each/box

Code	Size	Stock Finishes	List/ea
1030-XXX-I	3" x 3"	003, 102	\$ 47.04
1035-XXX-I	3.5" x 3.5"	003, 050, 056, 060, 102, 112, 151, 260	50.04
1040-XXX-I*	4" x 4"	003, 050, 056, 060, 102, 112, 151, 260, 264	54.05
1045-XXX-I	4.5" x 4.5"	056, 102, 112, 260	58.05

Other finishes available Special Order.

### BALL-BEARING - Solid Brass

Ball-Bearing, Solid Brass. Stainless steel pin. Supplied with button tips. Other decorative tips available at extra cost. Permanently lubricated, anti-friction ball-bearing assemblies. Template screw location for use on either wood or hollow metal doors & frames. Inner leaf is beveled to prevent weather elements from entering through the hinge. For standard weight doors and closers. NRP (Non-Removable Pins) stocked in some sizes. One each per box with wood screws.

Pack: One each/box

Code	Size	Stock Finishes	List/ea
1041-XXX-I*	4" x 4"	003, 050, 056, 102, 112, 260	\$ 67.06
1046-XXX-I	4.5" x 4.5"	003, 056, 102, 260	70.06
1051-XXX-I	5" x 5"	056, 102	101.09

Other finishes available Special Order.

\*Also stocked NRP

### BALDWIN HINGE TIPS - Solid Brass

Solid Brass hinge finials can be used on all square corner Baldwin hinges. Sold per pair.



Code	Tip	Stock Finishes	List/ea
1090-XXX-I	Ball	003, 050, 102, 112	\$ 19.02
1091-XXX-I	Urn	-	19.02
1092-XXX-I	Acorn	102, 112	19.02
1093-XXX-I	Steeple	-	19.02

Other finishes available Special Order.

### Finish Codes

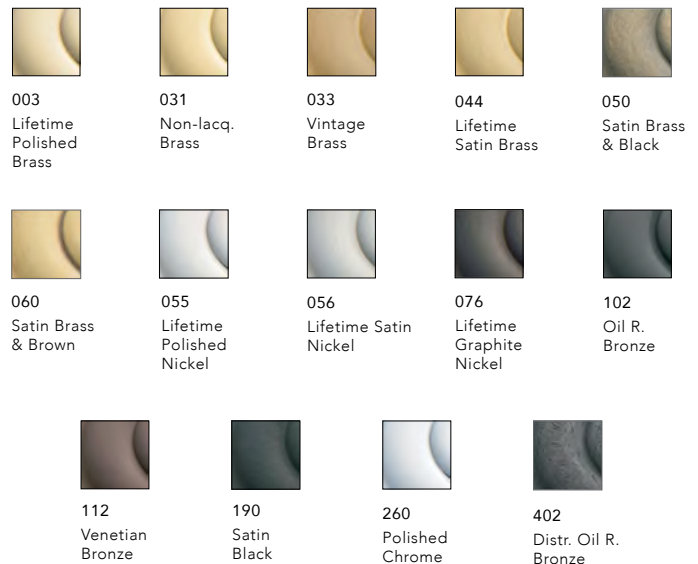



## WIDE THROW

### HAGER WIDE THROW

#### FULL MORTISE BALL-BEARING HINGE



Standard Weight  
Wide Throw  
WTBB1279

This full mortise ball-bearing steel hinge is for use on average frequency and/or medium weight wood or metal doors in schools, hospitals, and other public buildings where medium traffic is experienced and it is necessary to open the door around a large reveal. Full mortise only on jambs and doors. Stocked in USP (Prime Coat).

2 each per ctn.

Code	Finish	Size	List/ea
WTBB1279-P-3.5X5	Prime	3.5" x 5"	\$ 51.83
WTBB1279-P-4X6	Prime	4" x 6"	61.67
WTBB1279-P-4.5X6	Prime	4.5" x 6"	76.33

(Other sizes and finishes are available special order)

## HEAVY DUTY DOOR HINGES

### FULL MORTISE BALL-BEARING HINGE

#### All Special Order



Heavy Weight

McKinney: T4A3386  
T4A3786

Full mortise ball-bearing hinge. Extra heavy weight for use on high frequency and/or heavy wood or metal door in schools, hospitals, or other public buildings where heavy traffic prevails. 3 ea/box.

#### Solid Brass or Stainless Steel - Special Order

Code	Finish	Size	List/ea
T4A3386-26D-4.5	Dull Chrome	4.5" x 4.5"	\$ 84.77
T4A3386-10B-4.5	Oil R. Bronze	4.5" x 4.5"	96.43
T4A3386-32D-4.5	Stnls. Steel	4.5" x 4.5"	112.35
T4A3386-26D-5-4.5	Dull Chrome	5" x 4.5"	118.00
T4A3386-10B-5-4.5	Oil R. Bronze	5" x 4.5"	135.00
T4A3386-32D-5-4.5	Stnls. Steel	5" x 4.5"	127.00
T4A3386-26D-5	Dull Chrome	5" x 5"	129.00
T4A3386-10B-5	Oil R. Bronze	5" x 5"	150.00
T4A3386-32D-5	Stnls. Steel	5" x 5"	127.00

#### Plain Steel - Special Order

Code	Finish	Size	List/ea
T4A3786-26D-4.5	Dull Chrome	4.5" x 4.5"	\$ 57.00
T4A3786-10B-4.5	Oil R. Bronze	4.5" x 4.5"	67.00
T4A3786-P-4.5	Prime Coat	4.5" x 4.5"	53.00
T4A3786-26D-5-4.5	Dull Chrome	5" x 4.5"	65.00
T4A3786-10B-5-4.5	Oil R. Bronze	5" x 4.5"	77.00
T4A3786-P-5-4.5	Prime Coat	5" x 4.5"	61.00
T4A3786-26D-5	Dull Chrome	5" x 5"	65.00
T4A3786-10B-5	Oil R. Bronze	5" x 5"	86.00
T4A3786-P-5	Prime Coat	5" x 5"	61.00



## SPRING HINGES

### HAGER FULL MORTISE SPRING HINGE

Hager 1250



For automatic closing of door. Meets codes for hotels, motels, institutions and commercial buildings. Three each per box with wood and machine screws.

Code	Size	Finish	List/ea
1250-10B-4	4" x 4"	Oil R. Bronze	\$ 45.68
1250-15-4	4" x 4"	Satin Nickel	52.37
1250-26D-4	4" x 4"	Dull Chrome	40.34
1250-3-4	4" x 4"	Pol. Brass	52.37
1250-4-4	4" x 4"	Dull Brass	37.65
1250-5-4	4" x 4"	Ant. Bronze	37.65
1250-26-4	4" x 4"	Pol. Chrome	52.44
1250-10B-4.5	4.5" x 4.5"	Oil R. Bronze	59.73
1250-26D-4.5	4.5" x 4.5"	Dull Chrome	57.11
1250-15-4.5	4.5" x 4.5"	Satin Nickel	48.59
1250-26-4.5	4.5" x 4.5"	Pol. Chrome	52.83

Size	Max Door Wt.	Spring Hinge	Ball-Bearing Hinge
4" x 4"	60	1	2
	85	2	1
	110	3	-
4.5" x 4.5"	70	1	2
	115	2	1
	150	3	-

### COMMERCIAL GRADE SPRING HINGES

UL Listed



- Square Corner
- UL Listed
- 4 x 4" size: 0.133" ga.
- 4.5 x 4.5" size: 0.134" ga.

Code	Size	Finish	List/ea
H44S-00OB	4" x 4"	Oil R Bronze	\$ 21.13
H44S-00SC	4" x 4"	Satin Chrome	19.29
H44S-00SN	4" x 4"	Satin Nickel	18.38
H45S-00OB	4.5" x 4.5"	Oil R Bronze	25.36
H45S-00SC	4.5" x 4.5"	Satin Chrome	24.93

8

### EMTEK SPRING HINGES - All Special Order

Square Corner



**Plated Steel Spring Hinges** Thickness: 0.110"



95013  
3-1/2" x 3-1/2"



95014  
4" x 4"

Code	Size	List/pr
95013	3-1/2" x 3-1/2"	\$ 36
95014	4" x 4"	39

Available finishes: Polished Brass (US3), Satin Brass (US4), French Antique (US7), Oil R Bronze (US10B), Polished Nickel (US14), Satin Nickel (US15), Pewter (US15A), Flat Black (US19), Polished Chrome (US26), Med Bronze (MB), Tumbled White Bronze (TWB)

1/4" & 5/8" Radius Corner also available - call for pricing.



## PIVOT & SPRING HINGES

### McKINNEY DOUBLE ACTION SPRING BUTT HINGE



No Hanging strip required.  
Button Tips, Plated Steel.  
Non-template, non-handed.  
1 each per box with screws.

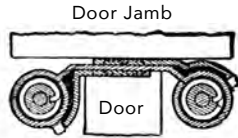

Code	Finish	Size	List/ea
1001-26D-3	Dull Chrome	3"	\$ 150
1001-26D-4	Dull Chrome	4"	150
1001-26D-5	Dull Chrome	5"	225
1001-26D-6	Dull Chrome	6"	250

### 1001 HINGE SELECTION FOR MAXIMUM DOOR SIZE

Item #	2 Hinges		3 Hinges		Door Thickness	Min Door Height
	Door Weight	Door Width	Door Weight	Door Width		
1001-3	35	2'-0"	39	2'-8"	3/4" - 1"	5'-0"
1001-4	60	2'-4"	75	3'-0"	7/8" - 1-1/4"	6'-8"
1001-5	65	2'-8"	93	3'-0"	1-1/8" - 1-1/2"	6'-8"
1001-6	75	3'-0"	107	3'-0"	1-1/4" - 1-3/4"	7'-0"

### PARKER DOUBLE ACTION SPRING HINGE



No hanging strip required.  
Adjustable spring tension.  
For door thickness of 3/4"  
to 1-1/4". Dull Brass Finish.

Packed 1 pair per box with screws.

Code	Door Weight	Size	List/pr
070-4-3	30 lbs.	3"	\$ 41.56
070-4-4	50 lbs.	4"	36.68

### McKINNEY HORIZONTAL SPRING PIVOT HINGE

Medium Duty

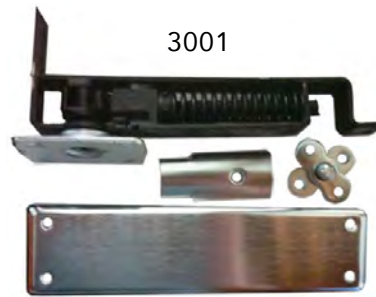

For 1-1/8" to 1-3/4" doors. Ball-bearing double action; hold open feature, will stay open at 90°, adjustable spring tension. Plated side plate hides spring. Load Cap: 90 lb/set. One set/box with screws.

Code	Finish	List/set
3001-26D	Dull Chrome	\$ 300

### DELTA DOUBLE ACTION SPRING HINGES

Solid Brass Cover Plates

The Double Action Spring Hinge is a floor-mounted self-closing hinge with solid brass cover plates and trim. It swings in both directions and has a hold open feature at approximately 90 degrees.



DASH95U10B

For 1-3/8" doors. Max load: 90 lbs. Non-handed. Available in Oil R Bronze and Satin Nickel finishes.

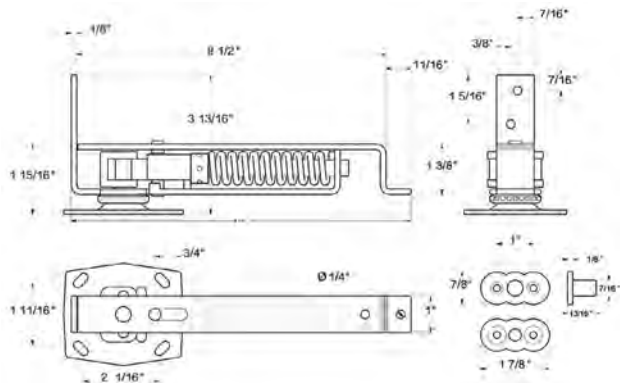

Code	Finish	List/ea
DASH95U10B	Oil R Bronze	\$ 168.84
DASH95U15	Satin Nickel	168.84



## PIVOT & SPRING HINGES

### GRAVITY PIVOT HINGE SET



60857

Double action gravity type, nylon bearing. For doors 3/4" to 1-3/4" thick, weighing 25-30 lbs. 1 pr/set. 5 sets/box.

Code	Finish	List/set
60857	Brass Plated	\$ 17.43

### STANLEY PIVOT HINGE

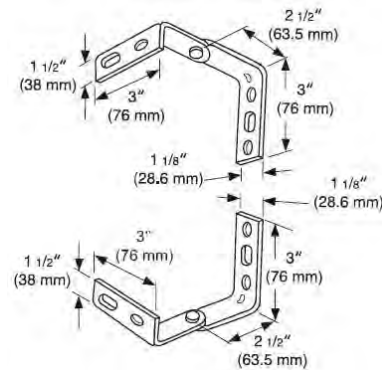

For doors up to 150 lbs. 1-3/8" to 1-3/4" thick. Ideal for plastic laminated doors and wardrobe doors. Bearings take both vertical & lateral loads. Designed for mullion mounting. Doors can be installed floor to ceiling. Made of heavy .200 gauge steel. Full 180° opening. Reversible. One right hand and one left hand hinge per set. 1 set/box with screws.

Code	Finish	List/set
327-26D	Dull Chrome	\$ 96.15

### McKINNEY EP-5 DOUBLE ACTING DOOR PIVOT

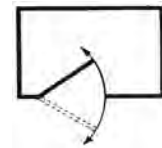

SIZE OF COMPONENTS

Bottom Door Pivot	4-3/8" x 1" x 1/4"
Header Pivot	4-1/8" x 7/8" x 1/4"
Top Door Pivot	4-1/8" x 1" x 1/4"
Bottom Jam Pivot	3" x 1-1/4" x 1/4"

Use on average frequency double acting interior doors in schools, hospitals, etc. Do not use on doors exceeding 135 lbs. Header pivot is solid brass. Top door pivot has oil impregnated porous metal bearing & rounded corners. Bottom jamb is solid brass with 1/4" vertical adjustment. Bottom door pivot has an anti-friction bearing unit & rounded corners. Pivot pt: 1-1/4" from jamb. Full mortise only on jambs and doors. 1 set/ctn.

Code	Finish	List/set
EP5J-26D	Dull Chrome	\$ 190

## FOLDING DOOR HINGES

## SOSS HINGES

### FOLDING DOOR HINGE

Spring loaded

21050 Hinge

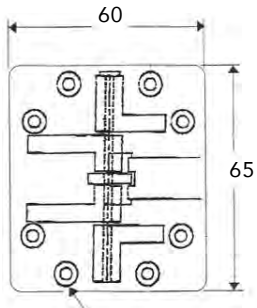

3.5x7-8 c'sink

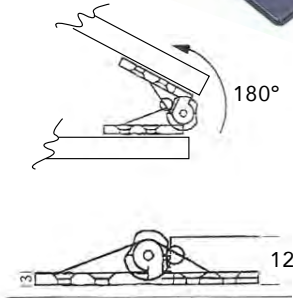

8

Flipper

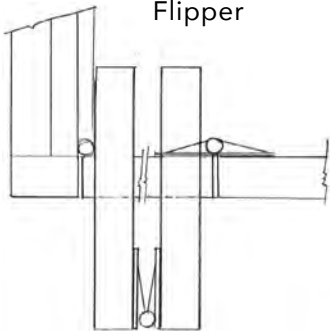

Overlay

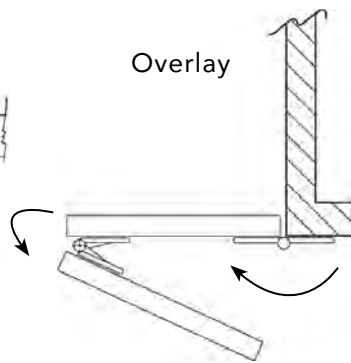

Flipper Doors Closed

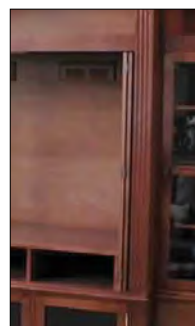

Doors Open  
w/ Flipper Door

Folding door hinge with adjustable tension. Spring loaded, door can lock in straight or folded position. Excellent for oversized entertainment center doors and flipper doors w/four doors. Sold per each.

Code	Finish	Ctn	List/ea
21050	Black	20 ea.	\$ 7.39

### SOSS INVISIBLE HINGES

Completely hidden from view when doors or lids are closed. Creates flush, smooth surfaces. Made from heavy duty rust-proof zinc alloy castings. An installing template to exact size is included w/each pair. Hinge dimensions are given for size of front plates. Dull Brass and Dull Chrome finishes available, other finishes available special order.



### For Full Size Wood/Metal Doors

1 each/box

Code	Finish	Plate Size	Min Wd Thknss	List/ea
216-	Dull Brass	1" x 4-5/8"	1-3/8"	\$ 66.11
216US26D	Dull Chrm	1" x 4-5/8"	1-3/8"	66.11
218	Dull Brass	1-1/8" x 4-5/8"	1-3/4"	72.49
218US26D	Dull Chrm	1-1/8" x 4-5/8"	1-3/4"	69.85
220C	Dull Brass	1-3/8" x 5-1/2"	2"	115.64
220US26D	Dull Chrm	1-3/8" x 5-1/2"	2"	115.64

### SOSS HINGE ROUTER GUIDE TEMPLATES



Installation of SOSS hinges has never been easier or faster. A perfect routed outline is foolproof, you can expect a perfect installation every time.

All List for \$ 59 ea.

Code	For Hinge	Code	For Hinge
101-IT	101	212-IT	212
103-IT	103	216-IT	216
203-IT	203	218-IT	218
204-IT	204	220-IT	220
208-IT	208		

### Needed with SOSS Hinge Templates:

Code	Description	List/ea
42024	3/4" template guide	\$ 13.35
42237	Locknut for template guides	7.79

**Choose the right Soss hinges.  
 See Chart next page.**

# SOSS HINGES

## SOSS INVISIBLE HINGES - CHOOSING THE RIGHT HINGE

Directions: After determining the weight and width of the door, locate the value on the two scales and connect with a straight line that continues to line "A". Draw a line perpendicular to the rules in the table until you reach the proper wood thickness. Use the number and size indicated on this line.

Example: A wood door 30" wide, 200 lbs, with a thickness of 1-3/4" will require four #218 SOSS Invisible Hinges. The red line shows how the sizing and selection were determined from the nomograph.

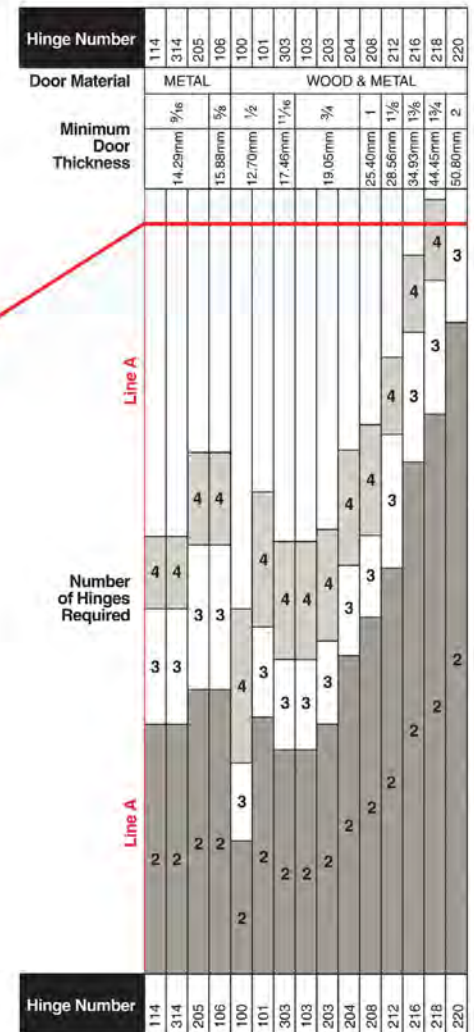
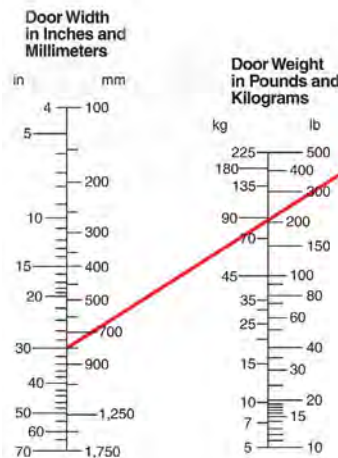

Typical Path and Clearance for Hinged Door when fully opened

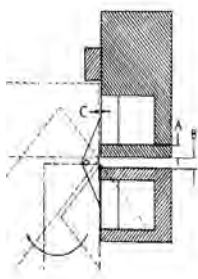

HINGE NO.	A		B		C	
	INCH	MM	INCH	MM	INCH	MM
101	3/32	2.4	7/64	2.78	1/32	0.8
103	1/8	3.2	1/8	3.18	1/32	0.8
303	1/8	3.2	1/8	3.18	1/32	0.8
314	6/32	4.0	1/8	3.16	3/32	2.4
203	1/8	3.2	7/64	2.78	1/32	0.8
204	1/8	3.2	7/64	2.78	1/16	1.6
206	5/32	4.0	9/64	3.57	3/64	1.2
212	3/16	4.8	6/32	3.97	3/64	1.2
216	1/4	6.4	7/32	5.66	1/16	1.6
218	1/4	6.4	3/8	9.53	3/64	1.2
220	9/32	7.1	1/2	12.7	1/16	1.6

Selector chart based on theoretical values. For extreme conditions consult factory.

### Recommended Spacing:

Notice in the illustration showing three hinges, that the "center" hinge is not shown in the usual location near the center of the door. The "center" hinge should be located one-half the distance from the horizontal center line of the door to the center line of the top hinge.

On installations requiring four SOSS hinges, the second hinge from the top should be located one half the distance from the doors horizontal center line to the center line of the top hinge. The third hinge from the top should be located one-quarter of the "A" dimension below the horizontal centerline of the door.

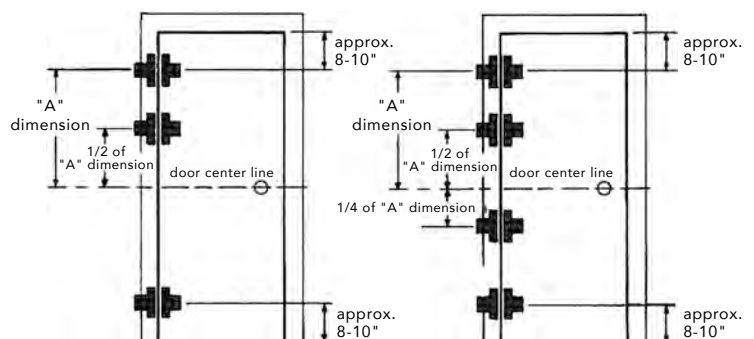



# ADJUSTABLE CONCEALED HINGES



## SIMONSWERK TECTUS 3-WAY ADJUSTABLE HINGES

Superior Clearance, Geometry, and Ease of Adjustment. Non-handed, up to 180° opening angle.

**TE-240-3D / 88 lbs/pr.**

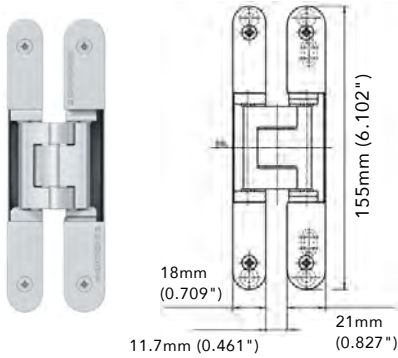

For 1" Door Min.

**3D Adjustment:**

Side +/- 3.0mm (0.118"),  
Height +/- 3.0mm (0.118"),  
Compression +/- 1.5mm (0.059").

**TE-340-3D / 176 lbs/pr.**

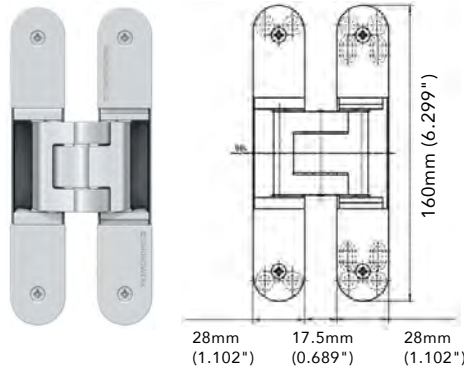

For 1-3/8" Door Min.

**3D Adjustment:**

Side +/- 3.0mm (0.118"),  
Height +/- 3.0mm (0.118"),  
Compression +/- 1.0mm (0.039").

**TE-540-3D / 264 lbs/pr.**

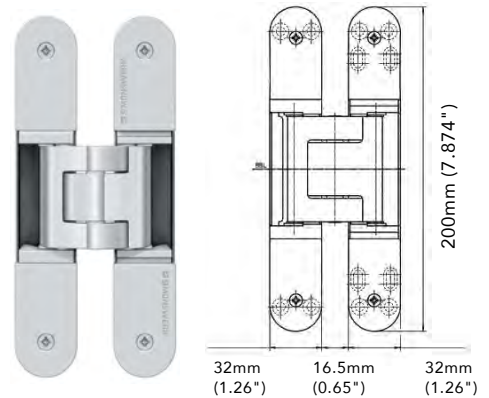

For 1-3/4" Door Min.

**3D Adjustment:**

Side +/- 3.0mm (0.118"),  
Height +/- 3.0mm (0.118"),  
Compression +/- 1.0mm (0.039").

**TE-541-3D-FVZ**  
220 lbs/pr.

For doors with frames recessed up to .55" (14mm) from the face of the door leaf.

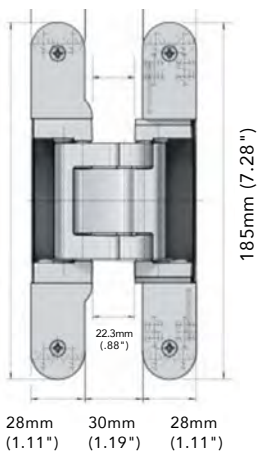

For 1-5/8" Door Min.

**TE-540-3D A8 / 200 lbs/pr.**  
For doors with claddings of up to 8mm (.315")

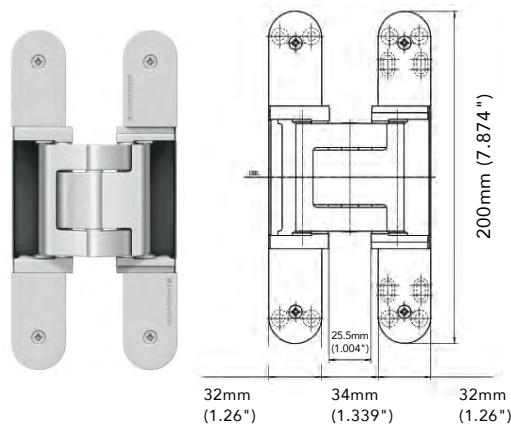

For 1-7/8" Door Min.

**3D Adjustment:**

Side +/- 3.0mm (0.118"),  
Height +/- 3.0mm (0.118"),  
Compression +/- 1.0mm (0.039").

**TE-640-3D / 440 lbs/pr.**  
For high performance commercial doors

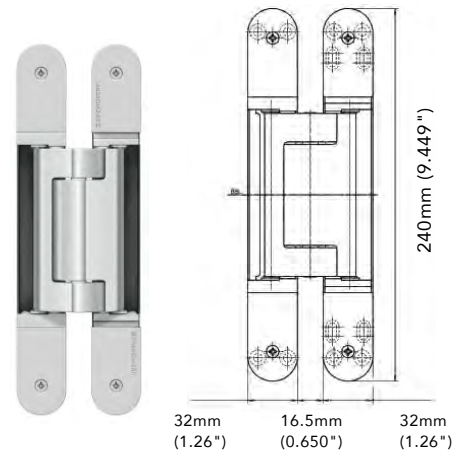

For 1-5/8" Door Min.

**3D Adjustment:**

Side +/- 3.0mm (0.118"),  
Height +/- 3.0mm (0.118"),  
Compression +/- 1.0mm (0.039").

Completely concealed for flush doors with wood, steel or alum. frames. Opening angle up to 180°, non-handed. Load Cap. refers to 2 hinges per door leaf. Maintenance free bearings. See next page for stock #s, finish choices and pricing.



## TECTUS

## ADJUSTABLE CONCEALED HINGES

### SIMONSWERK TECTUS 3-WAY ADJUSTABLE HINGES *Cont.* Finish Options, Routing Templates

#### TE-240-3D - 88 lbs/ 2 hinges. Sold per Each.

Code	Finish	List/ea
TE-240-3D-F1	Satin Chrome Look	\$ 119.72
TE-240-3D-F2	Satin Nickel Look	116.20
TE-240-3D-SSL	Stainless Steel Look	146.85
TE-240-3D-MDB	Matte Deep Black	155.09
TE-240-3D-SN	Satin Nickel	219.73
TE-240-3D-UMBER	Rustic Umber	146.85

#### TE-340-3D - 176 lbs/ 2 hinges. Sold per Each.

TE-340-3D-F1	Satin Chrome Look	\$ 134.68
TE-340-3D-F2	Satin Nickel Look	134.64
TE-340-3D-SSL	Stainless Steel Look	165.86
TE-340-3D-PNI	Polished Nickel	244.95
TE-340-3D-SN	Satin Nickel	244.95
TE-340-3D-MDB	Matte Deep Black	165.86
TE-340-3D-UMBER	Rustic Umber	165.86

#### TE-540-3D - 264 lbs/ 2 hinges. Sold per Each.

TE-540-3D-F1	Satin Chrome Look	\$ 219.73
TE-540-3D-F2	Satin Nickel Look	219.73
TE-540-3D-SSL	Stainless Steel Look	287.27
TE-540-3D-SN	Satin Nickel	404.60
TE-540-3D-UMBER	Rustic Umber	289.10

#### TE-540-3D-A8 - 200 lbs/ 2 hinges. Sold per Each.

TE-540-3D-A8-F1	Satin Chrome Look	\$ 237.71
TE-540-3D-A8-F2	Satin Nickel Look	237.71
TE-540-3D-A8-SSL	Stainless Steel Look	303.20
TE-540-3D-A8-MDB	Matte Deep Black	303.20
TE-540-3D-A8-SN	Satin Nickel	423.63
TE-540-3D-A8-UMBER	Rustic Umber	302.01

#### TE-541-3D-FVZ - 220 lbs/ 2 hinges. Sold per Each.

TE-541-3D-FVZ-F1	Satin Chrome Look	\$ 266.21
------------------	-------------------	-----------

#### TE-640-3D - 440 lbs/ 2 hinges. Sold per Each.

TE-640-3D-F1	Satin Chrome Look	\$ 292.63
TE-640-3D-F2	Satin Nickel Look	292.63
TE-640-3D-SSL	Stainless Steel Look	382.67



#### ROUTING TEMPLATES

<u>For 240 Hinge</u>	<u>Description</u>	<u>List/ea</u>
RT-DOOR-240	Routing Template, Door	\$ 108.57
RT-FRAME-240	Routing Template, Frame	97.81

<u>For 340 Hinge</u>		
RT-DOOR-340	Routing Template, Door	91.29
RT-FRAME-340	Routing Template, Frame	91.29

<u>For 540 Hinge</u>		
RT-540-S1	For TE-540, Step 1	91.29
RT-540-S2	For TE-540, Step 2	91.29
RT-540-A8-S3	For TE-540-A8, Step 3	91.29

<u>For 541 Hinge</u>		
RT-541-S1	For TE-541, Step 1	78.25
RT-541-S2	For TE-541, Step 2	78.25
RT-541-DOOR-S3	Door Template, Step 3	78.25
RT-541-FRAME-S3	Frame Template, Step 3	78.25

<u>For 640 Hinge</u>		
RT-640-S1	For TE-640, Step 1	91.29
RT-640-S2	For TE-640, Step 2	91.29

#### Powder Coated Finishes



F1 / Satin Chrome Look



F2 / Satin Nickel Look



UMBER / Rustic Umber



MDB / Matte Deep Black

#### Plated Finishes



SN / Satin Nickel



PNI / Polished Nickel

#### Galvanic/Liquid Coated



SSL / Stainless Steel Look

(Rated "warmer" in color than F1 or F2, almost "champagne")

## TECTUS

### UNIVERSAL MILLING FRAME

Jig for Routing Templates



Precise routings can be conducted for a certain hinge using the corresponding routing template.

Makes door prep fast and easy. Jig clamps to door or frame to hold templates in perfect alignment.



TE-JIG

### Complete jig consists of:

1 universal frame and 1 clamping device

### Fitting instructions:

1. Secure the clamping device to the routing frame using the clamp rods.
2. Roughly adjust the clamping device according to rebate construction and fix in place with fastening screws.
3. Clamp routing frame to workpiece with clamping wheel.
4. Insert template and roughly adjust using the standard values given for rail and angle.
5. Carry out fine adjustment using spindles.

Code	Description	List/ea
TE-JIG	Universal Milling Frame	\$ 643.84

### Recommended bit & collet:

- 45441: Plunge bit 3/4" x 2"  
 42030: 1" collet



Scan here for Video  
 Or, go to [macpac1.com/videos.html#simonswerk](http://macpac1.com/videos.html#simonswerk)

Visit [www.tectushinges.com/adjust\\_steps.html](http://www.tectushinges.com/adjust_steps.html) for an active look at Tectus 3D adjustments - step by step

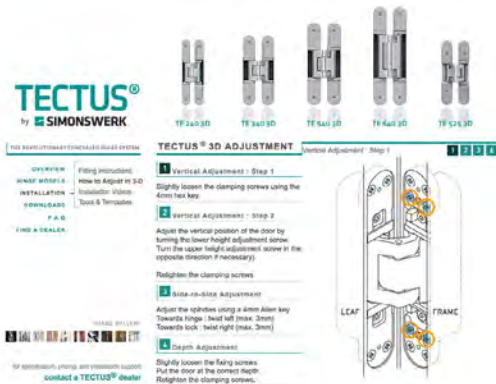

## SIMONSWERK

### FIXING PLATE FOR TECTUS SERIES HINGES

For reinforcement of wood casing frames of pre-hung doors

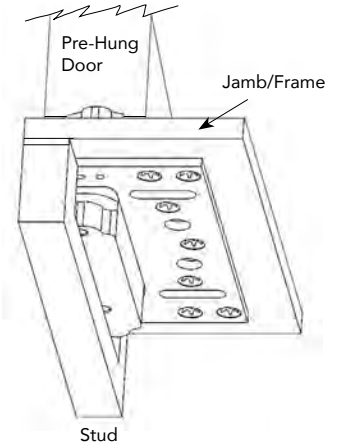

Code	Description	List/ea
TE-240-3D-FZ	Fixing Plate for casing frames for TE-240-3D	\$ 16.72
TE-340-3D-FZ	Fixing Plate for casing frames for TE-340-3D	21.09

### FRAME RECEIVER FOR METAL JAMBS

Use with TE-340-3D hinges

- For unrebrated residential and heavy-duty doors with steel frames
- Galvanized finish
- Non-handed

- Depth : 34mm (1-5/16")
- Total Height : 225mm (8-7/8")
- Width : 39.5mm (1-9/16")

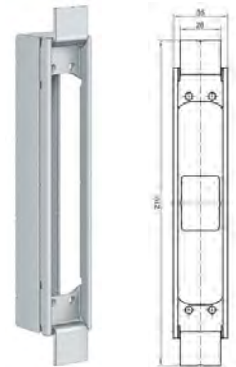

Code	Description	List/ea
TE-340-3D-SZ	Frame Receiver for TE-340 hinges	\$ 39.28



# ADJUSTABLE CONCEALED HINGES

## 3-WAY ADJUSTABLE CONCEALED HINGES

For Residential, Interior doors

For 1-3/8 to 1-3/4" Door thicknesses on **Interior Doors**

- Completely concealed hinge system for wood frames
- For flush, interior residential doors
- Easily 3D adjustable (side, height, compression)
- Load cap: 132 lbs. per pair

**AN-170-3D**  
132 lbs/pr.



AN-170-3D-AL  
Alum. Chrome



AN-170-3D-BLACK  
Black



AN-170-3D-SN  
Satin Nickel



AN-170-3D-UMBER  
Rustic Umber



AN-170-3D-WHITE  
Traffic White

Code	Finish	List/ea
AN-170-3D-AL	Alum. Chrome	\$ 55.61
AN-170-3D-BLACK	Black	55.61
AN-170-3D-SN	Satin Nickel	55.61
AN-170-3D-UMBER	Rustic Umber	55.61
AN-170-3D-WHITE	White	55.66

**Routing Template** for AN-170-3D hinges.  
Fits Universal Milling Frame (TE-JIG).

AN-170-TP                      List \$ 105.20 /ea.



**Fixing Plate** for AN-170-3D hinges for residential doors with casing frames.  
Shims and screws (M5 x 20) are included.

AN-140-3D-FZ                      List \$ 15.17 /ea.



## TECHNICAL DATA AN-170-3D

overall length	110.0 mm	(132 lbs.)
width (frame)	24.0 mm	(4.331")
width (door)	24.0 mm	(0.945")
cutter diameter	14.0 or 16.0 mm	(0.945")
collaring diameter	25.0 or 27.0 mm	(1/2") use #45426 router bit
opening angle	180°	(1") use #42030 router template guide

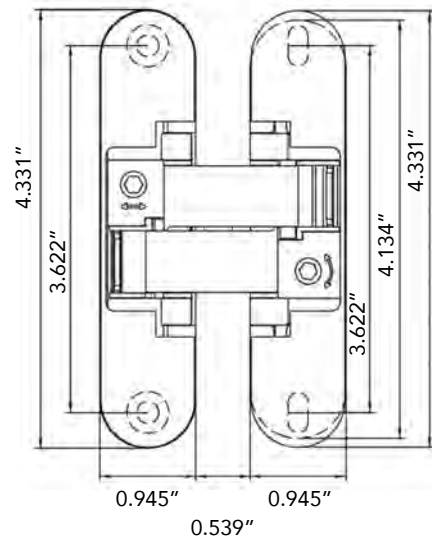

### Three way adjustable

*** Side	+/- 1.5mm (0.059")
** Height	+/- 2.5mm (0.098")
* Compression	+/- 1.0mm (0.039")

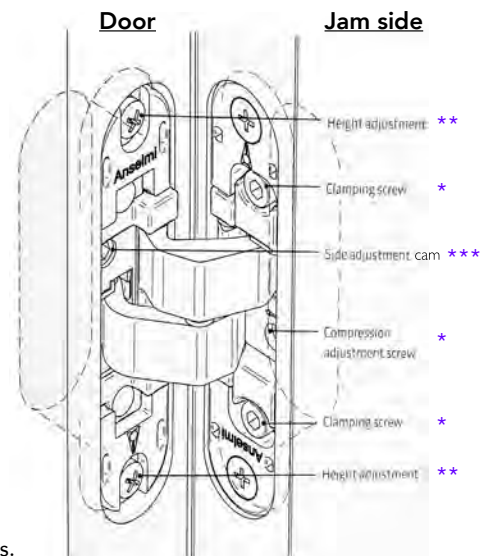

All adjustments can be performed with a 4mm (0.157") Allen wrench.

See page 1906 for 4mm hex screwdrivers.

## ADJUSTABLE CONCEALED HINGES

### AN-161 ADJUSTABLE CONCEALED HINGES

For Residential Interior doors with recessed frame facings

### AN-161-3D-FVZ

132 lbs/pr. For recessed frame facings

- Up to 0.551" (14mm) recessed frame facing
- Minimum door thickness: 1.575" (40mm)
- For wood and aluminum frames
- Easy 3D adjustable (side, height, compression)
- Load cap: 132 lbs. per pair
- Opening angle up to 180 degrees

Code	Finish	List/ea
AN-161-3D-FVZ-SN	Sat Nickel	\$ 111.63
AN-161-3D-FVZ-BLACK	Black	111.63



AN-161-3D-FVZ-SN

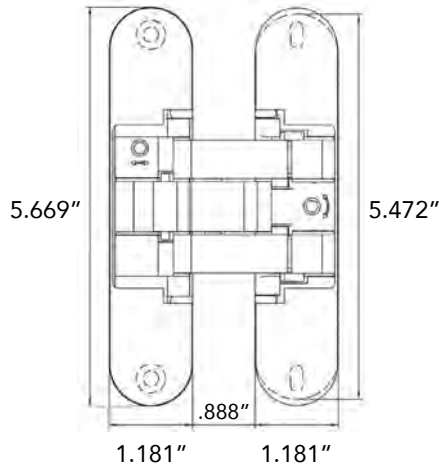

8

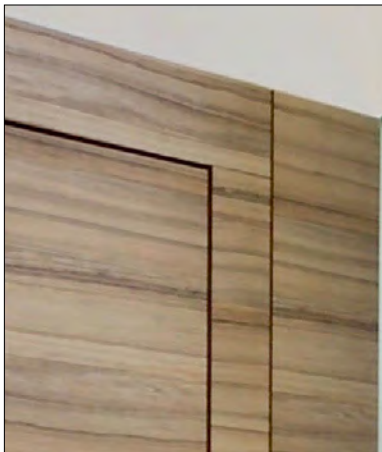

Example of a recessed frame facing

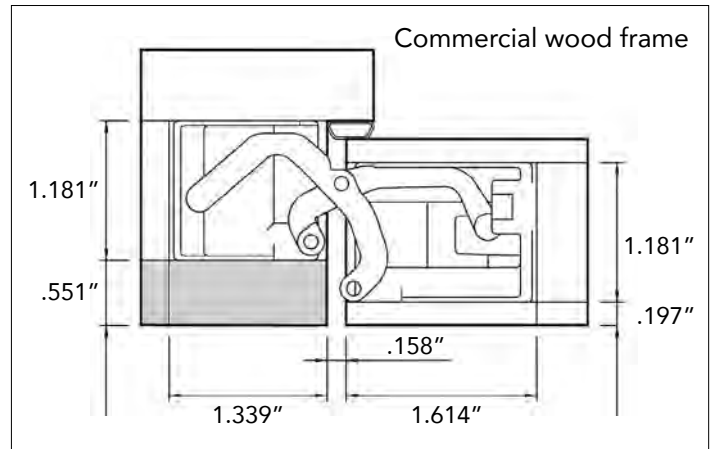

### TEMPLATES

**Both Routing Templates** are needed for AN-161-3D hinges. Fits Universal Milling Frame.

AN-161-TP List \$ 111.21/ea

AN-170-TP List \$ 105.20/ea

# ADJUSTABLE CONCEALED HINGES



## 3-WAY ADJUSTABLE CONCEALED HINGE

HES3D-120 - Load Cap: 66 lbs/ 2 hinges

For 29mm Thick Doors (1-1/8") min.



Dull Nickel

Dull Chrome

Matte Black

- 3-Way Adjustment:
  - Horizontal: -2 ~ +2mm
  - Vertical: -2.5 ~ +2.5mm
  - Depth: -1 ~ +1mm
- Max Door Weight:
  - 66 lbs/ 2 hinges
  - 88 lbs/ 3 hinges
- Min Door Thickness: 29mm (1-1/8")
- Easy Installation and adjustment
- Cover hides all screw heads for clean appearance
- Available in Dull Chrome, Dull Nickel, and Black

### Dimensions

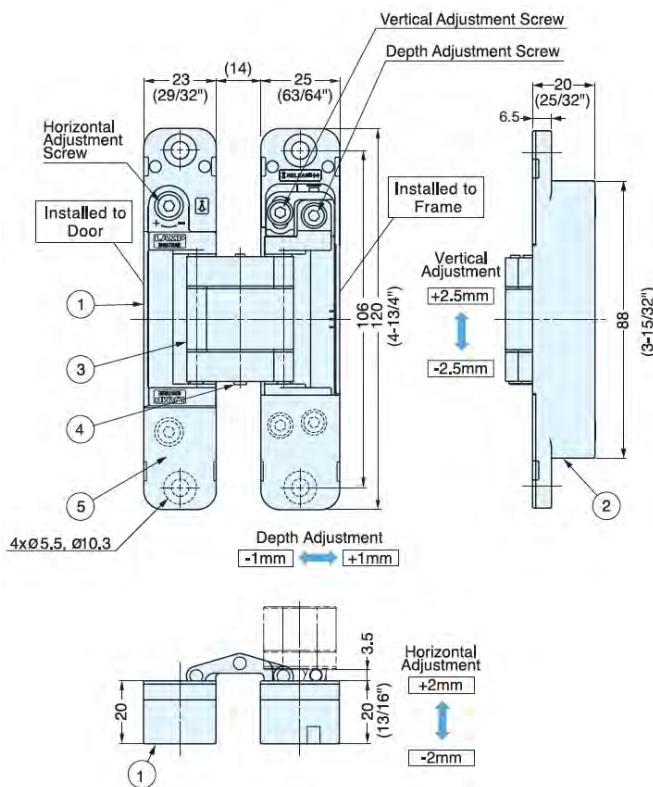

### Bore Dimensions

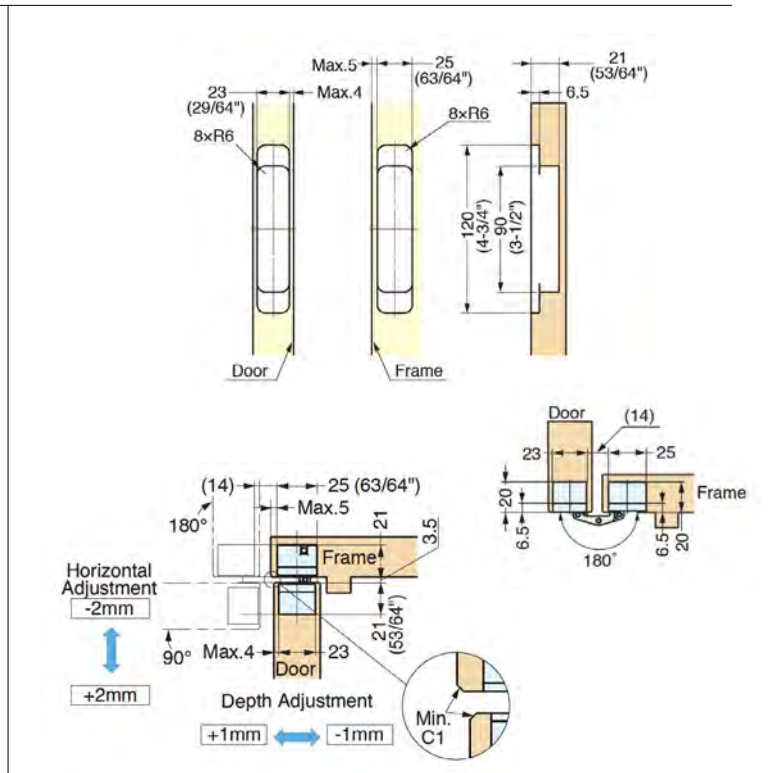

Code	Finish	List/ea
HES3D-120DC	Dull Chrome	\$ 75.83
HES3D-120DN	Dull Nickel	75.83
HES3D-120BL	Matte Black	75.83
HES3D-120-TMP	Plastic Template	90.99

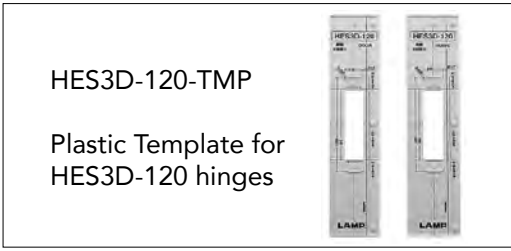



# ADJUSTABLE CONCEALED HINGES

# SUGATSUNE

## 3-WAY ADJUSTABLE CONCEALED HINGE

HES3D-E160 - Load Cap: 99 lbs/ 2 hinges



- 3-Way adjustment function allows vertical, horizontal, and depth adjustment after hinge installed
- Easy installation / removal

- Supplied with stainless steel flat head screw
- Cover hides all screw heads for clean appearance
- Door weight: Max. 99 lbs / 2 pcs, 132 lbs / 3 pcs.
- Door thickness: Min 1-3/8"
- Max. Door Size: 94-1/2" H x 35-7/16" W
- Recommended to use only 2 hinges per door for best adjustability

8

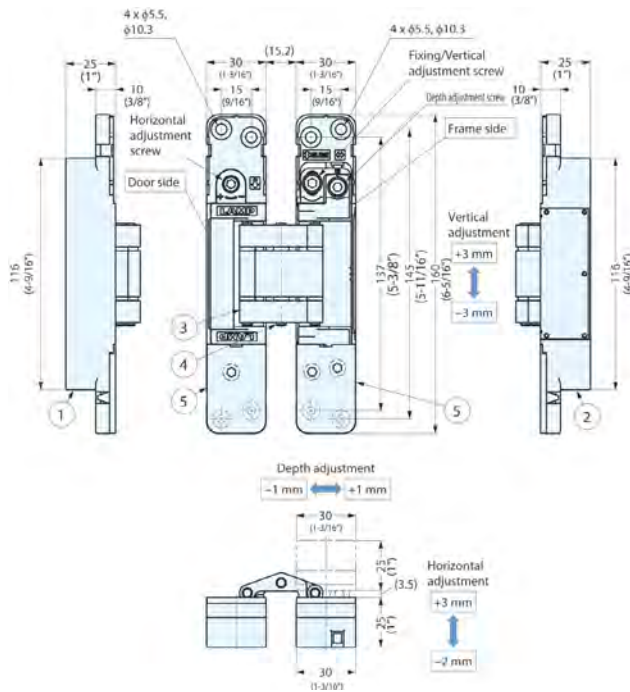

## 3-WAY ADJUSTABLE CONCEALED HINGE

HES3D-E190 - Load Cap: 220 lbs/ 2 hinges



### HES3D-E190 Economy Adjustable Hinge

- 3-Way adjustment function allows vertical, horizontal, and depth adjustment after hinge installed
- Easy installation / removal

- Successfully passed 300,000 open/close cycle tests
- Supplied with steel flat head screw
- Cover hides all screw heads for clean appearance
- Door weight: Max 220 lbs / 2 pcs, 275 lbs / 3 pcs.
- Door thickness: Min 1-1/2"
- Max Door size: 94-1/2" H x 35-7/16" W

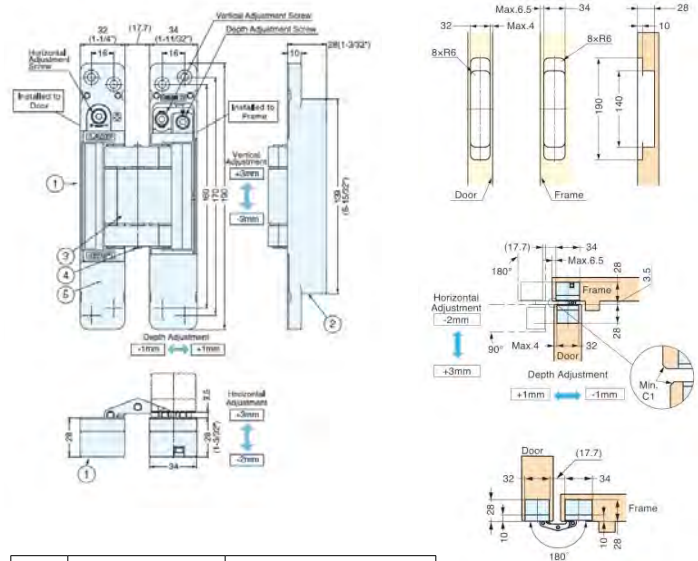

No.	Part Name	Material
1	Body	Zinc Alloy
2	Base Frame	Zinc Alloy
3	Arm	Aluminum
4	Pin	304 Stainless Steel
5	Cover	ABS



Sold per each.

Code	Finish	List/ea
HES3D-E160DC	Dull Chrome	\$ 140.53
HES3D-160-TMP	Plastic Template	75.00

Sold per each.

Code	Finish	List/ea
HES3D-E190DC	Dull Chrome	\$ 140.53
HES3D-E190BL	Black	140.53
HES3D-E190DN	Dull Nickel	140.53
HES3D-E190-TMP	Plastic Template	121.32

## SUGATSUNE

## DOOR STRAIGHTENERS

### SUGATSUNE DOOR STRAIGHTENERS

Protect your doors from future warping. Prevent doors from bending, due to warpage caused by heat and humidity. Pre-installed straighteners can also correct doors experiencing warpage. Designed to be installed at the time of door manufacture, and can be used for swinging doors, sliding doors or lateral opening doors. Nickel finish.

- +/- 10mm (3/8") adjustment can be made; adjustable at the top of door with M4 allen key
- For door ht 80-96", bar must be cut to length, up to 16-1/2"
- Requires (8) #8 flathead wood screws for installation

#### Recessed Door Straightener

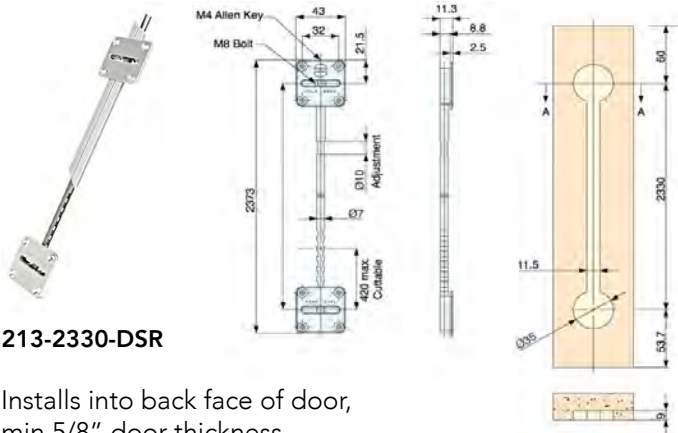

213-2330-DSR

Installs into back face of door, min 5/8" door thickness.

#### Fully Concealed Door Straightener

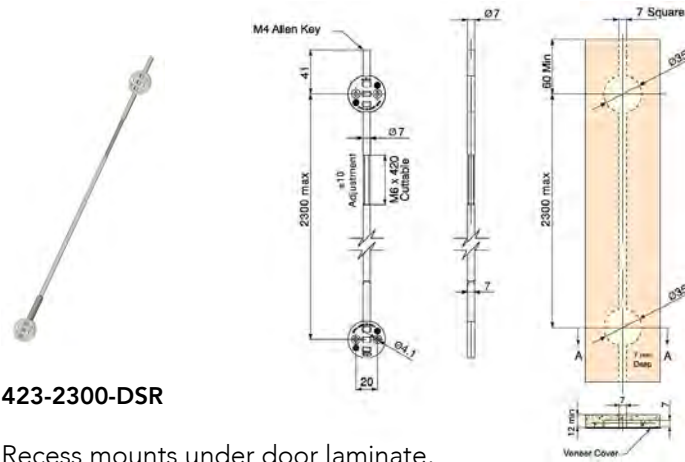

423-2300-DSR

Recess mounts under door laminate, min 1/2" door thickness.

Code	Description	List/ea
213-2330-DSR	Recessed straightener	\$ 25.00
423-2300-DSR	Concealed straightener	27.09

### SUGATSUNE DOOR STRAIGHTENERS

Full-size doors can deform with time, humidity, and use. Straighten warped doors stylishly with this door straightener kit. These braces utilize a strong steel core with durable aluminum casing to impart enough corrective force to fix bowed doors without further damage. A retrofitted solution, for post-production installation to straighten warped doors that have already lost their original shape. Available in Black and Silver finishes.

- For door heights 70-7/8" (1800mm) to 86-5/8" (2200mm)
- 5/8" Min door thickness
- +/- 10mm (3/8") adjustment can be made at the top of door with M4 allen key

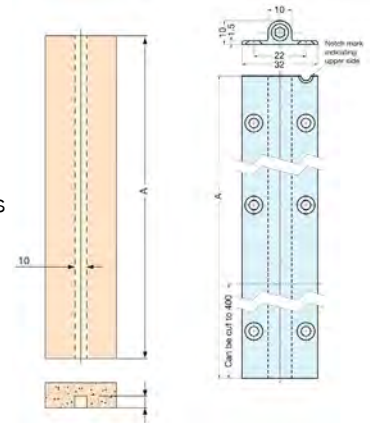

- Can be cut from the bottom up to 15-3/4" (400mm)



Code	Description	List/ea
701-2200-B	Door straightener for warped doors, Black	\$ 85.00
701-2200-S	Door straightener for warped doors, Silver	90.00

8



## GATE HARDWARE

### GRAVITY GATE LATCH

Gravity Gate Latch.  
Wrought steel with  
4-5/8" long latch bar.  
Zinc Plated.

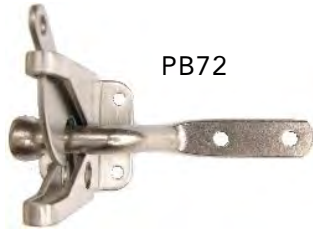

PB72

<u>Code</u>	<u>Ctn</u>	<u>List/ea</u>
PB72	20/box	\$ 5.06

### STANLEY ORNAMENTAL TEE HINGE

CD1291



CD1291

For ornamental gates in your garden or patio areas, etc. Heavy gauge steel, dull black finish is zinc plated first. Loose pin for right or left-hand application. Length of strap: 7-5/16". One pair per card with screws.

<u>Code</u>	<u>Ctn</u>	<u>List/cd</u>
CD1291	5 Cards/box	\$ 25.21

### GATE WHEEL

CGSL4

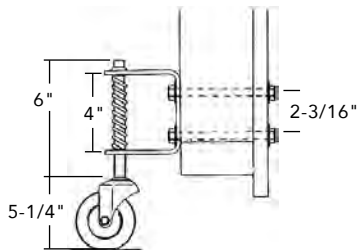

CGSL4

The Gate Wheel is ideal for uneven walkways. Helps support heavy gates. (Spring must be fully depressed to install.) Overall Ht: 11-1/4". Rubber wheel.

<u>Code</u>	<u>Load Cap</u>	<u>Wheel Dia.</u>	<u>List/ea</u>
CGSL4	240 lbs.	4"	\$ 54.35





## CREMONE BOLTS

### BALDWIN CREMONE BOLTS

Solid Brass

**ALL SPECIAL ORDER**

**Choose Knob or Lever Style to Match Entire House!**



Universal Strike



Angle Strike



Mortise Strike

**#8105  
Standard  
Design**

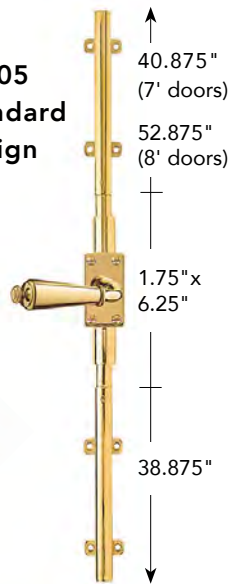

#### **Bolt Dimensions:**

Standard 7' length: Top Rod: 625" x 40.875".

Standard 8' length: Top Rod: 625" x 52.875".

Bottom Rod: .625" x 38.875" (both lengths).

**Throw:** When engaged, both bolts extend .75" into jamb and sill. All 7' Cremone Bolts are supplied with 4 guides and 8' Cremone Bolts are supplied with 6 guides. Each guide is 1-1/2" across. Ornamental covers to conceal guides are available at additional cost. Screws included.

**Strikes:** Furnished w/one ea. Universal, Angle, and Mortise strike to meet all door conditions.

**Spindle:** 1.375" (35mm) in length (#8105.004). A straight spindle must be ordered when trim is ordered for the exterior side of the door.

**Features:** Elegant design for use on a pair of French Doors with extremely narrow stile conditions.

**For Ordering:** Always specify hand of door. Always check undercut of door. Always give **EXACT** door height when ordering bolts for specific requirements.

**Knob/Lever not included.** Choose knob or lever style to match entire house. See section 300.

<u>Code</u>	<u>Description</u>	<u>List/ea</u>
8105-XXX R7LK	7' Door, RH, Less Knob/Lever	\$ 851
8105-XXX L7LK	7' Door, LH, Less Knob/Lever	851
8105-XXX R8LK	8' Door, RH, Less Knob/Lever	1104
8105-XXX L8LK	8' Door, LH, Less Knob/Lever	1104

### BALDWIN CREMONE BOLTS

Solid Brass



**#8106  
Ornamental  
Design**



**#8107  
Contemporary  
Design**

Same as the Baldwin Cremone Bolt 8105 except the guides are concealed with decorative covers. All 7' Cremone Bolts are supplied with 4 guides/covers and 8' Cremone Bolts are supplied with 6 guides/covers.

**Knob/Lever not included.** Choose a knob or lever style to match entire house. See section 300 for knob and lever selection.

<u>Code</u>	<u>Description</u>	<u>List/ea</u>
8106-XXX R7LK	7' Door, RH, Less Knob/Lever	\$ 1020
8106-XXX L7LK	7' Door, LH, Less Knob/Lever	1020
8106-XXX R8LK	8' Door, RH, Less Knob/Lever	1443
8106-XXX L8LK	8' Door, LH, Less Knob/Lever	1443
8107-XXX R7LK	7' Door, RH, Less Knob/Lever	1020
8107-XXX L7LK	7' Door, LH, Less Knob/Lever	1020
8107-XXX R8LK	8' Door, RH, Less Knob/Lever	1443
8107-XXX L8LK	8' Door, LH, Less Knob/Lever	1443

#### **Extension Rods**

These packets contain all the parts necessary to extend the top rod length of the 7' and 8' Cremone Bolts for special door situations.

8106-XXX-E24	24" Ext. Rod, Ornamental	\$ 221
8106-XXX-E48	48" Ext. Rod, Ornamental	341
8107-XXX-E24	24" Ext. Rod, Contemporary	221
8107-XXX-E48	48" Ext. Rod, Contemporary	341

## SURFACE BOLTS

### BALDWIN GENERAL PURPOSE CONCEALED SURFACE BOLT

Solid Extruded Brass

Fully concealed  
 general purpose  
 surface bolt.

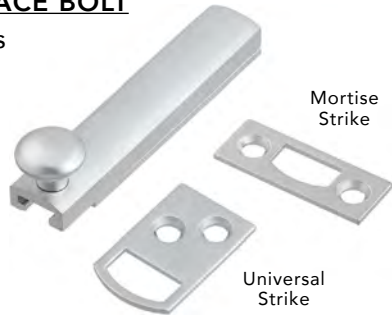

Rod Width: 1/2".  
 Guide Width: 1/2".  
 Throw: .875".

Fasteners are not visible when bolt is installed.  
 With screws, universal and mortise strikes.

Code	Size & Finish	List/ea
0321-102	3", Oil R. Bronze	\$ 36.03
0321-260	3", Polished Chrome	36.03
0321-264*	3", Dull Chrome	36.03
0321-150	3", Satin Nickel	36.03
0322-030	4", Polished Brass	\$ 37.03
0322-102	4", Oil R. Bronze	37.03
0322-260	4", Polished Chrome	37.03
0322-264*	4", Dull Chrome	37.03
0322-150	4", Satin Nickel	37.03

\*disc when out

### TRIMCO SURFACE BOLTS



Concealed screw installation. Tension spring action to hold the throw bolt solidly in position. Interlocking construction which also adds strength and durability.

Made of solid extruded brass. Width: 5/8". Supplied with mortise and rim strike. Packed 10 per box.

<u>Size: 2", Throw: 7/16"</u>		List/ea
4872-C-605	Polished Brass	\$ 15.40
4872-C-613	Oil R. Bronze	18.68
4872-C-625	Polished Chrome	20.48
4872-C-626	Dull Chrome	18.67
4872-C-619	Satin Nickel	26.29

<u>Size: 3", Throw: 5/8"</u>		List/ea
4873-C-605	Polished Brass	\$ 15.54
4873-C-609	Antique Brass	23.51
4873-C-613	Oil R. Bronze	18.45
4873-C-626	Dull Chrome	15.76

<u>Size: 4", Throw: 7/8"</u>		List/ea
4874-C-605	Polished Brass	\$ 18.95
4874-C-613	Oil R. Bronze	20.46
4874-C-625	Polished Chrome	22.74
4874-C-626	Dull Chrome	15.72
4874-C-609	Antique Brass	26.73
4874-C-619	Satin Nickel	28.55

<u>Size: 6", Throw: 1"</u>		List/ea
4876-C-605	Polished Brass	\$ 22.74
4876-C-613	Oil R. Bronze	24.76
4876-C-625	Polished Chrome	26.78
4876-C-626	Dull Chrome	18.76
4876-C-619	Sat. Nickel	34.37
4876-609	Ant. Brass	29.93

<u>Size: 12", Throw: 2-1/4"</u>		List/ea
4882-605	Polished Brass	\$ 25.40
4882-613	Oil R. Bronze	36.79

## SURFACE BOLTS

### E. MORRIS & CO. HEAVY DUTY SURFACE BOLTS

Solid Brass



Solid Brass Bolt with forged brass guides and knob.  
 Size: Width of Bolt: 0.625". Width of Guide: 1.625"  
 Diameter of Knob: 1.250".

One/box with Univ. and Mortise Strikes and Screws.

605E = Lifetime Brass, 613 = Oil R Bronze, 619 = Ant. Nickel

Code	Bolt Length	No. of Guides	605E	613/619
2108	8"	2	\$ 87.75	\$ 78.13
2112	12"	3	100.59	89.57
2118	18"	3	112.01	106.73
2124	24"	3	188.05	131.50

### BALDWIN HEAVY DUTY SURFACE BOLTS

Solid Brass \*All Special Order\*



Rod Width: .625". Guide Width: 1.75". Designed to prevent marring of rods. 1.25" dia. of knob for easier handling. One per box w/ screws and universal strike.

Special Order. Available in a variety of finishes.

Code	Length	No. of covers	List/ea
0379.XXX	6"	2	\$ 106
0380.XXX	8"	2	134
0381.XXX	12"	3	165
0382.XXX	18"	3	192
0383.XXX	24"	4	229

### TRIMCO HEAVY DUTY SURFACE BOLTS

Solid Brass



Solid brass heavy duty surface bolt is packed with screws and universal strike. Bolt Length: 8", Throw 1" - 2".

Code	Size & Finish	List/ea
3920-8-605	8", Pol. Brass	\$ 61.43

## DUTCH DOOR BOLTS

### BALDWIN HEAVY DUTY DUTCH DOOR BOLT

Solid Brass



Solid Brass. Rod Width: .624". Guide Width: 1.5", Length of bolt: 4.25" Bolt Throw: 1.125". Leaves of the doors are tightly joined by chamfered rod end. Strike opening allows for misalignment of the two leaves. 1.25" dia. knob for easier handling. 5 per box with screws & strike.

Code	Finish	List/ea
0345-102	Oil R. Bronze	\$ 110.10
0345-150	Sat. Nickel	110.10

### IDH DUTCH DOOR BOLT

Solid Brass



Chamfered rod end draws the two leaves of door tightly together. Strike opening allows for misalignment of door leaves; prevents binding of bolt. Knob is 1" diameter. With screws. Includes standard strike (1.41" x 1.08"), mortise strike (2.11" x 0.8") and screws. Pack: 5 each.

Overall Width: 1-5/8"

Rod Length: 4-1/4"

Overall Length: 4-3/8"

Projection: 1-1/8"

Throw: 5/8"

Half Round Rod: 5/8"

Code	Finish	List/ea
11270-003	Polished Brass	\$ 32.21
11270-10B	Oil Rubbed Bronze	42.91
11270-26D	Dull Chrome	42.30
11270-015	Satin Nickel	29.12



## MORTISE BOLTS

## SLIDE BOLTS

### BALDWIN MORTISE BOLTS

Solid Brass

9/16" Throw

Tubular forged brass construction. Heavy duty mortise bolt, 2.375" backset. Stainless steel housing. Smooth, positive action. Polybagged, 1 ea/box with screws.

Traditional



0419

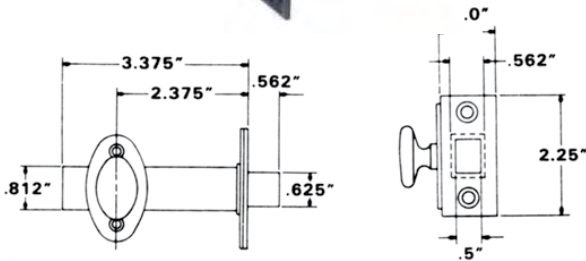

Contemporary



0418

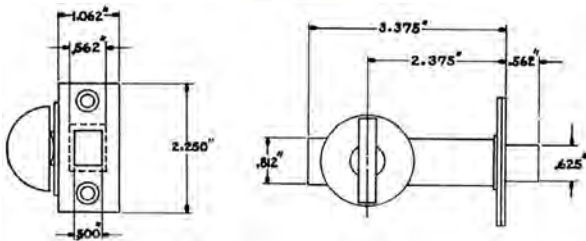

Code	Description	List/ea
0419.XXX	Traditional Mortise Bolt, 2.375" backset	\$ 113.10
0418.XXX	Contemporary Mortise Bolt, 2.375" backset	113.10
0418.XXX.LTP	Mortise Bolt, Less Turn Piece	45.04

### Emergency Release Trim & Key Set

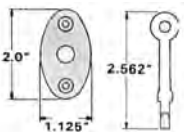

0416

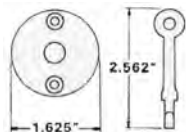

0415

0416.XXX	use with 0419 bolt	\$ 62.06
0415.XXX	use with 0418 bolt	62.06

### SUGATSUNE SLIDE BOLT

KR-50

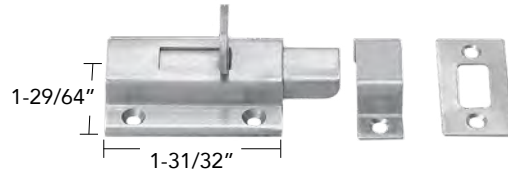

Supplied with mortise and surface strikes. Satin stainless steel. Light duty.

Code	Description	Ctn	List/ea
KR-50	Slide Bolt	20	\$ 15.06

### SUGATSUNE SPRING LOADED BARREL BOLT

BL-SS & BLS Series

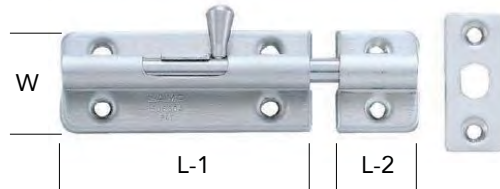

Spring Loaded Barrel Bolt is supplied with mortise and surface strikes. Knob springs back into sleeve to keep bolt in locked or unlocked position. Satin Stainless Steel.

Code	W	L-1	L-2	List/ea
BL-40SS	.94"	1-37/64"	.80"	\$ 18.40
BL-60SS	.94"	2-23/64"	.80"	20.12
BLS-60	1-19/64"	2-23/64"	1"	32.25

### BARREL BOLT



3". Carded.  
10 cards per box.

Code	Finish	Size	List/ea
06031	Zinc Plated	3"	\$ 4.02



## SASH LIFTS

### BAR SASH LIFT

Ives

3-7/16" C/C,  
4" long, Aluminum.



<u>Code</u>	<u>Finish</u>	<u>Ctn</u>	<u>List/ea</u>
SP026A3	Bright Brass	25 ea.	\$ 2.95
SP026A92	Nat. Aluminum	25	1.99
SP026A5	Antique Brass	25	2.63
026AW	White	20	3.37

### BALDWIN SASH LIFT

Solid Brass



Solid Forged Brass Sash Lift. Size: 4" x 1.125",  
Projection: 1". With screws.

<u>Code</u>	<u>Finish</u>	<u>List/ea</u>
0470-050	Satin Brass/Blk	\$ 28.02
0470-102	Oil R. Bronze	28.02
0470-150	Satin Nickel	28.02
0470-260	Polished Chrome	28.02

### IDH BAR SASH LIFT

Solid Brass



4" overall, 3.5" C/C, Projection" 1".  
Solid Brass. Polybagged 10 per box.

<u>Code</u>	<u>Finish</u>	<u>List/ea</u>
25042-003	Polished Brass	\$ 14.18
25042-10B	Oil R. Bronze	12.68
25042-026	Polished Chrome	10.93
25042-015	Satin Nickel	12.68
25042-005	Antique Brass	12.04

### IDH HOOK SASH LIFT

Wrought Solid Brass



Width: 1-5/8",  
Projection: 3/4". Solid Brass.  
10 each/box with screws.

<u>Code</u>	<u>Finish</u>	<u>List/ea</u>
21066-003	Polished Brass	\$ 6.61
21066-015	Satin Nickel	7.35
21066-026	Polished Chrome	8.01
21066-10B	Oil R. Bronze	8.01
21066-005	Antique Brass	7.38

### IDH HEAVY DUTY HOOK SASH LIFT

Cast Solid Brass



Premium Quality

Width: 1-3/4", Projection: 1-1/16". Cast Solid Brass.  
20 each/box with screws.

<u>Code</u>	<u>Finish</u>	<u>List/ea</u>
21051-003	Polished Brass	\$ 15.18
21051-005	Antique Brass	12.64
21051-015	Satin Nickel	18.58
21051-026	Polished Chrome	14.42
21051-10B	Oil R. Bronze	13.68

### STANLEY HOOK SASH LIFT

Wrought Steel



Width: 1-5/8" x 13/16" plate size, Hook projection:  
3/4". 2 each per card with screws.

<u>Code</u>	<u>Finish</u>	<u>Ctn</u>	<u>List/cd</u>
CD486	Dull Brass	25 cds.	\$ 7.06

## SASH HARDWARE

### BALDWIN SASH LOCK

Solid Brass



Traditional style with heavy duty spring to provide constant tension for a non-rattling fit.

Latch Base: .97" x 2.44". Strike Base: .66" x 2.44",  
 CTC of holes: 2". 10 ea. per box with fasteners.

Code	Finish	List/ea
0452-003	Polished Brass, Lifetime	\$ 25.02
0452-056	Satin Nickel, Lifetime	25.02
0452-050	Sat. Brass/Black	25.02
0452-260	Polished Chrome	25.02
0452-102	Oil R. Bronze	25.02
0452-150*	Satin Nickel	25.02

\*disc when out

### IDH SASH LOCK

Solid Brass



Solid Brass. Crescent type sash lock.

Base: 15/16" x 2-5/8", Strike: 5/8" x 2-5/8"

Code	Finish	Ctn	List/ea
21020-003	Pol. Brass	10 ea.	\$ 25.90
21020-026	Pol. Chrome	10	28.42
21020-10B	Oil R. Bronze	10	28.61
21020-015	Sat. Nickel	10	29.15
21020-005	Ant. Brass	10	28.61

### IVES SASH LOCK

Aluminum



Aluminum crescent type sash fastener.

Base: 15/16" x 2-5/8". Strike: 5/8" x 2-5/8".

("SP" Indicates Slim Pak, an easy-access box.)

Code	Finish	Ctn	List/ea
SP07A3	Pol. Brass	25 ea.	\$ 3.82
SP07A5	Ant. Brass	25	5.32
SP07A92	Aluminum	25	4.05
07AW	White Epoxy	20	6.02

## CASEMENT FASTENERS

### IDH CASEMENT FASTENERS

Solid Brass

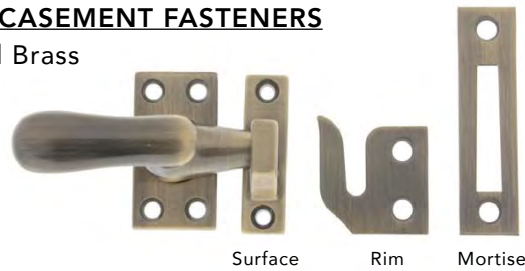

Solid Brass casement fasteners. Includes three strikes: surface, rim, and mortise. Polybagged 10 ea/box with screws. Two sizes available.

**Base Size: 1-5/8" x 7/8", Projection: 1-3/8"**

Code	Finish	List/ea
21013-10B	Oil R. Bronze	\$ 30.71
21013-015	Sat. Nickel	30.71
21013-026	Pol. Chrome	29.88
21013-003	Pol. Brass	25.84
21013-005	Antique Brass	31.27

**Base size: 2-1/16" x 1-1/16", Projection: 1-7/8"**

Code	Finish	List/ea
21014-10B	Oil R. Bronze	\$ 50.89
21014-015	Sat. Nickel	50.81
21014-026	Pol. Chrome	50.69
21014-003	Pol. Brass	35.72
21014-005	Antique Brass	50.89

### IVES CASEMENT FASTENERS

Burnished Cast Aluminum



Packed with rim and mortise strike.  
 Base: 1-5/8" x 7/8", Proj: 1-3/8".  
 ("SP" indicates slim-pak, an easy-access box.)



Code	Finish	Ctn	List/ea
SP066A92	Aluminum	15 ea.	\$ 6.93
066A3RS/MS	Polished Brass	10	6.73

Base = 2-1/16" x 1-1/16", Proj. = 1-7/8"

Packed with rim, surface and mortise strike.

Code	Finish	Ctn	List/ea
66A92	Aluminum	10 ea.	\$ 10.56
66A3	Polished Brass	10	16.60



## SASH HARDWARE

### IDH CASEMENT

#### ADJUSTER

Solid Brass



21001

Length: 10", Dia. of Rod: 3/8",  
Sash Plate: 2-1/4" x 1", Sill Plate: 1-3/4" x 3/4".  
Solid Brass w/Screws.

Code	Finish	Ctn	List/ea
21001-10B	Oil R. Bronze	10 ea.	\$ 52.39
21001-015	Satin Nickel	10	52.55
21001-026	Polished Chrome	10	46.38
21001-003	Polished Brass	10	49.35
21001-005	Antique Brass	10	42.46

### DUPLEX ADJUSTABLE SASH BALANCE

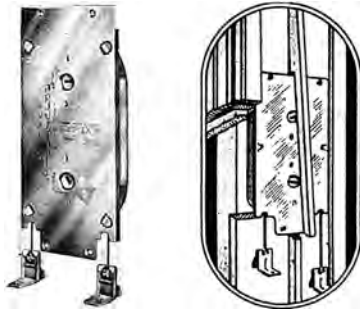

For light loads. Sash weight 4 to 8 lbs. per balance.  
30 per carton.

Code	Description	List/ea
1DU	For 4 to 8 lbs.	\$ 69.71
2DU	For 8 to 12 lbs.	79.11
D4	For 12 to 18 lbs.	120.07
5DU	For 18 to 24 lbs.	136.65

## SECURITY HARDWARE

### TRANSOM CHAIN - 12"

Plated Steel,  
12" Transom Chain.



Plate Size: 1-1/2" x 1"  
Pack: 25 ea.

Code	Finish	List/ea
TC82U3	Polished Brass	\$ 8.93
TC82U15	Satin Nickel	10.18

### IDH TRANSOM CATCH

Solid Brass.  
2-1/4" x 1-1/4".  
With Universal,  
Angle, and  
Surface strikes.  
Spring loaded.



Pack: 10 each.

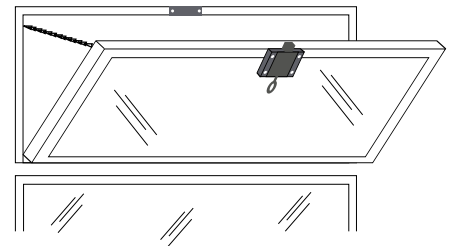

Code	Finish	List/ea
21006-003	Polished Brass	\$ 49.54
21006-015	Satin Nickel	58.64
21006-26D	Dull Chrome	58.64
21006-10B	Oil Rubbed Bronze	58.64



## CASEMENT WINDOW HARDWARE

### CASEMENT WINDOW HINGES

Drop in for Whitco Hinges



Solid  
Stainless  
Steel

Casement window sash hardware. Sold in sets (a top and a bottom for one window). Solid Stainless Steel. Drop in for Whitco hinges and hole pattern.

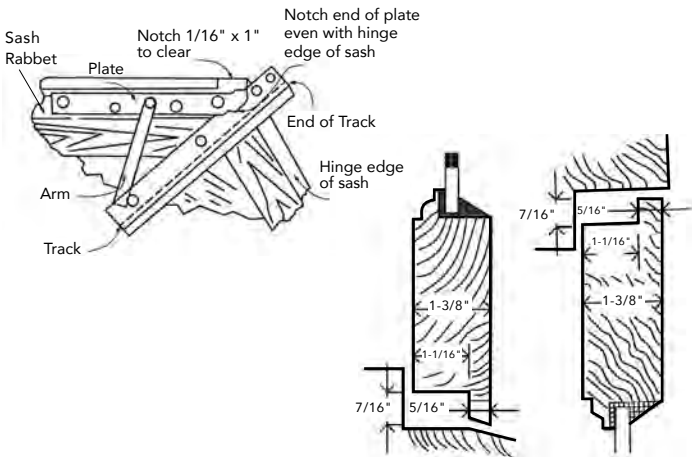
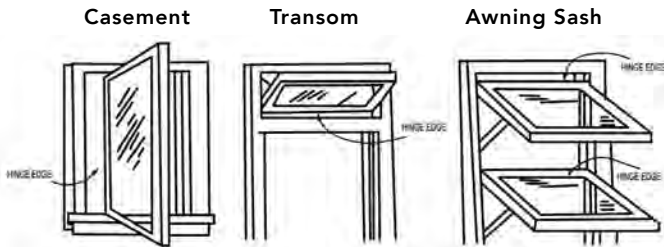

**Casement Sills**      **Casement Heads**  
or Transom and  
Awning Jambes

Code	Description	Old No.	List/st
8SS	8", Stainless Steel	8X	\$ 68.03
10SS	10", Stainless Steel	10X	75.07
12SS	12", Stainless Steel	12X	79.77
14SS	14", Stainless Steel	14X	85.23
16SS	16", Stainless Steel	16X	93.84
18SS	18", Stainless Steel	18X	109.49
16SS-HD	16", Stainless Steel, Heavy Duty	16JS	131.39





## NEOLOOP LED LIGHTS

**N1 SIDE**



Beam **110°**

Uses: Highlight millwork, outline logos & more

**N2 TOP**



Beam **145°**

Uses: Undercounter accents, soffits or toe kick lighting

### NEOLOOP SIDE OR TOP EMITTING, 12VDC, 3W/FT.



Shatterproof and watertight, Neoloop gives off a smooth continuous beam of light, without dark spots. This durable, flexible LED is cuttable and linkable. Easy to install by pressing into a routed groove, or surface mount with U-clips. Dimmable with optional dimmers. Built in diffuser seals the beam.

- Flexible silicone construction with built-in diffuser
- Dimmable
- Stocked in: Warm (3000K), Neutral (3500K) and Cool (4800K)
- 16.4' Rolls, cuttable every 1"
- Linkable with link cords and back-to-back connectors
- 79" starter cords molded on each end for easy installation
- Groove for recess mounting or surface mount with U-clips
- 50,000 hours diode life
- Max run 20' per 60W power supply
- Input Voltage: 12VDC

Specifications	Side-Emitting	Top-Emitting
Wattage	3W/ Ft.	3W/ Ft.
Lumens	100/ Ft.	200/ Ft.
Efficacy (lm/W)	33.3	66.7
Diode Life	50,000 hrs.	50,000 hrs.
Bend Radius/Axis	4" Horizontal	4" Vertical

#### Side Emitting, N1

Code	Description	List/rl
L-N1-12V3WM-30K-5M	N1, Warm Wt, 16.4'	\$ 393
L-N1-12V3WM-35K-5M	N1, Neutral Wt, 16.4'	393
L-N1-12V3WM-48K-5M	N1, Cool Wt, 16.4'	393

#### Top Emitting, N2

Code	Description	List/rl
L-N2-12V3WM-30K-5M	N2, Warm Wt, 16.4'	420
L-N2-12V3WM-35K-5M	N2, Neutral Wt, 16.4'	420
L-N2-12V3WM-48K-5M	N2, Cool Wt, 16.4'	420

#### TRANSFORMER - 60W

Max run of Neoloop from a single 60W Transformer is 20 ft. Mounting Block and Power Cord are included with each Transformer. Black. Optional Dimmer.

Code	Description	List/ea
DC-SLELT60-CON	60W 12VDC Transformer	\$ 121.93
L-N1-12PKT-2M	N1 Starter Cord*	32.58
L-N2-12PKT-2M	N2 Starter Cord*	28.14

\*Each roll comes with 2 starter cords but more will most likely be required

#### 60W HARDWIRE LED POWER SUPPLY

Dims with Wall Switch



Code	Description	List/ea
DC-E60D-CON	Dimmable Hardwire Power Supply 60W	\$ 211.51



Press into a groove for recess mounting or surface mount with U-clips.

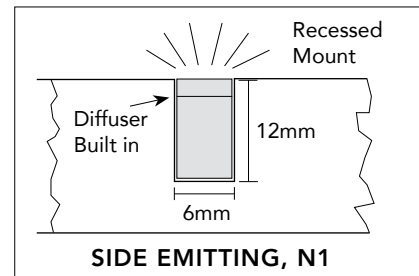

**SIDE EMITTING, N1**

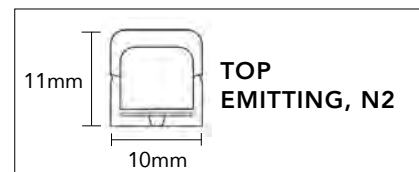

**TOP EMITTING, N2**

#### OPTIONAL ACCESSORIES

See more on pages 1008-1014

Side Emitting N1	Description	List
L-N1-LNK25	N1 Link Cord, 10"	\$ 39.13
L-N1-LNK60	N1 Link Cord, 24"	40.04
L-N1-LNK120	N1 Link Cord, 48"	45.54
L-N1-LNK180	N1 Link Cord, 72"	48.44
L-N1-BTB	Back to Back connector	15.01
L-N1-ENDCAP	End Caps	.74
L-N1-UCLP	U-Clip for surface mount	15.36

#### Top Emitting N2

L-N2-LNK25	N2 Link Cord, 10"	\$ 37.04
L-N2-LNK60	N2 Link Cord, 24"	37.90
L-N2-LNK120	N2 Link Cord, 48"	40.20
L-N2-LNK180	N2 Link Cord, 72"	42.79
L-N2-BTB	Back to Back connector	14.56
L-N2-ENDCAP	End Caps	1.44
L-N2-UCLP	U-Clip for surface mount	18.80

# FLEXTAPE LED LIGHTS



## FLEXTAPE LED LIGHTS

- Avg. rated life: 50,000 hrs
- 1.5 Watts / foot
- Sold by 4' and 20' rolls (L x 3/8" W x 1/16" H)
- Cuttable every 2" (49mm)
- Avail. in Warm, Neutral & Cool White
- Low heat
- Strong 3M adhesive backing
- Dimmer available
- Linkable
- 115° beam angle

This flexible LED tape's low profile allows use in many discreet locations. Max continuous run is 20' (6m). It has an adhesive backing for easy mounting. Sold per roll.

Applications: Cove lighting, Back lighting, Accent and Edge lighting, Toekick, Soffit  
 May be used with Infinex Aluminum Extrusions.



### REQUIRED PARTS

#### FLEXTAPE LED

Roll Size 20' or 4'.  
 Cuttable every 2".



Code	Description	List
LED-FLXTPE-WROLL	20' Warm Wht (2700K)	\$ 369
LED-FLXTPE-NROLL	20' Neutral Wht (3500K)	437
LED-FLXTPE-CROLL	20' Cool Wht (4800K)	376

#### TRANSFORMER - 60W

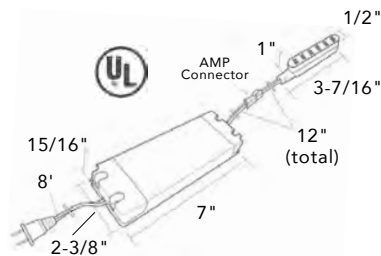

Maximum run of FlexTape from a single Transformer is 40 ft. Mounting Block and Power Cord are included with each Transformer. Black.

Code	Description	List
DC-SLELT60-CON	60W 12VDC Transformer	\$ 121.93

#### STARTER CORD

Connects each FlexTape segment to mounting block of transformer. Length: 79".



Code	Description	List
LED-TPEPKT-2M	Straight Feed	\$ 12.10
LED-TPEPKT-2M-TEE	Split Feed	21.69

### OPTIONAL ACCESSORIES

See more on pages 1008-1014

Code	Description	List
RDSW-2M-WH	Round Switch, White	\$ 24.76
RDSW-2M-BL	Round Switch, Black	25.84
LED-TPEPKT-2M-TEE	Split Feed Starter Cord	21.69
LED-DIMRMT-12V8A	LED Dedicated Remote Control Dimmer	102.83
LED-DIMRMT-12V8A-U	LED Universal Remote Control Dimmer	89.97
LED-DIMCON-WH	Manual Rotary Dimmer, Wh	58.07
LED-DIMCON-BL	Manual Rotary Dimmer, Blk	57.98
MALEAMP	Amp Connector	13.18
LED-TPELNK-TEE	Tee Connector	7.17
LED-TPELNK-CON90	Right Angle Connector	6.39
LED-TPELNK-5	Jumper Cord, 2"	6.67
LED-TPELNK-15	Jumper Cord, 6"	7.19
LED-TPELNK-25	Jumper Cord, 10"	7.93
LED-TPELNK-60	Jumper Cord, 24"	9.15
LED-TPELNK-120	Jumper Cord, 48"	9.49
LED-TPELNK-180	Jumper Cord, 72"	10.42
LED-LINKD-25	Extension Cord, 10"	7.79
LED-LINKD-60	Extension Cord, 24"	8.71
LED-LINKD-120	Extension Cord, 48"	10.60
LED-LINKD-180	Extension Cord, 72"	13.16
LED-OVLTD-NI	Dimmer Control, Nickel	51.53
LED-OVLDS-NI	Door Sensor, Nickel	49.94
L-RSMOT-NI	Motion Sensor, Nickel	55.01
XFL72-SC	72" Sat Alum Extrusion	46.87



## FLEXIBLE TAPE LED LIGHTS



### EQUILINE TAPE LED 3W LIGHTING

The low profile and flexibility of the Equiline Tape LED makes it the perfect light for displays, signs and perimeter lighting. Sold by the roll and has adhesive backing for effortless installation. 3500K Warm White. Max continuous run is 16.4' (5m). May be used with Infinex Aluminum Extrusions.

- 16.4' Rolls / Max 20' per 60W power supply
- 3W per foot, cuttable every 1"
- 3500K Warm White, Beam angle: 115°
- 12VDC input voltage
- 25,000 hour diode life



### REQUIRED PARTS

#### EQUILINE TAPE LED LIGHTS

Roll Size 16.4'.  
 Cuttable every 1".



Code	Description	List/rl
TPELED-35HER	Equiline Tape LED, 3W/ft, 3500K Warm White	\$ 270.60

#### TRANSFORMER - 60W

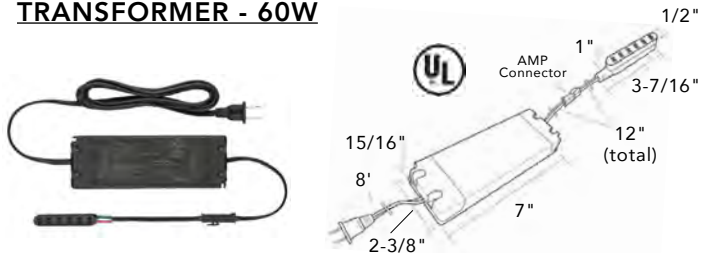

Maximum run of Tape from a single Transformer is 20 ft. Mounting Block and Power Cord are included with each Transformer. Black.

Code	Description	List
DC-SLELT60-CON	60W 12VDC Transformer	\$ 121.93

#### STARTER CORD

Connects each FlexTape segment to mounting block of transformer. Length: 79".



Code	Description	List
LED-TPEPKT-2M	Straight Feed	\$ 12.10
LED-TPEPKT-2M-TEE	Split Feed	21.69

### OPTIONAL ACCESSORIES

See more on pages 1008-1014

Code	Description	List
RDSW-2M-WH	Round Switch, White	\$ 24.76
RDSW-2M-BL	Round Switch, Black	25.84
LED-TPEPKT-2M-TEE	Split Feed Starter Cord	21.69
LED-DIMRMT-12V8A	LED Dedicated Remote Control Dimmer	102.83
LED-DIMRMT-12V8A-U	LED Universal Remote Control Dimmer	89.97
LED-DIMCON-WH	Manual Rotary Dimmer, Wh	58.07
LED-DIMCON-BL	Manual Rotary Dimmer, Blk	57.98
L-XSBTB-1	Back to Back Connector	4.69
MALEAMP	Amp Connector	13.18
LED-TPELNK-TEE	Tee Connector	7.17
LED-TPELNK-CON90	Right Angle Connector	6.39
LED-TPELNK-5	Jumper Cord, 2"	6.67
LED-TPELNK-15	Jumper Cord, 6"	7.19
LED-TPELNK-25	Jumper Cord, 10"	7.93
LED-TPELNK-60	Jumper Cord, 24"	9.15
LED-TPELNK-120	Jumper Cord, 48"	9.49
LED-TPELNK-180	Jumper Cord, 72"	10.42
LED-LINKD-25	Extension Cord, 10"	7.79
LED-LINKD-60	Extension Cord, 24"	8.71
LED-LINKD-120	Extension Cord, 48"	10.60
LED-LINKD-180	Extension Cord, 72"	13.16
LED-OVLTD-NI	Dimmer Control, Nickel	51.53
LED-OVLDS-NI	Door Sensor, Nickel	49.94
L-RSMOT-NI	Motion Sensor, Nickel	55.01
XFL72-SC	72" Sat Alum Extrusion	46.87

10

# FLEXTAPE COB LED LIGHTS



## FlexTape COB LED Lighting



Tresco Flextape COB (Chip on Board) LED lighting. Continuous coating, high density LED lighting without dark spots - no covers or filters needed! May use with Infinex Aluminum channel.

- Avg. rated diode life: 50,000 hrs
- 4.4 Watts per foot
- 13' rolls, Cuttable every 11/16" (18mm)
- Strong 3M adhesive backing
- Available in Warm, Neutral and Cool White
- Beam angle: 115°
- Max continuous run 13'

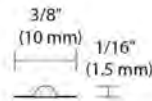
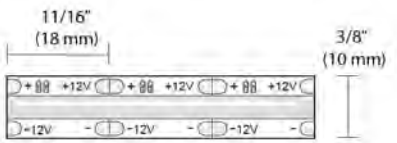

Continuous Coating -  
 No Dark Spots!



### REQUIRED PARTS

#### COB FLEXTAPE LED

Roll Size: 13', Cuttable every 11/16"

Code	Description	List/rl
L-FLXCOB12-30RV-1	Warm White, 13'	\$ 324
L-FLXCOB12-35RV-1	Neutral White, 13'	324
L-FLXCOB12-48RV-1	Cool White, 13'	324

#### TRANSFORMER - 60W

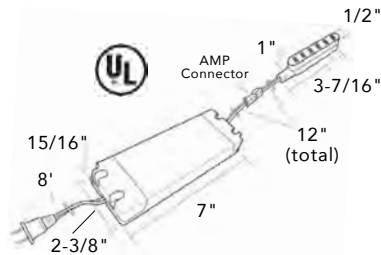

Maximum run of FlexTape from a single Transformer is 13 ft. Mounting Block and Power Cord are included with each Transformer. Black.

Code	Description	List
DC-SLELT60-CON	60W 12VDC Transformer	\$ 121.93

#### STARTER CORD

Connects each FlexTape segment to mounting block of transformer. Length: 79".



Code	Description	List
LED-TPEPKT-2M	Straight Feed	\$ 12.10
LED-TPEPKT-2M-TEE	Split Feed	21.69

### OPTIONAL ACCESSORIES

See more on pages 1008-1014

Code	Description	List
RDSW-2M-WH	Round Switch, White	\$ 24.76
RDSW-2M-BL	Round Switch, Black	25.84
LED-TPEPKT-2M-TEE	Split Feed Starter Cord	21.69
LED-DIMRMT-12V8A	LED Dedicated Remote Control Dimmer	102.83
LED-DIMRMT-12V8A-U	LED Universal Remote Control Dimmer	89.97
LED-DIMCON-WH	Manual Rotary Dimmer, Wh	58.07
LED-DIMCON-BL	Manual Rotary Dimmer, Blk	57.98
L-XSBTB-1	Back to Back Connector	4.69
MALEAMP	Amp Connector	13.18
LED-TPELNK-TEE	Tee Connector	7.17
LED-TPELNK-CON90	Right Angle Connector	6.39
LED-TPELNK-5	Jumper Cord, 2"	6.67
LED-TPELNK-15	Jumper Cord, 6"	7.19
LED-TPELNK-25	Jumper Cord, 10"	7.93
LED-TPELNK-60	Jumper Cord, 24"	9.15
LED-TPELNK-120	Jumper Cord, 48"	9.49
LED-TPELNK-180	Jumper Cord, 72"	10.42
LED-LINKD-25	Extension Cord, 10"	7.79
LED-LINKD-60	Extension Cord, 24"	8.71
LED-LINKD-120	Extension Cord, 48"	10.60
LED-LINKD-180	Extension Cord, 72"	13.16
LED-OVLTD-NI	Dimmer Control, Nickel	51.53
LED-OVLDS-NI	Door Sensor, Nickel	49.94
L-RSMOT-NI	Motion Sensor, Nickel	55.01
XFL72-SC	72" Sat Alum Extrusion	46.87



## LED PUCK LIGHTS

### 3W POWER POKKIT LED LIGHTS



The Power Pockit LED offers effective flood and task lighting in a low profile, energy-efficient package. Provides rated life of 50,000 hours. Can be used within interior cabinets, under cabinets and store displays - providing a crisp, uniform lighting. Has a frosted diffuser which eliminates glare and reflections.

- Lowest profile - 1/4" depth when recessing
- 1/2" overall thickness (surface mount)
- 120° light spread
- Warm or cool white avail.
- 79" cord, dimmer available
- Surface mount ring included
- 2-1/4" hole for recessing

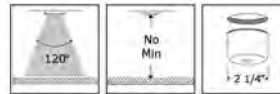

#### REQUIRED PARTS

##### 3W LED POCKET LIGHTS

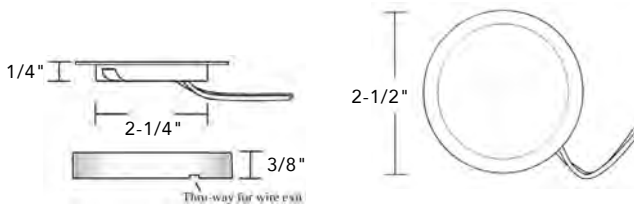

Code	Description	List/ea
POC-3LEDSFR-WWH	Warm Wht 3000K, White	\$ 101.70
POC-3LEDSFR-WBL	Warm Wht 3000K, Black	101.70
POC-3LEDSFR-WNI	Warm Wht 3000K, Nickel	101.67
POC-3LEDSFR-CBL	Cool Wht 5000K, Black	101.68
POC-3LEDSFR-CNI	Cool Wht 5000K, Nickel	101.67

Takes any ELT Transformer 6W to 60W.

##### **60W TRANSFORMER: DC-SLELT60-CON \$ 121.93**

3W - 20 lights max. Includes mounting block and 8' power cord. For an extra 6-snap mounting block order TRANS-MNT-BL). Black.

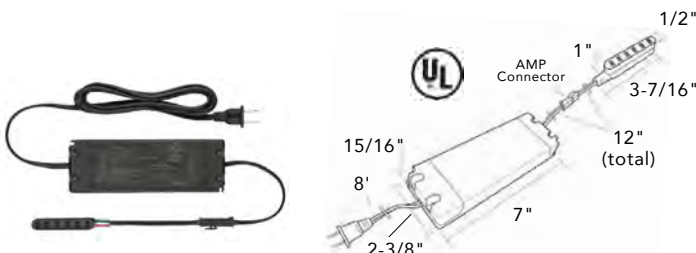

#### OPTIONAL ACCESSORIES

See more on pages 1008-1014

Code	Description	List
RDSW-2M-WH	Round Switch, White	\$ 24.76
RDSW-2M-BL	Round Switch, Black	25.84
TRANS-MNT-BL	6-Snap Mtg Block	13.71
LED-LINKD-25	Extension Cord, 10"	7.79
LED-LINKD-60	Extension Cord, 24"	8.71
LED-LINKD-120	Extension Cord, 48"	10.60
LED-LINKD-180	Extension Cord, 72"	13.16
LED-DIMRMT-12V8A	LED Dedicated Remote Control Dimmer	102.83
LED-DIMRMT-12V8A-U	LED Universal Remote Control Dimmer	89.97
LED-DIMCON-WH	Manual Rotary Dimmer, White	58.07
LED-DIMCON-BL	Manual Rotary Dimmer, Black	57.98
MALEAMP	Amp Connector	13.18
LED-OVLTD-NI	Dimmer Control, Nickel	51.53
LED-OVLDS-NI	Door Sensor, Nickel	49.94
L-RSMOT-NI	Motion Sensor, Nickel	55.01



# LED PUCK LIGHTS



## 3W EQUILINE LED PUCK LIGHTS

With recessed or surface mount ability, Equiline LED pucks are perfect for use in a wide range of applications. They feature a slim profile and a 79' starter cord, with an unattached AMP connector for easy wire routing. 25,000 hour life.

- 1/2" depth when recessing
- 1/2" overall thickness (surface mount)
- Surface mount ring sold separately
- 100° light spread
- Warm or cool white avail.
- 79" cord, dimmer available
- 2-1/4" hole for recessing



### REQUIRED PARTS

#### 3W EQUILINE LED PUCK LIGHTS

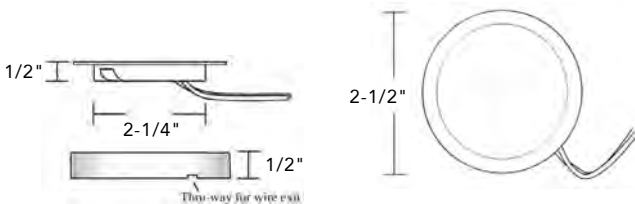

Code	Description	List/ea
POC-3EQFR-CBL	Cool Wht, 5000K, Black	\$ 41.10
POC-3EQFR-CNI	Cool Wht, 5000K, Nickel	41.10
POC-3EQFR-WBL	Warm Wht, 3000K, Black	41.18
POC-3EQFR-WNI	Warm Wht, 3000K, Nickel	41.18

Takes any ELT Transformer 6W to 60W.

#### 60W TRANSFORMER: DC-SLELT60-CON \$ 121.93

3W - 20 lights max. Includes mounting block and 8' power cord. For an extra 6-snap mounting block order TRANS-MNT-BL). Black.

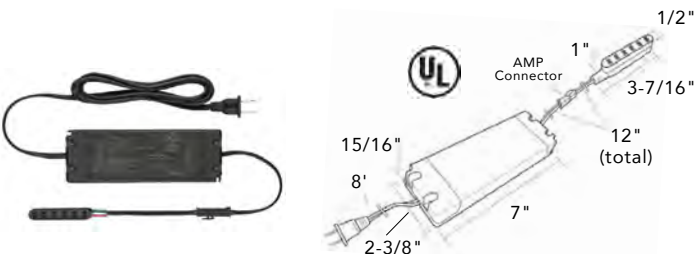

### OPTIONAL ACCESSORIES

See more on pages 1008-1014

Code	Description	List
RDSW-2M-WH	Round Switch, White	\$ 24.76
RDSW-2M-BL	Round Switch, Black	25.84
TRANS-MNT-BL	6-Snap Mtg Block	13.71
LED-LINKD-25	Extension Cord, 10"	7.79
LED-LINKD-60	Extension Cord, 24"	8.71
LED-LINKD-120	Extension Cord, 48"	10.60
LED-LINKD-180	Extension Cord, 72"	13.16
LED-DIMRMT-12V8A	LED Dedicated Remote Control Dimmer	102.83
LED-DIMRMT-12V8A-U	LED Universal Remote Control Dimmer	89.97
LED-DIMCON-WH	Manual Rotary Dimmer, White	58.07
LED-DIMCON-BL	Manual Rotary Dimmer, Black	57.98
MALEAMP	Amp Connector	13.18
LED-OVLTD-NI	Dimmer Control, Nickel	51.53
LED-OVLDS-NI	Door Sensor, Nickel	49.94
L-RSMOT-NI	Motion Sensor, Nickel	55.01



## LED STICK LIGHTS

### FINELINE 2.0 LED STICK LIGHTS



**4.4W/ ft.**

**330 Lumens per ft.**



Lunifrom output - no "dots"

Pencil thin FineLine 2.0 stick lighting. Low-profile design features a milk diffuser for even illumination. Optional manual or remote-control dimmers available. Aluminum & Nickel finish.

Available in 4 lengths, and in warm or cool temperatures. Max continuous run of 12 ft. to prevent voltage drop. Max 13 ft. per 60W power supply. 79" starter cord, AMP connector and mounting U-clips are included with each light.

12V DC, 50,000 Diode life. Surface or Recess mounting.

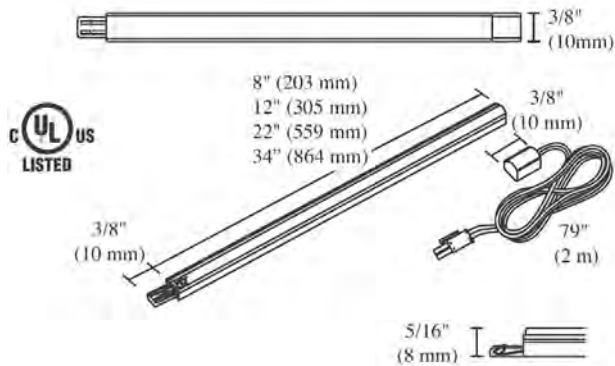

Linkable (seamless back to back or link cord) up to 12' continuous run.

#### REQUIRED PARTS

##### FineLine 2.0 LED Stick Lights

Warm White = 3000K, Cool White = 5000K

Code	Description	List
L-STKH08-WNI-1	8" Sgl Stk, Warm Wht	\$ 70.21
L-STKH08-CNI-1	8" Sgl Stk, Cool Wht	70.21
L-STKH012-WNI-1	12" Sgl Stk, Warm Wht	83.41
L-STKH012-CNI-1	12" Sgl Stk, Cool Wht	83.37
L-STKH022-WNI-1	22" Sgl Stk, Warm Wht	139.20
L-STKH022-CNI-1	22" Sgl Stk, Cool Wht	139.14
L-STKH034-WNI-1	34" Sgl Stk, Warm Wht	182.76
L-STKH034-CNI-1	34" Sgl Stk, Cool Wht	182.76

##### TRANSFORMER - 60W

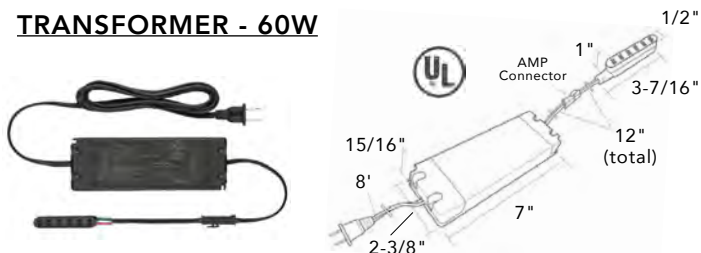

Max 13 ft per 60W power supply. Mounting Block and Power Cord are included with each Transformer. Black.

Code	Description	List
DC-SLELT60-CON	60W 12VDC Transformer	\$ 121.93

#### OPTIONAL ACCESSORIES

See more on pages 1008-1014

Code	Description	List
RDSW-2M-WH	Round Switch, White	\$ 24.76
RDSW-2M-BL	Round Switch, Black	25.84
TRANS-MNT-BL	6-Snap Mounting Block	21.69
LED-DIMRMT-12V8A	LED Dedicated Remote Control Dimmer	102.83
LED-DIMRMT-12V8A-U	LED Universal Remote Control Dimmer	89.97
LED-DIMCON-WH	Manual Rotary Dimmer, White	58.07
LED-DIMCON-BL	Manual Rotary Dimmer, Black	57.98
MALEAMP	Amp Connector	13.18
LED-OVLTD-NI	Dimmer Control, Nickel	51.53
LED-OVLDS-NI	Door Sensor, Nickel	49.94
L-RSMOT-NI	Motion Sensor, Nickel	55.01
LED-STKDIM-TD4	Inline Touch Dimmer	46.55
LED-STKLNK-5	2" Stick Linking Cord	5.61
LED-STKLNK-15	6" Stick Linking Cord	6.24
LED-STKLNK-25	10" Stick Linking Cord	6.54
LED-STKLNK-60	24" Stick Linking Cord	7.95
LED-STKLNK-120	48" Stick Linking Cord	10.77
LED-STKLNK-180	72" Stick Linking Cord	12.15

# EUROLINX



## EUROLINX LINEAR LIGHTING



EUL - Eurolinx linkable lighting

The Eurolinx flat profile blends in with any application. Using specialized diffuser and reflector technology to achieve Uniform output, this European styled light is a perfect choice for all contemporary and high-end commercial applications. Use the magnets within the U-Clips for metal shelving or office furniture mounting. Features two beam spreads based on orientation of lights. 4W per foot and over 200 lumens.

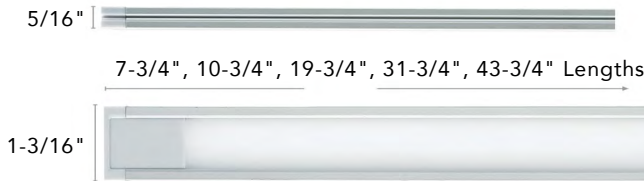

- Available in four lengths
- Linkable back-to-back up to 10' (3 m) continuous run
- Mounting clips with integrated magnets allow for metal surface mounting as well as traditional screw mount
- Optional in-line Gradual Touch Dimmer
- Sleek, contemporary European design

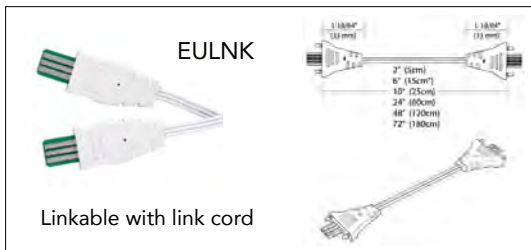

Linkable with link cord

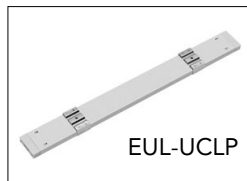

Mounting clips with integrated magnets



Optional inline gradual touch dimmer



Back-to-Back Link

### REQUIRED PARTS

Eurolinx Series 12VDC. Each light contains: 79" cord, U-Clips and a back to back connector.

Warm White = 3000K, Cool White = 5000K

Code	Description	List/ea
EUL3W-197CAL	7.75", 3W, Cool White	\$ 102.34
EUL3W-197WAL	7.75", 3W, Warm White	102.28
EUL4W-273CAL	10.75", 7W, Cool White	114.28
EUL4W-273WAL	10.75", 7W, Warm White	114.28
EUL7W-502CAL	19.75", 7W, Cool White	131.81
EUL7W-502WAL	19.75", 7W, Warm White	131.86
EUL11W-806CAL	31.75", 11W, Cool White	164.67
EUL11W-806WAL	31.75", 11W, Warm White	164.71
EUL15W-1111CAL	43.75", 15W Cool White	197.43
EUL15W-1111WAL	43.75", 15W Warm White	197.43

**60W TRANSFORMER: DC-SLELT60-CON \$ 121.93**

Includes mounting block and power cord. For an extra 6-snap mounting block order TRANS-MNT-BL. Maximum 15' per 60W power supply.

### Two Beam Spreads!!!

Powered Left Side

Powered Right Side



### OPTIONAL ACCESSORIES

Code	Description	List/ea
EULNK-15-WH	6" Link Cord, white	\$ 12.19
EULNK-25-WH	10" Link Cord, white	13.09
EULNK-60-WH	24" Link Cord, white	14.95
EULNK-120-WH	48" Link Cord, white	17.75
EULNK-180-WH	72" Link Cord, white	21.32
EULNK-BTB-GY	Back-to-back Link, gray	6.83
EUL-GTD	27W gradual inline touch dimmer	35.30
EUL-UCLP	U-Clip pack (2 clips)	9.87





**LED ACCESSORIES**

**LED POWER SUPPLIES - TRANSFORMERS**

18W, 60W

12V DC, equipped with mounting block that allows for 6 easy snap-in connections. Black in color.

**60W Power Supply**

Supplied with 6' 110/240V cord and plug.



**DC-SLELT60-CON**

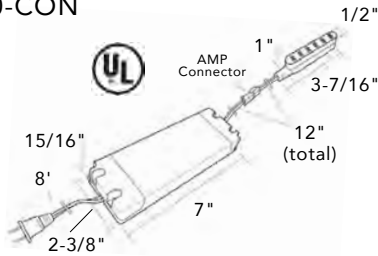

Code	Description	List
DC-SLELT60-CON	60W 12VDC Transformer	\$ 121.93

**LED WALL MOUNT POWER SUPPLIES**



12V DC Equiline Wall Mount Power Supplies. 6W includes 3 Snap Mounting Block, 15W includes a 6 Snap Mounting Block.



**DC-ELT6WP-CON**

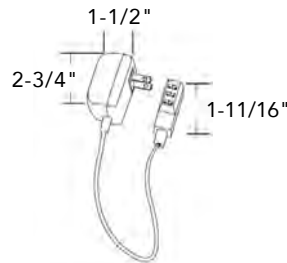

**DC-ELT15WP-CON**

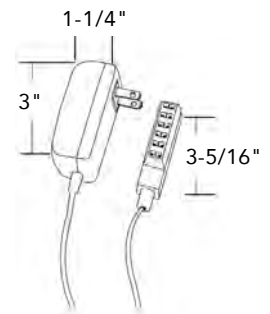

Code	Description	List
DC-ELT6WP-CON	6W 12VDC Wall Mount w/ 3 Snap Block	\$ 48.87
DC-ELT15WP-CON	15W 12VDC Wall Mount w/ 6 Snap Mounting Block	47.64

**MOUNTING BLOCK**

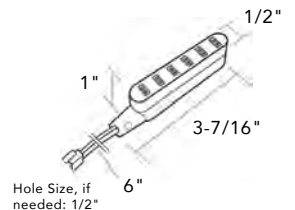

6 Snap Mounting Block. For Tresco DC Power Supplies only, 60W max. Add an extra mounting block to utilize the full capacity of the power supply. Can be hardwired on DC-E60D-CON dimmable Hardwire Power Supply.

Code	Description	List/ea
TRANS-MNT-BL	6-Snap Mounting Block	\$ 13.71

10



### LED ACCESSORIES



#### HARDWARE 12V DC POWER SUPPLY

Dimmable with std CL Wall Dimmers



DC-E60D-CON

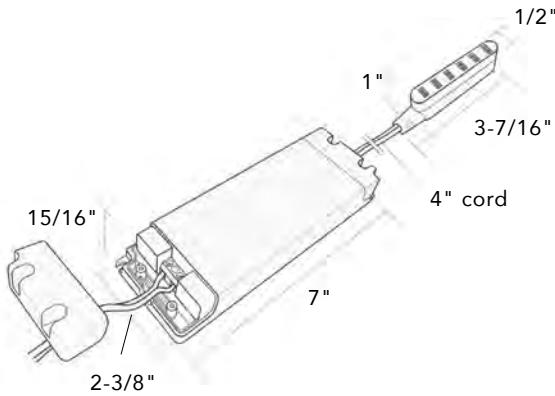

- 60W 12V DC dimmable electronic transformer
- UL listed
- Class 2 w/ short circuit and automatic reset
- Continuous smooth dimming by standard LED/CF Wall dimmers
- Works with all Tresco 12V DC dimmable LED fixtures
- Under 1" profile
- Wire directly into unit
- One 6-snap mounting block included

Code	Description	List/ea
DC-E60D-CON	Dimmable Hardware 60W Power Supply	\$ 211.51

#### LUTRON DIVA C-L DIMMER

Works with above LED Power Supply

- Matches existing switches
- Large paddle switch and a small slider
- Slide control to adjust lights, paddle switch returns light to your favorite level
- Power failure memory
- Standard RFI suppression
- Rated at 120 VAC, 60 Hz
- Use only with dimmable bulbs



Wall Dimmer  
(plate not included)

DVCL-153PH-WH	List \$ 74.82
---------------	---------------



#### ROUND SWITCH - 12V



Round Rocker Switch available in Black or White. 3/4" hole required for switch. 79" cord from switch to plug.

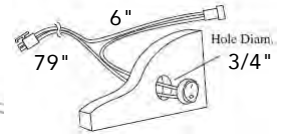
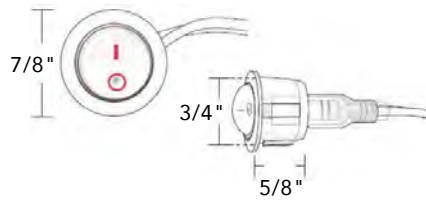

Code	Description	List/ea
RDSW-2M-WH	Round Switch, White	\$ 24.76
RDSW-2M-BL	Round Switch, Black	25.84

#### MANUAL ROTARY DIMMER

Provides On/Off power and dims lights from 1-100%. Available in Black or White.

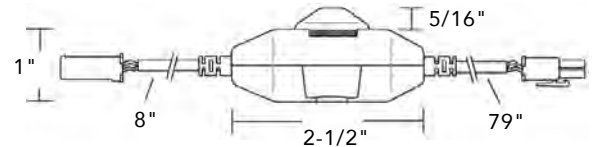
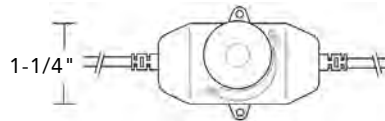

Code	Description	List
LED-DIMCON-WH	Manual Rotary Dimmer, White	\$ 58.07
LED-DIMCON-BL	Manual Rotary Dimmer, Black	57.98



## LED ACCESSORIES

### REMOTE CONTROL LED DIMMERS - 12V

Remote Control LED Dimmers feature radio-frequency, remote-control dimming to adjust lights from anywhere in the room - up to 30 feet. Provides On/Off power and dims lights from 100% to 1%.



The Dedicated Remote Control independently controls one specific dimmer in a room with other dimmers. The Universal Remote Control controls multiple dimmers in a room. 12V DC, 96W.

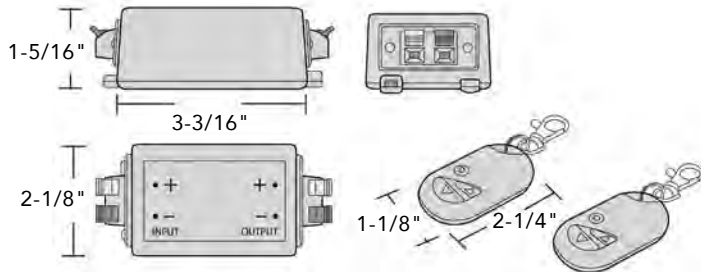

Code	Description	List/ea
LED-DIMRMT-12V8A	LED Dedicated Remote Control Dimmer	\$ 102.83
LED-DIMRMT-12V8A-U	LED Universal Remote Control Dimmer	89.97

### AMP CONNECTOR

Male AMP Connector for LED Light Fixture wiring.



10 each per pack, sold per pack.

Code	Description	List/pk
MALEAMP	AMP Connector	\$ 13.18

### EXTENSION CORD



Code	Description	List
LED-LINKD-25	Extension Cord, 10"	\$ 7.79
LED-LINKD-60	Extension Cord, 24"	8.71
LED-LINKD-120	Extension Cord, 48"	10.60
LED-LINKD-180	Extension Cord, 72"	13.16

10

### STARTER CORDS FOR FLEXIBLE LIGHTING

79" Starter Lead for Flexible Lighting. Connects each segment to mounting block of transformer. 5/8" hole required. Straight feed and split feed.

#### Straight Feed



#### Split Feed



Code	Description	List
LED-TPEPKT-2M	Straight Feed	\$ 12.10
LED-TPEPKT-2M-TEE	Split Feed	21.69

## LED ACCESSORIES



### JUMPER CORD

Link Flextape splices together. Positive and negative contacts on Flextape and FlexConnects should match up, to maintain proper polarity.



Code	Description	List
LED-TPELNK-5	Flextape Link Cord, 2"	\$ 6.67
LED-TPELNK-15	Flextape Link Cord, 6"	7.19
LED-TPELNK-25	Flextape Link Cord, 10"	7.93
LED-TPELNK-60	Flextape Link Cord, 24"	9.15
LED-TPELNK-120	Flextape Link Cord, 48"	9.49
LED-TPELNK-180	Flextape Link Cord, 72"	10.42

### ROUND DIMMER/SENSORS

10 Recessed or surface mounted lighting controllers for 12VDC. Can be placed between mounting block and power supply (sold separately) to control all the lights on one system, or between light and mounting block for isolated control of each light. Uses power supplies; DC-ELT12, 18, or 60. Max Wattage: 60W. 17/32" diameter, 2-3/8" Length. Cable input: 79", output: 6". Surface mount plate packaged with each controller. Nickel finish.



**LED-OVLTD-NI**  
 Touch ON/OFF and 0-100% dimming control. Hold finger down for dimming.



**L-RSMOT-NI**  
 Turns on when human motion is detected. Sensor range 0 - 118", 120° viewing. Time on: 30 sec. if no motion.



**LED-OVLDS-NI**  
 Door Open: Light on; Door Closed: Light off. Sensor range: 0 - 3-1/8".

Code	Description	List
LED-OVLTD-NI	Dimmer Control	\$ 51.53
L-RSMOT-NI	Motion Sensor	55.01
LED-OVLDS-NI	Door Sensor	49.94

### TEE CONNECTOR

For connecting FlexTape splices at a T-junction.



Code	Description	List
LED-TPELNK-TEE	Tee Connector	\$ 7.17

### RIGHT ANGLE CONNECTOR

For connecting FlexTape splices at a 90 degree corner.



Code	Description	List
LED-TPELNK-CON90	Right Angle Connector	\$ 6.39

### BACK TO BACK CONNECTOR

For Tape Lighting



10mm

Code	Description	List
L-XSBTB-1	Back to Back Connector for tape lighting, 24VDC	\$ 4.69



**FREEDIM ACCESSORIES**

**FREEDIM SERIES DECO WALL DIMMER**

- Single and 2-zone wireless dimmers
- 65' range from dimmer to receiver
- Controls all Tresco dimmable low voltage lights
- Control same set of lights from multiple Deco Wall Dimmers
- Can be programmed to multiple receivers for more lighting control

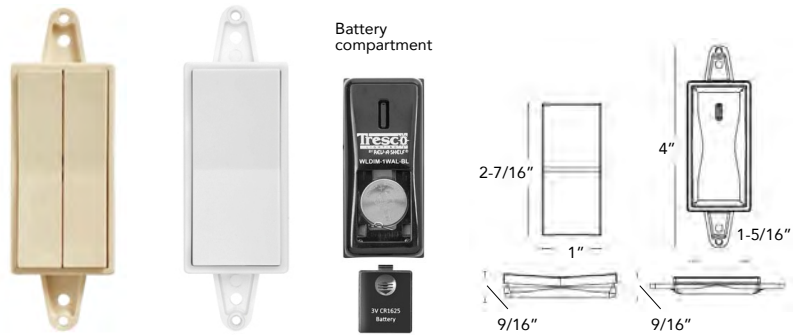

Light Almond finish, 2 Zone

White finish, Single Zone



Code	Description	Finish	List/ea
WLD-1WAL-WH	Wall Dimmer, Single Zone	White	\$ 167.99
WLD-2WAL-LA	Wall Dimmer, 2 Zone	Lt. Almond	184.03

**FREEDIM SERIES MICRO DIMMER**



- Single zone wireless dimmer
- Easy to replace, long life lithium battery
- 65' range from dimmer to receiver
- Controls all Tresco dimmable low voltage lights
- Built-in magnet; mounts to metal surfaces
- Screw mounts to wood surfaces
- Available in Nickel and Black finishes

Code	Description	List/ea
WLD-1RND-NI	Micro Dimmer, Nickel 5/8" Ht, 1-1/2" diameter	\$ 50.45
WLD-1RND-BL	Micro Dimmer, Black 5/8" Ht, 1-1/2" diameter	50.45

**FREEDIM SERIES SERIES 3 ZONE REMOTES**

- Independent control of 3 lighting zones (respectively) from a single remote
- Set brightness levels of all the zones to a desired level then save as a 'scene'
- 65 ft. range of control from remote to receiver
- Controls all Tresco dimmable low voltage lights



Must have at least one receiver (WLD-1REC next page) to operate. Remote is 5-15/16" (50mm) x 1-9/16" (39mm).

Code	Description	List/ea
WLD-3RMT-BL	3 Zone Remote, Black finish	\$ 76.13



## LED ACCESSORIES

### FREEDIM SERIES UNIVERSAL RECEIVER

12VDC  
 LED fixture

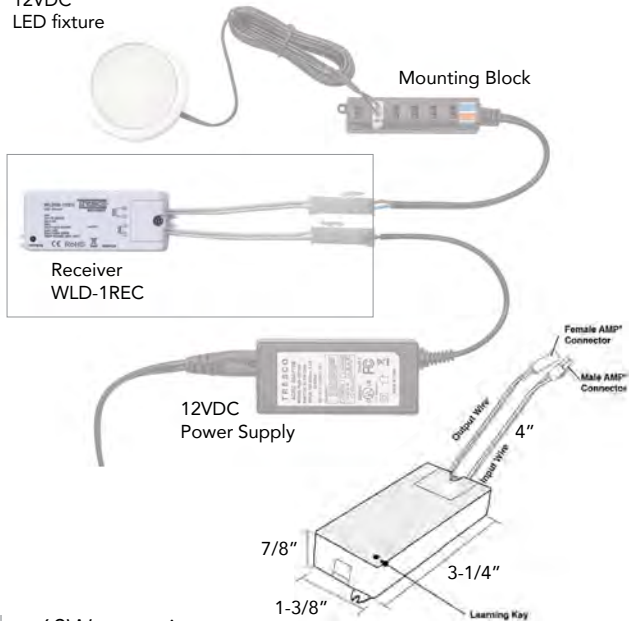

- 60W capacity
- Power failure memory
- Multiple receivers can be used on a single power supply or within a room to achieve multiple zones of control
- Compatible with all FreeDim Series controllers
- A single receiver can be programmed to up to 8 different FreeDim Series remotes/dimmers
- One WLD-1REC needed for each transformer

Code	Description	List/ea
WLD-1REC	Universal Receiver	\$ 103.85

### DUAL USB CHARGING STATION

USB charging station that ties into the same system as your 12V Tresco lighting system!

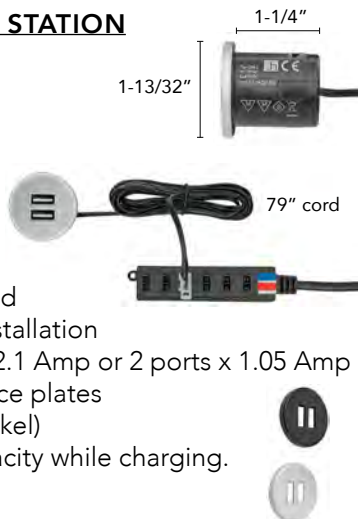

- 79" starter cord attached
- Low profile recessed installation
- Max load cap: 1 port x 2.1 Amp or 2 ports x 1.05 Amp
- Two interchangeable face plates included (Black and Nickel)
- Draws 10W at max capacity while charging. Has auto shut-off

Code	Description	List/ea
HUSB2-BLNI	Dual USB Charging Station	\$ 44.84

### INFINEX ALUMINUM EXTRUSIONS



Route a channel in wood 7/16" x 3/4" width and pressure fit extrusion in place.

Flush Aluminum Extrusion with no end caps - meant for channels that go the entire width or height of the case-work. Can be used with Flextape and Equiline Tape LED lighting.

- Comes with milk diffuser (unattached)
- Uses standard starter lead (LED-TPEPKT-2M)
- 72" (can be cut to size) x 3/4" width x 7/16" height

Code	Description	List/ea
XFL72-SC	Flush Aluminum Extrusion, 72" Satin Clear w/ Milk Diffuser	\$ 46.87

### 12V CLASS 2 WIRE

White, 50' rolls

Need to go through drywall or another permanently enclosed structure with your wires to connect Tresco lights? Use this Class 2 wire to stay within National Electric Code guidelines.

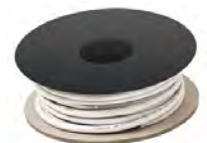

Code	Description	List/rl
16CL2-WH50	50' roll 16 AWG 12V Class 2 Wire	\$ 106.57



## LED ACCESSORIES

### **FINELINE TOUCH DIMMER**

For FineLine Stick LEDs

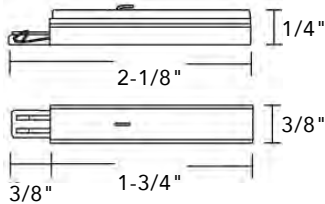

4-Step Dimmer Sensor (low, medium, high, off).  
 Max Load 27W. Controls up to 11 feet of FineLine  
 Lights. Attaches directly or remotely via link cord  
 to the Fineline Lights.

<u>Code</u>	<u>Description</u>	<u>List</u>
LED-STKDIM-TD4	Inline Touch Dimmer	\$ 46.55

### **FINELINE LINK CORDS**

For FineLine Stick LEDs

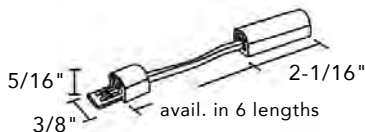

12VDC Stick Linking Cord for use with Tresco Fineline  
 lights. Fineline lights can be mounted end-to-end or  
 with these optional link cords. Available in six lengths.  
 Hole size (if needed): 7/16 in.

<u>Code</u>	<u>Description</u>	<u>List</u>
LED-STKLNK-5	2" Fineline Linking Cord	\$ 5.61
LED-STKLNK-15	6" Fineline Linking Cord	6.24
LED-STKLNK-60	24" Fineline Linking Cord	7.95
LED-STKLNK-120	48" Fineline Linking Cord	10.77
LED-STKLNK-180	72" Fineline Linking Cord	12.15

### **NEOLOOP ACCESSORIES FOR N1 & N2**

For Neoloop Side & Top Emitting Flexible LED Lights

#### **DIY Link Cords**

L-N1-LNK, L-N2-LNK

Splice together pieces  
 of Neoloop tape.



#### **Back-To-Back Connectors**

L-N1-BTB, L-N2-BTB



#### **End Caps**

L-N1-ENDCAP,  
 L-N2-ENDCAP



#### **U-Clip for Surface Mounting**

L-N1-UCLP, L-N2-UCLP

10 clips per bag.  
 Sold per bag.



#### **Starter Cords**

L-N1-12PKT-2M,  
 L-N2-12PKT-2M



#### **Side Emitting N1**

<u>Description</u>	<u>List</u>
L-N1-LNK25	N1 Link Cord, 10" \$ 39.13
L-N1-LNK60	N1 Link Cord, 24" 40.04
L-N1-LNK120	N1 Link Cord, 48" 45.54
L-N1-LNK180	N1 Link Cord, 72" 48.44
L-N1-BTB	Back to Back connector 15.01
L-N1-ENDCAP	End Caps .74
L-N1-UCLP	U-Clip for surface mount 15.36

#### **Top Emitting N2**

L-N2-LNK25	N2 Link Cord, 10" \$ 37.04
L-N2-LNK60	N2 Link Cord, 24" 37.90
L-N2-LNK120	N2 Link Cord, 48" 40.20
L-N2-LNK180	N2 Link Cord, 72" 42.79
L-N2-BTB	Back to Back connector 14.56
L-N2-ENDCAP	End Caps 1.44
L-N2-UCLP	U-Clip for surface mount 18.80



## TAPE LIGHTING

### **BLAZE 12V TAPE LIGHTING - 2.93 watts per foot**

Featuring over 250 lumens per foot, BLAZE 12V LED Tape Lighting excels as either task or ambient lighting. See next page for Aluminum Channels/Covers and other options.



BLBSC2



- 16.4' Spools, Max length per run 20'
- 2700K or 4200K Color temp
- 90+ CRI: Excellent color rendering
- UL Listed field cuttable every inch
- Fully dimmable with Switchex Driver/Dimmer
- 3M™ adhesive backing

Code	Description	List/roll
BLBSC2-27	16.4' Tape Lights, 2700K (warm)	\$ 280
BLBSC2-42	16.4' Tape Lights, 4200K (cool)	280

### **SWITCHEX DRIVER AND DIMMER SWITCH**

Combines an LED dimmer switch and LED power supply into a single integrated unit.

Three interchangeable face plate colors are included: glossy white, glossy light almond and glossy brown (trim plate not included).



DI-12V-SE-60W

Code	Description	List/ea
DI-12V-SE-60W	Switchex 60W Driver & Dimmer Switch, 12V DC	\$ 329.38

## ELEMENTAL LED

### **TRADITIONAL POWER SUPPLY FOR BLAZE LEDS**

#### **Plug-In Adapters 12W / 24W / 60W**

12V Portable, Plug-In Power Supplies. White Finish.



12W  
DI-0927

24W  
DI-0911

60W  
DI-0913

Code	Description	List/ea
DI-0927	12W Adapter. 2.35" x 1.75" x 1.4"	\$ 42.46
DI-0911	24W Adapter. 3.8" x 1.75" x 1.4"	59.14
DI-0913	60W Adapter. 4.7" x 2" x 1.25"	97.06

#### **DC Plug Extension Cable**

Extend the distance between any two LED products that have standard 1/4" DC plug. 39". White.



Code	List/ea
DI-0708	\$ 10.65

See next page for more options.





## ELEMENTAL LED

## ACCESSORIES

### ALUMINUM CHANNELS FOR BLAZE LEDS

#### Chromapath® Aluminum Channels, 48" Slim Design

Aluminum Channels protect and provide light diffusion for LED tape lights. They provide a rigid, dustproof housing that can be mounted on virtually any flat surface. Can be custom cut, as well as mounted end to end to any total length. 48" Lengths.



Code	Description	List/ea
DI-CPCHA-SL48	Alum. Channel, 48" Slim	\$ 31.90

#### Chromapath® Aluminum Channel Covers, 48"

Use with Aluminum Channels to protect and provide multiple levels of light diffusion for indoor LED tape lights. Choose clear or frosted:

**Clear Cover:** protects with no visible color shift or change in delivered lumens.

**Frosted Cover:** protects and slightly softens light. Note there is an average warm shift in Kelvin of 35K and an average 28% decrease in delivered lumens.

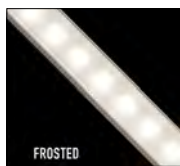

Code	Description	List/ea
DI-CPCHC-CL48	Cover, 48", Clear	\$ 10.62
DI-CPCHC-FR48	Cover, 48", Frosted	12.49

#### Chromapath® Aluminum Channel End Caps

Essential for providing a seal on CHROMAPATH Channels. A set of end caps includes one closed cap and one notched open cap that can accommodate wire up to 18 AWG. 5 sets per pack, Sold per pack.



Code	Description	List/Pk
DI-CPEC-SL	Slim End Caps, 5 sets	\$ 27.30

### OPTIONAL ACCESSORIES

#### Mini Terminal Junction Box

An easy way to splice wiring in a lighting application. Rated for high and low voltage electrical connections up to 450V. Features a removable terminal block for easily connecting a pair of wires.



DI-0841

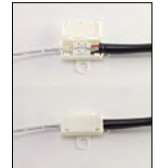

Code	Description	List/ea
DI-0841	Junction Box	\$ 6.07

#### Splice Connector

Connects indoor LED tape light to 12V power supply. 24", 8mm single color.



Code	List/ea
DI-0856	\$ 9.71

10

#### Flexible Extension

Connects two LED tape light sections and lets them make any 10-180° turn inside picture frames, display cases, and more. 8mm single color.



Code	Length	List/ea
DI-0860	3"	\$ 7.28
DI-0896	6"	10.61
DI-0897	12"	10.92



## GROMMETS

### LARGE PLASTIC CABLE GROMMET

Sugatsune

6-9/16" L x 3" W (overall)

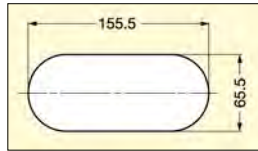

Hole Size

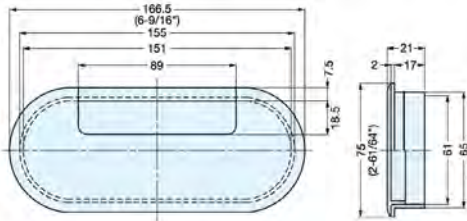

Code	Color	Ctn	List/ea
S165-76B	Black	10 ea.	\$ 8.09

### TRASH GROMMET



6" Hole, 6.8" Overall.

6" round finishing grommet to provide clean finished look. Often used to line trash receptacles. Black in color.

Code	Color	Ctn	List/ea
1044BK	Black	10 ea.	\$ 6.66

### TRASH CAN RING

Stainless Steel

6" Diameter,  
1" and 2" Depths.



Code	Depth	Finish	List/ea
TR6X1.SS	1"	Stainless Steel	\$ 43.62
TR6X2.SS	2"	Stainless Steel	74.14

### PLASTIC GROMMETS



**#1041**  
1" Hole  
Grommet

1" Bore,  
1-1/8" Overall.  
Accepts cords  
up to 13/16" wide.



**#1039**  
1-3/4" Hole  
Grommet

1-3/4" Bore,  
2" Overall.  
Accommodates  
most office machine  
plugs up to 1-5/8".



**#1031**  
2-1/2" Hole  
Grommet

2-1/2" Bore,  
3" Overall.  
Fits plugs up to  
2-1/4", suited for  
most computer uses.

#### 1" Bore, 1-1/8" Overall

Code	Color	Ctn	List/ea
1041BK	Black	10 ea.	\$ 2.99
1041BR	Brown	10	2.90
1041WH	White	10	3.70
1041GY	Gray	10	2.90

#### 1-3/4" Bore, 2" Overall

1039BK	Black	10 ea.	\$ 2.93
1039BR	Brown	10	2.93
1039WH	White	10	2.93
1039GY	Gray	10	2.93

#### 2-1/2" Bore, 3" Overall

1031BK	Black	10 ea.	\$ 3.85
1031BR	Brown	10	2.96
1031WH	White	10	2.96
1031GY	Gray	10	2.96
1031AL	Almond	10	2.92

### ELECTRIC TRIM RING

Single box, White



Designed to clean up electrical cutouts in the back of cabinets. For a single gang box and can be trimmed to specific return depths. Paintable for your custom application. White in color.

Code	Description	List/ea
ETR-SINGLE-WH	Trim Ring for single electric cutout	\$ 9.19

## WIRE ORGANIZATION

### WIRE ORGANIZER CHANNELS



Go from this...



to this.



Plastic wire channel is used to store and organize wire and cable on such items as entertainment centers, computer work stations, etc. Black in color with self-adhesive tape. Length: 2.5 meters (98.43").

Code	Ctn	List/ea
CPIWM1500T	36	\$ 39.57

### WIRE ORGANIZER CLIPS

Same as above except in 1" strips. Black in color. Projection: 1.09" Each piece has self-adhesive tape.

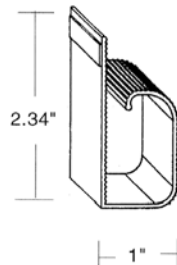

Code	Ctn	List/ea
CPIWM1500C	1000	\$ .42

## VENTS



C816



84126

Economy vents with high performance, rustproof aluminum, ventilates 44 to 129 square feet. Embossed margin adds rigidity. Revolutionary louver design boosts free area 11% - 17% yet is priced 20% - 40% lower than ordinary undereaves ventilators. 8x8 perma-coated aluminum screen attached for added protection.

Code	Overall Dimensions	Ctn	List/ea
84126	16" x 4"	24	\$ 8.67
C816	16" x 8"	72	8.85

## VENTS AND LOUVERS

### CABINET VENTILATING LOUVERS

Washington Products

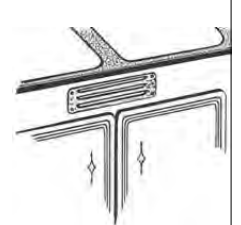

For apron above sink door. Outside dimensions: 10-7/16" x 2-7/8". Cut-Out dimensions: 9" x 2-1/2". 12 per box.

Code	Finish	List/ea
12-26	Bright Chrome	\$ 19.47

### MINIATURE VENTS

Under eave mounted attic intake vent. Louvers are stamped and formed, and the screen is securely held in place. Must be used in conjunction with adequate exhaust vents for proper operation. Mill finish. Screen: 10 mil, 8x8 mesh Aluminum Screen.



CV-1, CV-2, CV-3  
 6 ea. per pack,  
 Full packs only.



CV-4  
 Bulk - order  
 per each.

Code	Dia.	Rough Opening	Pack	List
CV-1	1-1/4"	1"	6	\$ 2.81
CV-2	2-1/4"	2"	6	4.35
CV-3	3-1/2"	3"	6	4.53
CV-4	4-1/2"	4"	1	7.53

10



## VENEER SHEETS

### FORMWOOD 2-PLY VENEER SHEETS



FormWood 2-Ply hardwood veneer has a perpendicular face-to-back construction utilizing a thin acrylic membrane to provide extra protection against bubbling, glue seepage and telegraphing. The product provides no unsightly edge lines, unlike phenolic-backed veneer. The crossband construction allows FormWood 2-Ply veneer to bend on moderate curves in the horizontal or vertical direction.

#### **4' x 8' Sheets. Wood Backing (1 per box)**

<u>Code</u>	<u>Description</u>	<u>List/sheet</u>
FJO461	Maple, 4' x 8'	\$ 134.24
FJO455	Cherry, 4' x 8'	136.08
FJO458	Red Oak, 4' x 8'	131.76
FJO505	Alder, 4' x 8'	187.65

### FORMWOOD PREMIUM VENEER SHEETS

High grade sanded veneers. Backing provides stability and flexibility while helping to minimize splitting, grainraise and glue seepage.



10 mil paper back. Sold in full boxes only.

#### **2' x 8' Sheets Unglued (2 each/box)**

<u>Code</u>	<u>Description</u>	<u>List/sheet</u>
FJG461	Maple, 2' x 8'	\$ 59.76
FJG454	Walnut, 2' x 8'	53.43
FJG455	Cherry, 2' x 8'	54.16
FJG457	White Oak, 2' x 8'	72.22
FJG458	Red Oak, 2' x 8'	49.31

#### **2' x 8' Sheets w/PSA (2 per box)**

With Pressure Sensitive Adhesive Backing; peel off back and press on. 10 mil paperback.

<u>Code</u>	<u>Description</u>	<u>List/sheet</u>
FJA461	Maple, 2' x 8'	\$ 97.65
FJA453	Red Birch, 2' x 8'	133.00
FJA455	Cherry, 2' x 8'	88.26
FJA458	Red Oak, 2' x 8'	78.63
FJA505	Alder, 2' x 8'	123.77

#### **4' x 8' Sheets Unglued (1 per box)**

10 mil paperback.

<u>Code</u>	<u>Description</u>	<u>List/sheet</u>
FJK461	Maple, 4' x 8'	\$ 97.95
FJK452	White Birch, 4' x 8'	105.99
FJK453	Red Birch, 4' x 8'	240.57
FJK454	Walnut, 4' x 8'	140.72
FJK455	Cherry, 4' x 8'	98.83
FJK456	Mahogany, 4' x 8'	92.67
FJK457	White Oak, 4' x 8'	129.53
FJK458	Red Oak, 4' x 8'	79.85
FJK505	Alder, 4' x 8'	156.59
FJK239	Rift White Oak, 4' x 8'	187.20

#### **Bulk 4' x 8' Sheets Unglued - 10 sheets/box.**

Matched for grain and color by factory. 10 mil paperback. Sold in full boxes only.

FJK461X	4' x 8'	Maple	\$ 766.00
---------	---------	-------	-----------



## EDGEBANDING, WOOD

### PRE-GLUED EDGEBANDING

Genuine Wood Veneer

Genuine Wood veneer in **250' rolls**. Pre-glued. The resin impregnated backer helps reduce splitting, tearing and checking. Unfinished. .5mm.



Pack: 12 Rolls

Code	Width	Specie	List/Roll
KO-MP-58	5/8"	Maple	\$ 29.45
KO-WBI-58	"	White Birch	29.98
KO-RWO-1316	13/16"	Rift White Oak	80.57
KO-WBI-1316	"	White Birch	54.00
KO-RBI-1316	"	Red Birch	37.85
KO-WL-1316	"	Walnut	53.12
KO-CH-1316	"	Cherry	47.73
KO-MAA-1316	"	Mahogany	41.67
KO-WO-1316	"	White Oak	49.93
KO-MP-1316	"	Maple	43.32
KO-ASH-1316	"	Ash	48.53
KO-RA-1316	"	Alder	37.93
KO-WBI-78	7/8"	White Birch	47.59
KO-RBI-78	"	Red Birch	36.64
KO-WL-78	"	Walnut	74.46
KO-CH-78	"	Cherry	59.45
KO-WO-78	"	White Oak	60.92
KO-RO-78	"	Red Oak	40.02
KO-MP-78	"	Maple	51.52
KO-RA-78	"	Alder	47.78
KO-ASH-78	"	Ash	48.00
KO-VFI-78	"	Vert Grain Fir	72.00

### POLYBAGGED PRE-GLUED EDGEBANDING

Real Wood Veneer



**Pre-Glued** 13/16" Wide x 50' Long

Code	Specie	Ctn	List/bg
M8-WBI-1316	Wht Birch	12 cds.	\$ 19.75
M8-RO-1316	Red Oak	12	20.31
M8-MP-1316	Maple	5	17.81

**Peel & Stick** 13/16" Wide x 50' Long

Backed with pressure sensitive adhesive

Code	Specie	Ctn	List/cd
MO-NBI-1316	Nat Birch	10 bgs.	\$ 32.39
MO-CH-1316	Cherry	12	25.63
MO-RO-1316	Red Oak	10	35.63
MO-MP-1316	Maple	10	32.39

### FASTCAP "FASTEDGE" PEEL & STICK EDGEBANDING



Amazing Adhesion



No more Ironing!

Fastedge is the perfect solution for field repairs, inside and outside radiuses, scribe tape, and other applications. Durable and easy to use. Made from high quality PVC and real wood veneers. High performance pressure sensitive acrylic adhesive increases in strength as it cures, providing a long lasting, permanent bond. (For other veneers or PVC/laminate matches contact your sales representative.)

Rolls are 250' in length, all 15/16" Width. Real wood unless noted as PVC.

Code	Description	List/rl
FESP1516-250WH	PVC, White	\$ 138.94
FESP1516-250BL	PVC, Black	138.94
FEWP1516-250HM	PVC, Hard Rock Maple	163.09
FESW1516-250CH	Cherry	248.82
FESW1516-250MP	Maple	248.71
FESW1516-250AD	Alder	248.71

### Pre-Finished Peel & Stick

FEPW1516-250MP	Maple	\$ 274.85
----------------	-------	-----------

### SPEEDROLLER PRO FOR FASTEDGE



Ergonomically designed with laminate rollers to be used for any PSA application - especially FastEdge and SpeedTape. Includes two sets of interchangeable wheels (rubber and steel), 3-1/2" in length.



SPEEDROLLER-PRO List \$ 56.91/ea



## WOOD EDGEBOARDING

### AUTOMATIC EDGEBOARDING

Genuine Wood Veneer

Fleece-backed, Automatic  
Edgebanding. **500' Rolls.**  
Unfinished. .5mm.



Pack: 12 Rolls

Code	Width	Specie	List/Roll
K6-MP-58	5/8"	Maple	\$ 43.99
K6-RWO-78	7/8"	Rift White Oak	127.57
K6-WBI-78	"	White Birch	75.37
K6-RBI-78	"	Red Birch	86.04
K6-WL-78	"	Walnut	95.68
K6-CH-78	"	Cherry	77.10
K6-MAA-78	"	Mahogany	66.44
K6-WO-78	"	White Oak	92.41
K6-RO-78	"	Red Oak	58.97
K6-MP-78	"	Maple	91.66
K6-ASH-78	"	Ash	90.89
K6-VFI-78	"	Vertical Fir	133.62
K6-RA-78	"	Red Alder	94.55
K6-BAM-78	"	Carmel Bamboo	182.40
K6-SBE-78	"	Steamed Beech	112.95
K6-MP-1516	15/16"	Maple	86.37
K6-MP-118	1-1/8"	Maple	110.00

### FORMWOOD THICK WOOD VENEER

#### AUTOMATIC EDGEBOARDING - 328' ROLLS

Advanced Finger Joints

Real Wood:  
High Grade Veneer  
Sanded, No Backing



Automatic - 328' Rolls: 1mm Thick Wood Veneer

Code	Description	List/roll
NG1MMMAP58	1mm, 5/8", Maple	\$ 131.37
NG1MMMAP78	1mm, 7/8", Maple	159.28
NG1MMCHE78	1mm, 7/8", Cherry	172.56
NG1MM-RWO-78	1mm, 7/8", Rift Wh Oak	206.07
NG1MMWAL78	1mm, 7/8", Walnut	215.89
NG1MMMAP138	1mm, 1-3/8", Maple	199.37
NG1MMCHE138	1mm, 1-3/8", Cherry	234.32
NG1MMWAL138	1mm, 1-3/8", Walnut	282.67
NG1MM-MAP-158	1mm, 1-5/8", Maple	189.00

### CLEAR FINISHED EDGEBOARDING

Genuine Wood Veneer

Pack: 12 Rolls



### Pre-Glued, 250' Rolls

Code	Width	Specie	List/Roll
KP-MP-58	5/8"	Maple	\$ 56.68
KP-CH-78	7/8"	Cherry	69.00
KP-MP-78	"	Maple	70.88
KP-WL-78	"	Walnut	73.83
KP-CH-1316	13/16"	Cherry	64.00
KP-MP-1316	"	Maple	73.65
KP-WBI-1316	"	White Birch	76.24

### Automatic, 500' Rolls

KTB-MP-58	5/8"	Maple	\$ 124.90
KTB-MP-78	7/8"	Maple	165.18
KTB-WL-78	"	Walnut	171.87
KTB-CH-78	"	Cherry	110.70

### PSA, 50' Rolls. Peel off backer, Pack: 12 cards

Retail Packs: 1 roll/card

Code	Description	List/cd
MZ-MP-1316	13/16" Maple	\$ 36.91
MZ-RO-1316	13/16" Red Oak	29.66
MZ-WBI-1316	13/16" Wht Birch	44.14
MZ-CH-1316	13/16" Cherry	34.75

### SHELF EDGING

Snap-On



High impact strength, butyrate plastic edging to fit nominal size plywood & particle board shelves for a finished appearance. Spring gripper action holds edge secure without need for fasteners. White satin finish. Paintable but do not use lacquer.

Code	Description	Ctn	List/ea
588WH	5/8" x 8' White	125	\$ 4.13
348WH	3/4" x 8' White	84	6.60



## EDGEBANDING, PVC

### POLYESTER EDGEBANDING

Pre-Glued

Polyester pre-glued edgelanding in 250' rolls. 2-ply.



Code	Width	Color	Ctn	List/rl
D4-WH-58	"	White	5	\$ 35.68
D4-ALM-34	3/4"	Almond	5	40.01
D4-BL-34	"	Black	5	40.32
D4-WH-34	"	White	5	44.51
Y1-PNT-34	"	Paintable	5	34.70
D4-ALM-1316	13/16"	Almond	5	40.44
D4-BL-1316	"	Black	5	55.40
Y1-PNT-1316	"	Paintable	4	34.64
D4-ALM-78	7/8"	Almond	4	39.27
D4-BL-78	"	Black	5	47.77
D4-WH-78	"	White	4	56.00
PG-HRM78	"	Hard Rock Maple	10	65.21
D4-WH-2	2"	White	2	95.00

### PVC EDGEBANDING

Automatic

PVC edgelanding for automatic edgelanding machines.



#### PVC White / .5mm Thickness / 600' rolls

Code	Width	Roll Length	List/rl
WH-58	5/8"	600'	\$ 49.00
WH-78	7/8"	600'	49.00

#### PVC White / 1mm Thickness / 300' rolls

WH-1MM-1516	15/16"	300'	\$ 97.01
-------------	--------	------	----------



#### PVC Black / .5mm

1005-9-78	7/8"	600'	\$ 37.65
-----------	------	------	----------

#### PVC Black / 1mm Thickness / 300' rolls

BL-1MM-1516	15/16"	300'	\$ 110.00
-------------	--------	------	-----------



#### PVC Hardrock Maple / .5mm

HRM-58	5/8"	600'	\$ 91.42
HRM34	3/4"	600'	88.52
HRM78	7/8"	600'	91.18
M1701DB	15/16"	600'	98.84

#### 1mm Thickness - PVC HRM

HRM-1MM-1516	15/16"	300'	\$ 119.00
--------------	--------	------	-----------

#### 2mm Thickness - PVC HRM

4975P-1202-1	3/4"	328'	\$ 156.54
4975P-1502-1	15/16"	328'	178.49

Other PVC colors, both in .5mm and 3mm are available on a special order basis.

11

### POLYBAGGED POLYESTER - PRE-GLUED

13/16" Wide x 50' Long

Code	Color	Ctn	List/bg
M7-BL-1316	Black	12	\$ 17.14
M7-MWH-1316	Melam Wht	12	16.95

### POLYBAGGED POLYESTER - PEEL & STICK

13/16" Wide x 50' Long

Code	Color	Ctn	List/bg
M9-WH-1316	White	12 bgs	\$ 19.11
M9-BL-1316	Black	12	20.75

### PAINTABLE POLYESTER EDGEBANDING

500' Rolls, Automatic



Code	Width	Ctn	List/rl
PNT-1516	15/16"	5	\$ 116.94

## SPEED TAPE

### FASTCAP SPEEDTAPE

Contact Cement on a Roll



1" - Great for edgebanding



2" - Great for face frames

SpeedTape is an ultra bond transfer adhesive. Apply to a substrate then peel off paper backing and stick on laminate or veneer. Excellent for refacing, locating moldings, eliminating nail holes, and cabinet scribe. Apply edging without the glue clean-up from sprayed or rolled glue. Rolls are 50'. Other sizes can be special ordered.

Code	Size	List/rl
ST-34	3/4" x 50'	\$ 13.27
ST-1	1" x 50'	17.58
ST-2	2" x 50'	35.16

### HAND EDGEBANDING IRON



Thermostat adjusts surface temperature. Useful for applying preglued edgebanding and for in-the-field repairs. Used for warming plastics and resilient materials to prevent cracking or crazing when making bends. Handy for heating loose areas or lifted edges to reactivate the adhesive for rebonding. The bases are about 1-5/8" x 4". 250° to 350°F (176°C).

Cat. No. HI-165A, Length 12", Wt 1.5 lb, 120 VAC, 165 W

Code	Description	List/ea
HI-165A	Hand Iron	\$ 94.50

## EDGING ACCESSORIES

### VIRUTEX EDGE TRIMMER

This tool simultaneously trims both edges of vinyl or other press-on edging. For panels 9/16" to 1-3/4" thick.



Code	Description	Ctn	List/ea
ET93	Edge Trimmer	1 ea	\$ 42.27
ET94RP	Replacement Blades (6 ea. per card)	1 set	25.16

### VIRUTEX END TRIMMER

Manual end trimmer.

Allows a perfect, clean and high quality cut on all the corners of the board. No other finishing operations are needed.



Equipped with double-sided blades. Cuts edgebanding up to 1mm thick. (Not for laminates)

Code	Description	List/ea
RC21E	End Trimmer	\$ 80.56

### VIRUTEX LAMINATE CUTTER

Strip cutter for laminates, quick and easy to use. With it, you obtain a clean splinter free cut with no waste. Also used for the edgebanding process.



Special system of cutting made of two wheels that make a very clean cut, with no waste and with a guide to keep the strip straight. Planing width: 12-110 mm, Cutting depth: 0-2 mm, Weight: 2.65 lbs.

Code	Description	List/ea
C015L	Laminate & Veneer Cutter	\$ 315.00



**MAKSIWA®** Portable Edgebander and Edge Trimmer

**Portable Edgebander CBC.E Net \$ 2299**

This portable, automatic edgebanding machine is designed to be used with traditional glue pellets and is compatible with PVC, ABS and real wood edgebanding. It is capable of gluing tape from .3mm to 2mm in thickness and up to 3" in width. The machine comes equipped with a digital temperature thermostat for precise heat control. Convenient, portable, and economic for the discerning woodworker.

Tape thickness: .3 - 2mm  
 Max. Tape width: 3" (80mm)  
 Power: 1500 W  
 Motor/Voltage: 110V - 1 Phase  
 Weight: 114.6 lbs.  
 Box dimensions: 32.7" x 21.2" x 19.3"



**Edge Trimmer Machine RBB.1000 Net \$ 1169**

Precise trimming and scraping ensure a perfect finish for edgebanding applied to MDF or similar wood panels. Easy to operate, simple to install, and works with ABS, PVC and real wood. Versatile mounting system allows attachment to any kind of work bench.

Max Workpiece Height: 2-3/8" (60mm)  
 Table dimensions: 39" Length x 6 to 16"  
 Trimmer Speed: 32 RPM  
 Power: 500 W  
 Weight: 41.9 lbs.



**Workbench for Edge Trimmer MA.1000 (Optional) Net \$ 649**

MDF work table with 39" x 16-1/2" of useable surface area. Structure is made of rigid metal and supports up to 440 lbs.

Contains a drawer for storing accessories, 79" power cord, and 2 electrical sockets. Table legs are retractable and come with wheels for easy transport.



**Factory Recommended Jowat Pellets 282.20 for CBC.E Edgebander**

See page 1107 for details.

Low-viscosity hot melt with fast melting properties, long open time, and good color and heat stability.

Low Temp, low feed speed. Natural in color.



Code 282.20 List/bg \$ 366.96



## DORUS HOT MELT ADHESIVE



### **DORUS HOT MELT PELLETS**



#### **KS205 Hot Melt Pellets**

High Viscosity

High viscosity, excellent bonding, and high heat resistance make this an ideal all-purpose edgebanding adhesive. The spread and flow qualities allow both moderate and high speed applications without stringing. EVA rubber based.

Recommended for veneer, polyester, PVC, melamine, solid wood, ABS, thick PVC and laminate. 55 lb. bag. Sold per bag.

Application roller: 220° C (425° F)  
Melting container: 200° - 210° C, (392 - 410° F)  
Feed speed: Minimum 50 ft./minute

<u>Code</u>	<u>Color</u>	<u>List</u>
KS205N	Natural	\$ 864.37
KS205W	White	1025.15

#### **KS217 Hot Melt Pellets**

Low Viscosity

Low viscosity, EVA based hot melt. Recommended for use in granular feed or quick step hotmelt systems. Has fast melting properties, and easy spread and flow. It should run at moderate to high line speeds and is formulated not to string. Superior bonding strength.

Recommended for veneer, polyester, PVC, melamine, solid wood, ABS, tropical and oily veneers, laminates and thick PVC. 55 lb. bag. Sold per bag.

Application roller: 220° C (428° F)  
Melting container: 190° - 210° C, (374° - 410° F)  
Feed speed: Minimum 50 ft./minute

<u>Code</u>	<u>Color</u>	<u>List</u>
KS217N	Natural	\$ 884.63
KS217W	White	886.00

#### **KS208/2 Hot Melt Pellets**

Medium Viscosity

Recommended for veneer, polyester, PVC or melamine. A medium viscosity EVA hot melt with fast melting properties and good flowing characteristics that permit high feed speed without stringing. Sold per 55 lb. bag.

Application roller: 210° C (410° F)  
Melting container: 200° - 210° C, (392° - 410° F)  
Feed speed: Minimum 40 ft./minute

<u>Code</u>	<u>Color</u>	<u>List</u>
KS2082N	Natural	\$ 612.31



### **DORUS HOT MELT CARTRIDGES**



**HKP21**  
Medium Speed

**HKP25**  
Slow Speed

The viscosity, spread and flow characteristics of these cartridges were specially formulated for use in Holzher machines. Dorus adhesives will not clog or block the application nozzles on the special glue application head.

Processing Temperature: 200-220°C (392-428° F)  
Feed speed (Holzer machine): minimum 30 ft/minute  
Heating time: 2-4 minutes

**Medium speed**, recommended for veneer, polyester, PVC, melamine, solid wood, thick PVC, and ABS. 45 cartridges per box. Sold per box.

<u>Code</u>	<u>Color</u>	<u>List</u>
HKP21	Natural	\$ 533.93

**Slow speed**, recommended for veneer, polyester, PVC, melamine, solid wood, thick PVC, high pressure laminates and ABS. 45 cartridges per box. Sold per box.

<u>Code</u>	<u>Color</u>	<u>List</u>
HKP25	Natural	\$ 795.91



## HOT MELT GLUE

### JOWAT HOT MELT GLUE

Medium low viscosity hotmelt. Good adhesion to high pressure laminate. Good color and heat stability in the melt. Ethylene-Vinyl-acetate base.



Hotmelt for Holzher type cartridge edgebanders. Especially suitable for high pressure laminates; also used for solid wood, veneer, PVC, and resinated paper edgebands.

Application Temp: 180-200°C/356-392F in the melt.  
Feed Speed: approximately 10-40 m/min.  
(30-120 ft./minute)

### Hot Melt Pellets: 44 lbs/bag

Code	Color	List/bag
288.60	Natural	\$ 262.86
288.61	White	291.46
288.62	Brown	309.34
288.63	Black	262.83
280-90*	Clear	332.62
280-30*	Translucent (user friendly)	353.85

\* Higher heat resistance than the 288. Works on all colors. Use less of this as it is pure glue, no fillers.

### Hot Melt Pellets: 44 lbs/bag

Suitable for primed PVC, ABS, PP, veneer, solid wood and resinated paper edgebands. Can also be used for softforming. **Excellent thermal stability, no stringing.** Medium viscosity.

### For Contour Edgebanding

Code	Color	List/bag
282.20	Natural	\$ 366.96

## JOWAT

### JOWAT HIGH HEAT RESISTANT HOT MELT GLUE

Equal to Doris  
KS215, KS205

Characteristics: High viscosity hotmelt. High heat (167°F) resistance and good cold flexibility of glue line. Excellent color and heat stability in the melt. Excellent on high speed glue lines.



Applications: Hotmelt for automatic edgebanding suitable for PVC, solid wood, veneer, and resinated paper edgebands. Also, used for soft-forming applications. (Not recommended for HPL applications).

Direction for Use: Application Temperature: 200° to 220°C/392° to 428°F in the melt.

Feed Speed: Roller applications: 50-60 ft/min.  
Nozzle application: 30-120 ft/min.

### Hot Melt Pellets: 44 lbs/bag

Code	Color	List/bag
288-50	Natural	\$ 336.30

### Hot Melt Cartridges: 35 lbs./box (48 cart.)

Code	Color	List/box
286.80	Natural	\$ 358.73
286.81	White	303.73
286.82	Brown	301.41
286.83	Black	303.73
286.30	Translucent	431.29



11

**Abet Laminati Order Form**

Email form to orders@macmurraypacific.com

Date \_\_\_\_\_

Contact Name \_\_\_\_\_

Contact Phone # \_\_\_\_\_

Account Name \_\_\_\_\_

Street \_\_\_\_\_

City \_\_\_\_\_

State \_\_\_\_\_ Zip \_\_\_\_\_

Job Name \_\_\_\_\_

**ABET LAMINATI :**

- Offers the largest choice of colors and designs in North America
- Cutting edge styles and colors; design driven laminates
- Europe's leading producer of High Pressure Laminates
- See [www.abetlaminati.com](http://www.abetlaminati.com) for pictures

	Qty	Stock (#)	Finish
1			
2			
3			
4			
5			
6			

Colors and patterns:

A full range of 408 solid colors, wood grains, patterns, stones, metals, marbles, translucents, magnetics and iridescent colors is available. Custom Silkscreen and digital print patterns are available on special order.

Finishes:

- |              |  |
|--------------|--|
| Sei          | A smooth textured matte with a moderate sheen            |
| Soft         | A smooth low sheen                                       |
| Super Matte  | The look of flat paint                                   |
| Lucida       | High gloss finish  |
| Millerighe   | Horizontal line embossed finish                          |
| Millerighe-2 | Horizontal line embossed finish                          |
| Cresp        | An embossed finish with highlighted pattern              |
| Cresp-2      | Raised vertical line embossed finish                     |
| Fiber        | Fiber inclusion embossed finish                          |
| Mandarin     | A pebbled textured finish with moderate reflective value |
| Nutshell     | Woodgrain tick embossed pattern                          |
| Magma        | Embossed stone pattern                                   |
| Muro         | Embossed pattern   |
| Multirighe   | Embossed line pattern                                    |
| Satinata     | Brushed metal pattern                                    |
| Onda         | An embossed grooved curved pattern                       |

Std Sheet Size: 51" (130cm) x 120" (305 cm)  
 Std Thickness: .035" (0.9 mm) (post formable)  
 Stocked in California.

**Please send me:**

Sample Chain     Chip Book     Chip Boards

only a sampling of ABET colors

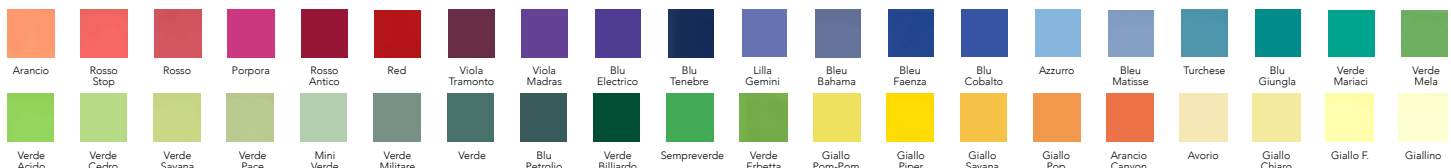



## ROLLING LADDERS

### **PUTNAM NO.1 ROLLING LADDER**

The Putnam No.1 Rolling Ladder is made of best grade red oak (standard, but other hardwoods available), which is filled and finished. Steps are screwed to rails, not nailed, and rods are placed under each step, for greater strength.

The top slide feature, available in either roll type (No. 210) or hook slide, (No. 230) permits the rolling ladder to be pulled out for use or pushed back against shelves to conserve space. The roll type fixture (No. 210) is for a ladder permanently attached to the track. The hook slide feature (No. 230) is used when a ladder needs to be removed from one section of track to another.

The ladder easily rolls on bottom fixtures (No. 270). Also available is an old style bottom fixture (No. 270 Old Style) for a more antique look.

In lieu of a regular oak finish, (a Dupont clear penetrating wood finish) the ladder can be finished in various popular wood shades, as desired. You may choose from any of the Minwax interior wood finishes. Should you desire to finish the ladder yourself, unfinished oak is also available.

The normal measurements of The No. 1 Rolling Ladder are as follows:

Height: As required	Side Rails: 3-1/4" deep
Steps: 4-1/4" deep	Outside Width: 16"

Rolling Library Ladder

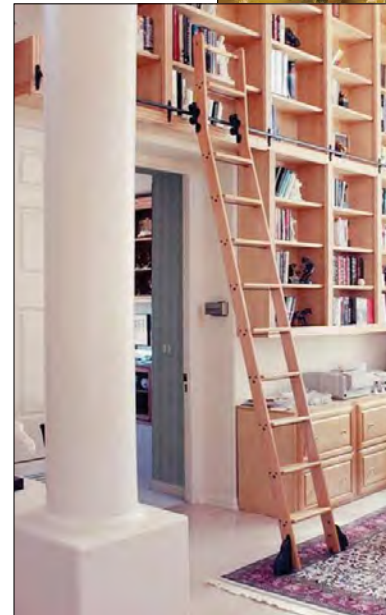

Library Ladder with a Top Bent

### **"TOP BENT" ROLLING LADDER FOR A LOFT**

Walk through the top of this ladder into a loft or mezzanine. The "Top Bent" section is normally 24" high. For ordering, please provide vertical measurements from floor to track.

Top Bent Rolling Ladder for a Loft



### **ALL LADDERS ARE MADE TO ORDER. PLEASE INDICATE:**

1. Height (floor to center of track. 7" clearance above the track is required)
2. If Top Bent is desired, specify "Library Ladder with a Top Bent", or "Top Bent Ladder for a Loft". Top Bent section is standard 24" high.
3. Length of track and any 90° or 135° curves
4. Bracket desired (vertical, horizontal, or top of shelf mount)
5. Stamped or Old Style bottom fixtures
6. Type of wood-  
Red Oak is standard. Mahogany, Maple, Birch, Cherry, Walnut, and others are available at an extra charge
7. Wood Finish -  
DuPont clear, any Minwax interior wood finish, or unfinished. (If nothing is specified, factory will ship "clear finished")
8. Finish on top and bottom fixtures on ladder, track and brackets -  
Standard-ladder fixture is zinc plated, steel track is aluminum painted  
Also available in: Ant. Brass, Satin Brass, Satin Nickel, Pol. Chrome, Oil R. Bronze, Pol. Nickel, Pol. Brass & Black.

If shelving or layout is unusual, please provide a rough sketch.

You can find Putnam Rolling Ladder Order Form on our website: [macpac1.com/forms.html](http://macpac1.com/forms.html)



### ROLLING LADDERS Cont.

#### ROLLING LADDER - TOP FIXTURES

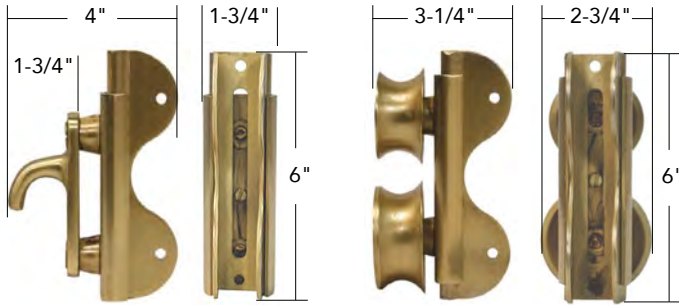

No. 230 Hook Slide

No. 210 Roll Type

#### ROLLING LADDER - BOTTOM FIXTURES

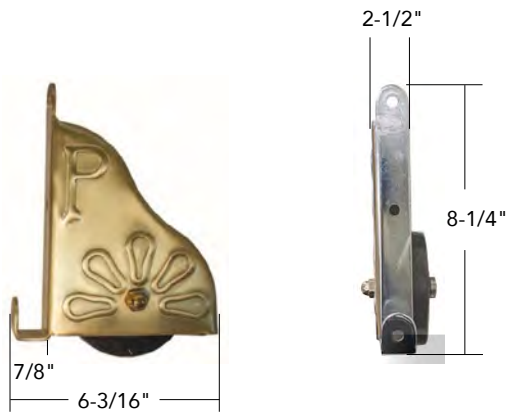

No. 270 Stamped

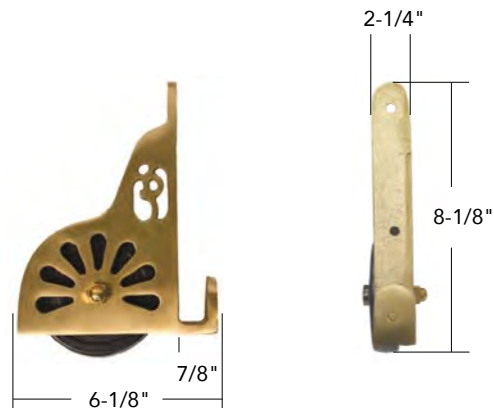

No. 270 Old Style

#### BRACKETS FOR NO.1 TRACK

	Roll Type <u>No. 210</u>	Hook Slide <u>No. 230</u>
Vertical Mount on Uprights	No. 14	No.14H
Horizontal Mount	No. 27	No. 27H
Top of Shelving Mount	No. 29	No. 29H

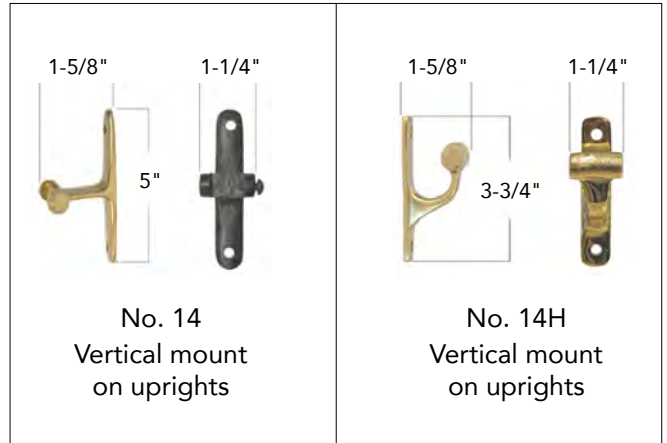

No. 14  
Vertical mount  
on uprights

No. 14H  
Vertical mount  
on uprights

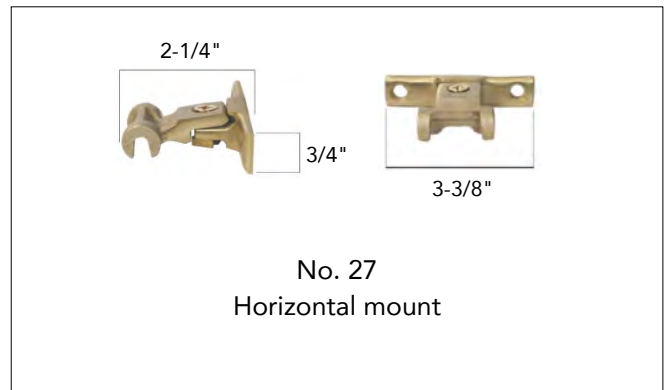

No. 27  
Horizontal mount



No. 27H  
Horizontal mount



# POSTS & COLUMNS

**PRIDE**



**PRIDE INDUSTRIAL**

**DECORATIVE WOODEN POSTS & COLUMNS**

Finely carved architectural wood. All Special Order, Fast Delivery.

### Square Post



**POST-S-**

35-1/4" H  
3-1/2" D  
3-1/2" W

### Square Fluted Post



**POST-K-**

35-1/4" H  
3-1/2" D  
3-1/2" W

### Turned Post



**POST-A-**

35-1/4" H  
3-1/2" D  
3-1/2" W

### Rope Post



**POST-C-**

35-1/4" H  
3-1/2" D  
3-1/2" W

Code	AL	MP	RW
POST-S-	\$ 161.06	\$ 171.98	\$ 135.84
POST-K-	170.87	181.75	145.66

Code	AL	MP	RW
POST-A-	\$ 154.90	\$ 176.10	\$ 89.73
POST-C-	168.99	190.18	110.07

### Shaker Post



**POST-X-**

35-1/4" H  
3-1/2" D  
3-1/2" W

### Mission Post



**POST-M-**

35-1/4" H  
3-1/2" D  
3-1/2" W

### Reed Post



**POST-B-**

35-1/4" H  
3-1/2" D  
3-1/2" W

### Tuscan Post



**POST-G-**

35-1/4" H  
3-1/2" D  
3-1/2" W

Code	AL	MP	RW
POST-X-	\$ 196.03	\$ 213.12	\$ 155.43
POST-M-	240.47	279.54	175.11

Code	AL	MP	RW
POST-B-	\$ 161.95	\$ 183.14	\$ 95.30
POST-G-	161.95	183.14	95.30

Wood Species: AL - Alder, MP - Maple, RW - Rubberwood



**PRIDE**

**CORBELS**



**PRIDE INDUSTRIAL**

**DECORATIVE WOODEN CORBELS**

Finely carved architectural wood. All Special Order, Fast Delivery.

**CRAFTSMAN CORBEL**



**CORBEL-K-**  
10" L  
3-1/2" W  
7" Proj



**CORBEL-KL-**  
13-3/4" L  
5" W  
8" Proj

<u>Code</u>	<u>AL</u>	<u>MP</u>	<u>RW</u>
CORBEL-K-	\$ 140.24	\$149.37	\$ 102.13
CORBEL-KL-	262.97	280.91	188.71

**SHAKER CORBEL**



**CORBEL-M-13-**  
9" L  
3.15" W x  
4.1" Proje



**CORBEL-M-14-**  
14" L  
6.375" W  
4.9" Proj

<u>Code</u>	<u>AL</u>	<u>MP</u>	<u>RW</u>
CORBEL-M-13-	\$ 96.02	\$ 102.61	\$ 83.76
CORBEL-M-14-	247.84	264.77	189.72

**TRADITIONAL CORBEL**



**CORBEL-T-1-**  
Small Traditional Corbel  
10" L x 4-1/2" W x 5-1/4" Proj.



**CORBEL-T-4-**  
Traditional Bar Bracket  
13" L x 3-3/8" W x 7-3/4" Proj.

<u>Code</u>	<u>AL</u>	<u>MP</u>	<u>RW</u>
CORBEL-T-1-	\$ 176.10	\$ 183.14	\$ 154.90
CORBEL-T-4-	230.97	250.21	192.45

**ACANTHUS CORBEL**



**CORBEL-A-2-**  
Medium Acanthus Corbel  
14" L x 5" W x 7" Projection



**CORBEL-A-4-**  
Acanthus Bar Bracket  
13" L x 3-1/2" W x 7-3/4" Projection



**CORBEL-A-5-**  
Low Profile Acanthus Corbel  
6" L x 2-3/4" W x 1-3/8" Projection

<u>Code</u>	<u>AL</u>	<u>MP</u>	<u>RW</u>
CORBEL-A-2-	\$ 278.75	\$ 285.79	\$ 232.51
CORBEL-A-4-	243.78	250.21	211.68
CORBEL-A-5-	70.26	76.68	63.82

**MISSION CORBEL**



**CORBEL-M-2-**  
12" L x 3" W x  
9" Projection



**CORBEL-M-4-**  
12" L x 2-1/2" W x  
6-1/2" Projection

<u>Code</u>	<u>AL</u>	<u>MP</u>	<u>RW</u>
CORBEL-M-2-	\$ 129.60	\$ 146.39	\$ 109.76
CORBEL-M-4-	113.80	125.75	103.39

Wood Species: AL - Alder, MP - Maple, RW - Rubberwood





## WOOD PARTS

## PRIDE



### PRIDE INDUSTRIAL

### DECORATIVE WOOD PARTS

Finely carved architectural wood. All Special Order, Fast Delivery.

#### CORBELS CONT.

**Small Modern  
Craft Corbel**



**CORBEL-T-7-**  
7" L x  
1-3/4" W x  
5" Proj.

**Classic Corbel**



**CORBEL-B-**  
10-7/8" L x  
1-3/4" W x  
8-3/8" Proj.

<u>Code</u>	<u>AL</u>	<u>MP</u>	<u>RW</u>
CORBEL-T-7-	\$ 51.68	\$ 55.05	\$ 43.57
CORBEL-B-	67.37	-	49.06

#### BUNN FEET



**BUNN-8-**  
Square Bunn Foot  
4" x 4" x 4"



**BUNN-1-**  
Round Bunn Foot  
5" x 3"



**BUNN-2-**  
Turned Bunn Foot  
4" x 4"

<u>Code</u>	<u>AL</u>	<u>MP</u>	<u>RW</u>
BUNN-1-	\$ 25.30	\$ 29.81	\$ 26.53
BUNN-2-	25.30	27.13	22.97
BUNN-8-	31.03	33.26	21.80

#### CARVED PEDESTALS



**PED-C-**  
Pedestal Foot Corner  
6-1/2" x 6-1/2" x 4"



**PED-L-**  
Pedestal Foot Left  
6-1/8" x 4" x 2-1/2"



**PED-R-**  
Pedestal Foot Right  
6-1/8" x 4" x 2-1/2"

<u>Code</u>	<u>AL</u>	<u>MP</u>	<u>RW</u>
PED-C-	\$ 50.53	\$ 55.00	\$ 30.86
PED-L-	18.43	21.80	11.58
PED-R-	18.43	21.80	11.58

#### CORK ROLLS

Bulletin Board Cork with a smooth texture, a very close grain, light brown in color. Trimmed and finished edges. Surface finish smooth on both sides.



#232: 3/16" thick x 4' wide, 10' or 60' rolls  
#250: 1/4" thick x 3' wide, 10' or 100' rolls

<u>Code</u>	<u>Length</u>	<u>List/roll</u>
232-10	10'	\$ 284.25
250-10	10'	238.12
250-100	100'	1260.72

Wood Species: AL - Alder, MP - Maple, RW - Rubberwood

## CLOSET TUBING

### KV ROUND CLOSET TUBING



KV 660  
Stainless Steel

KV 660 tubing 1-1/16" O.D. x 29/32" I.D.  
Stainless Steel coated or brass look steel tubing.  
Wall thickness: .087" (2.21mm)

KV 770 tubing 1-1/16" O.D. x 27/32" I.D.  
Chrome look steel tubing.  
Wall thickness: .109" (2.77mm)

KV 770 tubing 1-5/16" O.D. x 1-3/32" I.D.  
Chrome look steel tubing.  
Wall thickness: .109" (2.77mm)

Code	Finish	Length	O.D.	List/ea
660-8	Stainless Steel	8'	1-1/16"	\$ 90.41
660-12	" "	12'	1-1/16"	137.53
770-6-1116	Chrome	6'	1-1/16"	123.64
770-8-1116	" "	8'	1-1/16"	164.93
770-12-1116	" "	12'	1-1/16"	247.29
770-6-1516	" "	6'	1-5/16"	135.58
770-8-1516	" "	8'	1-5/16"	180.67
770-10-1516	" "	10'	1-5/16"	232.09
770-12-1516	" "	12'	1-5/16"	283.99

### SNAP-IN END CAPS FOR 1-5/16" TUBING

Bright Chrome.  
50 per box.



Code	Description	List/ea
732	End Cap for 1-5/16" Tubing	\$ 2.54

## CLOSET HARDWARE

### ECONOMY ROUND CLOSET TUBING



1750 Chrome  
1-5/16" O.D.

### Economy Round Tubing

1-5/16" O.D. x 1-5/32" I.D. Wall thickness: .079"

Code	Length	O.D.	I.D.	List/ea
1750-6	6'	1-5/16"	1-5/32"	\$ 37.71
1750-8	8'	1-5/16"	1-5/32"	47.44
1750-10	10'	1-5/16"	1-5/32"	62.01
1750-12	12'	1-5/16"	1-5/32"	85.32

### HEAVY DUTY CLOSET RODS

Steel, Chrome finish

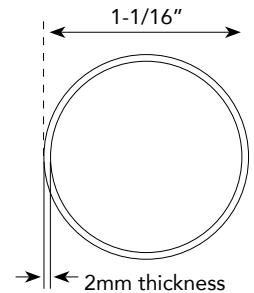

Packed: 5 each/box

Code	Description	List/ea
1116-6CR	1-1/16" x 6', Chrome	\$ 38.90
1116-8CR	1-1/16" x 8', Chrome	42.66
1116-10CR	1-1/16" x 10', Chrome	51.44
1116-12CR	1-1/16" x 12', Chrome	64.73

### ROUND CENTER SUPPORT FOR CLOSET RODS



Chrome plated finish available for 1-1/16" and 1-5/16" diameters.

Oil R Bronze, Satin Nickel and Dull Brass available for 1-5/16" diameter.

Code	Diameter	Finish	List/ea
CRCS-78-CP	1-1/16"	Chrome Plated	\$ 4.51
CRCS-88-CP	1-5/16"	Chrome Plated	8.20
CRCS-88-ORB	1-5/16"	Oil R Bronze	5.96
CRCS-88-SN	1-5/16"	Satin Nickel	6.85
CRCS-88-DB	1-5/16"	Dull Brass	6.85

## CLOSET HARDWARE

### FLANGES FOR 1-1/16 O.D. TUBING



860EP, 83320-CR



850EP, 83340-CR



632KV  
 with  
 5mm pins

Steel flanges for 1-1/16" O.D. steel tubing. Screw holes on 2" centers. Screws included. Chrome or Brass look.

Code	Finish	Description	Ctn	List/ea
860EP	Chrome	Closed Flange	25 ea.	\$ 4.73
83320-CR	Chrome	Closed Flange	50	4.50
850EP	Chrome	Saddle Flange	25	5.59
83340-CR	Chrome	Saddle Flange	50	4.99
632KV	Chrome	End Flange w/ 5mm pins	100	7.40

### FLANGES FOR 1-5/16 O.D. TUBING



861EP



851EP

Flanges for 1-5/16" O.D. steel tubing. Chrome plated steel. With screws.

Code	Finish	Description	Ctn	List/ea
861EP	Chrome	Closed Flange	50 ea.	\$ 9.15
851EP	Chrome	Saddle Flange	25	13.16

### REV-A-SHELF CLOSET RODS AND FLANGES

The 1-5/8" diameter poles are easy to install when using the matching pole caps (sold separately) that snap into standard system 32mm pattern holes.



8' Closet Rods, Chrome finish.

Code	Description	Finish	List/ea
CRSL-96-CR-1	8' L, 1-5/8" dia.	Chrome	\$ 132.02

Dowel mount: 32mm (1-1/4") closet system flanges with 5mm dowel pins. Chrome finish. Mounting hardware included.

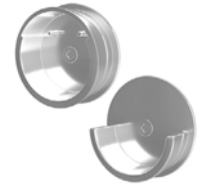

Sold per pair: includes (1) open and (1) closed end cap.

Code	Description	Finish	List/pr
CRCSL-CR-1	Pole end caps	Chrome	\$ 20.45

### ROUND ALUMINUM CLOSET RODS

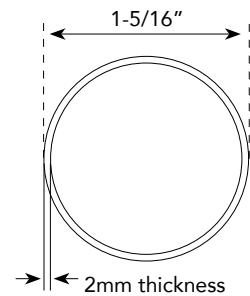
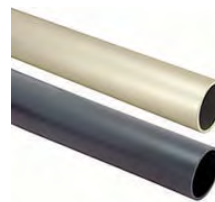

Packed: 20 each/box

Code	Description	List/ea
1516DN-8	1-5/16" x 8', Dull Nickel	\$ 62.54
1516DB-8	1-5/16" x 8', Dull Brass	59.00
1516ORB-8	1-5/16" x 8', Oil R Bronze	93.01
1516MB-8	1-5/16" x 8', Matte Black	62.54

See flanges for above rods next page.

## CLOSET HARDWARE

### FLANGES, SCREW-IN, FOR 1-5/16" ROUND ROD



83310 Closed



83350 Open

Packed: 100 each/box

Code	Description	Finish	List/ea
83310-DN	Closed Flange	Dull Nickel	\$ 6.95
83310-DB	Closed Flange	Dull Brass	6.37
83310-ORB	Closed Flange	Oil R Bronze	7.63
83310-CR	Closed Flange	Chrome	6.68
83310-MB	Closed Flange	Matte Black	7.49
83350-DN	Open Flange	Dull Nickel	\$ 8.43
83350-DB	Open Flange	Dull Brass	8.43
83350-ORB	Open Flange	Oil R Bronze	9.86
83350-CR	Open Flange	Chrome	6.87
83350-MB	Open Flange	Matte Black	7.74

### FLANGES W/ 5MM PINS, FOR 1-5/16" ROUND ROD



83351 Open

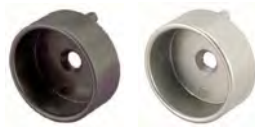

83311 Closed

Code	Description	Finish	List/ea
83311-DN	Closed, w/ 5mm pins	Dull Nickel	\$ 6.00
83311-DB	Closed, w/ 5mm pins	Dull Brass	6.00
83311-ORB	Closed, w/ 5mm pins	Oil R Bronze	5.95
83311-CR	Closed, w/ 5mm pins	Chrome	6.74
83311-MB	Closed, w/ 5mm pins	Matte Black	5.74
83351-DN	Open, w/ 5mm pins	Dull Nickel	\$ 6.07
83351-DB	Open, w/ 5mm pins	Dull Brass	5.56
83351-ORB	Open, w/ 5mm pins	Oil R Bronze	6.08
83351-CR	Open, w/ 5mm pins	Chrome	6.74
83351-MB	Open, w/ 5mm pins	Matte Black	5.74

### KV OVAL CLOSET TUBING



880



881 flange  
 front back

Strong oval shaped tubing is made of heavy gauge steel. Welded seam adds additional strength. Easy to cut. Chrome-look finish. 30mm H x 15mm W x 1.2mm thick.

Flange has 5mm anchor pins to fit 32mm mounting hole patterns. Also has screw hole for extra strength. Chrome look finish. 1-3/4" H x 3/4" W.

Code	Description	Ctn	List/ea
880-8	8' Chrome Oval Tubing	1 ea.	\$ 28.77
881	Flanges for Oval Tubing	50	2.31

### OVAL CLOSET RODS

Seamless Steel, 8' lengths



Chrome Plate  
 Thickness = 1mm

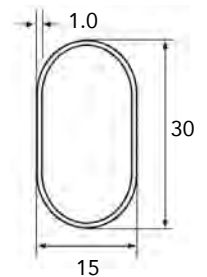

Code	Description	Ctn	List/ea
30X15-8	8' Chrome Oval Tubing	10 ea.	\$ 21.07
30X15-12	12' Chrome Oval Tubing	10	29.60

### FLANGES FOR OVAL RODS

Chrome Plate



C8339  
 w/ 5mm pins

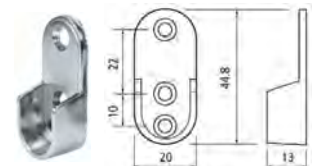

C8339200300  
 no pins

Code	Description	Ctn	List/ea
C8339	Chrome, 5mm pins	1000	\$ 1.07
C8339200300	Chrome, no pins	1000	1.69



## CLOSET HARDWARE

### OVAL ALUMINUM CLOSET RODS



15mm x 30mm,  
1.5mm thick

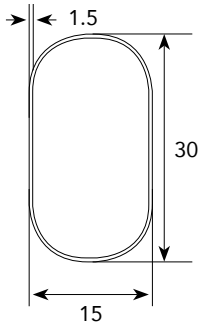

Packed: 20 each/box

Code	Description	List/ea
30X15DN-8	8', Dull Nickel	\$ 39.57
30X15ORB-8	8', Oil R Bronze	39.50
30X15MB-8	8', Matte Black	39.50

### FLANGES FOR OVAL ROD



83391  
5mm pin

83392  
Screw-on

Code	Description	Finish	List/ea
83391DN	5mm pins	Dull Nickel	\$ 2.73
83391ORB	5mm pins	Oil R Bronze	2.73
83391MB	5mm pins	Matte Black	2.66
83392DN	Screw-On	Dull Nickel	\$ 2.53
83392ORB	Screw-On	Oil R Bronze	2.51
83392MB	Screw-On	Matte Black	2.67
CRS-56-BK	5mm pins	Matte Black	\$ 2.02
CRS-54-BK	Screw-On	Matte Black	1.95

### OVAL CENTER SUPPORTS FOR CLOSET RODS

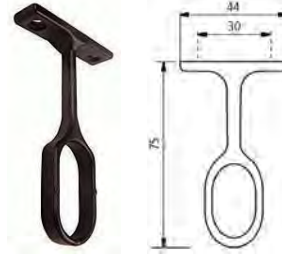

Oval center supports  
Overall length: 2.95"  
(75mm)

Code	Finish	List/ea
661CH	Polished Chrome	\$ 2.50
661DN	Dull Nickel	1.97
661ORB	Oil R Bronze	2.03
CRCS-58-BK	Matte Black	3.61

### KV NO. 2 EXTENSION CLOSET ROD



Adjustable rods to fit closet to 144" wide. Has an improved end flange to simplify installation to hook rail. Rods individually packed in polybags. Bright Nickel Plate Finish. One each per bag.

Code	Description	List/ea
KV2-30	Closet Rod, 30" to 48"	\$ 13.71

### KV No. 29201 CENTER SUPPORT



Fits KV #2 and similar closet rods to provide additional support for heavy loads. Anochrome Finish.

12 ea/box.

Code	Description	List/ea
29201NP	Center Support, 2-41/64" H	\$ 4.32



## CLOSET HARDWARE

### WADDELL HARDWOOD SOCKETS

Hardwood clothes pole sockets are designed to anchor the end of standard 1-3/8" wooden clothes poles. Heavy Duty.



**410R**  
Heavy Duty Socket

<u>Code</u>	<u>Description</u>	<u>Ctn</u>	<u>List/st</u>
410R	Heavy Duty Sockets, 1-3/8"	20 sts	\$ 5.02

### BAINBRIDGE PLASTIC POLE SOCKETS



1323WH

1-3/8" Plastic pole sockets packed 1 pair per bag, 500 bags per box with screws. White plastic.

<u>Code</u>	<u>Description</u>	<u>Ctn</u>	<u>List/pr</u>
1323WH	Plastic Sockets, 1-3/8"	500 pr	\$ 1.22

### CLOSET RODS

Solid Hemlock  
in 8' lengths



138-8

<u>Code</u>	<u>Description</u>	<u>Ctn</u>	<u>List/ea</u>
138-8	1-3/8" x 8' Rods	10 ea.	\$ 48.74

### KV No. 1 CLOTHING CARRIER



KV1

Double the hanging space in any closet with this ball-bearing clothing carrier. Pull, and the entire carrier slides out into the room. A sliding sleeve allows up to 6" adjustment in length. Bright Nickel Plate finish. 1 per box.

<u>Code</u>	<u>Size</u>	<u>Closet Depth</u>	<u>List/ea</u>
KV1-12	12"	to 16"	\$ 67.18
KV1-16	16"	to 20"	68.95

### KV No. 3 GARMENT BRACKET

Heavy duty garment bracket holds 6 or more garments on coat hangers. 1/2" steel rod with safety end welded to heavy steel flange. Anochrome finish. Screws included.



KV3

<u>Code</u>	<u>Size</u>	<u>Ctn</u>	<u>List/ea</u>
KV3-5.5	5-1/2" Length	10 ea.	\$ 28.16
KV3-10	10" Length	10	25.72



## CLOSET HARDWARE

### SHELF & ROD SUPPORT BRACKET



DD06-31WC

- 12-1/2" projection from mounting surface
- Overall size: 15/16" W x 10-1/4" H
- White in color

Shelf and pole bracket is normally used where pole is sagging and a double strength unit cannot be installed. Screws included.

Code	Color	Ctn	List/ea
DD06-31WC	White	20 ea.	\$ 2.94

### ADJUSTABLE SHELF & ROD SUPPORT BRACKET



DD06-32WC

- 12-1/2" projection from mounting surface
- Overall size: 15/16" W x 10-1/4" H
- White in color

For shelves up to 12" wide. Adjustable shelf and pole bracket installs either on a wall or hook strip. White. Screws are included.

Code	Color	Ctn	List/ea
DD06-32WC	White	20 ea.	\$ 5.16

### FIXED SHELF & ROD SUPPORT BRACKET



DD06-33WC

- 12-1/4" projection from mounting surface
- Overall size: 15/16" W x 10-1/2" H
- White in color

Tear drop mounting hole for easy installation. Riveted construction.

Code	Color	Ctn	List/ea
DD06-33WC	White	20 ea.	\$ 5.54

### SHELF & ROD SUPPORT BRACKET

- Available in Chrome, Dull Nickel and Oil Rubbed Bronze
  - Steel, 3mm thickness
  - Shelf material up to 14" deep
  - Load capacity: 110 lbs.
  - Rod fixing hole
- \* Screws not included

#### For Round Rod:

OD:  
10-7/8" H x 12-3/8" D x 1" W



72535-DN  
Dull Nickel finish

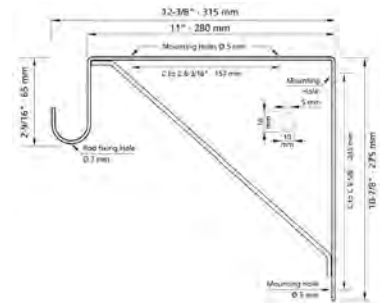

Supports round rod up to 1-5/16" in diameter. All 10 each per Carton.

Code	Description	Finish	List/ea
72535-CR	Round Rod Support	Chrome	\$ 16.57
72535-DN	Round Rod Support	Dull Nickel	10.95
72535-ORB	Round Rod Support	Oil R Brz	11.11

#### For Oval Rod:

OD:  
10-7/8" H x 11-3/4" D x 1" W



190-ORB  
Oil Rubbed Bronze

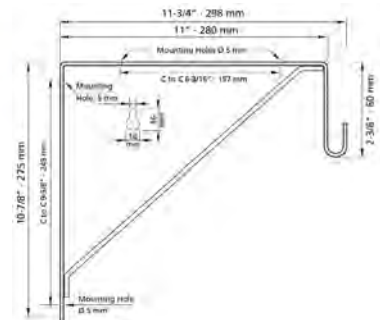

Supports oval rod 30 x 15mm (30X15-8, 880-8 rods) All 10 each per Carton.

Code	Description	Finish	List/ea
185-CR	Oval Rod Support	Chrome	\$ 12.77
188-DN	Oval Rod Support	Dull Nickel	11.61
190-ORB	Oval Rod Support	Oil R Brz	16.75



## CLOSET ACCESSORIES

### PULL-OUT WIRE BASKETS

CB Series - Heavy Gauge Wire Baskets



Bayonet mounting



Chrome 18" x 14" Basket

Heavy-gauge pull-out wire baskets fits 32mm applications. Basket mounting & removal is fast and simple. Basket rests on top of slides, eliminating the torque twist that is inherent in other designs. Bayonet mounting system. Chrome finish. Pack: 5/Carton.

<u>14" Depth</u>	<u>W x H</u>	<u>List/ea</u>
CB-181407CR	18" x 7"	\$ 69.74
CB-181411CR	18" x 11"	82.50
CB-181418CR	18" x 18"	101.82
CB-241407CR	24" x 7"	82.44
CB-241411CR	24" x 11"	94.62
CB-241418CR	24" x 18"	115.67
CB-301407CR	30" x 7"	89.54
CB-301411CR	30" x 11"	100.81
<u>16" Depth</u>		
CB-181607CR	18" x 7"	\$ 80.36
CB-181611CR	18" x 11"	92.76
CB-241607CR	24" x 7"	88.18
CB-241611CR	24" x 11"	118.77
CB-241618CR	24" x 18"	130.90
CB-301611CR	30" x 11"	115.05
CB-301618CR	30" x 18"	137.71
<u>20" Depth</u>		
CB-182007CR	18" x 7"	\$ 94.62
CB-182011CR	18" x 11"	107.85
CB-182018CR	18" x 18"	135.64
CB-242007CR	24" x 7"	106.12
CB-242011CR	24" x 11"	122.36
CB-242018CR	24" x 18"	149.84

### CLOTH HAMPER BAGS FOR CB SERIES BASKETS

Black in Color



Hamper bag insert for use with the CB Series Baskets. Stylish black liner is made of durable, machine washable canvas, features Velcro ties and black coated handles.

Pack: 5/Carton.

<u>Code</u>	<u>Dimensions</u>	<u>List</u>
CHBI-241618	For 24" W x 16" D x 18" H	\$ 61.15

### CLOTH LINERS FOR CB SERIES BASKETS

Cloth basket liners are machine washable and designed to fit tight and secure in Rev-A-Shelf CB Series baskets. With hook and loop fasteners. All tan in color except where noted.



<u>14" Depth</u>	<u>Dimensions</u>	<u>Color</u>	<u>List</u>
CBL-181418-T	18"W x 14"D x 18"H	Tan	\$ 46.71
<u>16" Depth</u>			
CBL-241611-B-1	24"W x 16"D x 11"H	Black	38.92





## CLOSET ACCESSORIES



### TOP MOUNT BRACKET FOR CB SERIES BASKETS



CTMB-18

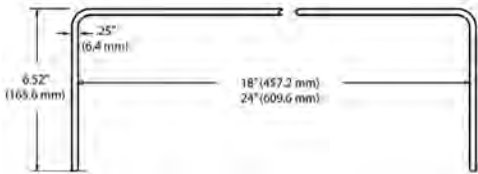

This top mount bracket mounts CB Series wire baskets in openings that are not the standard 18" widths. Simply mount the bracket to the underside of a shelf and then attach the basket to the brackets. Min. opening 18-1/2".

Pack: 5 pr/Cartron.

Code	Description	Min. Opening	List/pr
CTMB-18	For 18" Basket	18-1/2"	\$ 32.06

### TILT-OUT HAMPER BASKET

CTOHB Series



Door mount the basket to a bottom hinged cabinet for easy one step "Slide-In/Slide-Out" basket removal. 6.6mm wire, has a capacity of 55 qts for the 16" wide unit and 74 qts for the 21" wide unit. All models 13-1/2" D and 19-3/4" H.

Code	Width	Finish	List
CTOHB-161319-CR	15-1/2"	Chrome	\$ 136.88
CTOHB-211319-CR	20-1/2"	Chrome	163.83
CTOHB-161319-SN	15-1/2"	Satin Nickel	129.17
CTOHB-211319-SN	20-1/2"	Satin Nickel	141.87
CTOHB-161319-ORB	15-1/2"	Oil R Bronze	129.17
CTOHB-211319-ORB	20-1/2"	Oil R Bronze	138.71

### Removable Hamper Bags for CTOHB Baskets

Machine washable Black or Tan Cloth Liners. Fits tight with hook and loop fasteners. Strong handles.



Code	Description	List/ea
CTOHB-16-I-1	Black Liner for 16" Basket	\$ 58.95
CTOHB-21-I-1	Black Liner for 21" Basket	75.43
CTOHT-16-I-1	Tan Liner for 16" Basket	72.94
CTOHT-21-I-1	Tan Liner for 21" Basket	76.90

### REV-A SHELF SLIDE-OUT HAMPER

Removable hamper that includes detachable lid.

One 63 Qt polymer hamper with frame and full extension slides. Fully assembled.

Dimensions:  
19-7/8"W x 14"D x 24"H



HPRV-1925DMS

### WIRE HAMPER WITH SOFT-CLOSE SLIDES

CH Series



CH-241419-RM-217



5CHB-LINER  
(Sold Separately)

- Two removable wire baskets and machine washable cloth liners.
- Silver polymer base
- Bottom mount full extension slides
- Soft-Open/Soft Close Rev-A-Motion™ technology
- Includes door mount brackets



24" W x 13-15/16" D x 18-7/8" H

Code	Description	List/ea
CH-241419-RM-217	Double Wire Hamper w/ 2 Canvas Liners	\$ 636.63
5CHB-LINER	Replacement Liners	27.48

Code	Description	List
HPRV1925S	Slide-out hamper	\$ 196.67
HPRV-1925DMS	Slide-out hamper w/ Door mount brackets	238.40



## CLOSET ACCESSORIES

### WIRE SHOE RAIL

CSR Series



Add functionality to your closets. Available in 17", 23", 29" and 35" lengths, this shoe rail system is easy to install and features heavy gauge railing. Height: 2-1/4".

Available in Chrome, Satin Nickel and Oil Rubbed Bronze finishes. Pack: 10 ea/box.

<u>Code</u>	<u>Length</u>	<u>Finish</u>	<u>List/ea</u>
CSR-17CR	17"	Chrome	\$ 10.40
CSR-23CR	23"	Chrome	12.64
CSR-29CR	29"	Chrome	15.93
CSR-35CR	35"	Chrome	15.98
CSR-17SN	17"	Satin Nickel	9.52
CSR-23SN	23"	Satin Nickel	11.53
CSR-29SN	29"	Satin Nickel	12.64
CSR-35SN	35"	Satin Nickel	13.75
CSR-23ORB	23"	Oil R Bronze	11.53

### WIRE FAN PANTS RACK

CPRF Series

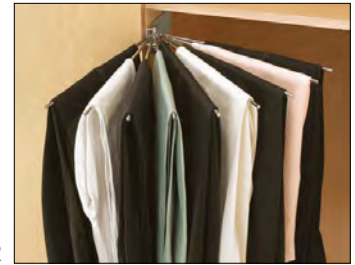

CPRF-16CR

Chrome plated fan pants rack. Simple installation via the system holes, universal left or right side wall mounting. For an 18" width x 16" deep opening. An easy way to add storage for nine pairs of pants. Rubber O-rings keep pants from slipping, polished ends prevent snagging.

<u>Code</u>	<u>Description</u>	<u>List/ea</u>
CPRF-16CR	Pants rack, Chrome	\$ 57.84

### SOLID WOOD DISPLAY PANTS RACK

CWPR Series

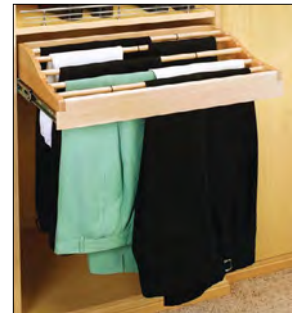

CWPR Pants Rack  
 24", 30"

These pull-out racks feature full-extension slides, rubber O-rings to prevent slipping and removable pant rods for ease of use. Made from solid birch/maple. Removable front for drawer head mounting. All models 14-3/8" deep and 6" high. Clear Finish.

Pants rack comes in a 24" or 30" width and has space for 18 standard or 12 Big & Tall pants. Removable pant rods for ease of use.

<u>Code</u>	<u>Description</u>	<u>Width</u>	<u>List/ea</u>
CWPR-2414	24" Pants Rack	24"	\$ 191.59
CWPR-3014	30" Pants Rack	30"	211.65

## CLOSET ACCESSORIES



### PULL-OUT PANTS RACK

PSC Series

- Heavy gauge chrome
- Pull-out frame with moveable 'fingers' for easy access
- Full extension slides

14" Depth, 3" Height



Code	Width	Capacity	List/ea
PSC-1814CR	17-1/2" - 18-1/8"	9 pair	\$ 137.97
PSC-2414CR	23-3/4" - 24-1/2"	13 pair	168.56
PSC-3014CR	29-3/4" - 30-1/2"	16 pair	210.78

### PULL-OUT PANTS RACK

PSCSL Series

- 2 available widths: 24" and 30"
- 14" deep non-slip hanger arms per rack
- Full extension, soft-closing, ball-bearing steel slides

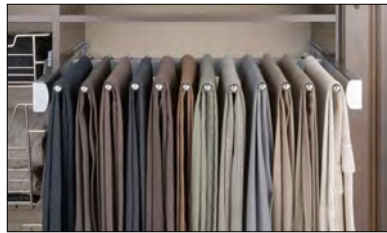

14" Depth, 2-1/2" Height

Code	Width	Finish	List/ea
PSCSL-2414SC-SN-1	24", 12 arms	Sat Nickel	\$ 327.83
PSCSL-3014SC-SN-1	30", 15 arms	Sat Nickel	376.75

### PULL-DOWN CLOSET ROD

CPDR Series



CPDR-2635

Pull-Down Closet Rod is available in 3 sizes and features an adjustable rod length to accommodate openings from 18" to 26" (CPDR-1826), 26" to 35" (CPDR-2635) and 35" to 48" (CPDR-3548). The telescoping pull-rod adjusts from 34" to 50" to accommodate universal design and handi-cap accessible applications. Chrome and black.

Code	Description	List/ea
CPDR-1826	21-1/2" - 26"	\$ 206.41
CPDR-2635	26" - 35"	205.68
CPDR-3548	35" - 48"	212.98

### GLIDEWARE VALET HANGER PULL-OUT

GLD-CV Series

- Designed for 14" depth closet cabinets
- Solid wood maple construction
- Full extension, 110 lb, soft-close slides
- Chrome valet rail with scallops
- Mounts to ceiling and rear
- Push/pull bar included



6" W X 14" D X 16-3/16" H

Code	Description	List/ea
GLD-CV14B-1	Hanger pull-out, soft-close	\$ 263.30



## CLOSET ACCESSORIES

### JEWELRY DRAWERS

CJD Series

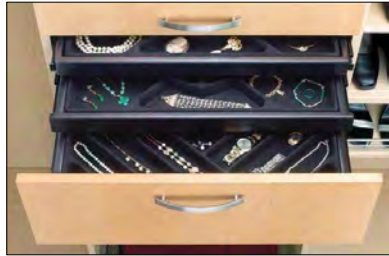

Shown drawer front mounted with multiple jewelry drawers / inserts.

CJD-24IN  
 (w/ Necklace Insert)



CJD-24IS  
 (w/ Jewelry Insert)

Keeps jewelry organized; easily installed with system holes and features black full-extension ball-bearing slides. Drawer head mounting capability. Use in coordination with the CJD-24IS (Jewelry) and CJD-24IN (Necklace) inserts.

These unique inserts store large items like necklaces without tangling. The curved inside radius allows full access to small items such as earrings and rings. Inserts feature "drop-in" installation and a soft, velvet flocked covering.

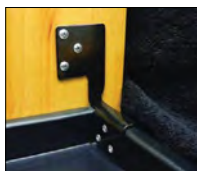

CJD-DMB-KIT

Optional Drawer Front Mount Kit (Sold Separately).

Code	Dimensions
CJD-2414	24" W x 14" D x 1-7/8" H
CJD-24IS	22" W x 13" D x 1-1/2" H
CJD-24IN	22" W x 13" D x 1-1/2" H

Code	Description	List
CJD-2414	Jewelry Drawer w/Slides	\$ 105.52
CJD-24IS	Jewelry Insert	76.41
CJD-24IN	Necklace Insert	77.65
CJD-DMB-KIT	Drawer Front Mount Brkt	6.44

### PULL-OUT CLOSET MIRROR

CMSL Series



Pulls out smoothly and swivels 90°



This Pull-out Swivel Closet Mirror makes space where none exists for a wardrobe mirror. Fastening to a side wall or a panel, mirror uses only 3" of horizontal storage space, about the same as a stowed ironing board tucked away. When needed, pull out on full-extension, soft-close ball-bearing slides and then swivel 90° to face you. When you are finished viewing, simply pivot it back and give it a nudge to return it to its hiding place.

- Full body image when standing 24" from the mirror
- Adjustable height to meet the viewer's needs
- Fits any partition at least 14" deep and 8" wide
- Allow 5.75" for swiveling clearance
- Pulls out smoothly and swivels 90 degrees
- Can be installed behind cabinet doors
- Universal, non-handed
- Soft-close retracting mechanism requires only a gentle push

Dimensions:  
 1-7/8" W x 13" D x 48" H

Code	Finish	List/ea
CMSL-1448-SM-1	Silver Mist	\$ 500.45

## CLOSET ACCESSORIES



### STANDARD VALET ROD

CVL Series

12" Length

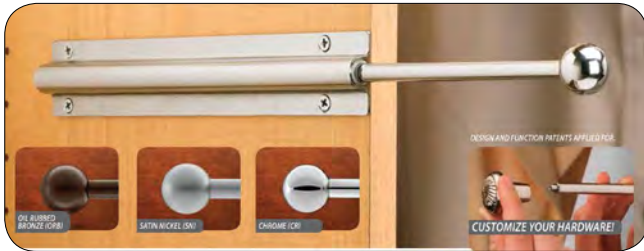

12" Standard Valet Rod installs easily with only four screws. Offered in Chrome, Satin Nickel, and Oil Rubbed Bronze, and features unique removable pull for easy customization to your current closet hardware. (8/32" thread)

Rod Dimensions: 11-7/8" to 17-7/8" Length.

Code	Finish	List/ea
CVL-12CR	Chrome	\$ 27.62
CVL-12SN	Satin Nickel	26.01
CVL-12ORB	Oil R Bronze	26.01

### DESIGNER VALET ROD

CVR Series

14" Length

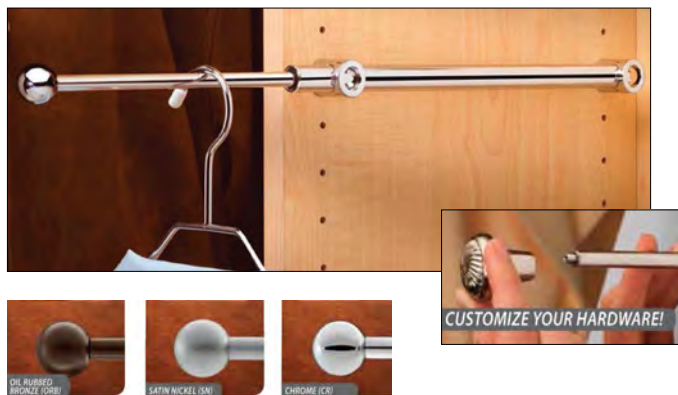

Designer Valet Rod has an 8-3/16" telescoping rod. For 14" depth closet panels. Adjustable mounting bracket for various system hole applications. Removable knob to customize hardware (8/32" thread)

Rod Dimensions: 13-7/8" to 21-7/8" Length.

Code	Finish	List/ea
CVR-14CR	Chrome	\$ 43.23
CVR-14SN	Satin Nickel	40.50
CVR-14ORB	Oil R Bronze	40.50

### POP-OUT VALET ROD

CVLPOSL Series

14" Length



- One-touch pop-out mechanism
- Fits panel depths of 14" or greater
- 10mm dia. rod extends 7.5"
- Holds up to 35 lbs.

Code	Finish	List/ea
CVLPOSL-14-CR-1	Chrome	\$ 73.44
CVLPOSL-14-SN-1	Satin Nickel	103.66

### INSERT VALET ROD

CVRI Series

Rod can open or close the 3-1/3" with a single finger. Fits within 3/4" and larger closet panels.

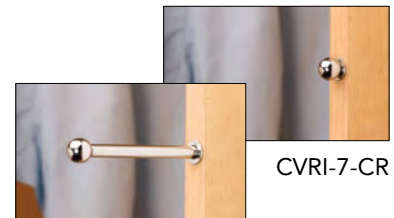

Dimensions: 3-3/4" - 7-3/8" L. Chrome or Satin Nickel.

Code	Description	Finish	List/ea
CVRI-7-CR	Insert Valet Rod	Chrome	\$ 26.63
CVRI-7-SN	Insert Valet Rod	Satin Nickel	25.77



## CLOSET ACCESSORIES

### CLOSET ORGANIZERS

CTR / CBSR Series



CTR - Tie/Scarf Organizer

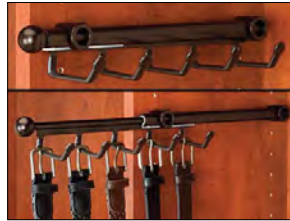

CBSR - Belt/Scarf Organizer

Easily installs  
 with two Euro  
 screws.



Tie/Scarf Organizer holds up to 15 ties or scarves and Belt Organizer holds up to six belts. Both feature clear non-slip soft PVC coated hooks. Fully accessible 8-3/16" telescoping rod. For 14" depth closet panels. Adjustable mounting bracket for various system hole applications. Removable knob to customize hardware (8/32" thread).

Rod Dimensions: 13-7/8" to 21-7/8" Length.

Code	Organizer	Finish	List/ea
CTR-14CR	Tie/Scarf	Chrome	\$ 80.25
CTR-14ORB	" "	Oil R. Bronze	76.53
CBSR-14CR	Belt/Scarf	Chrome	62.73
CBSR-14SN	" "	Satin Nickel	60.79
CBSR-14ORB	" "	Oil R. Bronze	63.55

### PULL-OUT SIDE MOUNT TIE RACK

TRC Series

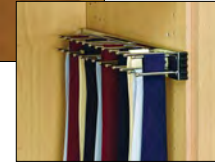

- Holds up to 25 ties
- Full extension ball-bearing slide

- Available in Chrome, Satin Nickel or Oil Rubbed Bronze

Dimensions:

2-1/2" W x 14" D x 1-7/8" H

Code	Finish	List/ea
TRC14CR	Chrome	\$ 36.28
TRC-14SN	Satin Nickel	34.55
TRC-14ORB	Oil R Bronze	34.56

### PULL-OUT SIDE MOUNT BELT RACK

BRC Series



BRC-14  
 Belt Rack w/  
 Nine hooks

Pull-out belt storage system - available in three finishes. Designed to hold belts neatly, is completely accessible and fits any 14" depth closet application.

Dimensions:

2-1/2" W x 14" D x 1-7/8" H

Code	Finish	List/ea
BRC-14CR	Chrome	\$ 39.68
BRC-14SN	Satin Nickel	31.12
BRC-14ORB	Oil R Bronze	33.26



# HOOKS

# SUGATSUNE

## STAINLESS STEEL HOOKS

Mirror finish and supplied with stainless steel screws



Load Cap: 44 lbs.

Code	Overall Proj.	Ht	Pk	List/ea
EL25*	1-1/16"	1-7/16"	60	\$ 14.15
EL30	1-5/16"	2-3/16"	40	19.21

EL Series

\*Special Order when out.



Load Cap: 44 lbs.

Code	Overall Proj.	Ht	Pk	List/ea
EP25	1"	1"	30	\$ 14.15
EP40	1-5/16"	1-3/8"	20	11.93

EP Series



FC Series

Code	Proj.	Ht	Load Cap	Pk	List/ea
FC50	1-7/8"	1-1/2"	22 lbs.	30	\$ 18.20
FC65	2-9/16"	1-3/4"	26	20	21.23

## STAINLESS STEEL HOOKS

Polished stainless steel finish



TY Series

Code	Hook Proj.	Hook Ht	Screw Length	Load Cap	Ctn	List/ea
TY-25	1-1/16"	11/16"	13mm	6.6 lbs	100	\$ .71
TY-30	1-7/32"	13/16"	15mm	15.4	100	.81
TY-35-15	1-7/16"	15/16"	20mm	15.4	50	1.11
TY-40-15	1-23/32"	1-1/16"	20mm	17.6	50	1.52



TF Series

Code	Hook Proj.	Hook Ht	Screw Length	Load Cap	Ctn	List/ea
TF-20	13/16"	13/16"	11mm	6.6 lbs	200	\$ .71
TF-30	1-5/32"	1-1/32"	15mm	15.4	100	1.31
TF-35	1-5/8"	1-3/8"	20mm	26	50	1.72



TL Series

Code	Hook Proj.	Hook Ht	Screw Length	Load Cap	Ctn	List/ea
TL-20	29/32"	25/32"	11mm	11 lbs	100	\$ .71
TL-30	1-5/32"	1"	15mm	11	100	1.01
TL-40	1-19/32"	1-11/32"	20mm	26	50	1.82

## STAINLESS STEEL SWING HOOKS

With Friction



- Swivels 180 degrees
- Hook has constant torque when swiveling
- Ideal for vibration or shock applications
- Screws included
- Polished stainless steel finish

Code	Overall Ht	Proj	Overall Width	Load Cap	Ctn	List/ea
TK-30F	.57"	1-27/64"	1-3/8"	26 lbs	100	\$ 4.35
TK-45F	.76"	1-3/4"	1-3/8"	17	100	4.75



## CLOSET HOOKS

### BERENSON COAT HOOKS



8012-BPN-P  
Brushed Nickel

Height: 4"  
Width: 3/8"  
Proj: 3-1/16"

8016-VB-P  
Verona Bronze

Code	Finish	List/ea
8012-BPN-P	Brushed Nickel	\$ 12.61
8016-VB-P	Verona Bronze	20.06

### IVES SINGLE WARDROBE HOOK

Base: 1-1/8" x 1-1/8"  
Proj: 1-11/16"



Code	Finish	Ctn	List/ea
SP581A92	Aluminum	25 ea	\$ 2.12
SP581A3	Polished Brass	25	1.42

### IVES DOUBLE WARDROBE HOOK

Base: 1-1/8" x 1-1/8"  
Proj: 1-1/8"



Code	Finish	Ctn	List/ea
SP582A92	Aluminum	25 ea	\$ 2.31
SP582A3	Polished Brass	25	2.65

### IVES COAT HOOKS

Cast Metal

Base: 1-3/4" H x 1-1/4" W  
Proj: 3"



Code	Finish	Ctn	List/ea
SP571A92	Aluminum	25 ea	\$ 1.70
SP571A3	Polished Brass	25	1.82
SP571A5	Antique Brass	25	2.54
571AW	White	10	2.95

## PEGS

### IVES CEILING HOOK

Base: 1" H x 1-7/8" W  
Proj: 2-1/4"



Code	Finish	Ctn	List/ea
SP580A92	Aluminum	25 ea	\$ 3.15
SP580A3	Polished Brass	25	2.74

### WOODEN HANGING PEGS



Hardwood Shaker Pegs, unfinished. An ideal peg for hanging coats, hats, etc. Overall Length: 3-1/2". Head Dia: 1", Base Dia: 3/4", Stem Dia: 1/2".

Code	Packaging	Ctn	List/bg
CP4	2 ea/ polybag	12 bgs	\$ 3.52

Oak Shaker Pegs:

CP9	1 ea/ polybag	12 bgs	\$ 4.52
-----	---------------	--------	---------

Mini Shaker Pegs: O/A Length: 2"

CP11	3 ea/ polybag	12 bgs	\$ 3.52
------	---------------	--------	---------

### SHAKER PEGS

Birch wood. 100/box.



Code	Size	List/C
HP-1BIR	3-1/2" x 7/8" x 1/2" stem	\$ 40.36
CP-1BIR*	5-1/8" x 1-1/4" x 3/4" stem	92.00

\*disc when out

### SCREW-ON SHAKER PEGS

Birch wood. 100/box.



Code	Size	List/C
HP-1SCR	3-1/2" x 7/8" x #10 screw	\$ 117.22



## HANDRAIL BRACKETS

### IVES HANDRAIL BRACKETS



Code	Size	Base to Center of rail
059	2-1/4"H x 1-3/8"W	2-7/16"
59	2-13/16"H x 1-1/2"W	2-3/4"

#### Plated Steel. Polybagged with screws

Code	Finish	Ctn	List/ea
59A10B	Oil R Bronze	10 bgs	\$ 8.48
59A15	Satin Nickel	10	7.00
SP59A3	Polished Brass	15	6.41
SP59A92	Aluminum	15	5.81
059AW	White	10	6.63
SP059A92	Aluminum	20	5.03
059A10B	Oil R Bronze	20	4.23
SP059A3	Polished Brass	20	5.14

#### Solid Brass

Code	Finish	Ctn	List/ea
59MB26	Polished Chrome	10 ea.	\$ 28.51
59MB15	Satin Nickel	10	29.72
59MB3	Polished Brass	10	28.11
059B15	Satin Nickel	10	53.45
SP059B10B	Oil R Bronze	10	34.48

### PARKER HANDRAIL BRACKET

#### Solid Brass

Solid cast brass handrail brackets. Projection is 3". For 2" O.D. tubing.

Includes 3" projection stud. Polished Brass finish.



Code	Finish	Ctn	List/ea
180S-2	Polished Brass	5	\$ 41.36

### DELTA HANDRAIL BRACKETS

#### Solid Brass - For Flat Rail

#### HRC175

Projection: 3-3/16"  
 Base Size: 2-1/4" Dia.

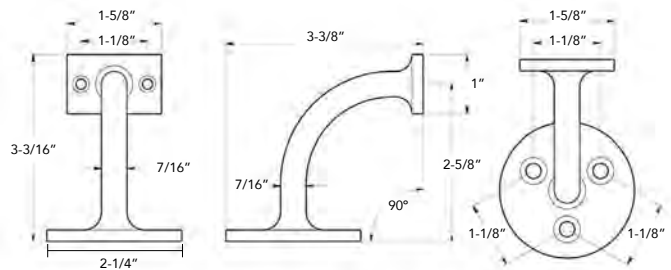

#### HRC253

Projection: 3"  
 Base Size: 2-1/4" Dia.

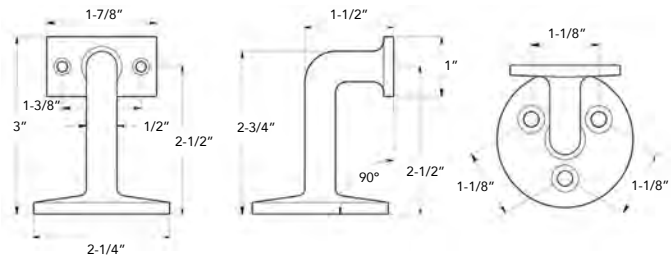

Code	Finish	Proj.	List/ea
HRC175U15	Satin Nickel	3-3/16"	\$ 48.19
HRC175U10B	Oil R Bronze	3-3/16"	48.19
HRC253US3	Pol. Brass	3"	34.21
HRC253U15	Satin Nickel	3"	36.36



# LAVI

# BAR RAILING

## LAVI SOLID BRASS BAR RAILING AND FITTINGS

All in Polished Brass Finish. Screws included.

Stainless Steel available Special Order.

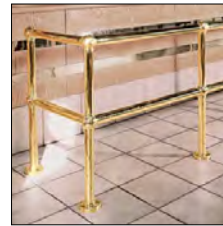

### BRASS RAILING



Polished brass finish.  
.050 thickness. 1-1/2" or 2"  
O.D. Available in 6' or 12'  
lengths only.

Code	O.D.	Length	List/ea
A110-00-6	1-1/2"	6'	\$ 268
A110-00-12	1-1/2"	12'	524
A120-00-6	2"	6'	388
A120-00-12	2"	12'	766

### HANDRAIL BRACKET

112 for  
1-1/2" rail.  
2 for 2" rail.

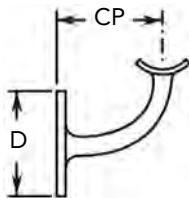

Code	CP	D	List/ea
301-112	2-3/4"	2-1/2"	\$ 39
301-2	2-5/8"	2-1/2"	41

### FLUSH END POST (Closed End)

112 for  
1-1/2" rail.  
2 for 2" rail.

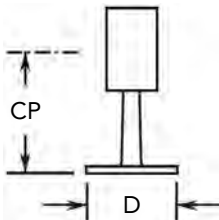

Code	CP	D	List/ea
340-112	2-7/16"	2-5/16"	\$ 41
340-2	3-1/4"	2-1/2"	43

Recommended: Footrail bracket every 3' of rail.  
Handrail bracket every 3-4' of rail.

### FLUSH CENTER POST

112 for  
1-1/2" rail.  
2 for 2" rail.

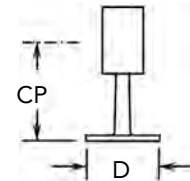

Code	CP	D	List/ea
342-112	2-7/16"	2-5/16"	\$ 40
342-2	3-1/4"	2-1/2"	45

### FOOTRAIL BRACKET

112 for  
1-1/2" rail.  
2 for 2" rail.

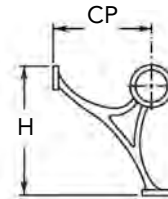

Code	CP	H	List/ea
400-112	6-1/8"	6-1/4"	\$ 51
400-2	6-3/8"	7"	77

### BAR MOUNT BRACKET

112 for  
1-1/2" rail.  
2 for 2" rail.

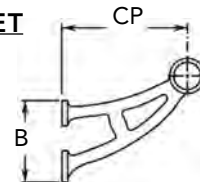

Code	CP	B	List/ea
402-112	6-1/16"	4"	\$ 62
402-2	6-7/8"	4-1/4"	73

### FLOOR BRACKET

For 2" rail.

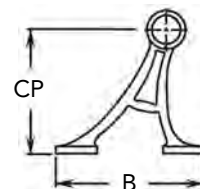

Code	CP	B	List/ea
404-2	8-3/8"	4-11/16"	\$ 65

**BAR RAILING**

**LAVI**

**LAVI SOLID BRASS  
 BAR RAILING AND FITTINGS**

All in Polished Brass Finish. Screws included.

Stainless Steel available Special Order.



**BALL  
 ELBOW**

112 for  
 1-1/2" rail.

2 for 2" rail.

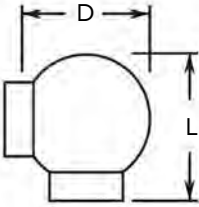

List/ea  
 Call  
 \$ 55

Code	D	L
702-112*	2-1/2"	3"
702-2	3-1/4"	3-3/4"

**BALL  
 FINIAL**

112 for 1-1/2" rail.  
 2 for 2" rail.

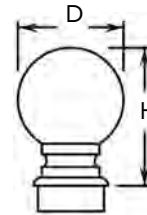

Code  
 604-112  
 604-2

D	H
2-5/8"	3-1/4"
3-1/8"	4-1/2"

List/ea  
 \$ 55  
 61

**FLUSH RADIUS  
 ELBOW**

112 for  
 1-1/2" rail.

2 for 2" rail.

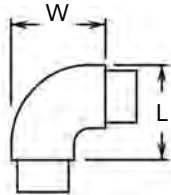

List/ea  
 \$ 62  
 62

Code	W	L
731-112	2-7/8"	2-7/8"
731-2	3"	3"

**WALL  
 FLANGE**

112 for 1-1/2" rail.  
 2 for 2" rail.

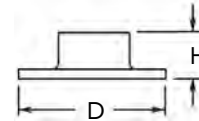

Code  
 510-112  
 530-2

D	H
3"	1-1/4"
4"	1-1/4"

List/ea  
 \$ 23  
 33

**FLUSH END CAP**

112 for  
 1-1/2" rail.

2 for 2" rail.

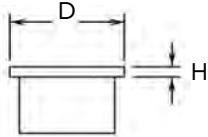

List/ea  
 \$ 10  
 18

Code	D	H
600-112	1-1/2"	1/8"
600-2	2"	1/8"

**FLOOR  
 FLANGE**

112 for 1-1/2" rail.  
 2 for 2" rail.

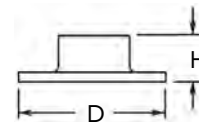

Code  
 512-112  
 532-2

D	H
4"	1-1/4"
5"	1-3/8"

List/ea  
 \$ 35  
 37



## MACK WALLBEDS

The MACK EUROBED™ is a fully adjustable progressive tensioning bed mechanism of commercial quality. Frames are shipped fully assembled so minimal shop time is required. Easy to install - all installation hardware is included.

All frames are shipped with a fine quality innerspring mattress designed to meet weight specifications of the bed frame, mattress & bedface when installed. Mattress rests on steam-bent, laminated birch slats. The slats offer more support than a box spring and are just as comfortable. You can leave your sheets, blankets and pillows on the bed when you close it.

Sizes available: Twin, Twin X-long, Full, Full X-long and Queen.

Frame colors available: Black (BL), White (WH), Almond (AL), and Terra Cotta (TC). All with matching vinyl pillow pad.



(Cabinetry not included)

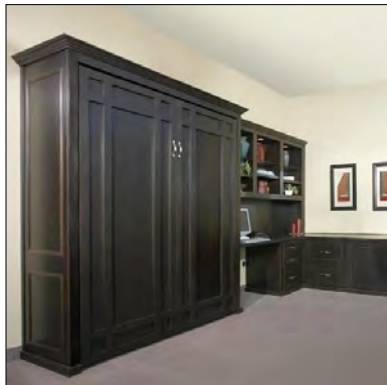

(Cabinetry not included)

### Net Clear Opening Requirements (Recess Depth is Minimal at 18-5/8")

<u>Code</u>	<u>Size</u>	<u>Opening Width</u>	<u>Opening Height</u>	<u>Min. Recess Depth</u>	<u>Projection from Face of Cabinetry when Open</u>	<u>List</u>
4182*	Twin	41"	78-7/8"	18-5/8"	68-3/8"	\$ 4662
4187*	Twin Long	41"	83-7/8"	18-5/8"	73-5/16"	4845
5682*	Full	56"	78-7/8"	18-5/8"	68-3/8"	4845
5687*	Full Long	56"	83-7/8"	18-5/8"	73-5/16"	5100
6387*	Queen	62-1/2"	83-7/8"	18-5/8"	73-5/16"	5100

Upgrade to Royal Plush Mattress: add \$ 200 List  
Upgrade to Silver Plush Mattress: add \$ 224 List  
Upgrade to Temperselct Mattress: add \$ 933 List

Indicate Frame Color: BL, WH, AL or TC

\* **Special Order.** F.O.B. Petaluma, CA. Most items 1 to 3 week lead time. (Twin Long, Full Long and black frames 3 to 6 weeks.) Construction video tape and shop site demos available.



## COMMERCIAL BATHROOM ACCESSORIES

## AMER SPEC INC

### AUTOMATIC ROLL PAPER TOWEL DISPENSER

Special Order



Proximity sensing no-touch unit dispenses pre-set lengths per cycle from 8" or 9" (205 or 230 mm) wide, 800' (244 m) long rolls. Battery operated (4) D-size.

Overall Size  
13" X 17-3/4" X 10"

<u>Code</u>	<u>Description</u>
8523A*	Automatic Paper Towel Dispenser

Call for Price

### COMBINATION PAPER TOWEL DISPENSER & DISPOSAL

Special Order

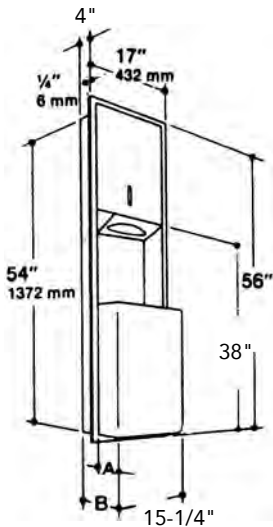

Recessed for 4-1/4" wall depth. Door and frame are 22 gauge stainless steel, satin finish. Capacity: 600 C-fold or 800 multi-fold towels. Waste Container: 12 gallons. A: 4-1/4", B: 8-1/4". Wall opening: 15-3/4" x 54-1/2" x 4-1/4".

<u>Code</u>	<u>Description</u>
0469*	Combination Paper Towel Dispenser & Disposal

Call for Price

### PAPER TOWEL DISPENSER

Special Order



Surface mounted, 22 gauge stainless steel, satin finish with tumbler lock. Capacity: 400 C-fold or 525 multi-fold towels. Fitted with tumbler lock and heavy duty stainless steel piano hinge.

Overall Size  
11" x 14 5/8" x 4 1/16"

<u>Code</u>	<u>Description</u>
0210*	Paper Towel Dispenser

Call for Price

### TOILET SEAT COVER DISPENSER

Special Order



Surface Mounted, 22 gauge Stainless steel, satin finish. Capacity: 250 covers.

Overall Size  
15-3/4"W x 11-1/4"H x 2-5/8"D

<u>Code</u>	<u>Description</u>
0477-SM*	Seat Cover Dispenser

Call for Price

### FEMININE NAPKIN DISPOSAL

Special Order



Surface Mounted, 22 gauge stainless steel with satin finish. Sloping cover mounted w/ piano hinges. Capacity: .9 gallons (.12 cu ft.)

Overall Size  
7-1/2" W X 10" H x 3-7/8" D

<u>Code</u>	<u>Description</u>
0852*	Feminine Napkin Disposal

Call for Price



## AMER SPEC INC

## COMMERCIAL BATHROOM ACCESSORIES

### SOAP DISPENSERS

Special Order



# 0345



# 0347

Stainless Steel, #4 satin finish. All purpose soap valve and unbreakable refill window. Concealed fastening and hinged filler-top. Capacity: 40 fluid ounces (1.2 L).

#### 0345 Horizontal Soap Dispenser

Overall size: 8-1/8" W x 4-3/4" H x 4" projection.

#### 0347 Vertical Soap Dispenser

Overall size: 4-3/4" W x 8-1/8" W x 5-1/4" projection.

<u>Code</u>	<u>Description</u>
0345*	Horizontal Soap Dispenser
0347*	Vertical Soap Dispenser

Call for Price

### AUTOMATIC FOAM SOAP DISPENSER

Special Order

A foam drop is dispensed out of the nozzle on unit bottom each time its battery-operated sensor is activated. Capacity: 34 oz. (1000 ml) of liquid foaming soaps within a wide range of viscosity.



# 20365

5 1/2" x 10 7/8" x 4" projection.

<u>Code</u>	<u>Description</u>
20365*	Foam Soap Dispenser

Call for Price

### TRI-Umph™ HIGH-SPEED HAND DRYER

Special Order

Overall Size

12-43/64" W x 23-1/8" H x 7-3/4" D



# 20200

- Quick drying — about 12 seconds
- Ergonomic — No need to bend over or bend knees
- Air blows down and back from vents on three sides
- No water splash-back: water from hands is pushed backwards onto absorbent ceramic plate...not the floor
- Ultra hygienic — Over 99% of airborne bacteria is eliminated with the three-layer, removable Super Filter System, consisting of a HEPA filter, a carbon filter and an anti-microbial filter. Anti-microbial silver sodium added to the ABS cover provides an additional layer of germ protection
- Owner-adjustable heater (on or off) and air flow

<u>Code</u>	<u>Description</u>
20200-1*	High Speed Hand Dryer, 110 - 120V
20200-2*	High Speed Hand Dryer, 208 - 240V

Call for Price

12



## AMER SPEC INC

## COMMERCIAL BATHROOM ACCESSORIES

### DUAL ROLL TOILET TISSUE DISPENSER

Special Order

Surface Mounted  
Stainless Steel

Holds two rolls up to 5-1/4" dia. Stainless Steel cabinet. Theft resistant spindles.



Code                      Description  
0030\*                      Tissue Dispenser

**Call for Price**

### SINGLE TOILET TISSUE HOLDER

Special Order

Surface Mounted  
Chrome Plated Steel.  
With vandal resistant locking device.

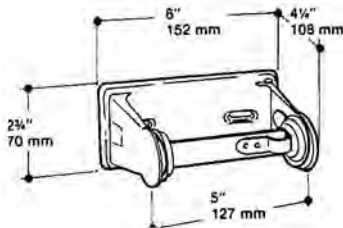

Code                      Description  
0710\*                      Single Roll Holder

**Call for Price**

### DOUBLE TOILET TISSUE HOLDER

Special Order



Surface mounted. Plated steel with a bright chrome finish. Heavy duty brake springs provide controlled delivery. Vandal resistant locking device.  
Overall: 12-3/8" L x 2-3/4" H x 4-1/4" D

Code                      Description  
0715\*                      Double Roll Holder

**Call for Price**

### COMMERCIAL GRAB BARS

In Stock

Stainless Steel

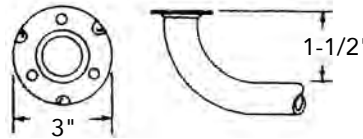

Projection from wall: 1-1/2", Flange Dia: 3"

- Type 304 Satin Stainless Steel Bar with .050" wall thickness (18 Gauge)
- Mounting flanges with .073" wall thickness (14 Gauge)
- Flanges are 3" Diameter with 3 hole mounts
- 2" Stainless Steel mounting screws
- 1-1/2" wall clearance on all bars to meet ADA Code Requirements
- Tested to withstand 1000 lbs. Pull/Push when properly installed

<u>Code</u>	<u>Size</u>	<u>List/ea</u>
BGBSS-1218E	18"	\$ 46.77
BGBSS-1224E	24"	56.81
BGBSS-1230E	30"	43.11
BGBSS-1236E	36"	51.23
BGBSS-1242E	42"	55.92
BGBSS-1248E	48"	56.17

### STAINLESS STEEL CHANNEL FRAMED MIRROR

Special Order

- 0620 - Without Shelf
- 0625 - With Shelf

Both models have a glass mirror surrounded by a 20 gauge stainless steel frame.



The #0625 has an 18 gauge stainless steel 5" wide shelf and is supplied with mounting brackets.

<u>Code</u>	<u>Size</u>
0620-1620*	16" W x 20" H
0620-1624*	16" W x 24" H
0625-1624*	16" W x 24" H w/ shelf

**Call for Price**

## MODESTY PANELS

### ADA MODESTY PANEL BRACKET



- Powder coated white
- Works with ADA plumbing panel
- Lift and pull to remove for easy access to plumbing
- 2mm adjustment side to side
- Uses 5mm Euro Screw
- Sold per set (4 individual members) - one set will mount one panel

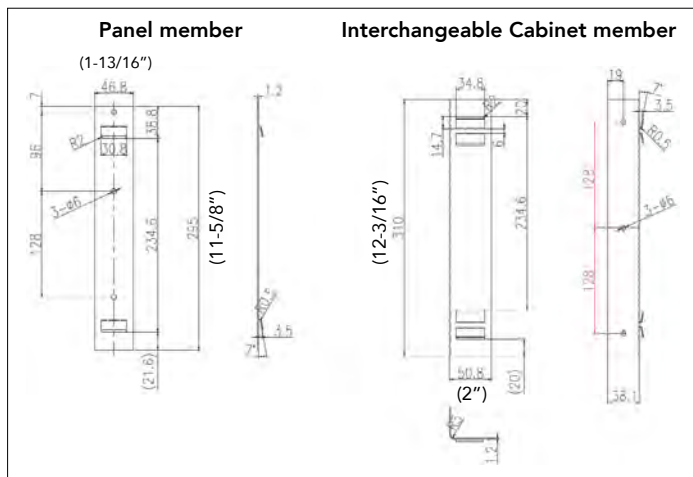
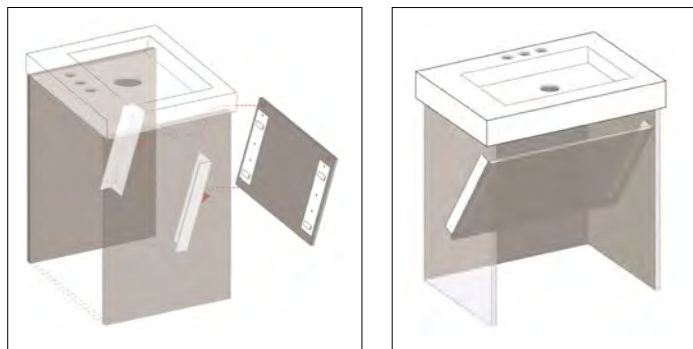
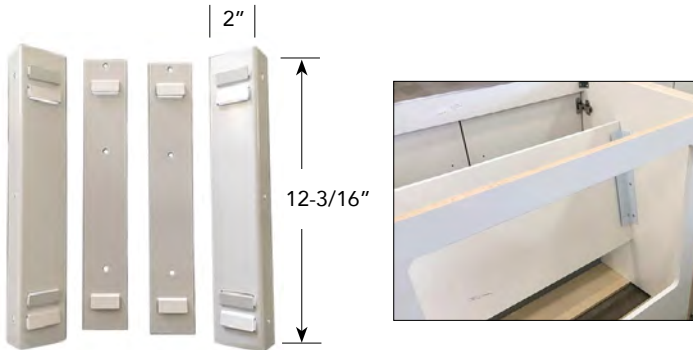

### Examples of installed Modesty Panels

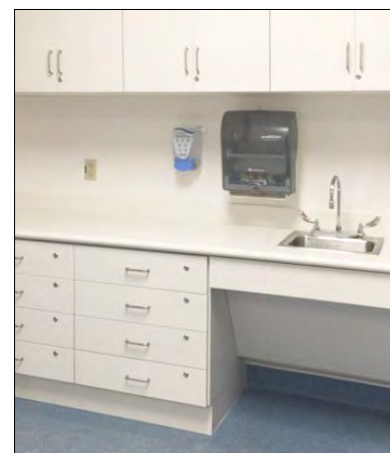

Sold per set. One set will mount one panel.

Code	Description	List/st
MPB-WH	Modesty Panel Bracket, Wht	\$ 23.25

12





## TOE KICKS

### TOE KICK FOR ADA SINK BASE DOORS

Prefabricated



Pre-manufactured recessed toe kick for ADA sink base doors. Made of durable, lightweight polystyrene. ADA compliant. 1/4" adjustment in all directions to reflect door gap distances, floor and floor covering conditions.

Trimable up to 6" each door side at hinge end. White finish, but can be laminated, painted, or covered with rubber or vinyl toe base. Available in 2" or 3" setback. Sold in sets of 1 right and 1 left hand toe kick. White trusshead screws included.

12

American Disability Act  
(ADA) compliant

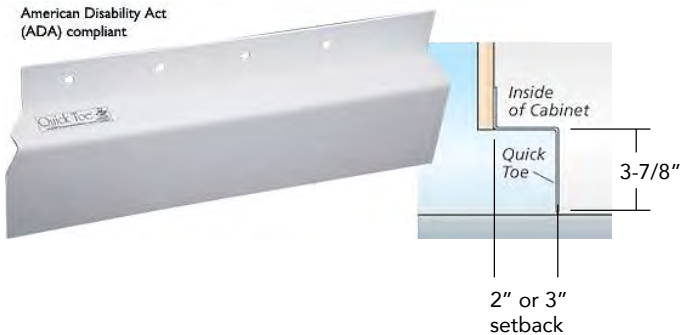

Code	Inside Cabinet	Trimable To Fit Openings	Setback	List/set
	Side-to-Side Total Width			
TK36-2	34-1/2"	36" down to 24"	2"	\$ 42.45
TK36-3	34-1/2"	36" down to 24"	3"	42.45
TK48-2	46-1/2"	46" down to 36"	2"	53.71
TK48-3	46-1/2"	46" down to 36"	3"	48.83

### ADA TOE KICKS

White Powder Coated Steel

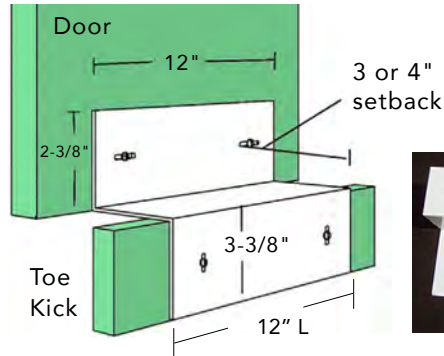

The setback is measured from the back of the door to the back of the toe kick.

This 18 gauge steel powder coated bracket allows the toe kick to swing out with the cabinet door allowing unimpeded access for wheel chairs to sink, counter, desk, or other work areas.

The toe kick allows for the same material as the cabinets creating a truly professional quality job without complicated joinery. This fully adjustable bracket provides a quick, strong, and inexpensive solution. Available in two offsets of 3" and 4" to allow for different toe kick depths.

Code	Description	List/pr
TK3-WH	ADA Toe Kick, 3" Setback	\$ 29.32
TK4-WH	ADA Toe Kick, 4" Setback	32.35



## CASTERS

### CASTERS WITH RUBBEREX WHEELS

A wheel with a soft rubber tread and a hard rubber core. For light duty application or where a cushioned effect is required & quiet movement is necessary. Unique King Pin Design, corrosion resistant, general purpose, deeply formed single raceway, hardened ball-bearing. 90-225 lbs.

Dimensions for Rubberex Swivel & Rigid Casters:

Wheel Size	Wheel Dia x Face	Load/Caster	Overall Height
2"	2" x 1"	90 lb	2-7/16"
2-1/2"	2-1/2" x 1-1/8"	100 lb	3-1/4"
3"	3" x 1-1/4"	175 lb	3-13/16"
4"	4" x 1-5/16"	225 lb	5"

### SWIVEL SERIES

Code	Size	Ctn	List/ea
CGD20RS	2"	24 ea.	\$ 6.36
CGD25RS	2-1/2"	18	8.72
CGD30RS	3"	12	12.51
CGD40RS	4"	6	16.98



### RIGID SERIES

Code	Size	Ctn	List/ea
CGD20RR	2"	24 ea.	\$ 6.13
CGD30RR	3"	18	10.61
CGD40RR	4"	12	15.72



#### TOP PLATE DIMENSIONS

Wheel Size	Swivel	Rigid
2"	1-7/8 x 2-9/16	1-1/2 x 2-21/32
2-1/2"	2-3/4 x 3-15/16	2-1/4 x 4-7/16
3"	3-1/8 x 4-1/8	2-1/2 x 4-15/16
4"	4 x 5-1/8	3-1/8 x 6-1/4

### SWIVEL SERIES w/Side Brake

Code	Size	List/ea
CGD20RSB	2"	\$ 5.94
CGD30RSB	3"	13.14
CGD40RSB	4"	22.03



Dimensions & Load Cap same as Swivel Series without side brake.

### SEMI-STEEL WHEEL CASTERS

High quality wheel with semi-steel castings. A good choice for heavy loads. Corrosion resistant, general purpose, deeply formed single raceway, hardened ball-bearings.



Pack: 4 each/ctn.

Code	Wheel Dia. x Face	Load/Caster	Overall Height	List/ea
CGD30SS	3" x 1-5/16"	250 lbs.	3-13/16"	\$ 16.13
108-4	4" x 1-1/2"	450 lbs.	5"	34.05

### PIANO CASTER

With Rubberex Wheels

Top plate: 2-3/4" x 4".  
Copper oxidized.



479-2

Pack: 4 each/ctn.

Code	Wheel Dia. x Face	Load/Caster	Overall Height	List/ea
479-2	2" x 7/8"	160 lbs.	2-13/16"	\$ 28.48



## CASTERS

### LIGHT/MEDIUM DUTY SWIVEL CASTERS



CLMA40P1RS

Aluminum hub, gray non-marking wheels, double raceway ball-bearing, yoke cups seal, annular ball-bearing wheel. 225-240 lb load capacity per each caster. Available with or without brakes.

Wheel Size	Wheel Dia. x Face	Plate Size	Overall Height	Swivel Radius
3-1/2"	3-1/2" x 1-1/4"	3-5/8" x 2-1/2"	4.75"	3-1/16"
4"	4" x 1-1/4"	3-5/8" x 2-1/2"	5.125"	3-5/16"

Code	Wheel	Load/Caster	List/ea
CLMA35P1RS	3.5"	225 lbs	\$ 40.61
CLMA40P1RS	4"	240 lbs	41.69

#### W/ Brake

CLMA35P1RSB	3.5"	225 lbs	41.65
CLMA40P1RSB	4"	240 lbs	46.85

### TWIN-WHEEL CASTERS

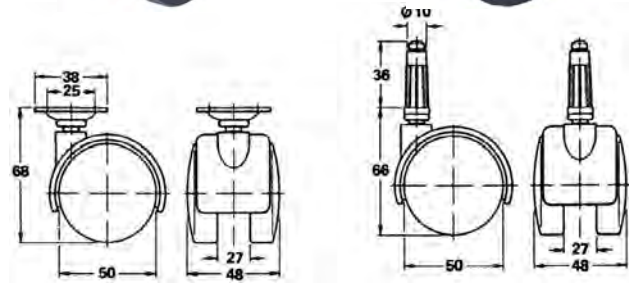

Choose from screw-on plate or knock-in socket attachments, with or without brake. Cover is made of polypropylene, and the wheels are made of nylon. Wheel diameter: 2". Load Capacity: 550 lbs/set of four. Carton Qty: 48 each.

Code	Caster	Finish	List/ea
1238	Socket Stem	Black Matte	\$ 1.95
1237	Plate	Black Matte	2.75

#### With Brake:

Code	Caster	Finish	List/ea
1236	Socket Stem	Black Matte	\$ 4.65
1235	Plate	Black Matte	4.72

### PLATE STYLE - SPHERICAL WHEEL



Metal-hooded rubber ball caster combines load capacity and style into one caster. Non-marking spherical wheel and double ball-bearing raceway caster provide easy movement of heavy loads. Use on sofas, chairs or heavy chests. Hardware finish is bright brass. Pack 10 per box.

Code	Wheel	O/A Ht.	Capacity	List/ea
CH15P2BR	1-1/2"	2-1/8"	90 lbs.	\$ 5.46
CH20P2BR	2"	2-1/2"	90	5.46

13

### METAL FURNITURE CASTERS

With Rubberex Wheels

Threaded Stem Caster:

Wheel dia. x Face: 2" x 7/8"

Overall height: 2-17/32"

Stem: 3/8-16 x 1-1/2"

Load Cap: 80 lbs. each



EY459

Rubberex Wheels have a soft rubber tread and a hard rubber core. Self-lubricating bearing wheel. Double ball-bearing raceways. Pack: 4 each.

Code	Wheel	Load/Caster	List/ea
EY459	2"	80 lbs	\$ 11.47



## DOLLIES

### GATE WHEEL - 4" Dia.

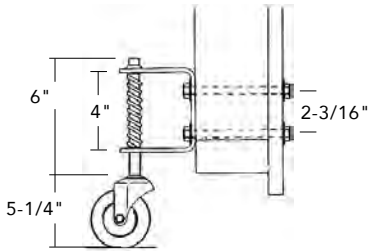

CGSL4  
4" Dia.

The Gate Wheel is ideal for uneven walkways. Helps support heavy gates. (Spring must be fully depressed to install.) Overall Ht: 11-1/4". Rubber wheel.

<u>Code</u>	<u>Load Cap</u>	<u>Wheel Dia.</u>	<u>List/ea</u>
CGSL4	240 lbs.	4"	\$ 54.35

### FURNITURE DOLLY



Thick carpeting protects furniture against scratching and marring. Extra wide 6" end rails give added support under heavy loads. Solid 1" kiln-dried hardwood frame. Shaped inside edge for easy handling. Plastic 3" wheels are non-marking. Load Capacity: 700 lbs. Frame Size: 18" L x 30" W.

<u>Code</u>	<u>Ctn</u>	<u>List/ea</u>
DL31830-MS	1 ea.	\$ 80.63

### HEAVY DUTY DOLLY



Heavy Duty Dolly, 19" x 32". Constructed with 4" casters, grey, non-marring tread and ball bearing axles.

1,000 lb capacity.

<u>Code</u>	<u>Ctn</u>	<u>List/ea</u>
HD1932-4	1 ea.	\$ 163.78

## CABINET LEVELERS

### CAMAR CABINET LEVELER

Black Plastic Leg & Black Plastic Foot  
 With 35mm Press Fit Socket



840-F2-00  
 Socket

35mm x 12mm hole required  
 for press fit portion of socket.  
 Socket outside diameter = 48mm.



448-10-P2  
 4" to 6-11/16"  
 height adjustment

Black plastic leg is adjustable from 4" to 6-11/16" in height. Load capacity: 650 lbs (per 4 levelers). Black plastic socket press-fits into 35mm x 12mm hole.

One Set = 1 ea. leg, 1 ea. foot, and 1 ea. socket:

Order (1) 448-10-P2 and (1) 840-F2-00 for complete set. Order toe kick separately.

Code	Description	Ctn	List
448-10-P2	Shaft, Insert & Foot	100 sts.	\$ 2.26
840-F2-00	Socket	100 ea.	1.29

### TOE KICK CLIP

Groove mount or Screw mount - works with all Camar levelers. Each Toe Kick includes a 4-Finger clip for attachment. Carton: 100/ea.



4 finger clip



202-AN-C2  
 Groove Mount



202-V1-T2  
 Screw Mount



Code	Description	List/ea
202-AN-C2	Groove Mount Toe Kick	\$ 1.10
202-V1-T2	Screw Mount Toe Kick	1.10

### PLASTIC LEG LEVELER SYSTEM

Load Capacity: 1500 lbs/set of 4

Heavy gauge plastic leg levelers, load cap. 375 lbs. per leg or 1500 lbs. per set of 4. Legs have a locating lug that allow you to adjust all legs to a 4-1/4" starting point. Legs can be adjusted from 3-7/8" to 6". Optional leg extender allows adjustment to 7-1/2". Black in color.

#5600-000  
**Leg Leveler Set**  
 Includes Top,  
 Tube and Bottom.



Leveler Top



Leveler  
 Tube

Leveler  
 Bottom

#5675-000  
**Leveler Extender**  
 Allows adjustment  
 to 7-1/2".



#5696-000  
**Screw-On  
 Toe Kick Clip.**  
 Snaps on to leg.

Code	Caster	Ctn	List
5600-000	Screw-On Leveler Set*	1 set/bg	\$ 4.64/st
5675-000	Leveler Extender	100	2.08/ea
5696-000	Screw-On Toe Kick Clip	100	2.56

\*One set consists of: 1 top, 1 tube & 1 bottom.

### BASE ELEVATING SCREW

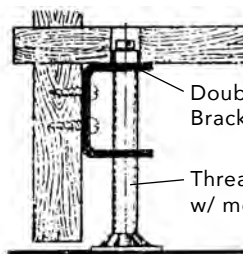

Double Angle  
 Bracket

Threaded Screw, galv. steel  
 w/ movable baseplate

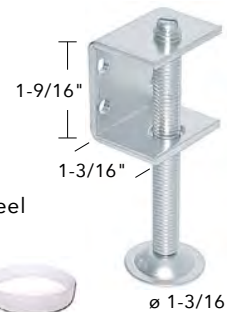

1-9/16"

1-3/16"

ø 1-3/16"

Pack: 100/ctn.

Protective Cap

Code	Description	List/ea
RL260GS	Double Angle Bracket w/ four fixing holes	\$ 1.58
RL2241070	Threaded screw, 2-3/4"	1.95
RL22410X90	Threaded screw, 3-9/16"	1.82
RL225	Protective Cap, polythene, 1/4" Ht, 1-5/16 Dia.	.18

## CABINET LEVELERS

### CAMAR CABINET LEVELERS



400-025

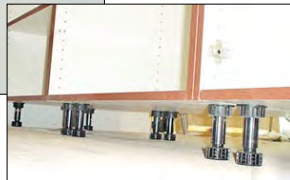

Camar levelers provide a load capacity of up to 850 lbs./385 kg per cabinet. Levelers screw on the bottom of the cabinet. They are adjustable from either the inside or the outside of the cabinet with a long shaft screwdriver. Allow for precision adjustment of cabinetry. Black ABS foot.

Pack: Each kit outfits one base cabinet.  
 Ctn: 10 kits per carton.

400-023B List \$ 31.44/bg  
 Contains 4 metal legs, plastic sockets, screw-mount toe kick clips, cover caps, with hollow screw and instructions.

400-024B List \$ 31.56/bg  
 Same as 400-023B but with groove-mounting toe kick clips.

400-025 List \$ 45.42/bg  
 Contains 4 metal legs, metal sockets, groove-mount toe kick clips, cover caps, with hollow screw and instructions.

400-026B List \$ 46.15/bg  
 Same as 400-025 but with screw-mounting toe kick clips.

400-027B List \$ 36.13/bg  
 Same as 400-025 except with wood screw mounting (instead of hollow screw).

## LEG LEVELERS

### CAMAR CABINET LEVELERS

Camar Three-piece levelers (foot, shaft and insert) available individually (from kits prev. column).

Provides a load capacity of up to 600 lbs. per leveler + socket. Required socket sold separately.



Code	Description	List/ea
345-10-02	Metal leveler, 4 - 6.5" adj.	\$ 6.29
345-17-02	Metal leveler, 6.5" - 9" adj.	7.61
835-E1-00	Metal socket, screw mount	2.91

### LEG ADJUSTER

Heavy Duty Leveling Leg Adjuster.

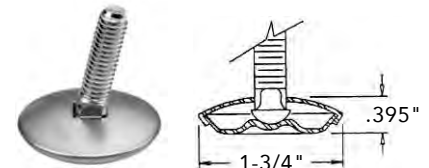

Thread: 3/8" - 16  
 Steel base, zinc plated.  
 Base: 1-3/4" O.D. 500 ea. per carton. May be used with T-Nuts or threaded bases.

Code	Bolt Length	Ctn	List/C
LA-175	1-1/2"	500 ea.	\$ 153.67
LA-175-2	2"	300	184.44

### T-NUTS



TNUT-14-20  
 1/4-20 thread  
 T38-16  
 3/8-16 thread



4-Prong Type

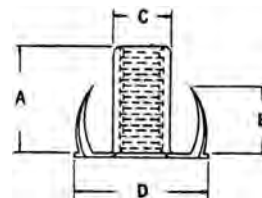

	A	B	C	D
T38-16	7/16	5/16	7/16	1
TNUT-14	13/32	1/4	5/16	11/16

### 4 Prong:

Code	Thread Size	List
T38-16	3/8-16	\$ 46.75 /C
TNUT-14-20	1/4-20	.35 /ea



## TACK GLIDES

### ADJUSTABLE GLIDES

Floor is protected by plastic base - white in color. Thread dia: 1/4-20. Thread length: 1". Cover shell chrome in color.



<u>Code</u>	<u>Ctn</u>	<u>List/ea</u>
FT53941	1000 ea.	\$ 1.95

A silent shock-absorbing adjustable glide for straight legs with the stud completely encased. Zinc plated stud is 1/4-20 x 1". Nickel plated solid shell is 1-1/4" outside diameter. Base is also nickel plated.



<u>Code</u>	<u>Ctn</u>	<u>List/ea</u>
7504-4-24	100 ea.	\$ 2.64

### 13 PLASTIC THREADED INSERTS



Threaded Insert



Shown with glide  
(Glide not included)

Rounded threaded insert for wood or die cast holes. Natural Nylon for 3/8" hole. (Glide not included.) For use with 1/4-20 threads.

<u>Code</u>	<u>Ctn</u>	<u>List/ea</u>
1313-49	100 ea.	\$ .40

### STANDARD NAIL GLIDE

White Nylon Glide

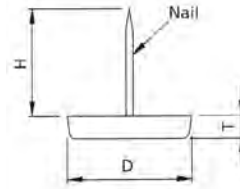

White Nylon

D = 5/8", 3/4", 7/8" dia.  
H = 3/4" nail length  
T = 6mm thickness of glide

<u>Code</u>	<u>Dia.</u>	<u>Ctn</u>	<u>List/M</u>
53813WH	5/8"	1000	\$ 53.87
53814WH	3/4"	1000	63.13
53815WH	7/8"	1000	47.39

### SINGLE PRONG GLIDE

Tough steel, nickel plated.  
5/8" Long shank.



<u>Code</u>	<u>Dia.</u>	<u>Ctn</u>	<u>List/C</u>
6112	1/2"	4000	\$ 5.42
6158	5/8"	4000	6.67
6134	3/4"	4000	12.06



## TABLE LEGS

### TABLE LEGS - CHROME

Peter Meier/Camar

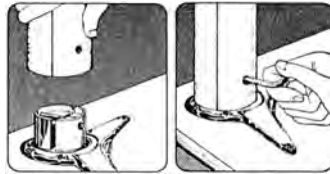

Built-in Height Adjustment

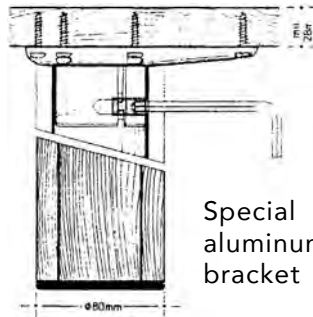

Special aluminum bracket

Height Adjustable: 1-1/8"  
Leg Width: 2-3/8"  
Min Table Thickness: 1.10"

Table legs with built-in height adjustment to eliminate shimming. Easily installed by screwing them to the underside of the table-top.

Load Capacity: 660 lb. per leg. Legs are 27-3/4" but are adjustable to a maximum of 28-7/8". Each set includes 4 legs, 1 ea. allen wrench, and 7 x 10-1" screws per leg. One set per carton. Other colors and sizes available special order.

Code	Description	Leg Dia.	List/set
330-70-CH	Chrome Table Legs, 4 ea/set.	2-3/4"	\$ 105.43

### INSET DOOR STOPS



251.79.600

Steel Inset Door Stop with polyurethane bumper. Various inset door applications. Use with Inset doors when self-closing concealed hinges are used. Nickel plated, 1-7/16" x 3/8". Use #6 pan head screw - sold separately.



251.79.604

Inset door stop for double doors when self-closing concealed hinges are used. Nickel plated, 15/16" x 1". Use #6 pan head screw - sold separately.

Code	Description	Pk	List/Pk
251.79.600	Door Stop w/ Bumper	48 ea	\$ 38.15
251.79.604	Double Door Bumper	48	75.00

## INSET DOOR STOPS

### INSET DOOR STOP

Tenn-Tex

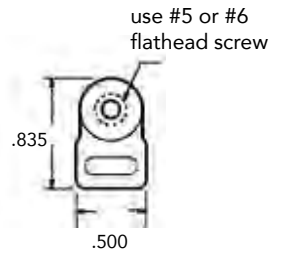

Door stop for cabinet inset doors. Clear in color. Uses #5 or #6 flathead screws (sold separately).

Code	Ctn	List/C
T230	1000 ea.	\$ 19.49

### INSET EURO DOOR STOP Fastcap "Cam" adjustable inset stop

ED-BR



Easy to Adjust



Screw Euro Door Stop at desired depth

ED-CL



Designed for use with inset cabinets. Simply screw inside cabinet and rotate to adjust where you want the cabinet door to shut.

Code	Color	Ctn	List/ea
ED-BR	Brown	100 ea.	\$ .27
ED-CL	Clear	100	.54

### DOOR STOP JIG

Fastcap

The Euro Door Jig is a compact tool used for accurate and repeatable placement of Euro Door Stops on cabinets. Door Stops sold separately (above).

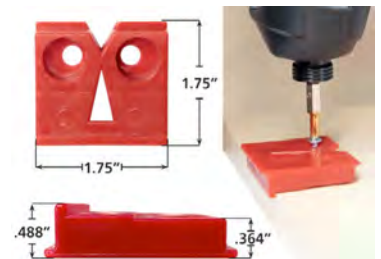

Code	Description	List/ea
ED-JIG	Euro Door Stop Jig	\$ 7.84



## BUMPERS & PADS

### CLEAR PLASTIC BUMPERS

Bumper Specialties

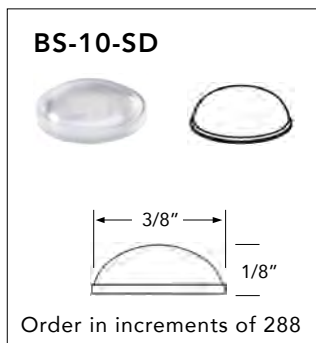
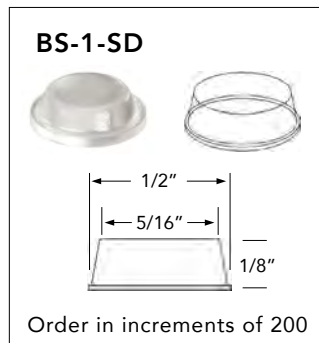

Must order per sheet.

Code	Ht.	Dia.	Sheet	List
BS-7	3/32"	5/16"	450 ea.	\$ 5.95/C
BS-12-SD	5/32"	3/8"	288	12.01
BS-1-SD	1/8"	1/2"	200	11.10
BS-10-SD	1/8"	3/8"	288	90.80/M

### BS-2 CLEAR PLASTIC BUMPERS

Bumper Specialties



BS-2

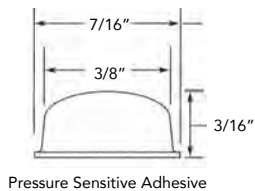

The BS-2 clear, plastic bumper is 7/16" in diameter and 3/16" high. The height of this bumper works well with Salice compact hinges.

There are 242 bumpers per pad and 5082 bumpers per Ctn. Must order in increments of 242.

Code	Ht.	Dia.	Sheet	Ctn	List/C
BS-2	3/16"	7/16"	242 ea.	21 sheets (5082 ea.)	\$ 10.49

### EXTRA SOFT BUMPER

Bumper Specialties

Made of 100% polyurethane resin. Extra soft yet extremely tough. Adhesive backed.



BS-58SD

Must order in increments of 200.

Code	Ht.	Dia.	Sheet	List/M
BS-58SD	3/16"	1/2"	200 ea.	\$ 79.98

### GRASS PLASTIC BUMPERS

Slightly Opaque



31002



31004

Must order in increments of 50 (1 sheet).  
 10 sheets per Ctn (500 ea.)

Code	Ht.	Dia.	Sheet	Ctn	List/M
31002	1/8"	7/16"	50 ea.	10 sheets	\$ 124.73
31004	1/16"	7/16"	50 ea.	10 sheets	108.01

### PRESS-IN BUMPERS



5mm x 2mm

This press-in plastic bumper is an easy way to protect most types of surfaces and prevent damage to furniture and equipment. 3/16" dia, 5/16" drilling depth. Clear finish.

Code	Description	List/M
MP-590	Press-In Bumper	\$ 267.86

### DECCO FELT HINGE PADS

Felt hinge pads, dia: 3/8".  
 5000 pads per roll, complete rolls only.



Code	Color	Thick	Roll	List/RI
PADS-5M-GR	Gray	1/16"	5000	\$ 67.62
PADS-5M-BL	Black	3/32"	5000	67.62



## STANDARDS & BRACKETS

### **KV 80 SLOTTED STANDARD**

Steel

1" Adjustment,  
Width: 5/8", Height: 13/32"

All sizes 10/box.



Use with the KV 180 Brackets shown in the next column. Pack: 10 each/box.

### **Anochrome**

<u>Code</u>	<u>Size</u>	<u>List/ea</u>
80A-24	24"	\$ 4.86
80A-36	36"	8.96
80A-48	48"	10.47
80A-60	60"	12.71
80A-72	72"	21.05
80A-84	84"	20.79
80A-96	96"	19.72

### **White**

<u>Code</u>	<u>Size</u>	<u>List/ea</u>
80WH-48	48"	\$ 12.08
80WH-60	60"	13.06
80WH-72	72"	19.02

### **KV 180 BRACKETS**

Steel



1" Adjustment  
Use with KV 80 standards

Pack: 10 each/box.

### **Anochrome**

<u>Code</u>	<u>Size</u>	<u>List/ea</u>
180A-6	6"	\$ 4.03
180A-8	8"	4.13
180A-10	10"	4.51
180A-12	12"	7.45
180A-14	14"	8.88
180A-16	16"	8.04
180A-18	18"	10.21
180A-20	20"	11.96

### **White**

<u>Code</u>	<u>Size</u>	<u>List/ea</u>
180WH-6	6"	\$ 5.03
180WH-10	10"	4.78
180WH-12	12"	5.10
180WH-14	14"	7.20
180WH-16	16"	6.97
180WH-18	18"	10.00





## KV BRACKETS

### KV 183 HEAVY DUTY FLANGED BRACKET

Steel, Anochrome finish



Right, Left, Center  
Heavy Duty  
#183 angle Slot bracket  
(1" increments)

Rights/Lefts priced the same. Pack: 10 each.

Left	Right	List	Center	List
183A-L-8	183A-R-8	\$ 9.74	183A-C-8	\$ 15.22
183A-L-10	183A-R-10	10.70	183A-C-10	15.96
183A-L-12	183A-R-12	11.84	183A-C-12	17.23
183A-L-14	183A-R-14	13.52	183A-C-14	18.93
183A-L-16	183A-R-16	15.36	183A-C-16	20.92
183A-L-18	183A-R-18	17.09	183A-C-18	23.22
183A-L-20	183A-R-20	18.81	183A-C-20	25.24

### KV 185 HEAVY DUTY DOUBLE BRACKET

Steel, Anochrome finish



Heavy Duty #185  
Double Slot bracket  
(1" increments)

Pack: 10 each

Code	List/ea	Code	List/ea
185A-12	\$ 14.51	185A-20	\$ 23.02
185A-14	16.11	185A-22	29.19
185A-16	17.35	185A-24	30.29
185A-18	18.02		

### KV 160 LOCK LEVER BRACKETS

Steel, Anochrome finish, 1" Increments



#160 Lock Lever bracket

Features stabilizing lock-lever. Ideal for high traffic displays. Other sizes available Special Order.

Code	Size	Ctn	List/ea
160A-12	12"	10 ea.	\$ 7.77

### KV 186 & KV 187 HEAVY DUTY BRACKETS

Steel, Anochrome finish, 2" Increments



#186 Slot bracket  
Extra Heavy Duty



#187 Slot bracket  
Extra Heavy Duty

Pack: 5 each

Code	List/ea	Code	List/ea
186A-8	\$ 11.90	187A-16	\$ 17.03
186A-10	12.54	187A-18	18.50
187A-12	15.03	187A-22	25.86
187A-14	15.11	187A-24	27.57

### RESTS FOR #186/#187 BRACKETS Anochrome



Center  
Rest  
#211



Front  
Rest  
#212KV

Code	Description	Ctn	List/ea
211	Center Rest	100	\$ 1.62
212KV	Front Rest	100	1.66

### RUBBER CUSHION

for #103, #104, #105, #210 & #211, #212 rests



#129  
Cushion

Code	Description	Ctn	List/ea
129	Cushion	100	\$ .47

### KV 179 ADJUSTABLE SLANT BRACKETS

Steel, Anochrome finish, 1" Increments



#179 Adjustable bracket

Adjustable to 15°, 30°, 45° and 90°.

Code	Size	Ctn	List/ea
179A-12	12"	10	\$ 18.25
179A-14	14"	10	19.09



## SHELF STANDARDS

### **KV 71 - NARROW STANDARD - Special Order**

Steel, Anochrome finish, 1" Increments

Code	Size	Ctn	List/ea
71A-4*	48"	10 ea.	\$ 32.19
71A-5*	60"	10	39.08
71A-6*	72"	10	54.51
71A-8*	96"	10	64.98

### **KV 83 - HEAVY DUTY OVERSIZED STANDARD**

Steel, Anochrome finish, 1" Increments

Code	Size	Ctn	List/ea
83A-2	24"	10 ea.	\$ 8.54
83A-3	36"	10	11.18
83A-4	48"	10	14.92
83A-5	60"	10	18.70
83A-6	72"	10	22.24
83A-7	84"	10	26.16
83A-8	96"	10	28.11

### **KV 85 - DBL SLOTTED HEAVY DUTY STANDARD**

Steel, Anochrome finish, 1" Increments

Code	Size	Ctn	List/ea
85A-3	36"	10 ea.	\$ 11.90
85A-4	48"	10	15.76
85A-5	60"	10	19.45
85A-6	72"	10	23.63
85A-7	84"	10	27.23
85A-8	96"	10	32.67

### **KV 87 - EXTRA HEAVY DUTY STANDARD**

Steel, Anochrome finish, 2" Increments

Pack: 5 each.

Code	Size	List/ea	Code	Size	List/ea
87A-2	24"	\$ 15.93	87A-6	72"	\$ 43.80
87A-3	36"	22.31	87A-7	84"	58.78
87A-4	48"	31.80	87A-8	96"	56.96
87A-5	60"	36.46			



<b>#71 Slotted Narrow</b> 5/16" Width 13/32" Deep	<b>#83 Slotted Heavy Duty Oversized</b> 3/4" Width 1/2" Deep	<b>#85 Double Slotted Heavy Duty</b> 1-1/4" Width 1/2" Deep	<b>#87 Slotted Extra Heavy Duty</b> 7/8" Width 11/16" Deep
---	--	---	--

#71, 83, 85 are 1" increments, #87 are 2" increments

		STANDARDS																				
		51	56	70	71	80	81	82	83	85	87	90	91	92	96	97	98	144	146	148	233	255
BRACKETS	52	X																				
	57		X																			
	159		X	X	X	X	X	X	X	X	X	X	X	X	X	X	X	X	X	X	X	X
	160		X	X	X	X	X	X	X	X	X	X	X	X	X	X	X	X	X	X	X	X
	161		X	X	X	X	X	X	X	X	X	X	X	X	X	X	X	X	X	X	X	X
	170		X	X	X	X	X	X	X	X	X	X	X	X	X	X	X	X	X	X	X	X
	171					X	X	X	X	X	X	X	X	X	X	X	X	X	X	X	X	X
	173					X	X	X	X	X	X	X	X	X	X	X	X	X	X	X	X	X
	175					X	X	X	X	X	X	X	X	X	X	X	X	X	X	X	X	X
	177		X	X		X	X	X	X	X	X	X	X	X	X	X	X	X	X	X	X	X
	179					X	X	X	X	X	X	X	X	X	X	X	X	X	X	X	X	X
	180					X	X	X	X	X	X	X	X	X	X	X	X	X	X	X	X	X
	182							X														
	183						X	X	X	X	X	X	X	X	X	X	X	X	X	X	X	X
	184							X														
	185									X												
	186										X											
	187											X										
	194					X	X	X	X	X	X	X	X	X	X	X	X	X	X	X	X	X
	195					X	X	X	X	X	X	X	X	X	X	X	X	X	X	X	X	X
196										X												
197										X												
204																						
205																						
206																						
228																					X	
229																					X	

### **Standards & Bracket Selection Chart**

This chart lists all of the many standards and brackets manufactured by Knappe & Vogt. It will enable you to determine which bracket to use with each standard.



## SHELF STANDARDS

### KV STANDARDS 233 Surface Mount



All Special Order

Steel, Surface Mounted,  
1/2" increments.

13/16" Width x 3/16" Deep.

Use Shelf Supports on  
following page.

Code	Description	Ctn	List/ea
233ZC-24*	Zinc (Steel), 24"	100	\$ 1.68
233ZC-36*	" " 36"	100	2.64
233ZC-48*	" " 48"	100	3.66
233ZC-60*	" " 60"	100	4.47
233ZC-72*	" " 72"	50	5.31
233ZC-96*	" " 96"	50	7.11

### KV STANDARDS 255 Flush or Surface Mount

Flush or Surface Mounted,  
1/2" increments.

5/8 Width x 3/16" Deep.

Use Shelf Supports on  
following page.



#### Steel, Zinc Finish

Code	Description	Ctn	List/ea
255ZC-24	Zinc, 24"	100	\$ 2.14
255ZC-30	" 30"	100	2.58
255ZC-36	" 36"	100	3.30
255ZC-48	" 48"	100	4.18
255ZC-60	" 60"	100	4.82
255ZC-72	" 72"	50	5.84
255ZC-84	" 84"	50	7.51
255ZC-96	" 96"	50	8.24

(cont. next column)

### KV STANDARDS 255 continued

#### Steel, Brass Finish



255BR-36	Brass, 36"	100	\$ 3.59
255BR-48	" 48"	100	5.46
255BR-72	" 72"	50	8.06
255BR-96	" 96"	50	10.09

#### Steel, White Finish



255WH-18	White, 18"	100	\$ 2.34
255WH-24	" 24"	100	2.49
255WH-36	" 36"	100	3.59
255WH-48	" 48"	100	4.90
255WH-60	" 60"	100	6.00
255WH-72	" 72"	50	7.24
255WH-84	" 84"	50	8.56
255WH-96	" 96"	50	9.73

#### Aluminum, Natural Aluminum Finish



255AL-24	Alum, 24"	100	\$ 2.78
255AL-30	" 30"	100	3.13
255AL-36	" 36"	100	3.43
255AL-48	" 48"	100	4.49
255AL-60	" 60"	100	6.03
255AL-72	" 72"	50	6.48
255AL-84	" 84"	50	8.15
255AL-96	" 96"	50	8.57

#### Aluminum, Walnut Finish\*\*



255ALWAL-72	" 72"	50	\$ 8.27
255ALWAL-84	" 84"	50	11.27

\*\*disc when out



## SHELF SUPPORTS

### NAILS FOR KV 255 STANDARDS

Pack: 650/bag. No broken bags.



Code	Finish	Pack	List/bg
255-81 BR	Brass	650/bg	\$ 12.04
255-81 WH	White	650	16.42
255-81 ZC	Zinc	650	15.12

### KV 256 SHELF SUPPORTS

Use with KV 233 and 255 Standards

Pack: 100/Ctn.  
Full Cartons Only.



#256 Support  
(1/2" increments)

Code	Finish	Ctn	List/ea
256ZC	Zinc (Steel)	100	\$ .41
256BR	Brass (Steel)	100	.45
256WH	White (Steel)	100	.88
256ALM	Almond (Steel)	100	.71
256WAL	Walnut (Steel)	100	.48
256ALNAT	Natural Aluminum	100	.44

### KV 256 BULK PACK

Pack: 1000/Ctn.  
Full Cartons Only.



Code	Finish	Ctn	List/ea
256B-ZC	Zinc (Steel)	1000	\$ .39

### KV 256 IN POLYBAGS

12 each per bag,  
10 bags per box.



Code	Finish	Ctn	List/bg
256P-WH	White	10	\$ 11.41

### KV 237 STEEL SHELF SUPPORTS

Use with KV 233 Standards

Zinc Finish.



#237 Support  
(1/2" increments)

Code	Ctn	List/ea
237ZC	100	\$ .68

### KV 238 SHELF SUPPORTS w/ Locator Tab

Use with KV 233 Standards

Anochrome Finish.



#238 Support  
(1/2" increments)

Code	Ctn	List/ea
238	100	\$ .81

### KV 239 STEEL SHELF SUPPORTS

Use with KV 233 and 255 Standards

Zinc Finish.



#239 Support  
(1/2" increments)

Code	Ctn	List/ea
239ZC	100	\$ .54

### KV 243 SHELF SUPPORTS

Use with KV 233 and 255 Standards

Zinc Finish.  
With 3" Cross Support



#243 Support  
(1/2" increments)

Code	Ctn	List/ea
243ZC	100	\$ 3.48



## SHELF SUPPORTS

### STEEL SHELF SUPPORTS

- KV 345: 5mm Pin
- KV 346: 1/4" Pin
- KV 348: 5mm Pin (w/ vinyl cover)
- 2607: 1/4" Pin
- 2707: 5mm Pin



Code	Finish	Pin	Ctn	List
346NP	Anochrome	1/4"	100	\$ .53 /ea
346BR	Brass	1/4"	100	.51
346WAL	Walnut	1/4"	100	.49
348ALM	Almond	5mm	100	.58
348BROWN	Brown	5mm	100	.58
2607BN	Nickel	1/4"	1000	\$ 25.48 /C
2607PB	Brass	1/4"	1000	21.96
2707BN	Nickel	5mm	1000	50.29
2707PB	Brass	5mm	1000	28.21
2707AC	Ant. Copper	5mm	1000	50.36

### SHELF SUPPORT

With 5mm (3/16") steel pivot pin. Plastic coated.

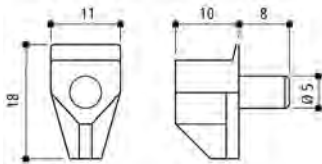

Clear



White

Code	Color	Ctn	List
HD161.549.30	Clear	1000	\$ 8.34 /C
SC5MM-CL	Clear	100/bg	10.20 /bg
SS23-WH	White	5000	88.66 /M

### SWEDISH TYPE SHELF SUPPORT

Insert into pre-drilled holes; the shelves are then simply put on the supports, or kerfed to slip over supports.  
Dia: 3mm. Length: 8.82".  
Galvanized steel wire. 100 per box.



282.71.712 List \$ 51.05/C

### PLUG-IN SPOON-SHAPED SHELF SUPPORTS

Steel Stud in 5mm or 1/4" Pins



Nickel



Black



Brass



Antique Copper

Pack: 100 each.

Code	Finish	Pin	List/C
SC5MM-PB	Brass	5mm	\$ 12.02
SC5MM-NI	Nickel	5mm	10.79
1306BK	Black	5mm	19.75
2306AC	Ant. Copper	5mm	12.28
SC14-PB	Brass	1/4"	10.40
SC14-NI	Nickel	1/4"	10.98

### KV 333 SUPPORT



Steel, Bright Zinc Plate.

Pin Dia: 7/32"; use 15/64" diameter drill.  
Pin Length: 1/2", Shelf Rest - 9/16" W x 7/16" L

Code	Ctn	List/ea
333KV	1000	\$ .60

### PLUG-IN SHELF SUPPORTS



Brown



White

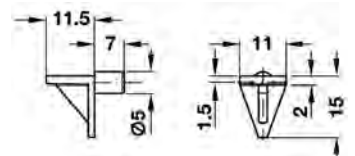

Plastic shelf support with a grooved 5mm stud.  
(sizes are in mm).

Code	Finish	Ctn	List/C
283.63.117	Brown	500 ea.	\$ 5.23
283.63.715	White	500	6.61



## SHELF SUPPORTS

### BAINBRIDGE PLASTIC SHELF CLIPS



Tan  
Fluted



White  
Smooth

Pin Dia: 1/4" or 5mm  
Pin Length: 11/32"  
Smooth or Fluted Stem  
Ctn. Qty: 10,000 each

### 1811 - 1/4" Diameter Pins

Code	Color	Stem	List/M
1811FL	Tan	Fluted	\$ 100.78
1811FC-50	Clear	Fluted	97.30
1811WH	White	Smooth	124.48
1811-	Tan	Smooth	93.06

### 3811 - 5mm Diameter Pins

Code	Color	Stem	List/M
3811T-50	Tan	Smooth	\$ 75.75
3811C-50	Clear	Smooth	78.48
3811W-50	White	Smooth	100.67

### HETTICH SHELF SECURING STUD

With pivot for 5mm (3/16") holes. Made of translucent plastic.

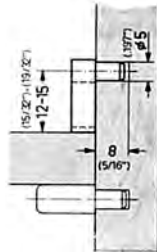

Code	Ctn	List/C
1005082	1000	\$ 8.75

### EARTHQUAKE CLIPS



Load Rating: 80 lbs. Pin Diameter: 5mm,  
Pin Length: 8mm. Overall: 2-1/4" L x 3/4" W  
Pack: 2500 each

Code	Shelf	Color	List
50536*	5/8"	Clear	\$ 14.51/C
50531*	5/8"	White	83.13/M
50636*	3/4"	Clear	147.61

\*disc when out

## EARTHQUAKE CLIPS

### EARTHQUAKE CLIP

Tenn-Tex

#T-803 -- Clear

Load Rating: 300 lbs.  
Double pins are 5mm dia  
x 10mm L  
C to C = 32mm  
Overall: 2-1/2" L x 1-1/8" W



T-803

For 3/4" or 1" shelves.  
Shelf cut size: Inside cab width  
minus 6mm.

Code	Ctn	List/ea
T-803	1000 ea.	\$ .60

### EARTHQUAKE-PROOF SHELF SUPPORT

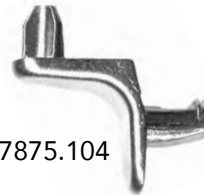

02.7875.104

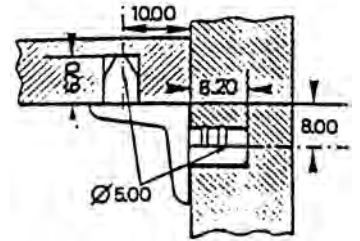

The two 5mm posts on nickel plated Zamac shelf support keep shelves from sliding in the event of an earthquake.

Code	Ctn	List/C
02.7875.104	100 ea.	\$ 24.43



02.7879.104

Non-Seismic  
Version

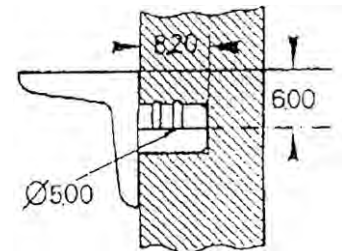

Nickel plated with one 5mm peg.

Code	Ctn	List/C
02.7879.104	100 ea.	\$ 23.51



## SHELF SUPPORTS

### REV-A-SHELF LOCKING SHELF CLIP



Height: 2-1/4"  
 Depth: 5/16"

Available for 3/4" (305-34)  
 and 5/8" (305-58) shelves.

5mm pins.

Polymer locking shelf clip with 5mm pin.  
 Bulk pack: 1000, Sold per 100 each.

Code	Size	Finish	List/C
305-34-0010-1	3/4"	White	\$ 17.34
305-34-0020-1	3/4"	Clear	17.34
305-58-0010-1	5/8"	White	17.34
305-58-0020-1	5/8"	Clear	17.34

### LOCKING SHELF SUPPORTS

Locking shelf support with  
 2 each 5mm pins.  
 White in color.



3227W - 3/4"  
 3228W - 1"

Pack: 2500/Ctn.

Code	Shelf	C/C of stems	List/C
3227W-50	3/4"	1-1/4"	\$ 66.57
3228W-50	1"	1-1/4"	53.67

Locking shelf support in  
 5mm or 1/4" dia. pins.  
 White in color.



3226W - 5mm  
 3236W - 1/4"

Pack: 1000/Ctn.

Code	Shelf	Pin	List/M
3226W-30	3/4"	5mm	\$ 101.89
3236W-30*	3/4"	1/4"	91.30

\*disc when out

### SHELF SUPPORTS FOR GLASS SHELVES

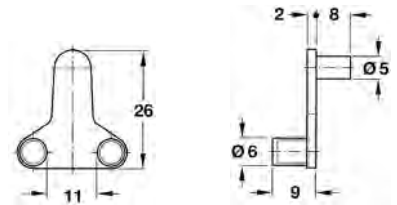

282.23.716

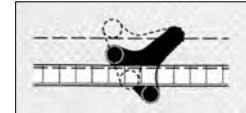

These shelf clamp supports are for glass shelves from 6-10mm thick. Mount glass on top of or between the two projecting supports. Clamping pins have a plastic coating. Shelf pin fits a 5mm hole. Zinc die-cast, nickel plated.

Code	Description	Ctn	List/ea
282.23.716	Glass Shelf Support	10 ea.	\$ 1.82

### GLASS SHELF PIN

Glass Shelf Pin, 3/16" hole (5mm).  
 Overall length: 17mm.



MP-GC  
 5mm

Code	Ctn	List/M
MP-GC	1000	\$ 93.88

### SHELF PINS



#FT58370

Duplo Pin  
 5mm x 16mm

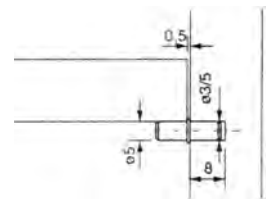

#FT58341

Straight Pin  
 5mm x 25mm

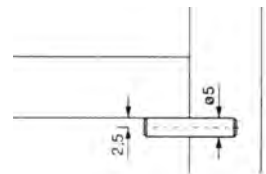

Code	Description	Ctn	List
FT58370	Duplo Pin, Zinc	100 ea.	\$ 29.17/ M
FT58341	Straight Pin, Nickel	100	8.38/ C

## SUPPORT BRACKETS

### GRANITE COUNTER SUPPORTS

Rockford Process Control

Granite Counter Support Brackets support the overhang on Granite top Islands and bars without corbels or other visible support.



A pair of brackets support up to 300 lbs. when mounted correctly. Heavy Duty brackets will support up to 500 lbs. Drilled for countersunk screws up to #14 flat head. Material: Plate Steel, Black finish. 3.5" Widths and 12", 16", 24" and 30" lengths.

GCS-12 thru 24, GCS-12-HD thru 24-HD

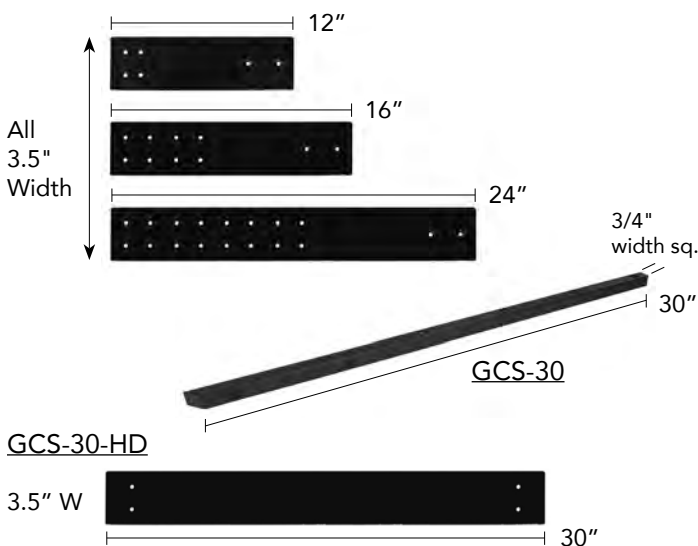

#### Installation

Attach support studs to the top of cabinets at the back panel and where the end of the support bracket falls. Rout a dado so bracket is flush with bottom of countertop and top of stud. Attach bracket to studs using min of four screws with a 1.5" min length. A min of 1/3 of the bracket must be mounted inside the cabinet. The countertop must rest on the Support Bracket. Brackets should be mounted every 16". Overhang beyond the Bracket should not exceed 6". Check with the counter manufacturer for their overhang recommendations. Apply adhesive to both the counter top and the Support Bracket when mounting the counter top.

Code	Description	Thk	List/ea
GCS-12	Counter support, 12"	3/16"	\$ 15.41
GCS-16	Counter support, 16"	3/16"	20.15
GCS-24	Counter support, 24"	3/16"	30.05
GCS-30	Counter support, 30"	3/4"	25.03
GCS-12-HD	HD Counter support, 12"	1/4"	\$ 17.61
GCS-16-HD	HD Counter support, 16"	3/8"	33.87
GCS-24-HD	HD Counter support, 24"	3/8"	49.99
GCS-30-HD	HD Counter support, 30"	3/8"	59.44

### SPEEDBRACE T-BRACE

FastCap



Fastcap T-Brace is the perfect way to create the illusion of a free floating shelf that is strong enough to support over 300 lbs. per pair. Ideal for new construction, but can be used in a remodeling application when an access hole is cut in the drywall for attachment.

Black finish, 5" x 3/4" thick. Available in 11" and 16" lengths.

#### Features

- 1/4" to 3/8" steel
- Mounting holes on both sides
- 300 lb. capacity per pair

#### Great For

- Floating shelf
- Floating mantels

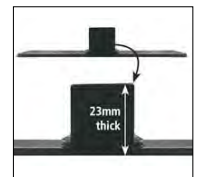
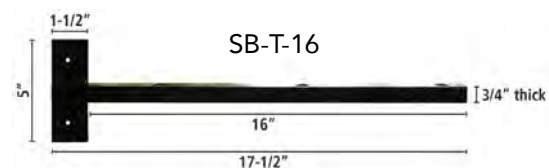

Use vix or hinge bit to center holes

Pack: 10 each.

Code	Description	List/ea
SB-T-11	T-Brace, 11" Black SpeedBrace	\$ 51.48
SB-T-16	T-Brace, 16" Black SpeedBrace	64.35

## SUPPORT BRACKETS

### SPEEDBRACE "STEALTH" FastCap



Nearly invisible when installed



12" & 16" mounted on pony wall

24" mounted on double bracing

The Stealth Speedbrace supports your countertop and bar overhangs with no visible kicker or expensive corbels. A pair of braces will support 300 lbs. of weight. Sold individually.

#### Features

- 3/16" Steel, 3-1/2" wide
- Black Finish
- Countersunk screwholes

#### Great For:

- Countertops
- Bars
- Extra Bracing

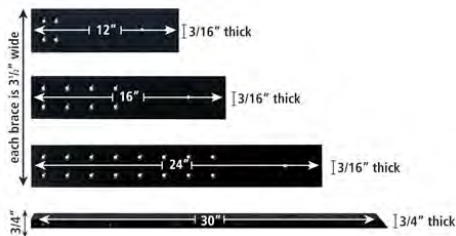

### 14 30" size fastens to Inside Cabinets



30" Length x 3/4" Thick

Code	Description	List/ea
SB-12BL	12" Black Speedbrace	\$ 23.87
SB-16BL	16" Black Speedbrace	31.82
SB-24BL	24" Black Speedbrace	40.91
SB-30BL	30" Black Speedbrace	44.05



### SPEEDBRACE "STEALTH" HD Heavy Duty

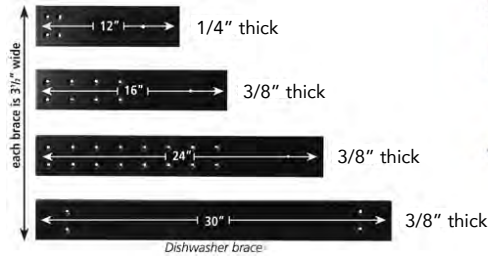

Heavy duty version of the "Stealth" Speedbrace. A pair of HD braces will support 500 lbs. of weight. 12" is 1/4" thick. 16", 24" and 30" are 3/8" thick. All 3-1/2" wide. Black finish. Sold individually.

Code	Description	List/ea
SB-12HD	12" Heavy Duty Speedbrace	\$ 28.31
SB-16HD	16" Heavy Duty Speedbrace	44.52
SB-24HD	24" Heavy Duty Speedbrace	62.77
SB-30HD	30" Heavy Duty Speedbrace	89.46

### SPEEDBRACE ISLAND Heavy Duty

The Stealth Island SpeedBrace supports your island countertops and bar overhangs with no visible kicker or expensive corbels. A pair of Island SpeedBraces will support 500 lbs. of weight. 3/8" thick steel, black finish. Sold individually.



Easy to install

#### Great For:

- Island Countertops
- Bars
- Extra Bracing

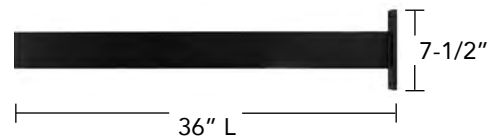

Code	Description	List/ea
SB-36BL	36" Black SpeedBrace Island	\$ 141.56

## SUPPORT BRACKETS

### HYBRID BRACKETS

Surface or Concealed Mounting

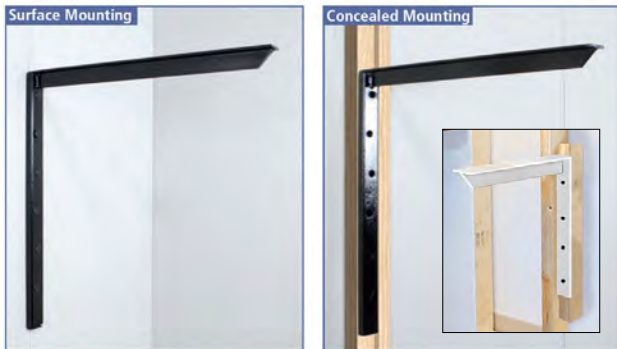

#### Features

- Surface mount or concealed mounting for floating shelf appearance
- Mounts with screws (faster)
- Black or White powder coated finish
- Non-handed
- Plastic finishing caps included for surface mounting
- **Allows room for plumbing/electric**

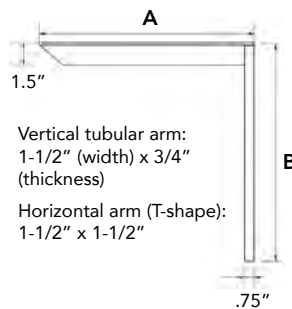

#### Surface mount



Plastic finishing caps that conceal the bottom of tube (2) and the screw holes (1) are included.

#### Concealed mount



Concealed applications require ripping a 2" x 4" lengthwise, and mounting it (2) to the side of a standard 2" x 4" stud (1).

### Hybrid Brackets / 2 per Carton, sold per each.

Code	(A) Support Arm	(B) Height	Load Cap (pair)	List
HYB-12BL	12"	12"	2050 lbs.	\$ 56.88
HYB-12WH	12"	12"	2050	47.40
HYB-18BL	18"	18"	1780	71.28
HYB-18WH	18"	18"	1780	71.28
HYB-24BL	24"	24"	1360	85.83
HYB-24WH	24"	24"	1360	86.62

Order screws separately.

### CONCEALED WORK STATION BRACKETS

Mount to stud for extra strength

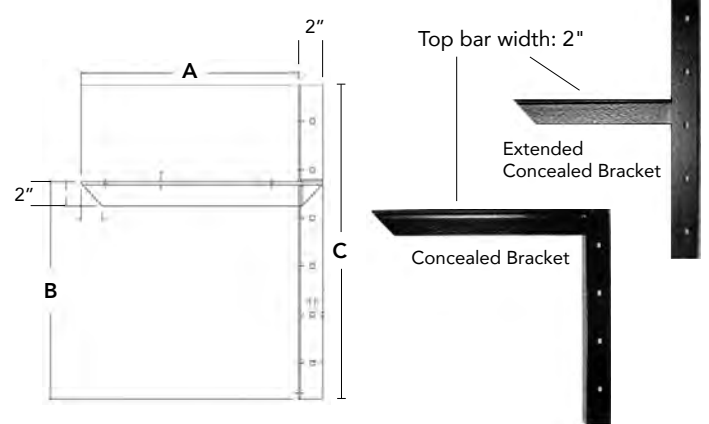

- Steel Construction
- Load limit range of 1,800 to 4,500 lbs. per pair
- Mounting hardware included
- All welds on reverse for easy, clean install
- Black in Color



This Island was made using Extended Concealed and Concealed brackets



Extended Concealed brackets used to create a floating shelf

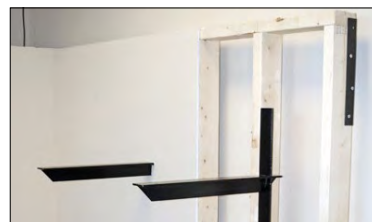

This picture shows the installation of the Extended Concealed Bracket behind drywall and how it looks when the drywall is installed overtop

Code	A	B	C	Weight Cap / pr.	List/ea
C18-BL	18"	18"	-	2,060	\$ 75.83
C24-BL	24"	18"	-	1,800	88.42
EC-18BL	18"	18"	26"	4,500	83.91
EC-24BL	24"	18"	26"	2,320	88.33

## SUPPORT BRACKETS

### WORK STATION SUPPORT BRACKETS

For Countertops, Desktops and Table Supports



- 1000 lb Load
- 11 Gauge Steel (1/8" thick)
- Weight Limit Exceeds 1000 lbs/pr.
- 1-1/2" Forms with 1/4" Holes
- Two Colors, Five Sizes



Code	Size	Color	Ctn	List/pr
812BL	8" x 12"	Black	5 pr.	\$ 28.97
812WH	8" x 12"	White	5	33.05
1218BL	12" x 18"	Black	3	78.13
1218WH	12" x 18"	White	3	57.63
1521BL	15" x 21"	Black	3	65.72
1521WH	15" x 21"	White	3	53.61
1824BL	18" x 24"	Black	3	89.98
1824WH	18" x 24"	White	3	89.98
2429BL	24" x 29"	Black	2	89.80
2429WH	24" x 29"	White	2	89.80

### PHILLIPS PAN HEAD TYPE 17 SCREWS

Quickscrews

# 12-8 X 3/4" Phillips Pan Head Coarse Thread Type 17 Zinc Plated Screws.

Can be used with Heavy Duty Workstation Support Brackets and the Heavy Duty Speed-brace Stealth Brackets.



Code	Description	Ctn	List/C
9807	# 12-8 X 3/4" Phillips Pan Head	100	\$ 6.47

### KV 206 FOLDING L-BRACKET

Heavy Duty

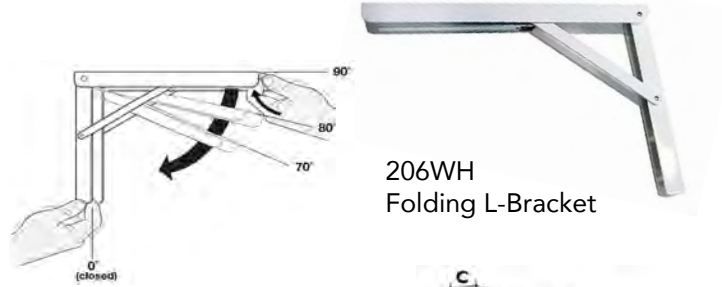

206WH  
 Folding L-Bracket

#### Dimensions:

Size	A	B	C
12"	11.8"	7.9"	.6"
16"	15.75"	10.6"	.8"

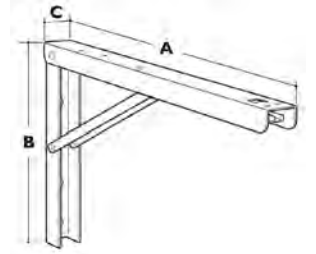

- For 12" to 24" Deep shelving
- Can be mounted to any type of wall
- Adjustable to 4 positons: 90°, 80°, 70°, and 0° (closed position)
- Durable zinc-coated steel construction with spring-loaded release lever
- Exceeds BHMA static load testing requirements
- Load Rating: 12" - Up to 770 lbs/pr  
 16" - Up to 880 lbs/pr

These sturdy folding L-brackets allow you to create a worksurface that can be quickly folded out of the way when no longer needed. The KV 206 bracket's convenient one-hand release mechanism makes the bracket easy-to-open, close, or adjust without the danger of getting hands caught in a folding crossbar.

Code	Description	Ctn	List/ea
206WH12	12" White Folding Brkt	10	\$ 35.44
206WH16	16" White Folding Brkt	10	98.01



**SHELF BRACKETS**

**KV HEAVY DUTY SHELF BRACKET**



Holds up to 1000 lbs. per pair when mounted per manufacturer recommendations. 5mm thick steel bar construction. White epoxy coated finish. Recommended fasteners (not included) are 3" or longer x 5/16" lag screws mounted into studs. Attach shelf using a #8 or larger round-head wood screw.

Code	Height x Length	Ctn	List/ea
208WH300	8.3 x 11.6"	10 ea.	\$ 12.53
208WH400	10.6 x 16.6"	10	14.88
208WH500	12.9 x 19.5"	10	16.90
208WH550	14.2 x 21.7"	10	20.22

**SUGATSUNE FOLDING BRACKET**

Stainless Steel

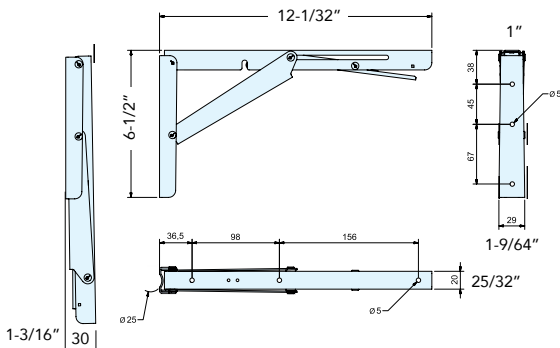

- Automatically locks when flap is in opened position
- Depress lever to release the lock
- Bracket with hinge function in one unit

Code	Finish	Load cap	Ctn	List/ea
EB-303EP	Pol. Stainless Steel	330 lbs.	25	\$ 43.25

**FOLDING SHELF BRACKET**

Parker

1794

This folding steel shelf bracket is ideal for folding tables, work surfaces, book shelves or anywhere a foldaway shelf is required. 110 lb. load rating per pair.



Locks automatically in open position. Gray enamel finish.

Code	Size	Ctn	List/pr
1794-8	8" x 8"	12 pr.	\$ 20.16
1794-12	12" x 12"	6	27.55
1794-16	16" x 16"	6	37.87

**FOLDING SHELF BRACKET**

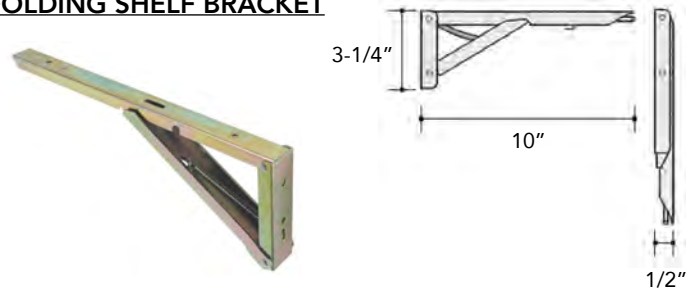

Hinged spring brackets are especially suitable for extending tables or worktops. Locks into upright position automatically. Light pressure on release button allows fold-down positioning. Steel, yellow chromated finish. 88 lbs per pair weight capacity. Use 2 each #10 and 3 each #6 panhead screws (not provided) to install.

Code	Description	Ctn	List/ea
FT65795	10" Steel Folding Shelf Bracket	10 ea.	\$ 23.88

**NON-ADJUSTABLE SHELF BRACKET**

Parker

Gray enamel finish, 24 each/box. Screws not included.



Code	Size	Ctn	List/ea
1785	5" x 6"	24 ea.	\$ 1.27
1788	8" x 10"	24	1.78
1792	12" x 14"	24	4.84

## FLOATING SHELVES



### CONCEALED FLOATING SHELF BRACKETS

Concealed, Heavy Duty

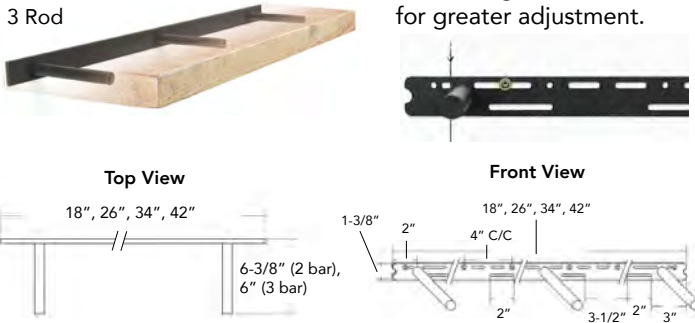

Fits Hollow & Solid Floating Shelves

- 1/4" thick steel black bar
- Supports shelves 2" thick or more and from 7" to 14" deep
- 45 lbs. capacity per rod
- Elongated screw holes
- Rods are set 2" C/C from each end, 3/4" dia, and countersunk screw holes are 3/16" OD



2 Rod	Length	Load Cap	List/ea
1806BL-2	18"	90 lbs.	\$ 122.93
2606BL-2	26"	90	153.96
3 Rod			
3406BL-3	34"	135	178.62
4206BL-3	42"	135	207.53

\* Does not include shelf or screws

### CONCEALED FLOATING SHELF BRACKETS

Made in USA

Concealed Med & Heavy Duty Brackets



Fits Hollow Slabs, Solid Beams & Aproned Surfaces

- Up to 18" (MD), 24" (HD) Deep & Any Length
- Supports mantel, shelves and desks from 9" to 24" deep
- Fits materials 1-1/2" to 4" thick
- Steel mounting plate is 1/4" thick x 12" long x 3" wide and mounts to side of stud

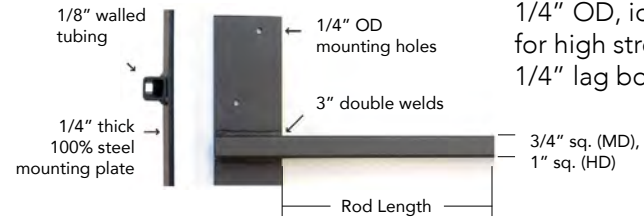

- Screw holes are 1/4" OD, ideal for high strength 1/4" lag bolts

Code	Rod Length	Load Cap	List/ea
3406BL Med Duty	6"	68 lbs.	\$ 61.20
3410BL Med Duty	10"	55	73.37
3414BL Med Duty	14"	50	84.70
3416BL-HD Heavy Duty	16"	70	115.00
3420BL-HD Heavy Duty	20"	60	125.00

\* Does not include shelf or screws

## FLOATING SHELVES

Create an elegant and clean style in your space. Easy to install and lightweight design - expand your storage space while adding a fresh modern touch.

Stocking 5 sizes in an unfinished maple veneer with maple edging.

**Includes 1 shelf and 1 mounting bracket.**



All Floating Shelves 2" Thick & 11-5/8" Deep

Code	Description	Load Cap*	List/ea
FS240-MA	Maple Shelf, 23-3/4" W	20 lbs.	\$ 226.50
FS300-MA	Maple Shelf, 29-3/4" W	25	234.18
FS360-MA	Maple Shelf, 35-3/4" W	30	259.46
FS420-MA	Maple Shelf, 41-3/4" W	35	272.46
FS480-MA	Maple Shelf, 47-3/4" W	40	296.00
FS600-MA	Maple Shelf, 59-3/4" W	50	392.68

\* Weight ratings are based on loads being evenly distributed over the shelf.

## FLOATING SHELVES

### FLOATING SHELF BRACKET

FS-BR

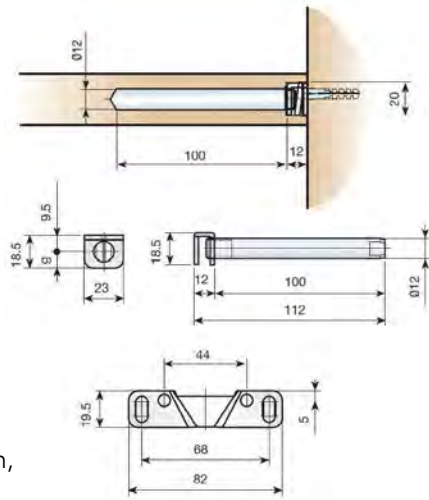

Up to 8" Shelf Depth,  
 Load Cap: 37.4 lbs.  
 per pair of brackets\*

Up to 12" Shelf Depth,  
 Load Cap: 25.3 lbs.  
 per pair of brackets\*

\* Based on 35" Length shelf with 2 brackets.

For every 18" additional length, add 1 additional bracket.

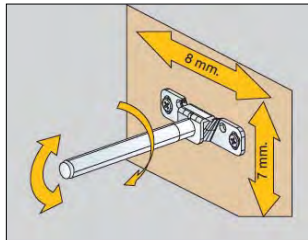

Oval holes allow accurate leveling. It can be horizontally adjusted +/- 5° by moving the rod along the support.

The 90° angle may be easily adjusted +/- 5° just by turning the rod.

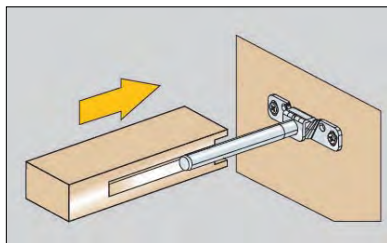

Place the shelf in position. This can subsequently be removed whenever necessary to carry out further adjustments.

Each bag contains:  
 1 support, 4 plastic wall plugs, and 4 screws.

Code	Description	Ctn	List/bg
FS-BR	Floating Shelf Bracket	25 bgs.	\$ 9.52

### FLOATING SHELF BRACKETS

Innovashelf



TLOC1515-10



- Designed for shelves 2" thick or more
- 2 piece design for easy installation in wood studs
- Wood stud weight rating 300 lbs per pair of brackets
- Includes all hardware to mount and secure shelves
- Easy adjustability during and after installation

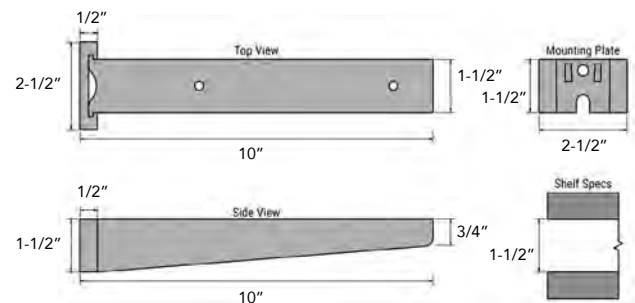

Code	Description	List/pr
TLOC1515-10	10" Floating Shelf Bracket	\$ 100

### FLOATING VANITY BRACKETS

Innovashelf



14

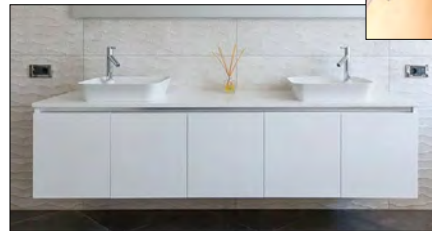

FVB-1521

- Available in kits for vanities 15 - 84" wide
- Width easily adjusts to accommodate any size cabinet
- Compatible with hardwood, plywood, MDF and particle-board cabinets

Code	Min-Max Vanity O/A Width	Load Cap	List/st
FVB-1521	15 - 21"	500 lbs.	\$ 120
FVB-2129	21 - 29"	500	140
FVB-2942	29 - 42"	1000	164
FVB-4256	42 - 56"	1000	185
FVB-5684	56 - 84"	1000	214



## SUPPORTS

### OMEGA SUPPORT BRACKETS

Pack: 2 brackets, Full Cartons Only



#### S1101 Support Bracket

10" Ht x 2" W x 8" Depth

#### S1102 Support Bracket

8" Ht x 2" W x 6" Depth

Code	Description	List/ea
S1101MUF2	Maple	\$ 27.81
S1101QUF2	Alder	32.05
S1102MUF2	Maple	25.40
S1102QUF2	Alder	22.64

### WALL CABINET HANGING SYSTEM



TH40(L/R)

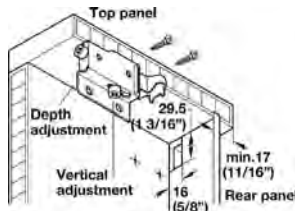

Suspension brackets are handed (left or right) and are 100% steel construction. They attach on the inside of each cabinet side panel, allowing the cabinet to be secured to the hanging rail. Suitable for medium duty (280 lb) use and require a cover cap.



Caps available in White, Black and Almond colors. Handed.



#875-Z1-24  
 Wall Mounted Hanging Strip, Galv. Steel. 2.5 meters (8'2")

Code	Description	Ctn	List/ea
TH40-L/R	Hanging Brackets (choose L or R)	200	\$ 5.45
TH40-AL-LH/RH	Cover cap, Almond	200	.95
TH40-WH-LH/RH	Cover cap, White	200	1.03
TH40-BL-LH/RH	Cover cap, Black	200	.95
875-Z1-24	Hanging Strip, Steel	10	16.93

## CABINET HANGERS

### ALUMINUM HANGING RAILS & CLIPS

Heavy Duty

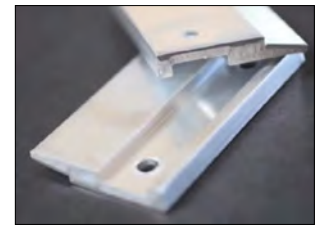
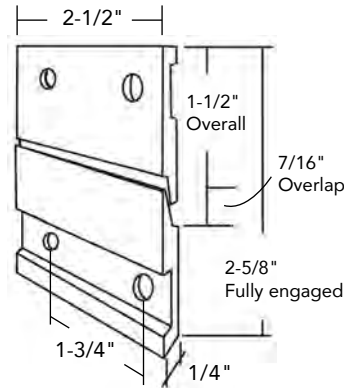

HC2 Clips - 2-1/2" width  
 Sold per pair

Two interlocked clips shown.

### HC1 Rails

12' lengths,  
 No holes  
 Sold per each

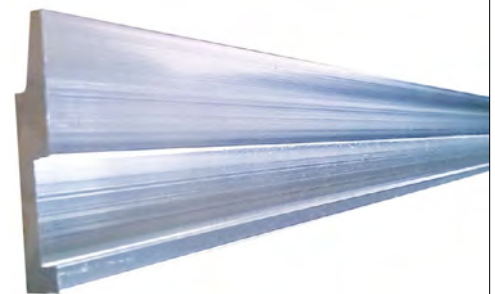

Excellent for hanging wall panel systems, elevator panels, cabinetry door displays, speaker panels, blind panels, secret panels, etc.

This aluminum extrusion provides a simple, secure and concealed installation. Provides easy panel removal for mechanical access, remodeling or refinishing. Clips are 2-1/2" wide, 1-1/2" high, with holes and sold in pairs. Rails are 144" (12') lengths, without holes and sold per each. Screws not included. Clip can use up to a #10 pan-head screw.

Clips allow slim 1/4" clearance, side to side adjustability and high load capacity.

Code	Description	Ctn	List
HC1	144" (12') Hanging Rail	10 ea.	\$ 55.42/ea
HC2	2-1/2" Hanging Clip	24 pr.	3.13/pr

## TV LIFTS

### FLAT SCREEN TV LIFT

Takes Flat Screen TVs up to 48"



### Special Order Only

4050WR

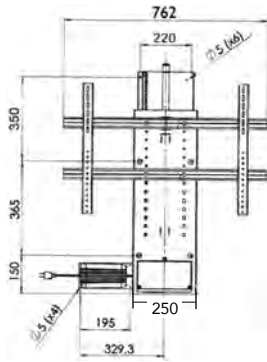

Total Travel: 29.5"

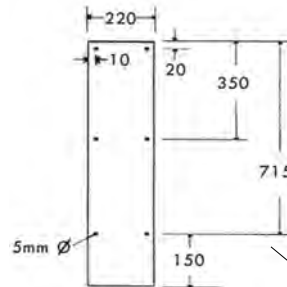
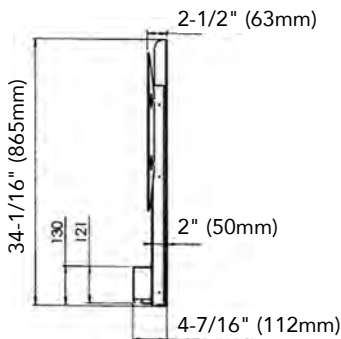

Back Panel  
 Mounting Holes

Overall Extended Height: 58-1/8"  
 Unit Weight: 40 lbs.

Min. Height closed: 34-1/16"

Weight Capacity:  
 145 lbs.

"Whisper Quiet"  
 Operation

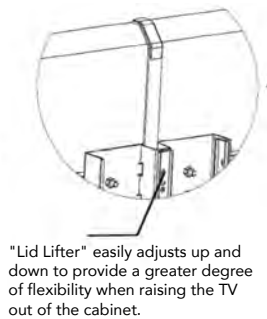
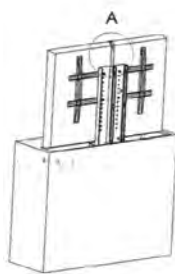

"Lid Lifter" easily adjusts up and down to provide a greater degree of flexibility when raising the TV out of the cabinet.

- High quality German Bosch motor for whisper quiet operation
- Ball-bearing guide system for added stability
- Requires only 2-3/4" of depth behind the TV
- Weight Capacity: 145 lbs.
- Can be easily mounted by one person in minutes using only a screwdriver
- Radio command remote control with manual override switch included.
- UL Listed, 34-1/16" Closed Ht.

**Special Order Only**

Code	Description	List/ea
4050WR	Flat Screen TV Lift	CALL

### WHISPER RIDE 1000

For 50" to 70" Flat TVs

### Special Order Only



WR1000

For 50" to 70" TVs



Min. Height closed: 29-1/2"



### Features

- Quiet operation, 1.1"/sec
- Rack and pinion design with unique stability system
- Reverse safety function
- Requires only 2-13/16" depth behind the TV
- Weight capacity: 145 lbs.
- 39-3/8" of travel
- Simple and fast mounting
- IR remote available
- Anti-pinch safety protection
- UL listed power supply

Complete inside  
one carton:

Code  
 WR1000

List  
 CALL

- Remote control (RF)
- Manual push switch
- Adjustable lid lifter
- Plug and play assembly
- Universal TV mounting bracket

**Special Order Only**



# Luxe

## High Gloss Custom Door & Drawer Fronts

LUXE is an advanced decorative panel with a high gloss finish on one face, while the back is a matching decorative matte melamine in the same design.



- 3/4" MDF Core
- High Gloss Polyester Front / Matte Back
- Two Edgebanding options (solid and bi-color)
- Separate edgebanding & boards available

This product is more durable than alternative products; highlighting its scratch-resistance, surface quality, high brightness as well as light stability towards colors.

These qualities make it well suited for vertical applications in kitchen, bathroom, office and home furniture.

14 The LUXE manufacturing process allows solid colors plus a wide range of designs, such as wood, marble, stone, fantasy etc. This makes LUXE a highly versatile and decorative product.

Can be supplied in panels or in edged pieces. For this last option, LIOHER uses PUR technology in order to offer its product the finish according to its quality.



**Luxe Doors & Fronts**

**List**

Colors & Patterns

\$ 23.94 / sq ft.



## High Gloss Custom Door & Drawer Fronts Colors and Designs

### Solids



Blanco

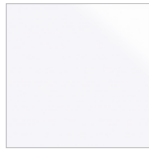

Blanco Polar



Magnolia



Gris Perla



Gris Nube



Gris Metallic

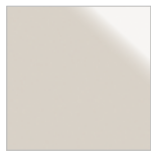

Cashmere



Basalto



Gris Plomo



Azul Marino



Azul Indigo



Antracita



Agua Marina



Verde Salvia

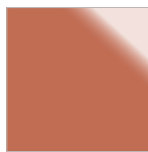

Cotto



Rojo



Curry



Black

### Patterns

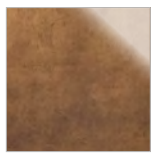

Cuzco Oro

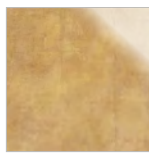

Cuzco Royal Gold

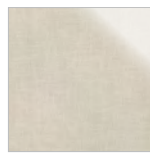

Textil Plata



Textil Grafito



Roble Frappe



Olivo



Guayana

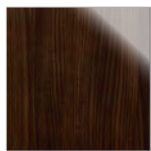

Olmo

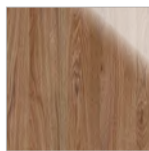

Nogal Rosales 02

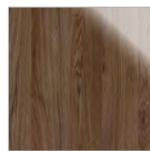

Nogal Rosales 03

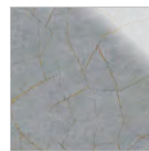

Porcelain 01 Gold

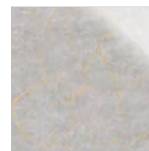

Porcelain 02 Gold

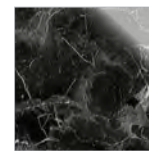

Oriental Black

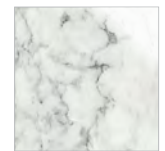

Oriental White



Blanco  
Pearl Effect

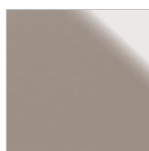

Basalto  
Pearl Effect

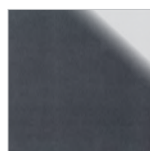

Antracita  
Pearl Effect



Metallo 1

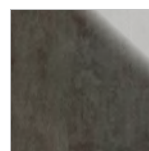

Metallo 2

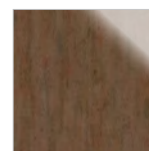

Metallo 3



Metallo 4



# SYNCRON

structured panel LINE

## Textured Melamine Panels Door & Drawer Fronts



SYNCRON STRUCTURED PANELS gives a natural and highly decorative texture to panels, door fronts and drawer fronts.

- Textured Melamine Front
- 3/4" Particle Board Core
- Includes matching edgebanding on cut to size pieces
- Cabinets, furniture, interior decorative projects
- Grain matching (sequenced) available at an extra cost

### Syncon Doors & Fronts List

Textured \$ 15.83 / sq ft.

#### Natural Wood



Blanco  
Natural Wood

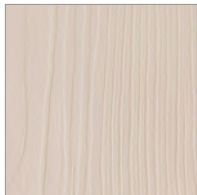

Cashmere  
Natural Wood

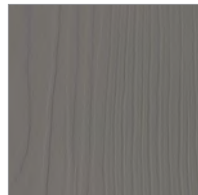

Gris Plomo  
Natural Wood



Antracita  
Natural Wood

#### Évora



Évora 3

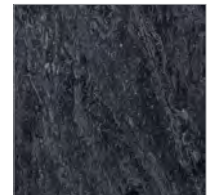

Évora 4

#### Roble Muratti



Roble  
Muratti 4

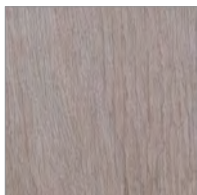

Roble  
Muratti 1

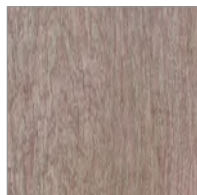

Roble  
Muratti 2

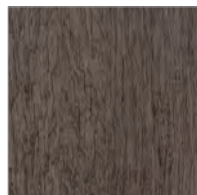

Roble  
Muratti 3

#### Roble Frappé

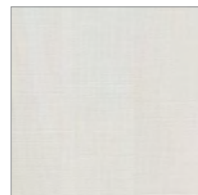

Roble  
Frappé 1



Roble  
Frappé 2



Roble  
Frappé 3



**Olmo**

**Ida**



Olmo 1

Olmo 2

Olmo 3

Ida 1

Ida 2

Ida 3

Ida 4

**Ice Cream**

**Woodline**



Ice Cream 1

Ice Cream 2

Ice Cream 3

Ice Cream 4

Woodline 01

Woodline 03

**Lakeland Oak**

**Nocce**

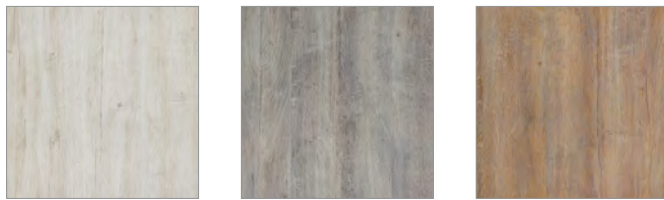

Lakeland Oak 1

Lakeland Oak 2

Lakeland Oak 3

Nocce 1

Nocce 2

Nocce 3

**Anniversary Oak**

**Como Ash**

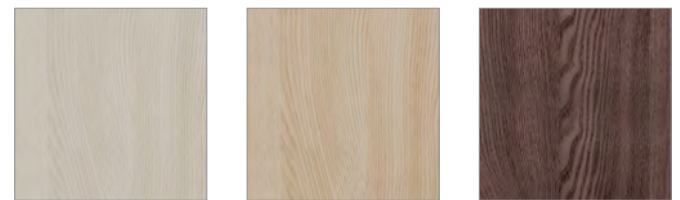
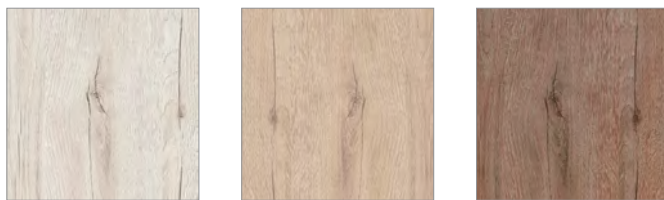

Anniversary Oak 1

Anniversary Oak 2

Anniversary Oak 3

Como Ash 1

Como Ash 2

Como Ash 3

**Oxid**

**Carolina**

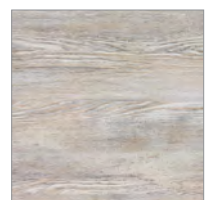

Oxid 1

Oxid 2

Oxid 3

Oxid 4

Carolina Pine Sierra



# Zenit

## Supermatt High Resistance Surface Door & Drawer Fronts



Beauty is not always delicate - meet the toughest matte design boards. In contrast to the Luxe lacquered panels, Zenit offers a deep, super matte finished panel with a silky soft feel and excellent resistance to abrasion. Recommended for use in the manufacture of all kinds of furniture and decorative products.

The Zenit collection comes in a complete range of solid colors, with or without metallic particles (Supermatt or MetalDeco), and elegant designs such as the marbles. These designs provide a more subtle, yet sleek look for modern kitchens, bath and home furniture as well as in interior design and commercial projects.

### Supermatt

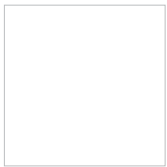

Supermatt  
Blanco

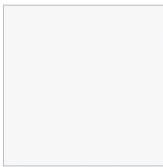

Supermatt  
Blanco Polar

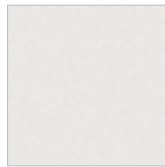

Supermatt  
Gris Perla

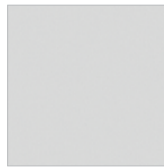

Supermatt  
Gris Nube

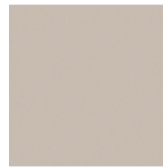

Supermatt  
Cashmere



Supermatt  
Basalto



Supermatt  
Gris Plomo



Supermatt  
Agua Marina



Supermatt  
Azul Indigo



Supermatt  
Azul Marino



Supermatt  
Antracita

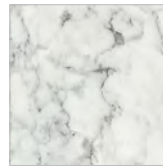

Supermatt  
Oriental White



Supermatt  
Oriental Black



Supermatt  
Black



Supermatt  
Cotto



Supermatt  
Verde Salvia



Supermatt  
Tortora

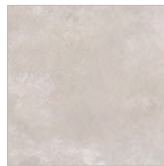

Supermatt  
Titan 01

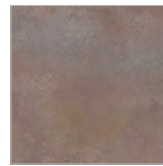

Supermatt  
Titan 03

### Metaldeco



MetalDeco  
Blanco SM



MetalDeco  
Antracita SM



MetalDeco  
Basalto SM

### Zenit Doors & Fronts List

Colors & Patterns \$ 23.94 / sq ft.



# CAVA D O O R S

## Traditional Solution & Advanced Technology

CAVA DOORS are designed to marry the traditional look with the advanced surfaces of ZENIT and SYNCRON. Available in 3, 5, 7 and 9 piece doors.



Cava Doors	List
Cava Zenit	\$ 34.66 / sq ft.
Cava Synchron	27.33 / sq ft.



Blanco Supermatt  
Cava



Basalto Supermatt  
Cava



Muratti 1 Texture  
Cava



Ida 3 Texture  
Cava



Frappe 3 Texture  
Cava

## Finger-Pull

Integrated handle



The Finger-Pull "J profile" provides modern aesthetics and ergonomics, perfectly adapted to the minimalist trends and straight lines the current market demands.



Blanco



Olmo 3



Frappe 1



Muratti 1

Finger Pulls	List
Luxe J-Pull	\$ 34.29 / sq ft.
Synchron J-Pull	30.79 / sq ft.
Zenit J-Pull	34.29 / sq ft.





## **NORTHERN CONTOURS Cabinet Doors and Drawers**

Northern Contours is the largest U.S. manufacturer of thermofoil cabinet doors and accessories. All orders are custom made and drop-shipped to the cabinet-maker within a 10 day lead time.

Find the perfect door style with Northern Contours' extensive selection of contemporary, transitional and traditional thermofoil cabinet doors and drawer fronts. 1-piece components are available in any of the standard thermofoil offerings including the latest in print technology with a variety of realistic woodgrains, textures, high gloss, and satin foils.

Go to [www.northerncontours.com](http://www.northerncontours.com) to see all available series, profiles, materials and finishes. The following are just a few examples.



### **Thermofoil Cabinet Doors and Drawer Fronts**

#### **Contemporary Series**

Cortina

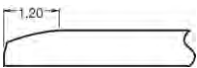
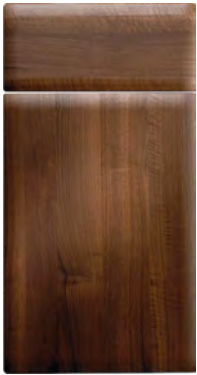

Elegante II

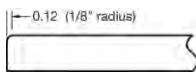
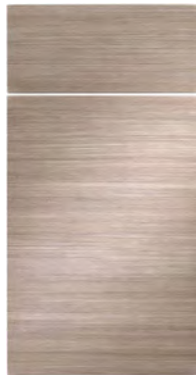

Italia II

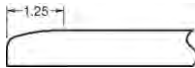
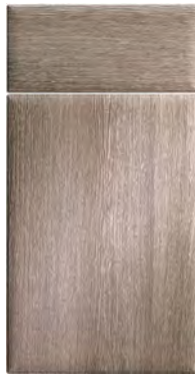

Novara

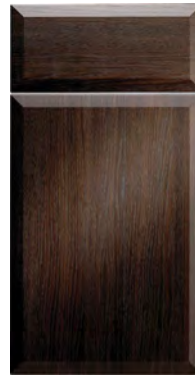

Turino

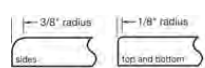
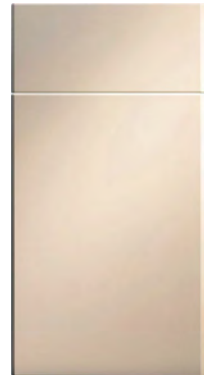

14

#### **Shaker Series**

Shaker

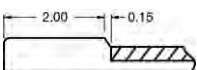

Lancaster

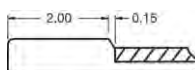
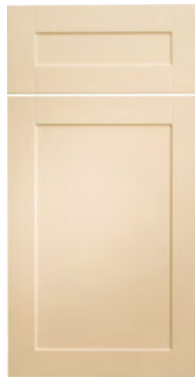

Lancaster Elite

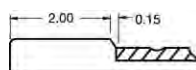
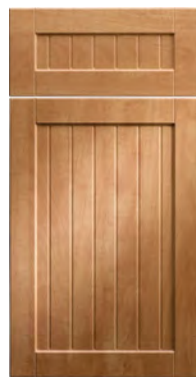

Bradford

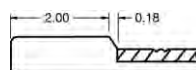
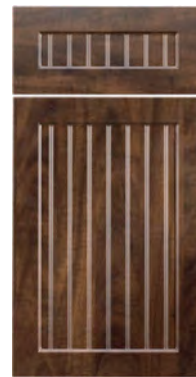



**NORTHERN CONTOURS Cabinet Doors and Drawers cont.**

**LEVEL Doors and Drawer Fronts**

For fresh modern designs, look no further than LEVEL, a series of flat laminated and edgebanded doors. Ultra high gloss acrylic, heavily textured melamine and the latest in linear and matte thermofoils along with 4 different edgebanding options offer you endless design combinations.

Go to [www.northerncontours.com](http://www.northerncontours.com) for a full materials listing.

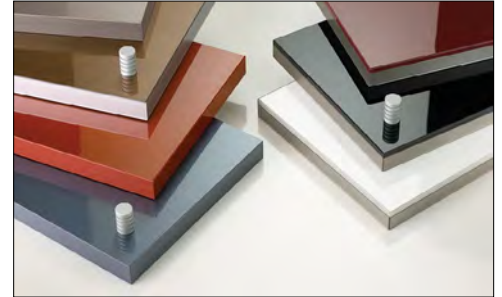

**3DL Thermofoil**

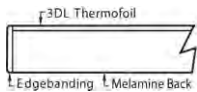

Thermofoil on the face with a melamine back. ABS/PVC edgebanding options include Matching, 3D Aluminum, or Steel Gloss.

Entire thermofoil line of accessories is available including frame doors, mouldings, valances, fillers, overlays, Norlam, PSA and cut to size panels in various thicknesses.

**Acrylic and Wired**

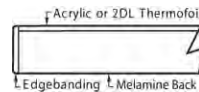

Ultra high gloss acrylic on the face with a melamine back. ABS edgebanding options include Matching, 3D Aluminum, Steel Gloss, or 2-Part (on White, Black, Ruby Red, Glass Green and Dark Grey).

Accessories are limited to overlays, cut to size panels, Norlam and PSA.

**Impressions**

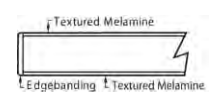
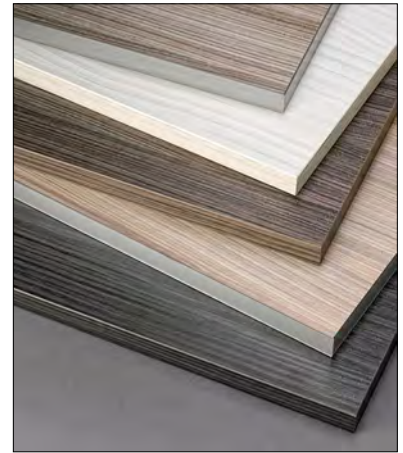

Textured melamine on the face and back. ABS edgebanding options include Matching, 3D Aluminum, or Steel Gloss.

Entire thermofoil line of accessories is available including frame doors, mouldings, valances, fillers, overlays, Norlam, PSA and cut to size panels in various thicknesses.

**Edgebanding Options**



2 Part



3D Aluminum



Matching



Steel Gloss



**EFI**



### EFI Aluminum Frames for Cabinet Doors



- Doors ship fully assembled
- Quick delivery
- Tempered safety glass
- No minimum orders
- Made in the USA
- Multiple glass types available

**All Special Order:**

4 weeks of production,  
1 week of shipping.

Expedited service available:  
2 weeks of production.

**Profile Finishes:**

- Clear Anodized Aluminum
- Stainless
- Polished
- Powder coating:
  - White
  - Dark Bronze
  - Black
  - Charcoal

**Frame Profiles** 4mm inserts

1505 (Air Thin)

Door



1927

Door Drawer



1530 (Air)

Door



1930

Door

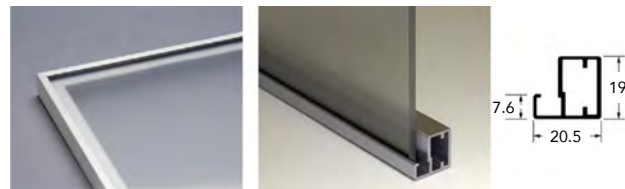

1905

Door

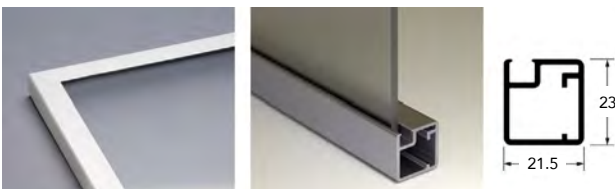

1933

Door

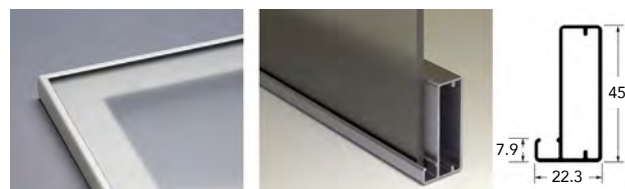

1919

Door Drawer



1936

Door Drawer

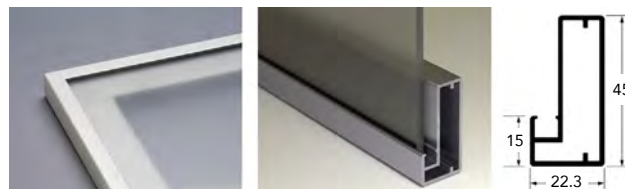



**Frame Profiles** 4mm inserts *continued*

**EFI**

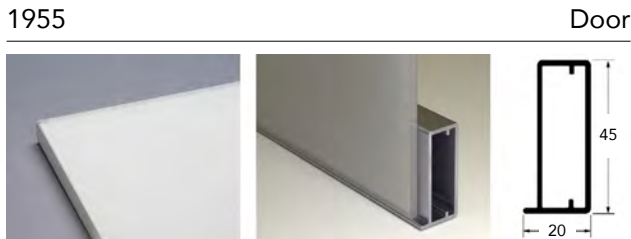
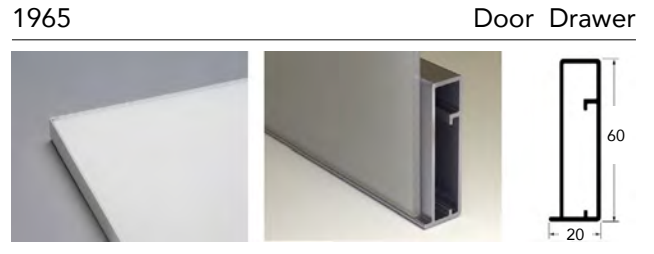
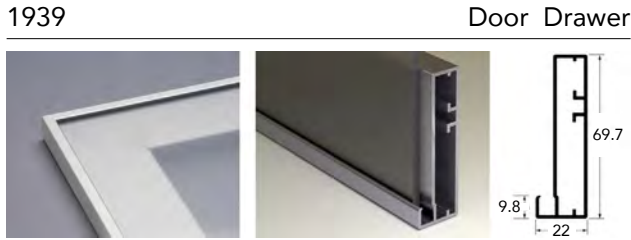

**EFI Base Glass Options for Aluminum Frames**

- All glass is tempered safety glass
- Choose from different glass thicknesses: 4, 6, 10, 12 mm
- Low iron backpainted glass inserts available

**Clear Glass**

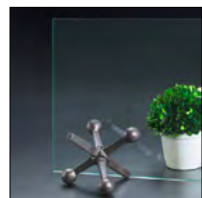

Clear - Standard

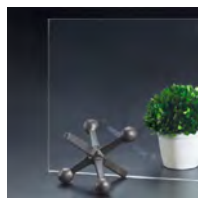

Clear - Low iron

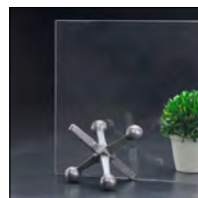

Clear - Grey Tinted

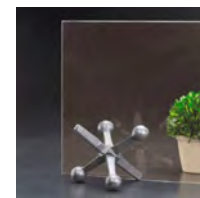

Clear - Bronze Tinted

**Pattern Glass**

Many choices of Pattern Glass are available.



Barcode  
 shown vertical



Fabric

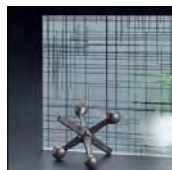

Linen

**Colored Glass and Ecoresin Panels**

Many choices of Colored Glass and Ecoresin Panels are available.

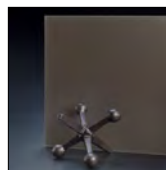

Dark Brown  
 (2895)



Red (3950)

Panels avail. in 4' x 8' sheets, cut to size.



Swept Silver

See order form in back of catalog



**ApplePly<sup>®</sup>** by States Industries

**DRAWERS**

**WHITE MAPLE APPLE PLY DRAWER SIDES**

Full Cartons Only

- Available in 4 popular heights (1/2" thickness)
- Bullnosed edge
- Prefinished to enhance Maple face veneer
- Clear, durable UV cured finish



8' Lengths  
10 each/ctn.  
Full Cartons only



Grooved

**APPLE PLY QUALITY SELLS:**

When people inspect a piece of furniture or cabinetry, the first thing they often do is open a drawer. Real Wood stands out; in a world of vinyl wraps, the demand for real wood products has never been greater. ApplePly sides take screws easily and accept the better quality slides. Clear UV finish on White Maple looks great, stays hard and resists water and household spills.



**BULLNOSE EDGE**

**9-PLY MAPLE, 1/2" THICKNESS, 8' LENGTH**

10 each/ctn. Full Cartons only

<u>Code</u>	<u>Height</u>	<u>Description</u>	<u>List/ea</u>
AP4M8G	4"	Bullnose, Grooved	\$ 51.42
AP6M8G	6"	" "	73.93
AP8M8G	8"	" "	90.73
AP10M8G	10"	" "	61.75

**DRAWER BOTTOM STOCK - 3-PLY MAPLE**

Finished on one side only. Full Cartons Only.

<u>Code</u>	<u>Size</u>	<u>Ctn</u>	<u>List/ea</u>
AP44M3	1/4" x 4' x 4'	7 pcs.	\$ 50.40

**DRAWERS:** Pre-Assembled & Machined for Quadro, Grass, Enterprise and Salice Slides.



**Materials:** Solid Maple, Melamine, Maple 9-ply prefinished and unfinished, 7-ply prefinished Maple, MDF and more.

**Construction:** Dovetail, Butt Joint or Dowelled.

**Customer Specs:** Boxes guaranteed to size within 1/32" width, 1/16" height and 1/8" depth. All dimensions are O.D.

Fax Orders to: 415-552-8577  
or Email: orders@macmurraypacific.com

**See the following pages for Drawer Box Order Forms:**

Cimarron Drawers (pg 1428)

California Drawers (pg 1429)

California Dovetail (pg 1430)

Drawer Box Specialties (pg 1431)

Western Dovetail (back of catalog)



CIMARRON

**CIMARRON DRAWER**

**MacMURRAY PACIFIC**

568 7th Street, San Francisco, CA 94103  
 Contact Us: [orders@macmurraypacific.com](mailto:orders@macmurraypacific.com)  
 Tel (415) 552-5500 / Fx (415) 552-5840

QUOTE/ORDER FORM

DATE: \_\_\_\_\_

NAME: \_\_\_\_\_

ADDRESS: \_\_\_\_\_

CONTACT: \_\_\_\_\_ TEL: \_\_\_\_\_

EMAIL: \_\_\_\_\_ FAX: \_\_\_\_\_

QUOTE ORDER Sales Rep  
  P.O.#

FORKLIFT AVAILABLE: Yes  No

Someone ALWAYS there for Deliveries? Yes  No

SHIPPING to COMMERCIAL AREA

SHIPPING to RESIDENTIAL AREA

DRAWER SIDE THICKNESS		
3/4"	5/8"	1/2"
<input type="checkbox"/>	<input type="checkbox"/>	<input type="checkbox"/>

DRAWER SIDE MATERIAL

DRAWER BOTTOM THICKNESS	
1/4" <input type="checkbox"/>	1/2" <input type="checkbox"/>

DRAWER BOTTOM MATERIAL

DRAWER BOTTOM PLACEMENT	
<input type="checkbox"/>	1/2" (STANDARD)
<input type="checkbox"/>	1/4"
<input type="checkbox"/>	FLUSH

OPTIONS			
<input type="checkbox"/>	ASSEMBLED	FRONT & BACK 1/8" HIGHER THAN SIDES	<input type="checkbox"/>
<input type="checkbox"/>	UNASSEMBLED		<input type="checkbox"/>
<input type="checkbox"/>	FINISHED		<input type="checkbox"/>
<input type="checkbox"/>	UNFINISHED		<input type="checkbox"/>
<input type="checkbox"/>	NOTCH FOR UNDERMOUNT SLIDES		<input type="checkbox"/>
<input type="checkbox"/>	ATTACH CLIPS - Brand:		<input type="checkbox"/>
<input type="checkbox"/>	SCOOP FACE	DOVETAIL	<input type="checkbox"/>
<input type="checkbox"/>	PRE-DRILL SUB-FACE	DOWEL	<input type="checkbox"/>

\*\*Note PULLOUT drawers in SPECIAL INSTRUCTIONS column\*\*

QTY	WIDTH	DEPTH	HEIGHT	SPECIAL INSTRUCTIONS

SPECIAL INSTRUCTIONS: \_\_\_\_\_



Order

Quote

## MacMURRAY PACIFIC



Order Date \_\_\_\_\_

Date Due \_\_\_\_\_

PO No. \_\_\_\_\_

### MacMurray Pacific

568 7th St. SF, CA 94103

Phone: 415-552-5500

Fax: 415-552-5840

Email: orders@macmurraypacific.com

Company:				
Street:				
City:				
State:		Zip:		
Tel:		Fax:		
Contact:				
	W	D	H	Qty
1				
2				
3				
4				
5				
6				
7				
8				
9				
10				
11				

Material Thickness		Edge Preference	
1/2"	<input type="radio"/>	1/8" Round Over	<input type="radio"/>
5/8"	<input type="radio"/>	Eased Edges	<input type="radio"/>

Side Material			
Solid Maple	<input type="radio"/>	9 Ply Russian Birch	<input type="radio"/>
Other	<input type="radio"/>		

Bottom Thickness		Bottom Material	
1/4	<input type="radio"/>	Maple Ply	<input type="radio"/>
1/2	<input type="radio"/>	Melamine	<input type="radio"/>
		Other	<input type="radio"/>

Slides		Corners	
Side/No Notch	<input type="checkbox"/>	Dovetailed	<input type="radio"/>
Grass DynaPro	<input type="checkbox"/>	Butt Joint	<input type="radio"/>
Actro 5D	<input type="checkbox"/>	Nailed	<input type="radio"/>
Quadro IW21	<input type="checkbox"/>		

Salice A7555	<input type="checkbox"/>	Finish	
Blum Tandem	<input type="checkbox"/>	Yes	<input type="radio"/>
		No	<input type="radio"/>

Pull Outs		Scoops	
Yes	<input type="radio"/>	Yes	<input type="radio"/>
No	<input type="radio"/>	No	<input type="radio"/>

#### Provide Clips

Yes	<input type="radio"/>
No	<input type="radio"/>

#### 1/8" Step up Front & Back

Yes	<input type="radio"/>
No	<input type="radio"/>

#### Special Instructions:

California Drawers warrants the drawer box dimension and materials to be in accordance with your order. We must be notified of any discrepancy within five working days of receipt of your drawer box. No returns will be accepted unless they did not meet the order specifications.

I agree to the California Drawer terms and conditions.

Signature: \_\_\_\_\_



# California DOVETAIL Co.

Customer Account: \_\_\_\_\_

Company: \_\_\_\_\_

Street: \_\_\_\_\_

City: \_\_\_\_\_ State: \_\_\_\_\_ Zip: \_\_\_\_\_

Phone: \_\_\_\_\_ Fax: \_\_\_\_\_

Contact: \_\_\_\_\_

Quantity	W	D	H	Cabinet #

Special Instructions:

\_\_\_\_\_

\_\_\_\_\_

\_\_\_\_\_

\_\_\_\_\_

\_\_\_\_\_

Order Date: \_\_\_\_\_

ORDER

Date Due: \_\_\_\_\_

QUOTE

PO #: \_\_\_\_\_

MacMurray Pacific  
 568 7th St. SF, CA 94103  
 Ph. 415-552-5500  
 Fx. 415-552-5840  
 Email: orders@macmurraypacific.com

**Standard Specifications:**

*Top Edge: Flat Top With Eased Edge*  
*Corner: Dovetailed*  
*Bottom Material: 1/4"*  
*(drawers over 30" wide get a center strip)*  
*Bottom Construction: 1/2" Inset*

**Wood:**

Maple:  Cherry:  Walnut:   
 Aspen:  Beech:   
 Birch Plywood(1/2" sides only):

**Option:**

Scoops   
 Bottom Material: 1/2"   
 Bottom Material: 1/4"   
 Side Material: 5/8"   
 Side Material: 1/2"   
 Unfinished   
 Notch & Drill Back   
 If so, what brand? \_\_\_\_\_  
 Install Front Fixing Clips   
 If so, what brand? \_\_\_\_\_  
 Hettich Quadro 1W21   
 Hettich Quadro 1W20   
 Grass DynaPro Install Front Fixing Clip   
 Grass DynaPro Install Rear Tilt Clip

*Terms & Conditions:*  
 California Dovetail Co. warrants the drawer box dimension and materials to be in accordance with your order. We must be notified of any discrepancy within five working days of receipt of your drawer box. No returns will be accepted unless they did not meet the order specifications. Tolerances: width to 1/32", depth to 1/8", and height to 1/8".

All drawers are finished after assembly

Signature: \_\_\_\_\_

Print Name: \_\_\_\_\_

Rep Name: \_\_\_\_\_

To submit your order form, you can:  
**Email to:** orders@macmurraypacific.com  
**Fax to:** 415-552-5840





## Drawer Box Specialties

Send To:

### MACMURRAY PACIFIC

**Lead Time:** Please Allow  
5-6 working days

Ship To: Account # \_\_\_\_\_

Email: orders@macmurraypacific.com  
Fax: 415-552-5840

Order Date: \_\_\_\_\_

Account Name \_\_\_\_\_

Date Required: \_\_\_\_\_

Street \_\_\_\_\_

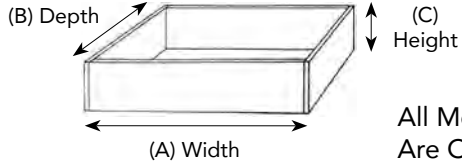

All Measurements Are Outside to Outside

City \_\_\_\_\_

State \_\_\_\_\_ Zip \_\_\_\_\_

MacPac Contact \_\_\_\_\_

MacPac # \_\_\_\_\_  **Quote Only**

Job Name \_\_\_\_\_  **Order**

**Pre-finished**

**Finish After Assembly**

Sides: (specify material & thickness)

Bottoms: (specify material & thickness)

Top Edge:

PVC Edge Tape

Flat Top

Bullnose

\_\_\_\_\_

Corner Construction :

Dovetail

Assembled

Dowel

Knockdown

Nailed

Dovetail/Dowel

Bottom Construction:

Let In 4 Sides

Let in for Quadro V6

Bottom Mount

Let in for DynaPro

Let in for Hettich IW21

Let in for \_\_\_\_\_  
Notch:  back only

Add Clips

back & front

Files:

Lateral

Standard

Letter

Legal

Both

Slot Depth: \_\_\_\_\_

Bars:  Yes  No

Special Instructions: \_\_\_\_\_

\_\_\_\_\_

\_\_\_\_\_

Qty	A Width	B Depth	C Height	Cabinet #

- DBS warranties that the drawer box dimensions and materials be to your order. Width to 1/32", Depth to 1/8", and Height to 1/8". We must be notified of any discrepancy within five working days of receipt of drawer boxes.
- No returns will be accepted unless they do not meet the order specifications.

Signature \_\_\_\_\_

**DRAWER SLIDE COMPARISON CHART**

<u>Manufacturer</u>	<u>Part No.</u>	<u>Page</u>	<u>Clearance</u>	<u>Mfg. Rated Load Cap.</u>	<u>Extension</u>
<b>Side Mount Full Extension</b>					
Pride	4903	1504	1/2"	100 lbs.	Full
KV	Tru-Trac TT100B	1504	1/2"	100 lbs.	Full
KV	DuriSlide DUR45B	1504	1/2"	100 lbs.	Full
KV	8400	1505	1/2"	100 lbs.	Full
KV	8405- Overtravel	1505	1/2"	100 lbs.	Full + 1"
KV	8450 - Soft Close	1509	1/2"	100 lbs.	Full
Fulterer	5000	1506	1/2"	100 lbs.	Full
Fulterer	5000OT - Overtravel	1506	1/2"	100 lbs.	Full + 1"
Fulterer	5045	1507	1/2"	100 lbs.	Full
Fulterer	5001ECD - Soft Close	1509	1/2"	100 lbs.	Full
Fulterer	5046ECD - Soft Close	1508	1/2"	100 lbs.	Full
Sugatsune	ESR - Stainless Steel	1507	1/2"	100 lbs.	Full
KV G-Slide	4270 - Soft Close	1510	1/2"	100 lbs.	Full
KV G-Slide	4260 - Push	1510	9/16"	100 lbs.	Full
KV	6505 - Overtravel	1511	1/2"	125 lbs.	Full +1"
Hettich	4932 - Overtravel	1511	1/2"	130 lbs.	Full + 1-1/2"
Pride	PR5000 - Overtravel	1512	1/2"	150 lbs.	Full + 1-1/2"
KV	8505 - Overtravel	1512	1/2"	150 lbs.	Full + 1-1/2"
KV	8810	1513	3/4"	200 lbs.	Full
KV	8815 - Overtravel	1513	3/4"	190 lbs.	Full +1"
Fulterer	5210 / 5210ECD - Soft Close	1514	1/2"	200 lbs.	Full +1"
Pride	5890	1515	3/4"	250 lbs.	Full
Fulterer	5400	1515	3/4"	550 lbs.	Full

**Hole Patterns for Side Mount Slides** pgs 1570-1585

**Undermount Concealed Slides**

Houck 500	522	1503	7/16"	50 lbs.	3/4"
Salice	A7555/A6555 - Soft Close	1537-38		75 lbs.	Full
Salice	A7557 - Push	1549		75 lbs.	Full
King	1A68F - Soft Close	1546		75 lbs.	Full
Pride	9800 Soft Close	1545		90 lbs.	Full
Hettich	Quadro IW21 2D	1529-30		90 lbs.	Full
Hettich	Quadro IW21 4D	1531-32		100 lbs.	Full
Hettich	Quadro IW20 4D	1533		100 lbs.	Full
Hettich	Quadro IW20/21 4D - Push	1550		100 lbs.	Full
Grass	DynaPro/DP-3D/DP-HD	1541-44		100 / 132 lbs.	Full
Hettich	Actro 5D	1535-36		88 / 154 lbs.	Full
Salice	F70 HD Soft Close	1539-40		154 lbs.	Full

**Drawer Box Reduction Chart** pg 1528  
**Rear Notch/Drilling** pg 1534  
**Quadro Mounting Hole Setbacks/ Cross Sections** pg 1570

**DRAWER SLIDE COMPARISON CHART**

<u>Manufacturer</u>	<u>Part No.</u>	<u>Page</u>	<u>Clearance</u>	<u>Mfg. Rated Load Cap.</u>	<u>Extension</u>
<b>European / Epoxy Enamel White</b>					
Salice	A208	1516	1/2"	75 lbs.	3/4
Fulterer	FR1921	1516	1/2"	75 lbs.	less 4"
KV	1805	1517	1/2"	75 lbs.	less 4"
Grass	5300	1517	1/2"	125 lbs.	Full
<b>Top Mount / Center Drawers</b>			<b>Description</b>		
Fulterer	5162	1503	Pencil Tray Slide	75 lbs.	3/4
Fulterer	5060	1561	Keyboard Slide	75 lbs.	less 5-1/2"
KV	8150	1561	Keyboard Slide	75 lbs.	less 5-1/2"
<b>Specialty Slides / Arms / Lifts</b>					
KV	8071	1551-52	Flipper Slides	30 lbs.	
KV	8091	1553-55	Flipper Slides	75 lbs.	
Sugatsune	IF-360W	1557	Flipper Door Mechanism	var.	
Weber	29155-2	1563	Keyboard Mini-Arm		17-3/4"
Weber	22805	1563	Keyboard Arm		17-3/4"
KV/Waterloo	6000 Series	1562	Keyboard Arm		
Workrite	180 Series	1564	Keyboard Platform		
KV	KD1000	1565	Keyboard System	75 lbs.	
KV/Waterloo	7351D	1564	CPU Holder	85 lbs.	
Houck	BB Slide	1561	Bread Board Slide	30 lbs.	3/4
Rev-A-Shelf	RAS-ML-HDCR/SC	1557	Appliance Lift	60 lbs.	
Salice	A65559	1558	Pull-Out Shelf Slide	66 lbs.	Full
KV	8407	1558	Pull-Out Shelf Slide	100 lbs.	Full
KV	8000	1559	Pantry Slide	130 lbs.	
Fulterer	FR771 / FR777A	1560	Pantry Slide	275 / 450	Full
<b>Drawer Systems</b>					
Grass	Zargen 6036	1526-27	5/8"	100 lbs.	less 4"
Grass	Zbox	1518-21		100 lbs.	Full
Grass	Vionario	1522-24	1/2"	100 lbs.	Full
Salice	Lineabox	1525			
Pride	Double Wall System	1527			

**DRAWER SLIDE CROSS REFERENCE CHART**

## Side Mount

<u>Description</u>	<u>KV #</u>	<u>Fulterer #</u>	<u>Other</u>	<u>Accuride*</u>
Pencil Drawer, 3/4 Ext, 75 lbs.	8250*	5162		2006
Box Drawer, 3/4 Ext, 75 lbs.	8300*			2037
Low Profile, Full Ext, 75 lbs.	4400*	5036*		2632, 3732
Full Ext, 100 lbs.	8400	5000		3832
Full Ext, 100 lbs, Value	TT100B	5045		4500 "Bee"
Full Ext, 80 lbs, Value	DU45B			Eco-Slide
Over-Travel, 100 lbs.	8405	5000OT		3833
Soft-Closing, 100 lbs.	8450, GS4270	5001ECD, 5046ECD		3832EC
Push, Full Ext, 100 lbs.	8430*, GS4260			3832TR
Top Rail, OT, 125 lbs.	6505			3017 (100 lb)
Over-Travel, 130 lbs.			4932 (Hettich)	7434
File Drawer, 150 lbs.	8500			4032
File Drawer, OT, 150 lbs.	8505		PR5000 (Pride)	4034
File Drawer, Prog, 175 lbs.	8520 (Full Ext)* 8525 (OT)*			4437
Heavy Duty, OT, 190 lbs.	8815			3640 (7/8")
Heavy Duty, 200 lbs, 1/2"		5210, 5210ECD (Soft Close)		7957 (3/4")
Heavy Duty, Full Ext, 200 lbs.	8810			3600 (3/4")
Heavy Duty, up to 500 lbs.	8900*	5400		9301 (3/4")
Keyboard	8150	5060		2109
Keyboard	KD1000			Ergo 200
Pantry	8000 (130 lbs.)	FR771 (275 lbs.) FR777A (450 lbs.)		301-2590
Pull-out Shelf	8407			322D
Flipper	8071			1234
Flipper	8091			1432
Monorail, 50 lbs. (centermount)	1129*	5090*		1029

\* Non-stock



### 3/4 EXTENSION DRAWER SLIDES

#### HOUCK GO-EZ 500 SERIES SLIDE

3/4 Extension, Bottom Mount, Load Capacity: 50 lbs.

#### Houck 500

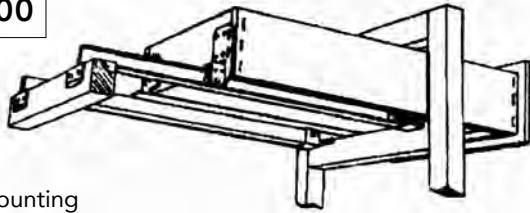

Metal Rear Mounting  
Bracket Options

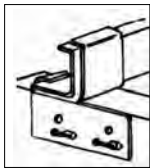

Rear of Rail

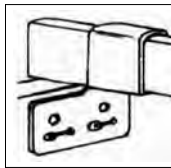

Front of Rail

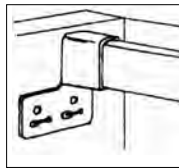

Directly to Strongback

#### Drawer Clearance

Combined total clearance between drawer side height and cabinet opening is 7/16" min.

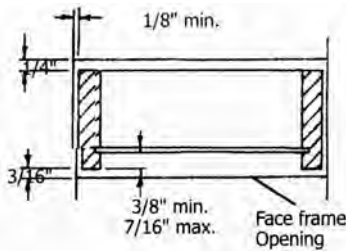

Houck's 500 Series bottom mount provides maximum drawer width and balanced load support with 4-point suspension. The captive channel track reduces side play. Polypropylene wheel provides silent drawer action. The standard metal rear bracket applies three different ways (as pictured). Bright Satin finish.

15 Pack: 20 sets

Code	Drawer Track x Cabinet Track	List/st
522P	22" x 22-1/2"	\$ 12.25

#### DRAWER SOCKET SCREWS

Truss head, sharp tipped, deep thread screw for rear drawer mounting sockets. Phillips drive.



Code	Drive	Size	Ctn	List/M
6802	Phillips	#8-3/4"	10000	\$ 28.64
7892	Phillips	#8-5/8"	10000	32.96

#### FILTERER 5162 PENCIL TRAY SLIDE

Load Capacity: 75 lbs, 3/4 Extension

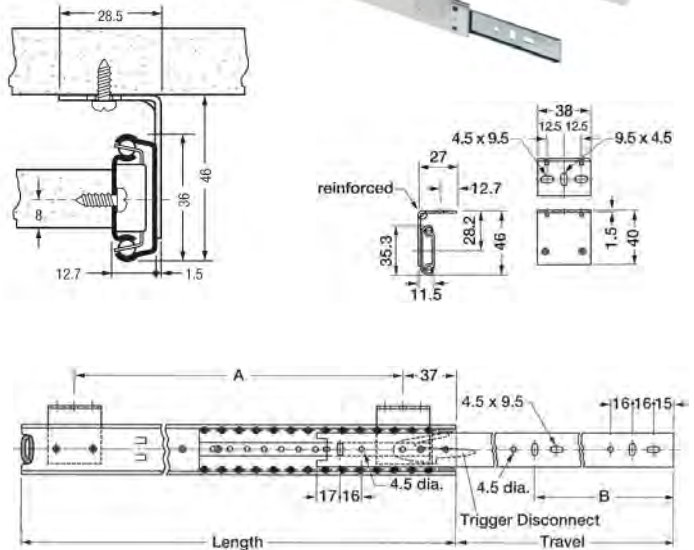

- Simple top mounting with brackets welded to the slide
- Easy to operate disconnect trigger
- Hold-close detent
- Load capacity: 75 lbs.
- Cold rolled steel with steel ball-bearings
- Zinc Plated - Anochrome finish
- Suited for pencil trays, work surface extensions and/or to add a drawer

Plastic Sleeve Pack: 20 pr. per carton. No Screws.

Code	Size	Travel	List
5162-16	16"	12"	\$ 20.91
5162-18	18"	13.5"	19.33
5162-20	20"	15"	19.77
5162-22	22"	16.5"	19.58

**Note:** has 75 lb. rating, lever disconnect and lower cost vs. 2006 45 lb. rating and friction disconnect.



## FULL EXTENSION SLIDES

### PRIDE FULL EXTENSION SLIDES

Steel Ball-bearing, Load Cap: 100 lbs.



**4903**

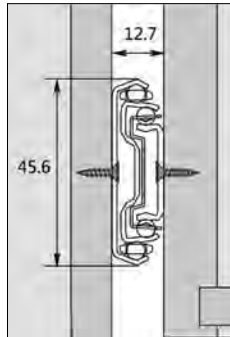

- 100 lbs. Load Capacity
- Soft Close, Soft Pull
- Full Extension, Ball-Bearing
- Zinc Plated
- Rear Bracket available



4903-BRKT



10 pr/Ctn. Bulk, No screws

Code	10"	12"	14"	16"	18"
4903-	\$ 14.45	16.75	13.70	20.46	14.36
	<u>20"</u>	<u>22"</u>	<u>24"</u>	<u>26"</u>	<u>28"</u>
	23.76	23.17	26.55	29.32	24.31

Code	Description	Ctn	List/ea
4903-BRKT	Rear Bracket	100 ea.	\$ 6.03

### KV Tru-Trac® TT100B Side Mount Slides

Full Extension, Ball Bearing



**TT100B**

KV Tru-Trac Slides offer a medium-duty, ball-bearing slide, meeting industry test standards with smooth ball-bearing operation and no-rebound.

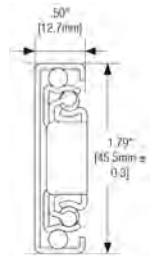

- 100 lb load rating, Zinc finish, import
- Full extension, ball bearing side mount
- 32mm hole pattern, Face Frame mounting hole
- Lever disconnect for easy drawer removal
- Recommended max drawer width: 24"
- Non-handed with a hold-in detent to prevent bounce back

### TT100B, ZINC, BULK 10pr./Ctn, No Screws \*

Code	10"	12"	14"	16"
TT100B-	\$ 10.82	11.96	13.14	14.58
	<u>18"</u>	<u>20"</u>	<u>22"</u>	
	15.85	15.96	17.25	

### KV DuriSlide™ DUR45B Side Mount Slides

Full Extension, Ball Bearing



**DUR45B**

KV DuriSlide's ball-bearing construction delivers smooth operation and a budget price.

- 100 lb load rating, Zinc finish, import
- Full ext, ball bearing side mount slides
- 32mm hole pattern, Face Frame mounting hole
- Lever disconnect
- Recommended max drawer width: 24"
- Non-handed with hold-in detent
- Lighter gauge than the TruTrac

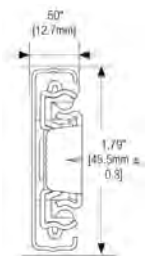

### DUR45B, ZINC, BULK 10pr./Ctn, No Screws \*

Code	12"	16"	18"
DUR45B-	\$ 10.28	12.36	13.59
	<u>20"</u>	<u>22"</u>	<u>24"</u>
	14.64	15.79	17.03

\* mm sizes are 250 - 700mm in 50mm steps



## FULL EXTENSION SLIDES



### 8400 FULL EXTENSION SLIDE

Load Capacity: 100 lbs.

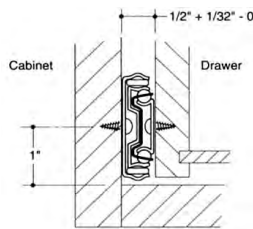

**KV 8400**

- Face Frame screw hole, no front bracket needed
- Non-handed release tabs (patented)
- Slides are degreased -  
clean and dry to handle  
Height: 1-13/16"  
Clearance: 1/2" + 1/32" - 0  
3/16" Height adjustment

The KV 8400 also features: Non-handed tab disconnect for drawer removal; 32mm hole pattern with direct access mounting; ball retainer latch and ramps for easy drawer insertion; drawer adjustment without removal; flexible mounting tabs self adjust to side clearance; polymer stop cushions; non-handed. WIC approved. Made in USA.

**15** Full Extension and Overtravel available in Anochrome finish.

### MOUNTING BRACKETS

Brackets for the KV 8400/8405 slides. Snap-in action, can be secured with screws. 2-3/4" max. adjustment. Non-handed. Overall length: 3-1/2". Anochrome.



Code	Description	Ctn	List/ea
8403	Rear Bracket	20 ea.	\$ 3.19
8404	Front Bracket	20	1.81

### 8400 Anochrome, Bulk 10pr/Ctn. No Screws

Code	8"	10"	12"	14"	16"	18"
8400B-	\$ 25.36	24.59	25.14	27.09	26.81	27.97
	<u>20"</u>	<u>22"</u>	<u>24"</u>	<u>26"</u>	<u>28"</u>	
	28.70	31.51	30.53	34.71	36.29	

### 8400 Anochrome, Polybagged, 10pr/Ctn. With Screws

Code	8"	10"	12"	14"	16"
8400P-	\$ 31.78	32.49	33.00	33.15	34.08
	<u>18"</u>	<u>20"</u>	<u>22"</u>	<u>24"</u>	
	34.90	36.96	38.71	40.33	

### 1" OVERTRAVEL - 8405

### 8405 Anochrome, Bulk 10pr/Ctn. No Screws

Code	10"	12"	14"	16"
8405B-	\$ 25.12	24.93	27.25	26.79
	<u>18"</u>	<u>20"</u>	<u>22"</u>	<u>24"</u>
	28.09	27.26	30.07	30.63



**FULL EXTENSION SLIDES**

**FULTERER 5000 FULL EXTENSION SLIDE**

Load Capacity: 100 lbs. Smooth & Quiet

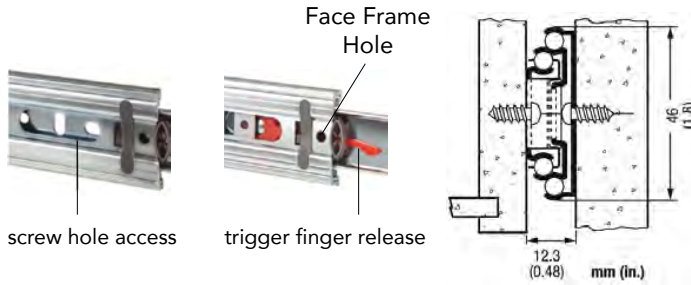

Height: 1-25/32"  
 Clearance: 1/2" + 1/32" - 0

1/2" is the actual size of the slide. Allow extra 1/32" for clearance if desired.

- Premium Build Quality
- Face Frame Screw Hole, no front bracket needed
- Trigger Finger Release
- Ball bearing retainer guide ramp; for easier insertion of drawer to slide
- Precision steel ball-bearing drawer slide, medium duty for office and residential. Cold rolled steel with Zinc Chromate finish.
- System 32 compatible hole locations
- Non-handed, and has a hold-close detent
- WIC Approved at 100 lbs.

Overtravel (1") version 5000OT available.

**REAR MOUNTING BRACKET**

Rear bracket for the Fulterer 5000, 5000OT, and 5000SC Slides.  
 Max Adjustment = 2-1/8"  
 Overall Length = 3-1/2" Non-handed. Metal.



Code	Description	Ctn	List/pr
5000MET	Rear Bracket	150 prs.	\$ 2.58

**BOTTOM MOUNT BRACKET**

Bottom mount bracket for the Fulterer 5000. Slides. 11mm Height.



Code	Description	Ctn	List/ea
5000BMB	Bottom Mount Bracket	200 ea.	\$ 1.32

**5000, ZINC, BULK 10pr./Ctn, No Screws**

Code	6"	8"	10"	12"	14"	16"
5000-	\$ 16.25	16.21	20.59	23.56	19.87	19.35
	18"	20"	22"	24"	26"	28"
	20.90	22.29	24.11	25.90	28.09	29.57

**5000B, BLACK, BULK 10pr./Ctn, No Screws**

Code	14"	16"	18"	22"
5000B-	\$ 19.56	16.97	22.11	25.33

**5000P, ZINC, Polybagged, 10pr./Ctn**

With Screws and Instructions

Code	8"	10"	12"	14"	16"	18"
5000P-	\$ 14.65	15.82	17.26	16.96	17.20	18.44
	20"	22"	24"	26"	28"	
	21.56	22.41	25.54	19.38	28.33	

**1" OVERTRAVEL - 5000OT**

**5000OT, ZINC, BULK 10pr./Ctn, No Screws**

1" Overtravel

Code	12"	14"	16"	18"
5000OT-	\$ 23.80	19.27	19.87	24.01
	20"	22"	24"	
	22.84	24.54	27.97	



## FULL EXTENSION SLIDES

### FULTERER 5045 FULL EXTENSION SLIDE

Load Capacity: 100 lbs.

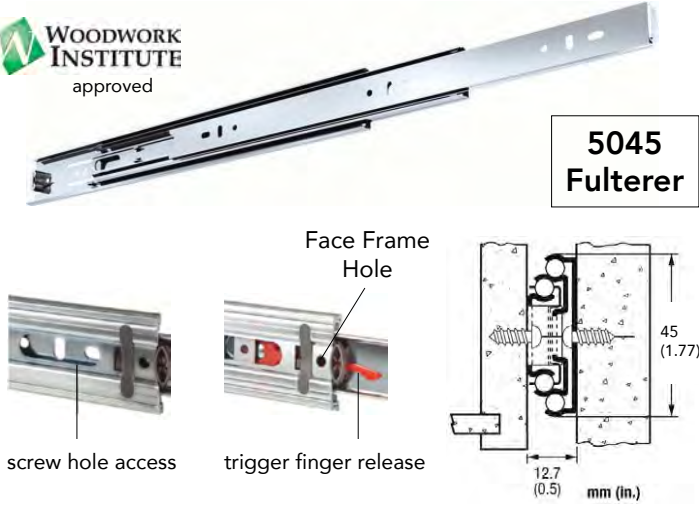

- Easy to operate disconnect finger release trigger
- System 32 compatible hole locations
- Slide is non-handed, and has a hold-close detent
- Load capacity: 100 lbs. WIC approved.

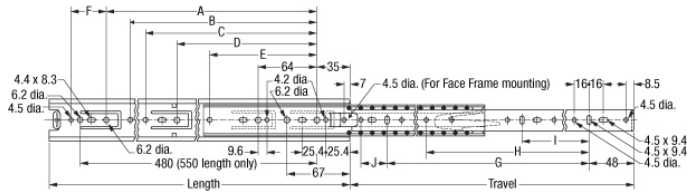

### 5045, ZINC, BULK 10pr./Ctn, No Screws

Code	10"	12"	14"	16"	18"
5045-	\$ 7.40	11.45	12.49	12.61	14.76
	20"	22"	24"	26"	
	17.16	18.67	23.46	23.58	

Code	Description	Ctn	List
5045-S	Rear Bracket	100 pr.	\$ 2.31/pr
5045BMB	Bottom Bracket	100 ea.	1.71/ea

### SUGATSUNE STAINLESS STEEL DRAWER SLIDE

Full Extension Slides

- Full extension, 304 stainless steel slide
- Hold-in detent, non-handed
- 32mm hole pattern, 37mm setback
- With face frame hole
- Mount with M4 or #8 Binding, Pan or Truss head screws

### ESR 3813 Load Cap 75 lbs. approx. Stainless Steel



- Load Cap: 98 lbs (8") to 64 lbs (24")
- Height 1.46", Side space: .48"
- \*Sizes available: 8" - 24", Pack: 10 pr.

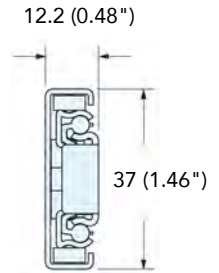

Call for Current Pricing

### ESR 4513 Load Cap 100 lbs. approx. Stainless Steel



- Load Cap: 115 lbs (10") to 87 lbs (28")
- Height 1.71", Side space: .51"
- **Stocking sizes: 20", 22"**  
 - all other sizes Special Order.  
 Call for current pricing.

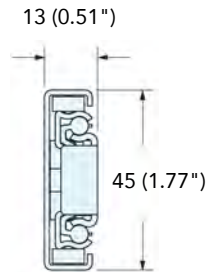

Pack: 10 pr.

Code	20"	22"
ESR4513-	\$ 51.06	56.92



## SOFT CLOSE

## FULL EXTENSION SLIDES

### FULTERER 5046ECD SOFT-CLOSE SLIDE

Full Extension, Load Capacity: 100 lbs.



**5046ECD  
Soft Close**

### 5046ECD 12" - 28"

- 1/2", Side Mount, Ball-Bearing, Zinc Plated
- 100 lb. load capacity
- Disconnect release trigger
- System 32 compatible hole locations
- Tolerance absorbing mounting tabs
- Degreased : clean to handle

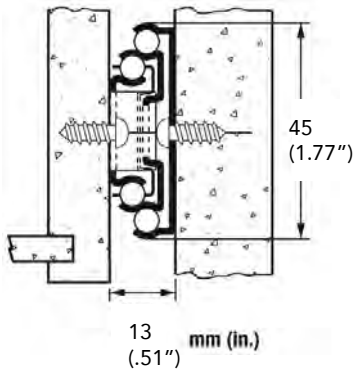

### 100 lb. Soft Close 5046 Slides

<u>Code</u>	<u>Length</u>	<u>Ctn</u>	<u>List/pr</u>
5046ECD-12	12" / 300mm	15 pr	\$ 19.03
5046ECD-14	14" / 350mm	15	21.73
5046ECD-16	16" / 400mm	15	23.93
5046ECD-18	18" / 450mm	15	26.22
5046ECD-20	20" / 500mm	15	28.39
5046ECD-22	22" / 550mm	15	30.63
5046ECD-24	24" / 600mm	15	32.88
5046ECD-26	26" / 650mm	15	35.12
5046ECD-28	28" / 700mm	15	37.37



Bottom  
Mounting  
Bracket

5045BMB



Rear  
Mounting  
Bracket

5045-S

<u>Code</u>	<u>Description</u>	<u>Ctn</u>	<u>List</u>
5045-S	Rear Bracket	100 pr.	\$ 2.31/pr
5045BMB	Bottom Bracket	100 ea.	1.71/ea

## SOFT CLOSE

### KV 8450 SOFT CLOSE SLIDE

Load Capacity: 100 lbs.

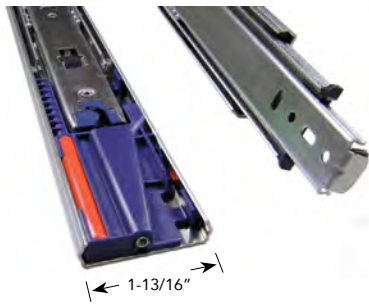

**KV8450**  
Soft Close

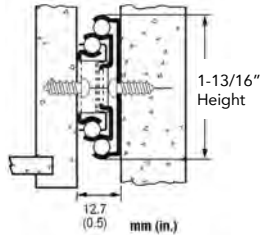

- 1/2" Side Clearance, no set-up change
- Full-Ext. 100 lb. Class rated for med-duty applications
- Non-handed design allows for easy, flexible installation in a cabinet shop
- Traditional and 32mm hole patterns allow for installation on framed and frameless cabinetry
- Three ball bearings per inch and polymer stop cushions aid with smooth quiet operation of the slide
- Push-in lever disconnect allows for easy drawer removal
- Ball retainer latch/ ramps allow for easy drawer insertion

#### Specifications

mounting	Side mounting for frame and frameless construction
clearance	1/2", plus 1/32" minus 0" each side
height	1-13/16"
action	Progressive, telescopic movement on precision steel ball bearings
accessories	8403 Rear Mounting Bracket List 3.19 /ea. Non-handed snap-on design, 2-3/4" max adjustment
	8404 Front Bracket List 1.81 /ea. Non-handed snap-on design; fits all KV8400 series products

### 8450B Anochrome, Bulk, 10pr/Ctn.

Code	12"	14"	16"	18"	20"
8450B-	\$ 40.40	39.47	39.48	43.39	40.19
	22"	24"	26"	28"	
	41.15	41.67	42.01	42.36	

### 8450P Anochrome, Polybagged, 10pr/Ctn.

Code	12"	14"	16"	18"
8450P-	\$ 50.39	50.39	50.39	50.79
	20"	22"	24"	
	51.40	51.91	52.36	

## FULL EXTENSION SLIDES

### FULTERER 5001ECD SOFT-CLOSE SLIDE

Full Extension, Load Capacity: 100 lbs.

**5001ECD**  
Soft Close

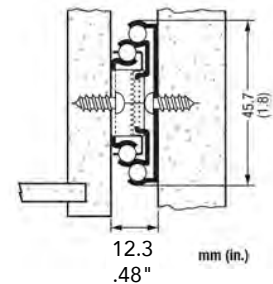
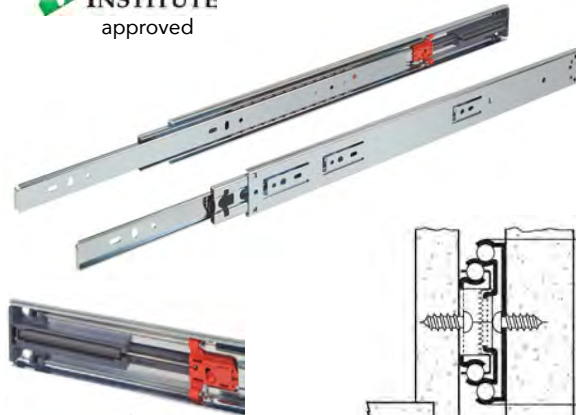

ECD mechanism provides self-closing and impact absorbing soft-close feature

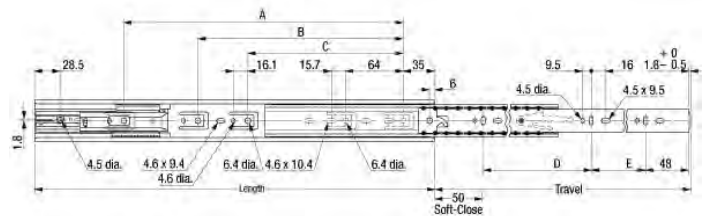

- 1/2" Side Clearance
- Soft-Close, Full-extension ball-bearing slide, Load Cap: 100 lbs. Non-handed.
- Easy to operate disconnect finger release trigger
- Ball bearing retainer guide ramp; for easier insertion of drawer to slide
- System 32 compatible hole locations
- ECD Easy Close Device mechanism provides self-closing and impact absorbing soft-close feature
- Can be used with 5000MET rear bracket and 5000BMB Bottom Mount Bracket



Bottom Mounting Bracket

5000BMB

List \$ 1.32/ea.



Rear Mounting Bracket

5000MET

List \$ 2.58/pr.

### 5001ECD Anochrome, 10pr/Ctn.

Code	12"	14"	16"	18"
5001ECD-	\$ 31.82	31.91	33.30	34.36
	20"	22"	24"	28"
	35.85	37.88	41.31	46.65

Polybag version available: 5001ECDP- 12" - 22"

## FULL EXTENSION SLIDES

### G-SLIDE - SLIDE WITH SOFT CLOSE

GS4270: Full Extension, Ball-Bearing, Load Cap: 100 lbs.

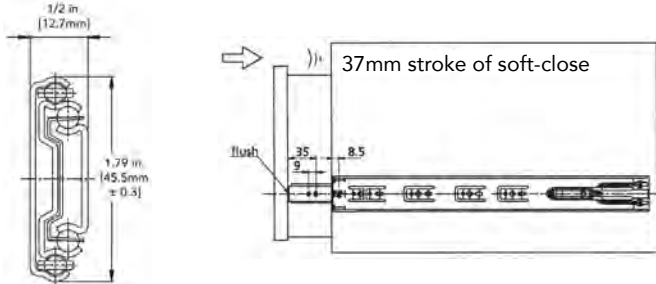

**GS4270  
Soft-Close**

**Features:**

- Soft-Close function is built-in, easy side mount installation
- 1.18" (30mm) stroke of soft-close with piston
- Non-handed disconnect release
- Electro-Zinc plated with clear chromate
- 13mm side spacing
- Screw mounting system 32mm compatible
- 6 lbs. pull force to open
- 100 lbs. Load Rating per pair at 22" length
- WIC Approved

Pack: 10 pr./box

Code	Slide Length	Slide Travel	List/pr
GS4270-12	300	8.39"	\$ 16.58
GS4270-14	350	11.93"	26.76
GS4270-16	400	15.90"	27.59
GS4270-18	450	17.91"	29.33
GS4270-20	500	19.88"	31.12
GS4270-22	550	21.85"	32.94
GS4270-24	600	23.82"	34.82
GS4270-26	650	25.79"	39.97
GS4270-28	700	27.76"	38.57

### G-SLIDE - SLIDE WITH "PUSH" OPEN FEATURE

GS4260: Full Extension, Ball-Bearing, Load Cap: 100 lbs.



Side Mount "Push" Slide

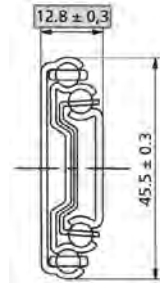

**GS4260  
PUSH**

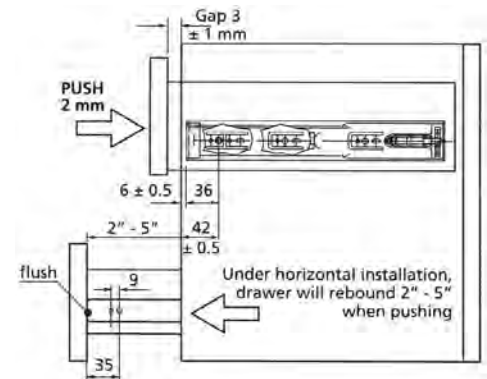

**Features:**

- Push-Rebound to open, easy side mount installation
- Rebound 2" - 5" when drawer is pushed
- Full-Extension, Ball-bearing
- Non-handed disconnect release
- Electro-Zinc plated with clear chromate.
- Only 2mm required to fully push in for opening or closing
- 9/16" (13mm) side spacing
- 100 lb. Load Rating per pair at 22" length

Pack: 10 pr./box

Code	Length	List/pr
GS4260-10	254	\$ 23.91
GS4260-12	300	25.08
GS4260-14	350	26.70
GS4260-16	400	25.33
GS4260-18	450	27.08
GS4260-20	500	30.51
GS4260-22	550	30.45
GS4260-24	600	32.16
GS4260-26	650	34.21
GS4260-28	700	35.00

## FULL EXTENSION SLIDES

### KV 6505 OVER-TRAVEL SLIDE

with Quick Disconnect Rails  
 Load Capacity: 125 lbs.



#### Rail Mount

**6505**  
**125 lbs.**

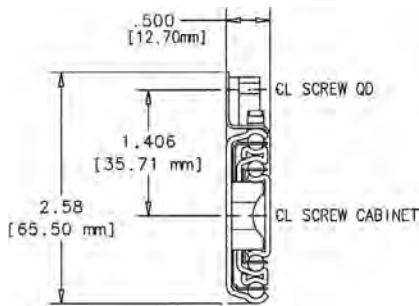

### 6505 Over-Travel Drawer Slide with QD Rail

#### Specifications

Mounting	Side Mounting
Clearance	.50"
Load Rating	125 Pound Class
Height	2.58" (includes QD Rail)
Finish	Zinc-Plated
Travel	1" Over-Travel
Action	Telescopic
Additional Features	<ul style="list-style-type: none"> <li>• 32 mm Mounting Hole Pattern</li> <li>• 1" over-travel allows for easy access to drawer contents</li> <li>• Closed position hold-in detent</li> <li>• WIC Approved</li> </ul>
Hardware	#8 x 7/16" Wood Screw with #6 Truss Head

Bulk Pack: 5pr./Ctn. No Screws

<u>Code</u>	<u>16"</u>	<u>18"</u>	<u>20"</u>	<u>22"</u>
6505B-	\$ 43.27	45.34	46.23	48.00
	<u>24"</u>	<u>26"</u>	<u>28"</u>	
	49.95	55.08	54.28	

### HETTICH 4932 FULL EXT OVERTRAVEL SLIDE

Load Capacity: 130 lbs.



Height: 2"  
 Side Space: 1/2"  
 Finish: Zinc Chromate  
 Load: 130 lbs.

**4932**  
**130 lbs.**

- Face Frame Mounting Hole
- Full Extension with 1-1/2" overtravel
- Quiet cushioned in stops and positive hold-in detent
- Lever disconnect
- Smooth action
- Strong lateral stability for wider drawers.
- WIC Approved

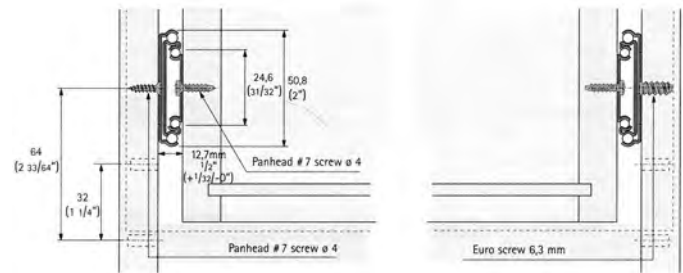

#### Assembly

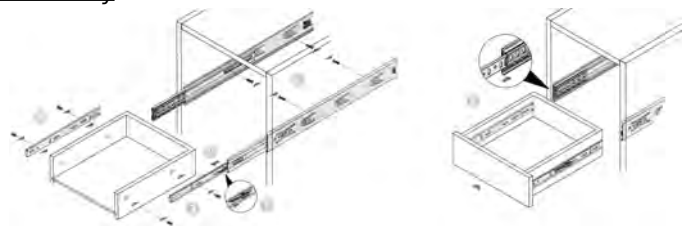

Bulk Pack: 10 pr/Ctn. with screws

<u>Code</u>	<u>12"</u>	<u>16"</u>	<u>18"</u>
4932-	\$ 26.97	24.30	22.54
	<u>20"</u>	<u>24"</u>	<u>26"</u>
	27.56	26.17	26.62



## FULL EXTENSION SLIDES

## HEAVY DUTY

### PRIDE PR5000 FULL EXT OVERTRAVEL SLIDE

Load Capacity: 150 lbs.



**PR5000**  
**150 lbs.**

- Full extension, side mounted slides
- Overtravel - 1.5"
- Lever disconnect
- Steel, Zinc finish
- 12.7mm side clearance

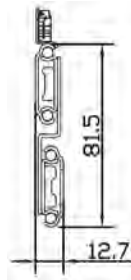

### PR5000, Zinc, OVERTRAVEL, 10pr/Ctn.

Code	16"	18"	20"	22"
PR5000-OT	\$ 33.76	38.53	42.18	46.65

### KV 8505 FILE DRAWER SLIDE

Full Extension, Progressive Action, Overtravel, Load Capacity: 150 lbs.



**8505**  
**150 lbs.**

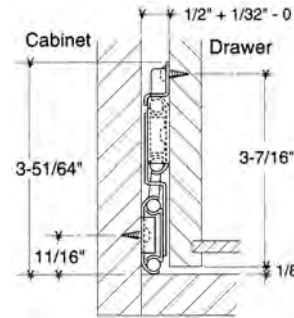

Mounting: Side  
 Height: 3-51/64"  
 Clearance: 1/2" + 1/32" - 0  
 Load Cap: 150 lbs.  
 Finish: Anochrome  
 Action: Progressive action on steel ball-bearings

32mm hole pattern for system mounting. Factory-attached drawer release clips with non-handed quick disconnect drawer members. Hold-in feature to prevent bounce back. Positive in/out stops, metal ball retainer holds 3 bearings per inch of race for smooth and quiet motion. WIC Approved. Made in USA.

8505 1-1/2" Overtravel Drawer Slide  
(max 30" drawer width)

### 8505B 1-1/2" OT, Anochrm, Bulk, 5pr/Ctn. No Screws

Code	16"	18"	20"	22"
8505B-	\$ 55.33	60.04	65.44	64.84



## HEAVY DUTY

## FULL EXTENSION SLIDES

### KV 8815 HEAVY DUTY DRAWER SLIDE

Load Capacity: 190 lbs, Overtravel: 1"



**8815**  
**190 lbs.**

Special Order  
Only

Mounting: Side  
Clearance: .75" (+.030, -.000)  
Height: 2.09"  
Finish: Zinc Plated

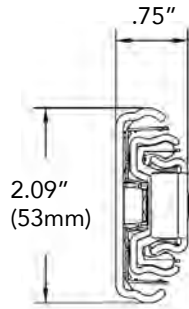

1" Overtravel. Telescopic action.

190 lb. class heavy-duty over travel drawer slide features an unhanded design and is ideal for wide drawers with heavy loads. With a side clearance of 3/4" this slide also features a butterfly lever release that allows for easy disconnect. Recommended for drawers up to 42" wide.

#### Bulk Pack 4pr./Ctn No Screws

Code	16"	18"	20"	22"
8815B-*	\$ 78	84	90	95
	<u>24"</u>	<u>26"</u>	<u>28"</u>	
	101	106	113	

### KV 8810 HEAVY DUTY DRAWER SLIDE

Load Capacity: 200 lbs, Full Extension



**8810**  
**200 lbs.**

Mounting: Side  
Clearance: .75" (+.030 - .00)  
Height: 2.09"  
Finish: Zinc Plated  
Action: Telescopic

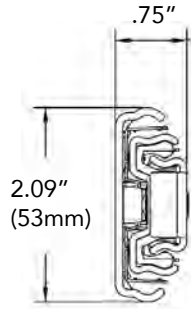

200 lb. class heavy-duty full extension drawer slide features an unhanded design and is ideal for wide drawers with heavy loads. With a side clearance of 3/4" this slide also features a butterfly lever release that allows for easy disconnect. Recommended for drawers up to 42" wide.

#### Bulk Pack 4pr./Ctn No Screws

Code	12"	*16"	*18"	20"
8810B-	\$ 58	77	70	74
	<u>22"</u>	<u>*24"</u>	<u>*26"</u>	<u>28"</u>
	78	83	87	84

## FULL EXTENSION SLIDES

## HEAVY DUTY

### FULTERER 5210 HEAVY DUTY SLIDE

200 lb. Load Capacity, Full-Extension + 1"

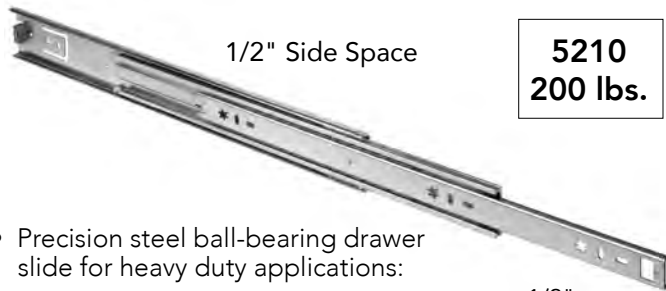

- Precision steel ball-bearing drawer slide for heavy duty applications: Residential and Commercial
- Easy to operate disconnect, finger release trigger
- System 32 compatible hole locations
- Drawer slide is non-handed and has a hold-close detent
- Full extension + 1" over-extension

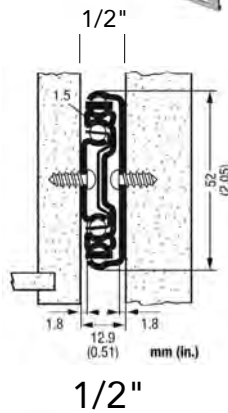

### FULTERER 5210ECD SOFT CLOSE HEAVY DUTY SLIDE

200 lb. Load Capacity, Full-Extension + 1"

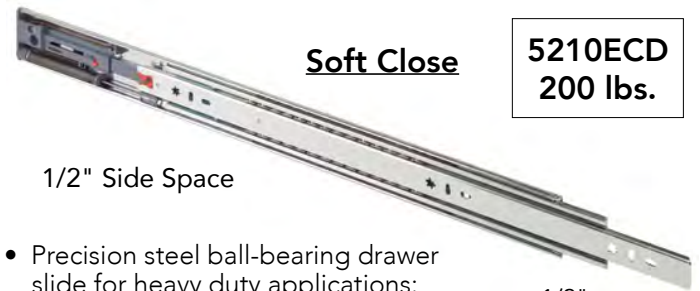

- Precision steel ball-bearing drawer slide for heavy duty applications: Residential and Commercial
- Easy to operate disconnect, finger release trigger
- System 32 compatible hole locations
- Drawer slide is non-handed and has a hold-close detent
- Full extension + 1" over-extension
- ECD Easy Close Device:

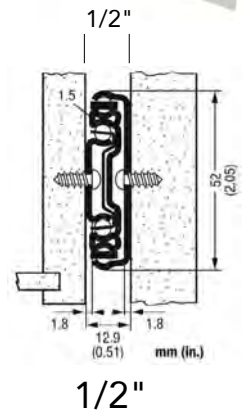

#### Soft Close / Self Close

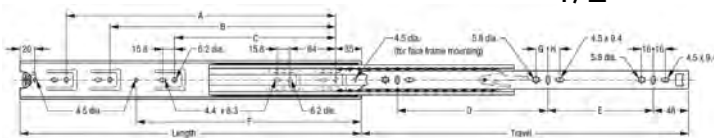

Length mm / in	Travel inches	Cabinet Profile			Drwr Profile	
		A	B	C	D	E
250 / 9.84"	9.84"	-	-	6.30"	-	6.30"
300 / 11.81"	12.80"	-	-	7.56"	-	7.56"
350 / 13.78"	14.76"	-	-	8.82"	7.56"	2.52"
400 / 15.75"	16.73"	-	11.34"	8.82"	7.56"	3.78"
450 / 17.72"	18.70"	13.86"	11.34"	8.82"	8.82"	5.04"
500 / 19.69"	20.67"	16.38"	11.34"	8.82"	11.34"	5.04"
550 / 21.65"	22.64"	16.38"	11.34"	8.82"	11.34"	6.30"
600 / 23.62"	24.61"	18.90"	11.34"	8.82"	12.60"	7.56"
650 / 25.59"	26.58"	21.42"	11.34"	8.82"	12.60"	7.56"
700 / 27.56"	28.54"	22.68"	11.34"	8.82"	15.12"	8.82"

11" through 18": 10 pr/ box. 20" and 22": 8 pr/ box.  
 24" through 28": 6 pr/box.

Code	11"	12"	14"	16"	18"
5210-	\$ 25.81	31.69	36.91	38.82	42.07
	20"	22"	24"	26"	28"
	45.74	50.04	55.84	57.35	67.91

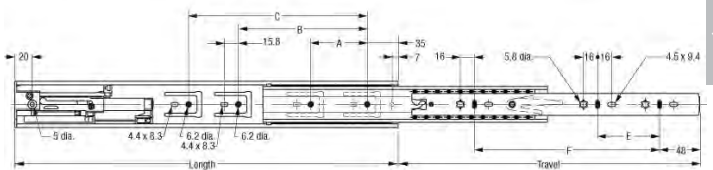
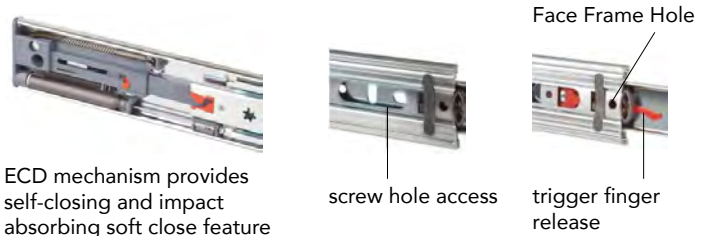

16" and 18": 10 pr/ box. 20" and 22": 8 pr/ box.  
 24" and 26": 6 pr/box.

Code	Size	Travel	List/pr
5210ECD-16	16"	16.73"	\$ 64.42
5210ECD-18	18"	18.70"	66.79
5210ECD-20	20"	20.69"	67.45
5210ECD-22	22"	22.64"	70.91
5210ECD-24	24"	24.61"	79.34
5210ECD-26	26"	26.6"	83.41





## HEAVY DUTY

### PRIDE 5890 FULL EXT HEAVY DUTY SLIDE

Load Capacity: 250 lbs.



- Full ext, ball-bearing slides
- 3/4" (19mm) side clearance
- Load cap: 250 lbs
- Lever disconnect
- Zinc finish,  
Cold rolled steel material

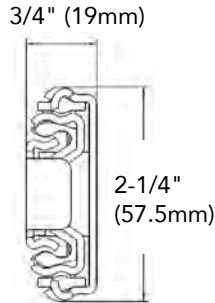

Pack: 5 pr/Ctn.

<u>Code</u>	<u>Slide Length</u>	<u>Travel Length</u>	<u>List/pr</u>
5890-32	32"	32.75"	\$ 133.42

## FULL EXTENSION SLIDES

### FULTERER 5400 HEAVY DUTY SIDE MOUNT SLIDES

Load Capacity: 550 lbs.



**EXTRA  
HEAVY DUTY  
Fulterer 5400  
550 lbs.**

**Side Mounted**  
Extra Heavy Duty  
Full Extension Slide.

Load Capacity: 550 lbs/pr.  
Slide Width: .77" (19.5mm)  
Slide Height: 3" (76.2mm)  
Steel, zinc-plated.

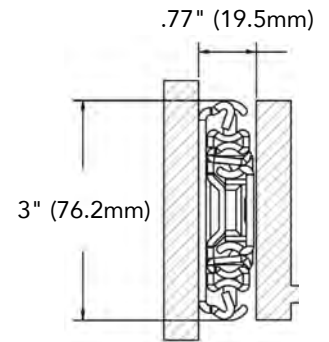

Slide is non-handed, i.e. either unit can be mounted to either side. Stainless Steel ball bearings. Dynamic up to 550 lbs (250 kg). Slides are non-detachable. Flat mounting possible, weight capacity reduced.

<u>Code</u>	<u>Size</u>	<u>Ctn</u>	<u>List/pr</u>
5400-14	14" (356mm)	4 pr	\$ 100.00
5400-16	16" (406mm)	4	115.00
5400-18	18" (457mm)	4	129.00
5400-20	20" (508mm)	4	129.80
5400-22	22" (559mm)	4	159.00
5400-24	24" (610mm)	4	161.29
5400-26	26" (660mm)	2	173.62
5400-28	28" (711mm)	2	187.04
5400-30	30" (762mm)	2	200.48
5400-32	32" (813mm)	2	217.80
5400-34	34" (863mm)	2	224.09
5400-36	36" (914mm)	4	255.00
5400-40	40" (1016mm)	4	283.01
5400-42	42" (1067mm)	4	305.00
5400-48	48" (1219mm)	2	345.00
5400-50	50" (1270mm)	2	372.00
5400-60	60" (1524mm)	2	450.00

**Brackets for 5400 Slides**  
Available Special Order



**Lockout version of 5400 Slides**  
Available Special Order



12" to 60" Lengths



## EURO SLIDES

### SALICE A208 WHITE EURO SLIDES

Bottom Mount, Self-Closing, 3/4 Extension



**A208**

Load Capacity:  
75 lbs. Dynamic

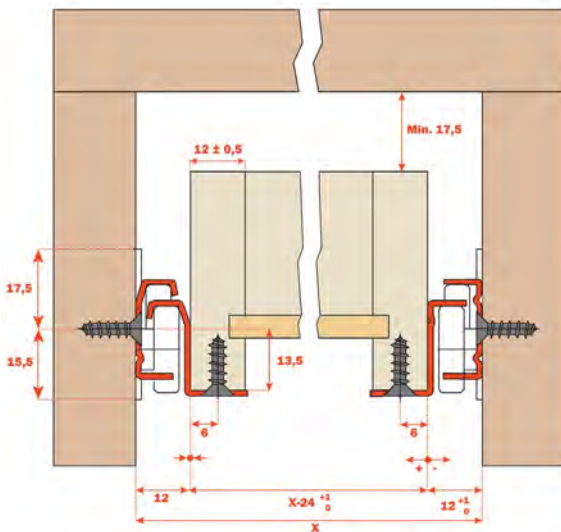

- Left sided captive (by pressure sliding) to ensure smooth opening and closing
- Rise of 1.2mm in first 20mm (3/4") of extension
- Dynamic Load capacity of 75 lbs.
- Double safety stop to prevent accidental pull-out of the drawer
- Automatic closing during last 60mm (2.4")
- Rear socket available

Pack: 25 pr/box

Code	10"	12"	14"	16"
A208-	\$ 6.07	5.70	5.92	6.45
	18"	20"	22"	
	6.39	6.82	7.50	



**Rear Sockets:** List \$ 1.00 /ea  
 A208-SL Left Hand  
 A208-SR Right Hand

### FULTERER FR1921 WHITE EUROSLIDE

Bottom Mount, Self-Closing, Load Capacity: 75 lbs

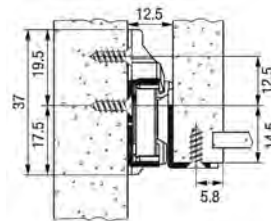

**FR1921**  
**White**  
**75 lbs.**

Material: White powder coated cold rolled steel  
 Bearings: Nylon  
 Load Cap: 75 lbs Dynamic  
 Mounting: Bottom, 1/2" clearance  
 Extension: 3/4 Extension

This economical slide has good running qualities through precision nylon rollers and smooth epoxy coating. Cabinet profile specially formed to prevent rollers from touching protruding screws. Long self-closing ramp on all four profiles assures perpendicular closing action.

WIC Approved.

Pack: 20 pr/Ctn.

Code	Length	Ext Loss	List/pr
FR1921-16	16" /400	80mm	\$ 3.69
FR1921-18	18" /450	90mm	5.83
FR1921-20	20" /500	100mm	6.22
FR1921-22	22" /550	105mm	6.79
FR1921-24	24" /600	120mm	6.10

## EURO SLIDES

### KV 1805 EURO-STYLE DRAWER SLIDES

Load Capacity: 75 lbs.



**KV1805**  
**White**  
**75 lbs.**

**Key Features:**

- 32mm mounting hole pattern
- Lift out disconnect
- Self close design
- Can be used with 248 / 248ABS / 217 sockets
- 3/4 extension

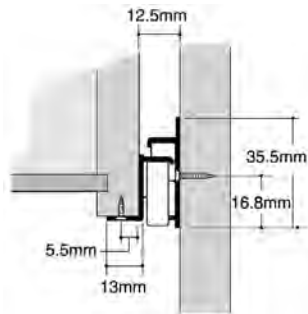

Mounting: Side 1/2"  
 Action: Nylon Rollers  
 Load Rating: 75 lb. class  
 Height: 35.5mm  
 Clearance: 12.5mm (1/2") plus .8mm (1/32"),  
 minus 0" each side  
 Finish: White (WH) Powder coat

Pack: 100 pr/box. Sold in Full Cartons Only.

White	Size	List/pr
1805Q-20	20"	\$ 6.33
1805Q-22	22"	7.52

### GRASS 5300 FULL EXTENSION EPOXY SLIDE

Load Cap: 125 lbs. Dynamic



**WOODWORK INSTITUTE**  
 approved **125 lbs.**



**5300**  
**White**

- Full Extension
- Self-Closing
- Bottom Mount
- Load Capacity: 125 lbs. (ANSI/BIFMA Grade 1)
- Side Clearance: 1/2"
- Epoxy White Finish
- Special rail profile

System 32 compatible. Also usable on existing boring patterns for single extension runners. WIC Approved.

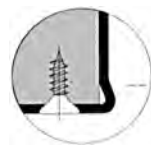
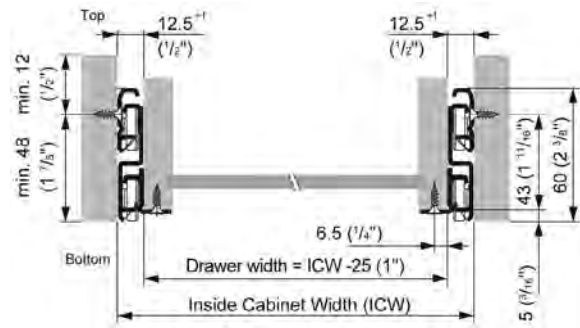

Chamfering of drawer bottoms and shelves not necessary - important time saving feature.

Pack: 10 pr/Ctn.

Code	12"	14"	16"
5300-	\$ 42.88	36.94	39.35
	18"	20"	22"
	40.73	43.26	36.14

## ZBOX SYSTEM

### G\*GRASS ZBox Drawer System



The combined strength of the ball bearing slides with the Zargen's steel construction offers a drawer solution that saves time and money with its quick drawer box construction and simple assembly.

- Integrated side mount ball bearing drawer slide and metal drawer side
- Ball bearing, telescopic, full extension
- Hold-in detent ensures drawers stay closed
- Easy lever disconnect for removal of drawer box from cabinet member
- Drawer side – white epoxy finish; Drawer slide - zinc coated steel
- Load capacity: 100 lb dynamic, 100 lb static
- Adjustments: Cam Height  $\pm 2\text{mm}$ , Side  $\pm 1.5\text{mm}$
- Zargen is made in the USA, ZBox is assembled in the USA

### 6023 Drawer Slide/Side - 3-3/8" (85mm) Side Height



Drawer Length	Bottom Panel Length		Extension
	16mm (5/8") Back Panel	19mm (3/4") Back Panel	
350 (13 3/4")	331 (13 1/16")	328 (12 15/16")	350 (13 3/4")
400 (15 3/4")	381 (15")	378 (14 7/8")	400 (15 3/4")
470 (18 1/2")	451 (17 3/4")	448 (17 5/8")	450 (17 3/4")
510 (20 1/16")	491 (19 5/16")	488 (19 3/16")	500 (19 11/16")
550 (21 5/8")	531 (20 7/8")	528 (20 13/16")	550 (21 5/8")

Side Height: 3-3/8" (85mm)

Code	Height x Length	Ctn	List/pr
6023-350	3-3/8" x 13-3/4"	5 pr	\$ 39.53
6023-400	3-3/8" x 15-3/4"	5	35.26
6023-470	3-3/8" x 18-1/2"	5	34.00
6023-510	3-3/8" x 20-1/16"	5	37.11
6023-550	3-3/8" x 21-5/8"	5	33.54

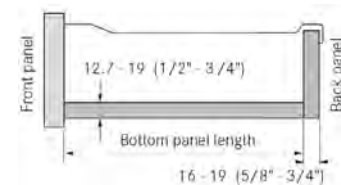

### Drawer Back and Bottom Measurements

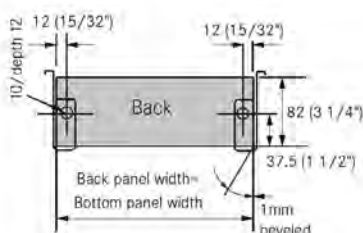
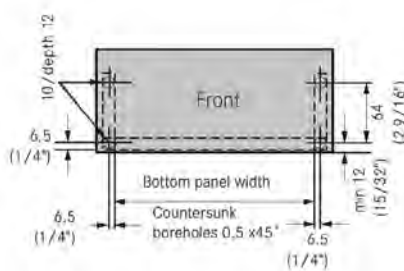

### Drawer Installation Measurements

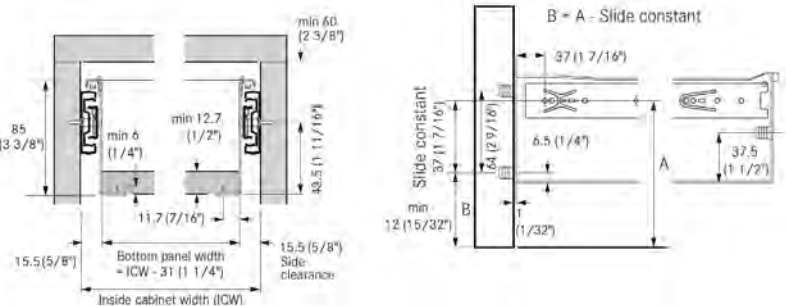

### Adjustment Features

- ① Height Adjustment: Loosen screws 2 slightly. Adjust screw 1 (adjustment  $\pm 2\text{mm}$ ). Tighten screws 2.
- ② Side Adjustment: Loosen screws 2 slightly. Adjust front to required position (adjustment range  $\pm 1.5\text{mm}$ ). Tighten screws 2.



**ZBOX SYSTEM**

**G\*GRASS** ZBox Drawer System *continued*

**6223 Drawer Slide/Side - 5-7/8" (149mm) Side Height**



Drawer Length	Bottom Panel Length		Extension
	16mm (5/8") Back Panel	19mm (3/4") Back Panel	
350 (13 3/4")	331 (13 1/16")	328 (12 15/16")	350 (13 3/4")
400 (15 3/4")	381 (15")	378 (14 7/8")	400 (15 3/4")
470 (18 1/2")	451 (17 3/4")	448 (17 5/8")	450 (17 3/4")
510 (20 1/16")	491 (19 5/16")	488 (19 3/16")	500 (19 11/16")
550 (21 5/8")	531 (20 7/8")	528 (20 13/16")	550 (21 5/8")

Side Height: 5-7/8" (149mm)

Code	Height x Length	Ctn	List/pr
6223-350	5-7/8" x 13-3/4"	5 pr	\$ 44.64
6223-400	5-7/8" x 15-3/4"	5	45.21
6223-470	5-7/8" x 18-1/2"	5	49.85
6223-510	5-7/8" x 20-1/16"	5	50.41
6223-550	5-7/8" x 21-5/8"	5	68.12

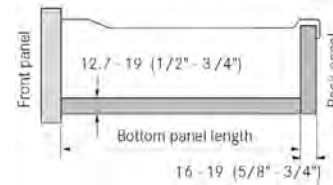

**Drawer Back and Bottom Measurements**

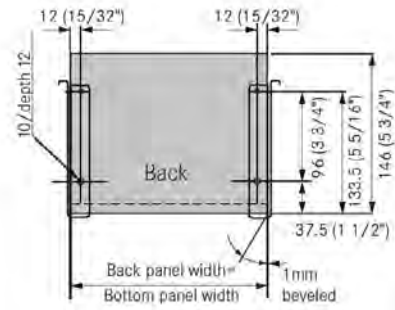
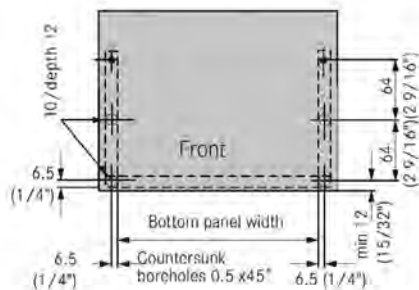

**15 Drawer Installation Measurements**

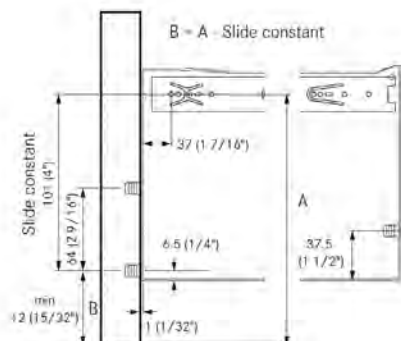
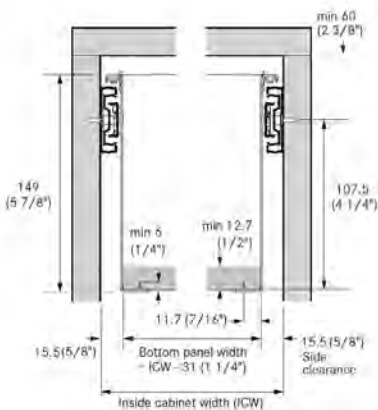

**Adjustment Features**

- 1 Height Adjustment: Loosen screws 2 slightly. Adjust screw 1 (adjustment ±2mm). Tighten screws 2.
- 2 Side Adjustment: Loosen screws 2 slightly. Adjust front to required position (adjustment range ±1.5mm). Tighten screws 2.

After adjusting front panel, mount fixing screw.



## ZBOX SYSTEM

### G\*GRASS ZBox Drawer System *continued*

#### 6423 Drawer Slide/Side - 8-3/8" (149mm) Side Height



Drawer Length	Bottom Panel Length		Extension
	16mm (5/8") Back Panel	19mm (3/4") Back Panel	
350 (13 3/4")	331 (13 1/16")	328 (12 15/16")	350 (13 3/4")
400 (15 3/4")	381 (15")	378 (14 7/8")	400 (15 3/4")
470 (18 1/2")	451 (17 3/4")	448 (17 5/8")	450 (17 3/4")
510 (20 1/16")	491 (19 5/16")	488 (19 3/16")	500 (19 11/16")
550 (21 5/8")	531 (20 7/8")	528 (20 13/16")	550 (21 5/8")

Side Height: 8-3/8" (213mm)

Code	Height x Length	Ctn	List/pr
6423-350*	8-3/8" x 13-3/4"	5 pr	*
6423-400*	8-3/8" x 15-3/4"	5	*
6423-470*	8-3/8" x 18-1/2"	5	*
6423-510	8-3/8" x 20-1/16"	5	\$ 77.08
6423-550	8-3/8" x 21-5/8"	5	75.91

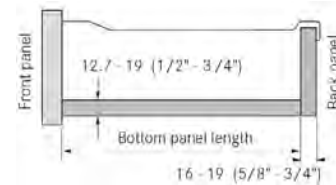

#### Drawer Back and Bottom Measurements

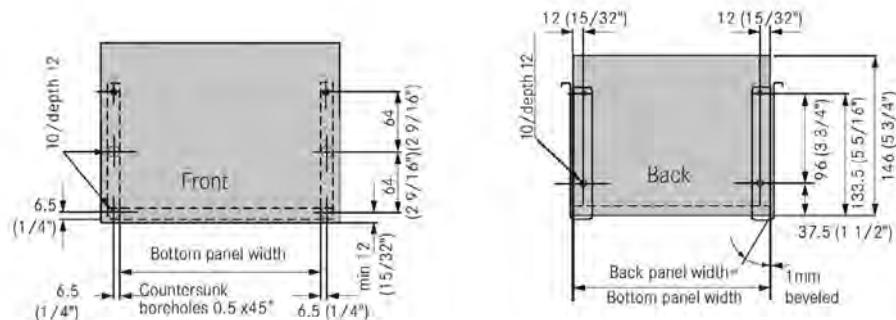

#### Drawer Installation Measurements

#### Adjustment Features

- ① Height Adjustment: Loosen screws 2 slightly. Adjust screw 1 (adjustment ±2mm). Tighten screws 2.
- ② Side Adjustment: Loosen screws 2 slightly. Adjust front to required position (adjustment range ±1.5mm). Tighten screws 2.

After adjusting front panel, mount fixing screw.

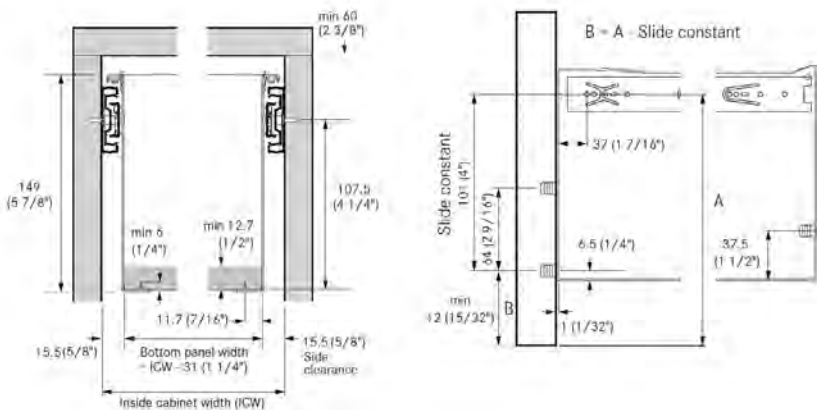

# ZBOX SYSTEM

## G\*GRASS ZBox Drawer System *continued*

## Technical Information

### Cabinet Boring Specifications

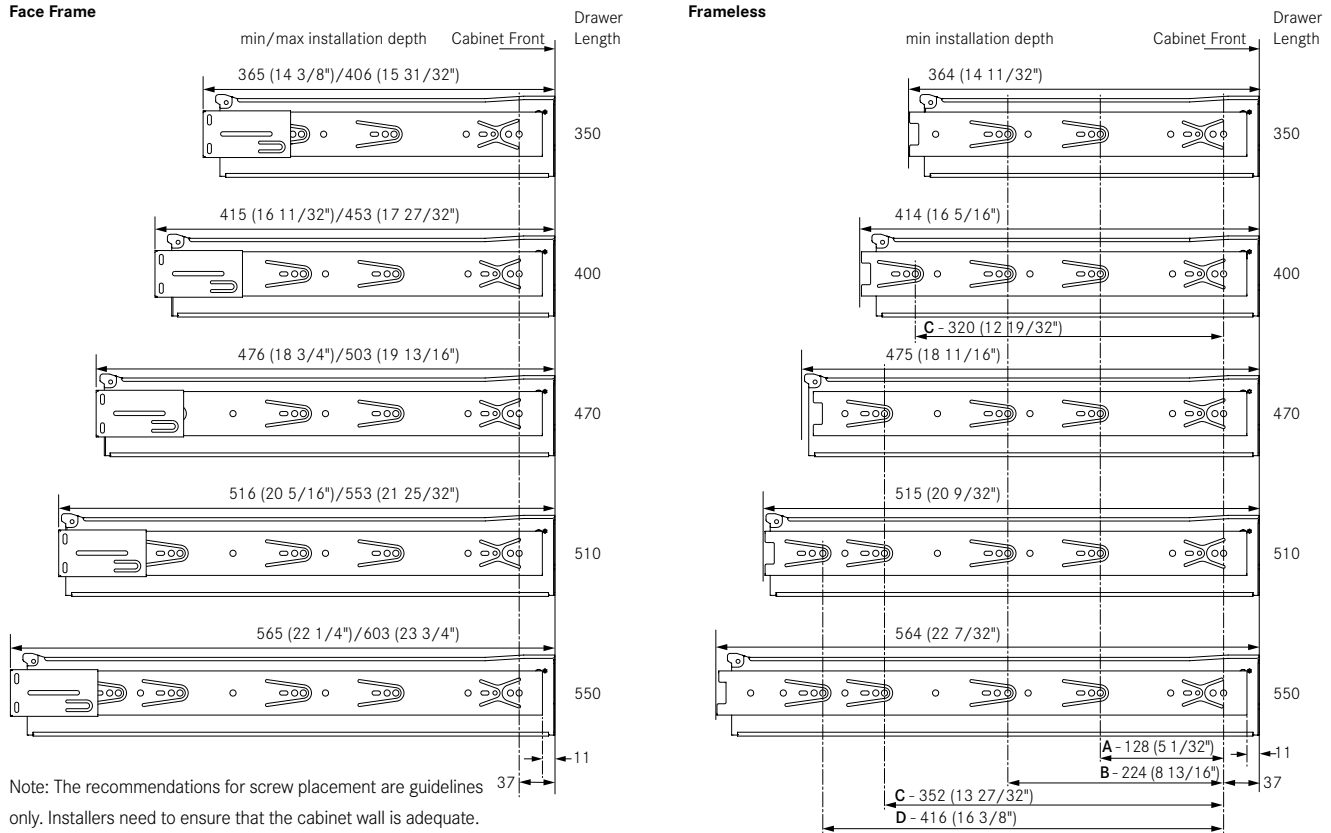

Drawer Length	Slide Travel	Screw Hole Locations				Face Frame		Frameless
		A	B	C	D	Min	Max	Min
350 (13 3/4")	350	128	224	-	-	365 (14 3/8")	406 (15 31/32")	364 (14 11/32")
400 (15 3/4")	400	128	224	320	-	415 (16 11/32")	453 (17 27/32")	414 (16 5/16")
470 (18 1/2")	450	128	224	352	-	476 (18 3/4")	503 (19 13/16")	475 (18 11/16")
510 (20 1/16")	500	128	224	352	416	516 (20 5/16")	553 (21 25/32")	515 (20 9/32")
550 (21 5/8")	550	128	224	352	416	565 (22 1/4")	603 (23 3/4")	564 (22 7/32")

### Removing the Drawer



Pull out drawer to expose the release lever mechanism

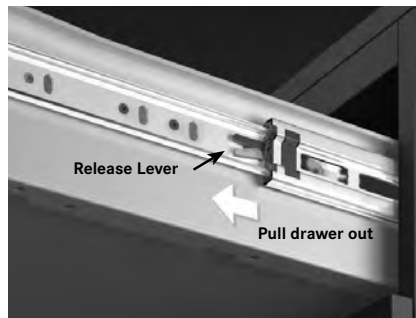

Easy Release Lever:  
 Right Side - push up; Left Side - push down  
 Pull out the drawer



Remove drawer



## VIONARO SYSTEM

### G\*GRASS Vionaro Drawer System



shown in silver grey

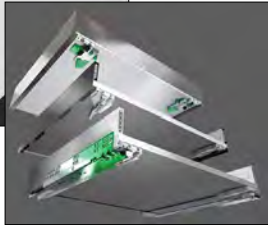

- Uses DynaPro 3D undermount slides - Load Cap: 100 lbs.
- Slim, 1/2" side width, 90° straight corners and sides
- Built-in height and side adjustment, tilt adjustment at back
- Tool free assembly
- Maximum 48" drawer width
- For frame and frameless cabinetry
- Silver grey or Graphite finish
- Avail. in 3-1/2", 4-3/4", 7-1/4" and 9-13/16" side heights

Front of Side Panel

Rear of Side Panel

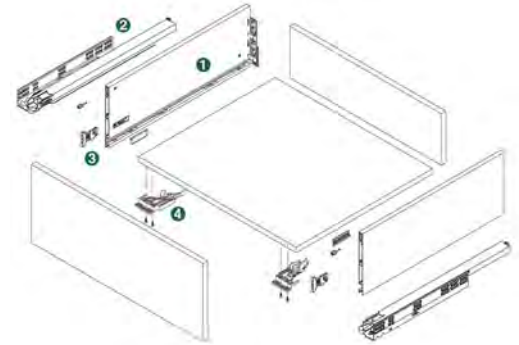
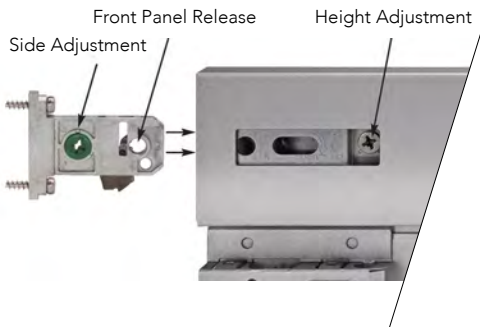

Key

1. Drawer Sides (Left/Right - 7-1/4" Ht. shown)
2. DynaPro Slides (2-D)
3. Adapter Set: Front Adapters (2x)  
Cover Caps (2x)  
Front stabilizers (2x - for V185)
4. Front Clips with flange

#### How to order

Order 1 Side Set (includes LH/RH), DynaPro Slides, Adapter Set and Front Clips separately (next page).

#### Vionaro Drawer Side Sets

10 sets/ Carton

##### 3-1/2" side height

Code	Finish	Length	List/st
V89-21S	Silver	21"	\$ 70.03
V89-15G	Graphite	15"	68.07
V89-18G	Graphite	18"	69.30
V89-21G	Graphite	21"	53.53

##### 4-3/4" side height

V121-15G	Graphite	15"	\$ 74.38
V121-18G	Graphite	18"	89.96
V121-21G	Graphite	21"	98.33

##### 7-1/4" side height

Code	Finish	Length	List/st
V185-21S	Silver	21"	\$ 116.37
V185-15G	Graphite	15"	101.17
V185-18G	Graphite	18"	99.95
V185-21G	Graphite	21"	79.66

##### 9-13/16" side height

V249-21S	Silver	21"	\$ 224.91
V249-15G	Graphite	15"	177.94
V249-18G	Graphite	18"	193.28
V249-21G	Graphite	21"	152.08

Continued on next page







**Vionaro Drawer System** - Required components continued



**Adapter Sets**, 50 sets/Ctn.

	V89-AS		V185-AS
<u>Code</u>	<b>For 3-1/2" &amp; 4-3/4" Hts</b>	<u>Finish</u>	<u>List/st</u>
V89-AS	Includes Front adapters, Cover Caps	Silver	\$ 11.89
V89-AG	Includes Front adapters, Cover Caps	Graphite	8.40
<u>Code</u>	<b>For 7-1/4" &amp; 9-13/16" Hts</b>	<u>Finish</u>	<u>List/st</u>
V185-AS	Includes Front adapters, Cover Caps, Front stabilizers	Silver	\$ 13.14
V185-AG	Includes Front adapters, Cover Caps, Front stabilizers	Graphite	13.14

**DynaPro Slides** - 5 prs/Ctn  
For metal or wood drawers



<u>Code</u>	<u>Load Cap.</u>	<u>Length</u>	<u>List/pr</u>
DP-15-3D	100 lbs.	15"	\$ 54.36
DP-18-3D	100 lbs.	18"	52.12
DP-21-3D	100 lbs.	21"	53.72

**Front Clips with Flange**

1 LH/RH clip per set.



<u>Code</u>	<u>Ctn</u>	<u>List/st</u>
DP-V	5	\$ 4.01

**3D Rear Adapter Set**

1 LH/RH adapter per set.  
Required for 3D slides.



<u>Code</u>	<u>Ctn</u>	<u>List/ea</u>
00199-03	5	\$ 5.46

**Vionaro Drawer System** - Accessories

**For Inset Drawers**

50 Sets/Ctn.



**Accessory Set**

Consists of:

- 2 ea. Cover caps
- 1 st. Front locking devices (L/R)
- 2 ea. Front connectors
- 4 ea. Special screws
- 1 ea. Front Bottom connector
- 2 ea. End caps

<u>Code</u>	<u>Finish</u>	<u>Side Height</u>	<u>List/st</u>
V89-IAS	Silver	3-1/2"	\$ 25.47
V89-IAG	Graphite	3-1/2"	37.41
V185-IAS	Silver	7-1/4"	32.06
V185-IAG	Graphite	7-1/4"	40.66

**Inset Front Panel** 10 ea/Ctn.

45-11/16" (1160mm), cut to size



<u>Code</u>	<u>Finish</u>	<u>Side Height</u>	<u>List/st</u>
V89-IPS	Silver	3-1/2"	\$ 67.60
V89-IPG	Graphite	3-1/2"	81.73
V185-IPS	Silver	7-1/4"	102.85
V185-IPG	Graphite	7-1/4"	137.67

**Cross Divider Rails / Holders**

- Cross-divider for all Vionaro drawers
- Simple installation by mounting on the drawer side
- Tool-free adjustment

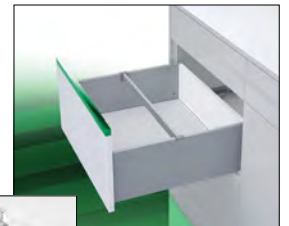

44-1/4" (1124mm), cut to size.

<u>Code</u>	<u>Description</u>	<u>Finish</u>	<u>List</u>
V-CDS*	Cross Divider Rail	Silver	*
V-CDG*	" " " "	Graphite	*
V-HS*	Holders for Divider Rail	Silver	*
V-HG*	" " " "	Graphite	*

\*Special Order - Call for Price

Continued on next page



## VIONARO SYSTEM

### Vionaro Drawer System - Accessories cont.

#### Front Marking Jig



- 2 marking jigs for both 3-1/2" and 7-1/4" heights

Code	List/st
V-FMJ	\$ 38.76

#### Depth Adjuster

- Gives +4.5mm forward adjustment



Snaps onto slide

Code	List/pr
DP-I	\$ 6.78

#### Removing the Drawer Front

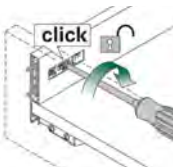

Use a poizdrive screwdriver to release drawer front, and for all adjustments

#### Drawer Measurements

#### 7-1/4" side height

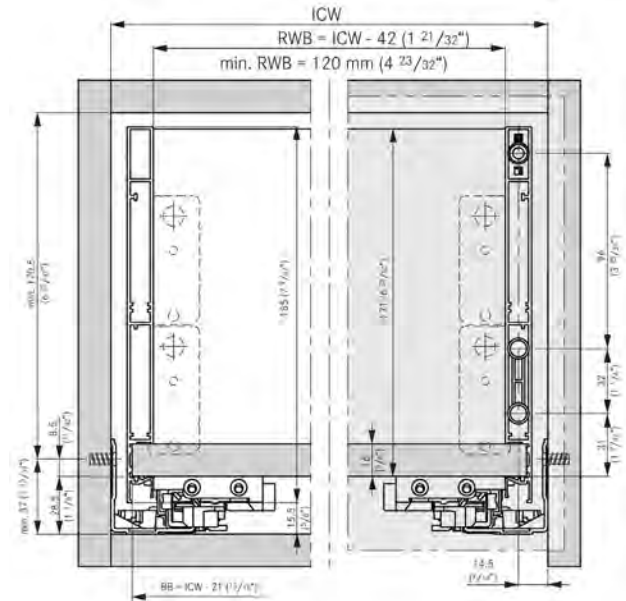
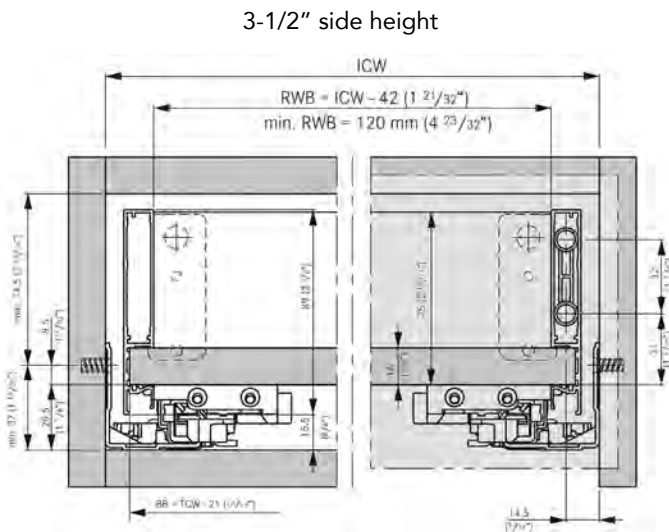



# LINEABOX

# SALICE

Special Order Only  
Call for Quote



## Lineabox 2-Sided Metal Drawers

- Use with any brand undermount slides! 21", 18", 15", 12" (Salice, Hettich, Grass, Pride, etc.)
- 5/8" front, bottom, and back supplied by shop
- No extra rips on bottom (unlike Blum Legrabox)
- Good and available alternative to Legrabox - ships from LA
- Non-handed aluminum sides notched front and back
- Available in White, Gray, and Stainless Steel

Lineabox

Packed 12 pcs/Ctn.

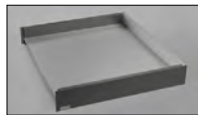

Side Profile Ht 2-15/16" (75mm)	White	Gray	Stainless Steel
Slide length 9" (229mm)	AMUBXD10229GP	AMUBXDG0229GP	AMUBXDS0229GP
Slide length 12" (305mm)	AMUBXD10305GP	AMUBXDG0305GP	AMUBXDS0305GP
Slide length 15" (381mm)	AMUBXD10381GP	AMUBXDG0381GP	AMUBXDS0381GP
Slide length 18" (457mm)	AMUBXD10457GP	AMUBXDG0457GP	AMUBXDS0457GP
Slide length 21" (533mm)	AMUBXD10533GP	AMUBXDG0533GP	AMUBXDS0533GP

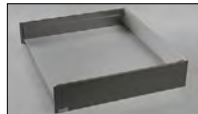

Side Profile Ht 4" (101mm)	White	Gray	Stainless Steel
Slide length 9" (229mm)	AMUMXD10229GP	AMUMXDG0229GP	AMUMXDS0229GP
Slide length 12" (305mm)	AMUMXD10305GP	AMUMXDG0305GP	AMUMXDS0305GP
Slide length 15" (381mm)	AMUMXD10381GP	AMUMXDG0381GP	AMUMXDS0381GP
Slide length 18" (457mm)	AMUMXD10457GP	AMUMXDG0457GP	AMUMXDS0457GP
Slide length 21" (533mm)	AMUMXD10533GP	AMUMXDG0533GP	AMUMXDS0533GP



Side Profile Ht 7" (178mm)	White	Gray	Stainless Steel
Slide length 9" (229mm)	AMUAXD10229GP	AMUAXDG0229GP	AMUAXDS0229GP
Slide length 12" (305mm)	AMUAXD10305GP	AMUAXDG0305GP	AMUAXDS0305GP
Slide length 15" (381mm)	AMUAXD10381GP	AMUAXDG0381GP	AMUAXDS0381GP
Slide length 18" (457mm)	AMUAXD10457GP	AMUAXDG0457GP	AMUAXDS0457GP
Slide length 21" (533mm)	AMUAXD10533GP	AMUAXDG0533GP	AMUAXDS0533GP



Side Profile Ht 9-5/16" (237mm)	White	Gray	Stainless Steel
Slide length 9" (229mm)	AMUHXD10229GP	AMUHXDG0229GP	AMUHXDS0229GP
Slide length 12" (305mm)	AMUHXD10305GP	AMUHXDG0305GP	AMUHXDS0305GP
Slide length 15" (381mm)	AMUHXD10381GP	AMUHXDG0381GP	AMUHXDS0381GP
Slide length 18" (457mm)	AMUHXD10457GP	AMUHXDG0457GP	AMUHXDS0457GP
Slide length 21" (533mm)	AMUHXD10533GP	AMUHXDG0533GP	AMUHXDS0533GP

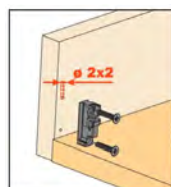

**ASMGP12A3XA** 200 each/Ctn.

Fixing Clip for Wood front and back  
Screw attachment: Ø3.5mm x 20mm included.  
(can use #6 x 3/4" as a replacement)



# GRASS ZARGEN



## GRASS ZARGEN DRAWER SYSTEM



- Load Capacity: 100 lbs.
- 3/4 Extension, Self-Closing
- Integrated drawer side and slide reduce production process
- 60mm (2-5/8") Self-Closing action and dual captive rollers
- Includes built-in drawer front adjustment and drawer front bumpers
- Dowelled for rapid assembly
- White baked-on epoxy finish
- Silent Glide roller ensures smooth, quiet ride
- WIC Approved

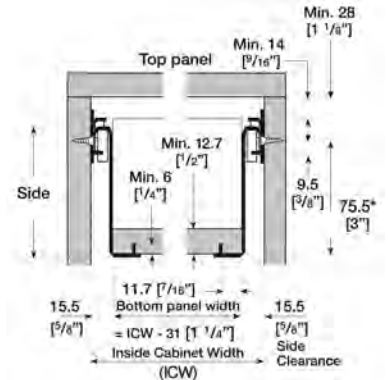

### Integrated Drawer Slide/Side, White Epoxy Finish

Side Height: 3-3/8" (85mm)

Code	Height x Length	Ctn	List/pr
6036-270	3-3/8" x 10-5/8"	10 pr	\$ 24.79
6036-350	3-3/8" x 13-3/4"	10	32.38
6036-400	3-3/8" x 15-3/4"	10	27.68
6036-470	3-3/8" x 18-1/2"	10	27.05
6036-510	3-3/8" x 20-1/16"	10	27.87
6036-550	3-3/8" x 21-5/8"	10	30.31

Side Height: 5-7/8" (149mm)

Code	Height x Length	Ctn	List/pr
6236-550	5-7/8" x 21-5/8"	5 pr	\$ 46.47

Side Height: 8-3/8" (213mm)

Code	Height x Length	Ctn	List/pr
6436-350	8-3/8" x 13-3/4"	5 pr	\$ 59.32
6436-550	8-3/8" x 21-5/8"	5	57.63

Cabinet member fastening positions

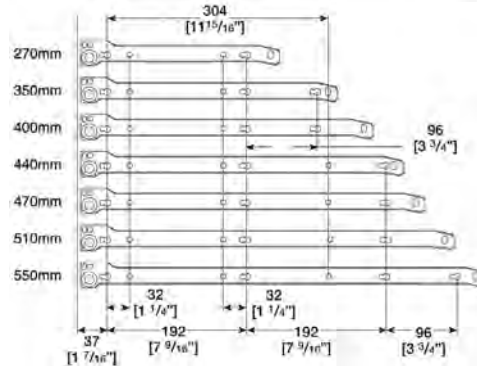

### Tech Specifications

- Self-Closing: 60mm (2-5/8")
- Side Clearance: 15.5mm (5/8")
- Tolerance Adjustment: 2mm
- Cabinet Member Screws: #6 x 5/8" FHP Wood Screws
- Euro Screws Length: 18mm, 13mm, 7.5mm
- Bottom Panel Thickness: 10mm - 16mm (6035)
- Bottom Panel Thickness: 12.7mm - 19mm (6036, 6136, 6236, 6436)
- Back Panel Thickness: 16mm - 19mm

### GRASS 6036 ACCESSORIES

6 Screws and 6 Dowels per bag.

Code	Description	Ctn	List/bg
12768	6036 Dowel & Screw Set	50 bags	\$ 1.26

## GRASS ZARGEN

### ADAPTER BRACKET

Bottom or Top Mount

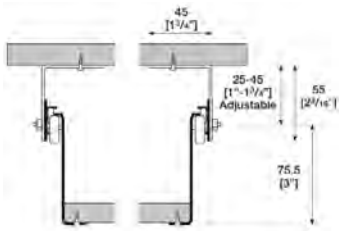

Top Mount

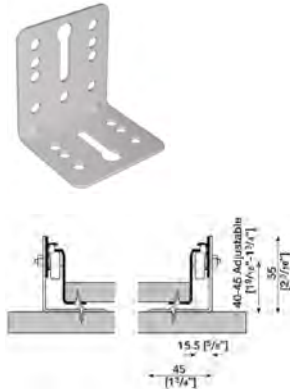

Bottom Mount

Adapter Bracket allows for easy installation of pull-out shelves, silverware or pencil drawers without the use of a side panel. It can be utilized left and right, however, fastening positions are different. Packed 4 pieces per bag with fasteners. Non-toxic epoxy coated finish.

Code	Description	Ctn	List/bg
00432	White Adapter Bracket	50 bgs	\$ 18.97

### HARN FRONT MOUNTING BRACKETS

Clip-On Type, with Press-In Dowels. For Zargen slides.

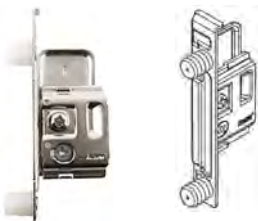

RBF17240RH

Code	Description	List/ea
RBF17240LH	Bracket, Left-Hand	\$ 5.94
RBF17240RH	Bracket, Right-Hand	5.94

### DOUBLE WALL DRAWER BOX SYSTEM

Pride Industrial



- Undermount slides include double wall sides
- Full Extension, 100 lbs. Load Capacity
- 2-Way adjustable
- Lever disconnect
- Length 12" - 22", 4 side heights available
- Material: cold rolled steel
- Stocked in Grey, White available special order

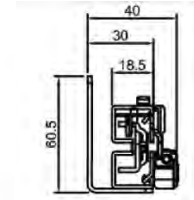
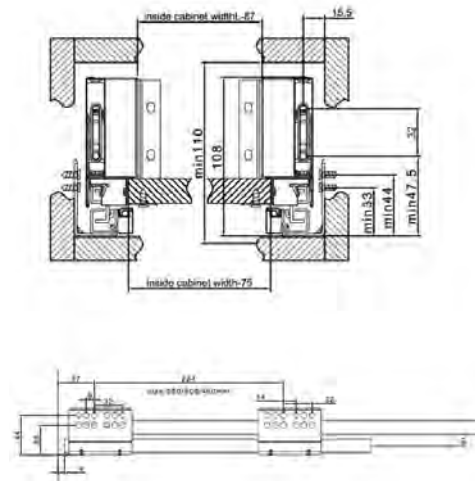

Code	Length	Height	List/pr
90-1488	350mm/ 14"	88mm (3-7/16")	\$ 68.57
90-1688	400mm/ 16"	88mm (3-7/16")	68.80
90-1888	450mm/ 18"	88mm (3-7/16")	68.93
90-2088	500mm/ 20"	88mm (3-7/16")	70.10
90-2288	550mm/ 22"	88mm (3-7/16")	78.71

**Drawer Box Reductions/Box Length Chart**

<b>Undermount Slide</b>	<b>Set Back</b>		<b>1/2" Box Mat</b>	<b>5/8"</b>	<b>Baltic</b>	<b>Opening Height Less:</b>
<b>Pride 9800</b>	4mm	width deduct	5/8"	3/8"	5/8"	3/4"

<b>Hettich Quadro IW21 2D</b>	4mm	width deduct	5/8"	3/8"	11/16"	3/4"
		drawer length	w/o spacer length: 20-7/8" (- 1/8") with spacer length: 21"	w/o spacer length: 21"	w/o spacer length: 20-7/8" (- 1/8") with spacer length: 21"	
Quadro IW21 4D	3.5mm	width deduct	5/8"	3/8"		1"
Quadro IW20	19mm	width deduct	9/16"	5/16"	5/8"	3/4"
		drawer length	14 lengths available. See page			
Actro 5D	3mm + thickness of box		5/8"	3/8"	3/8"	20mm

<b>Grass DynaPro</b>	4mm	width deduct	5/8"	3/8"	11/16"	3/4"
		drawer length	21", 18", 15", 12"	21", 18", 15", 12"	21", 18", 15", 12"	

<b>Salice A7555 / A7557</b>	4mm	width deduct	5/8"	3/8"	11/16"	1"
		drawer length	21", 18", 15", 12" & 24*	21", 18", 15", 12"	21", 18", 15", 12"	
F70	4mm	width deduct	5/8"	3/8"		7/8"

<b>King 1A68F</b>	3-4mm	width deduct	5/8"	3/8"	11/16"	3/4"
		drawer length	21", 18", 15", 12"	21", 18", 15", 12"	21", 18", 15", 12"	

Blum	3mm	width deduct	5/8"	3/8"	11/16"	3/4"
			21", 18", 15", 12", 9"	21", 18", 15", 12", 9"	21", 18", 15", 12", 9"	

\* Order A6555-24



# QUADRO IW21 2D

## QUADRO V6 IW21 2D SOFT CLOSE SLIDES

**QUADRO IW21 2D SOFT CLOSE**  
 For Face Frames - 90 lbs. Dynamic  
 Full Extension

**For Face Frame or  
 Frameless Application**

**90 lbs.**



Setback: 4mm

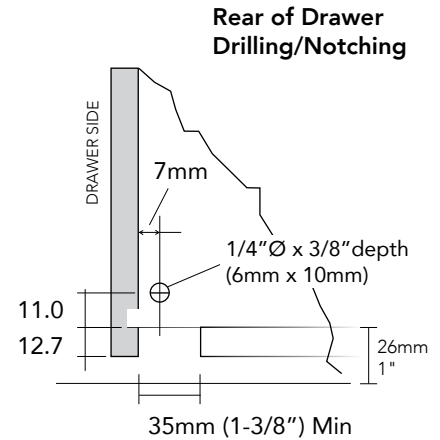
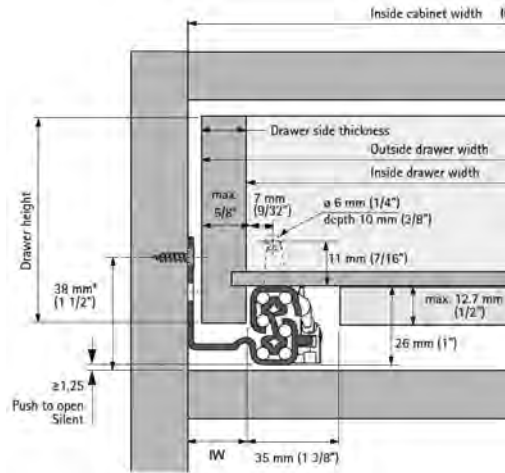

- **Face-Frame Friendly!** : mounts on face frame
- Full extension, Soft-Close: 9", 12", 15", 18", 21", 24"
- Steel Bearings: less sag, 10,000 cycles
- Soft-Closing: **90 lbs.** Dynamic\*, **100 lbs.** static
- Mounts easily on the face frame for overlay drawers
- Drawer material thickness: 1/2" to 5/8"
- **Height** adjustment on front clip, **Depth** adjustment w/ elongated holes on slide, **Side adj. w/ 2D clips**
- Optional Push-To-Open w/ Soft Close

### Dynamic Load Cycles\*

#### Full Extension

**24", 21", 18", 15", 12", 9"**

Smooth soft close. Elongated hole pattern allows setback adjustment. All steel bearings.



Pack: 10 pr. **Silent System Series:**

Code	Drawer Slide Nominal Length	Min Cabinet Depth w/rear brkt	List/pr
9304255-56	9"	10-1/8"	\$ 45.00
9304258-59	12"	13-1/8"	46.00
9304261-62	15"	16-3/32"	48.00
9304271-72	18"	19-3/32"	51.00
9304280-81	21"	22-3/32"	52.00
9304283-84	24"	must block out	65.00

\*ANSI/BHMI Grade 1 on 21" Slide length

### FRONT FIXING CLIPS

#### 2D Front Clips

- **Side adjustment** up to +/- 2mm
- With + 3mm Height adjustment



#### 1D Front Clips

- Height adj. only



Code	Description	List/pr
9306536	<b>2D</b> Front Clip Set for 5/8" mat	\$ 6.60
9306534	<b>1D</b> Front Clip Set for 5/8" mat Height adj.	4.00
9306535	<b>2D</b> Front Clip Set for 1/2" mat	6.00
9306533	<b>1D</b> Front Clip Set for 1/2" mat Height adj.	4.00

### PUSH TO OPEN SETS

Set includes:

- (1) Push to open silent unit, L & R
- (1) activator, L & R
- (2) adapters for synchronization



9308679	66 lbs, 250 - 600mm nl	\$ 62.00 /st
9308678	90 lbs, 400 - 650mm nl	62.00
9236718	Synchronization Bar, 78-3/4"	22.85/ea
9221295	Connectors	2.46

### METAL REAR BRACKETS

9308864 Rear brackets, \$ 5.00 /pr  
 Depth, Side adj





**QUADRO IW21 2D**

Planning dimensions

**IW21 2D**

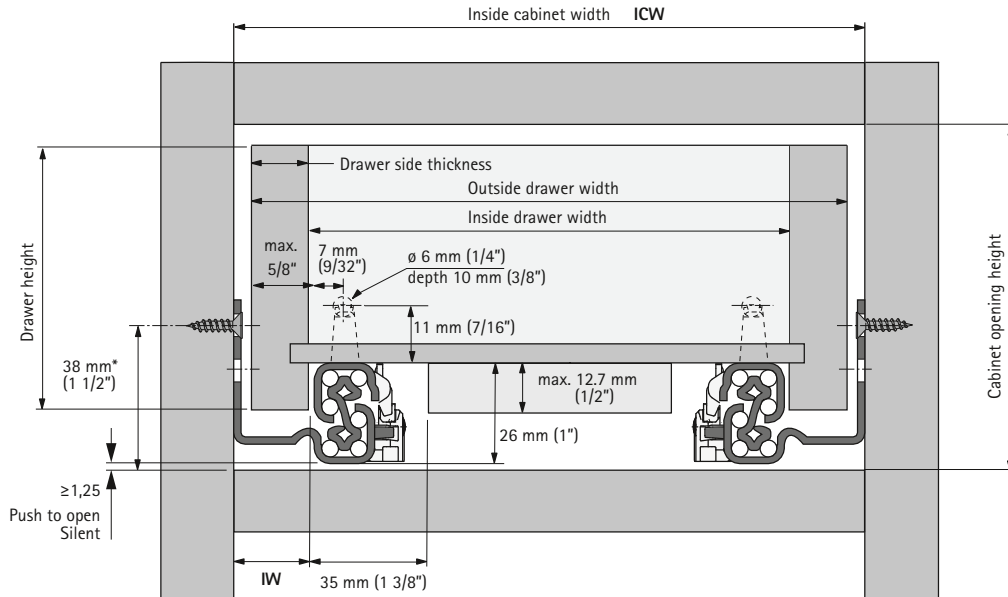

IW = Installation width	21 mm
Drawer side thickness	1/2" (13 mm) 5/8" (16 mm)
Outside drawer width =	ICW - 5/8" (16 mm) ICW - 3/8" (10 mm)
Inside drawer width =	ICW - 1 21/32" (42 mm)

\* 36 mm (1 13/32") with face frame  
\* 38 mm (1 1/2") without face frame

Maximum drawer height = cabinet opening height minus 20 mm (13/16")  
Minimum cabinet opening height = drawer height plus 20 mm (13/16")  
Dimensions in millimeters (inch approximations as noted)

Mounting specifications – (Quadro V6, face frame or frameless application)

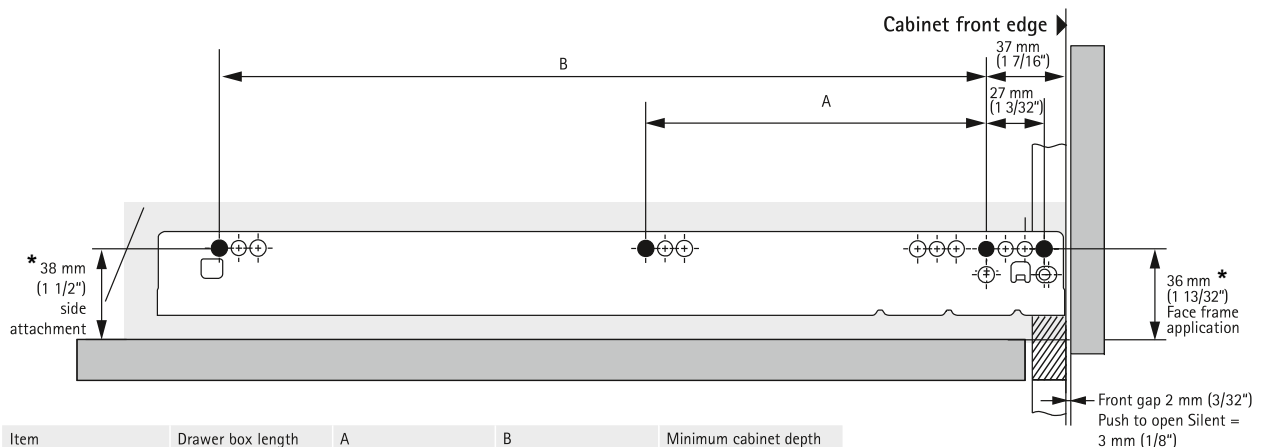

Item	Drawer box length		A		B		Minimum cabinet depth (blocking of frameless cabinet)
	mm	(inch)	mm	(inch)	mm	(inch)	
Quadro V6	229	(9")	128	(5 1/32")	192	(7 9/16")	242,5 (9 17/32")
Quadro V6	305	(12")	160	(6 9/32")	224	(8 13/16")	318,5 (12 17/32")
Quadro V6	381	(15")	160	(6 9/32")	320	(12 19/32")	395 (15 17/32")
Quadro V6	457	(18")	256	(10 1/16")	416	(16 3/8")	471 (18 17/32")
Quadro V6	533	(21")	256	(10 1/16")	480	(18 7/8")	547 (21 17/32")
Quadro V6	610	(24")	256	(10 1/16")	416	(16 3/8")	623,5 (24 17/32")

\* 36mm (1-13/32") with face frame  
\* 38mm (1-1/2") without face frame





# QUADRO IW21 4D

## QUADRO IW21 4D UNDERMOUNT SLIDES

4-Way adjustment for Perfect Gap alignment

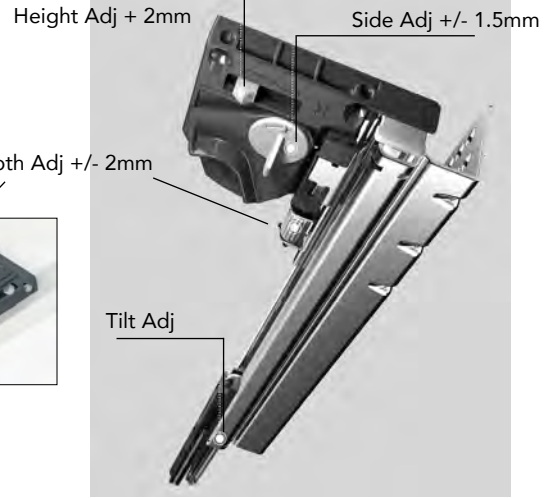

- Load cap: 100 lbs. when mounted to cabinet wall  
 66 lbs. when mounted with a rear bracket
- All steel chrome plated bearings ensure a smooth glide for the entire life of the slide
- Ingrated Silent System closes the drawer quietly and gently
- Tool-free adjustment for height, side, and inset depth. Optional rear tilt bracket is also tool-free.
- Self-cleaning ball-bearing tracks
- Uses #6-58FPDT screws (sold separately)
- Elongated screw holes allow more adjustment

### IW21 4D Rear of Drawer Drilling/Notching

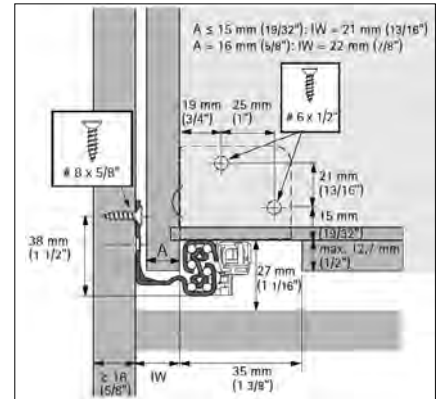
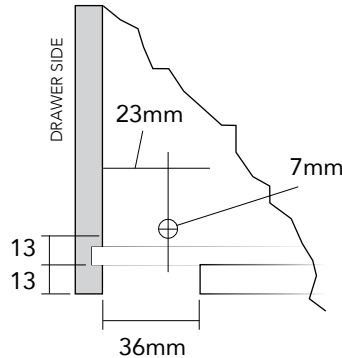

### 4D IW21 Undermount Slides 10 pr/ctn.

Code	Slide Length	Min Cabinet Depth	Length (+0 /-1/16) 4-Sided Drawer Box	List/pr
9181140-41	9"	9-7/8"	9"	\$ 64.65
9181142-43	12"	12-7/8"	12"	54.98
9181144-45	15"	15-7/8"	15"	59.41
9262848-49	18"	18-7/8"	18"	44.70
9262850-51	21"	21-7/8"	21"	48.01
9181150-51	24"	24-7/8"	24"	67.01

Maximum drawer height = cabinet opening height - 20mm (13/16")

2mm case setback,  
 1.5mm drawer front gap.

3.5mm case setback = zero clearance  
 (drawer front touches case)

Code	Description	Ctn	List
9218980	Front Fixing Clips: Includes LH/RH clips and 2 ea. spacers	10 pr.	\$ 3.65/pr
9205924	Tilt Adjustment LH	100	1.24/ea
9205925	Tilt Adjustment RH	100	1.24
9055093	Rear Metal Bracket	10	4.51/str

### Drawer Box Outside Width and Height

For Box Thickness	Deduct from Cabinet Width Opening	Deduct from Cabinet Height Opening
1/2"	5/8"	1"
5/8"	3/8"	1"



**QUADRO IW21 4D UNDERMOUNT SLIDES**

**Mounting specifications**

**QUADRO IW21 4D**

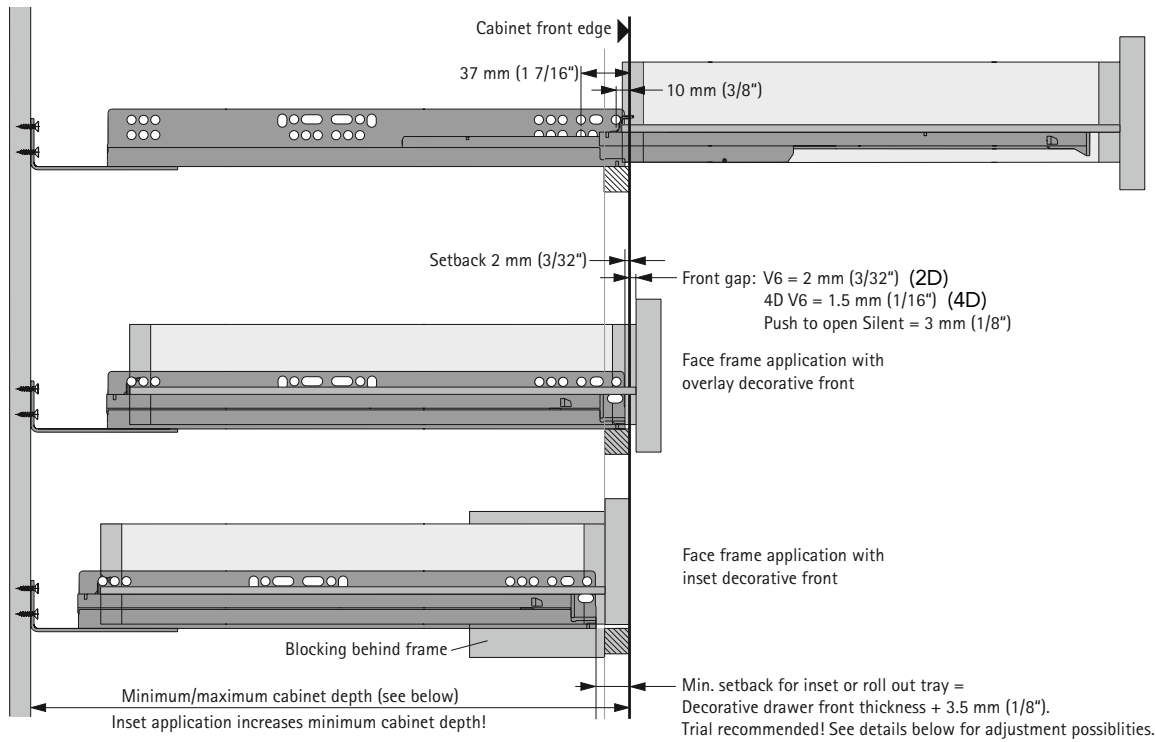

**Minimum / maximum cabinet depth (Quadro 4D V6, face frame application)**

Drawer box length	Min-Max cabinet depth with metal rear attachment		Min-Max cabinet depth with plastic rear attachment (TennTex C-307)		
	mm	(inch)	mm	(inch)	
229 mm	(9")	250 - 300 mm	(9 7/8" - 11 3/4")	270 - 297 mm	(10 5/8" - 11 11/16")
305 mm	(12")	326 - 376 mm	(12 7/8" - 14 3/4")	346 - 373 mm	(13 5/8" - 14 11/16")
381 mm	(15")	402 - 452 mm	(15 7/8" - 17 3/4")	422 - 449 mm	(16 5/8" - 17 11/16")
457 mm	(18")	479 - 529 mm	(18 7/8" - 20 3/4")	498 - 525 mm	(19 5/8" - 19 11/16")
533 mm	(21")	555 - 605 mm	(21 7/8" - 23 3/4")	574 - 601 mm	(22 5/8" - 23 11/16")
610 mm	(24")	no rear attachment, must be blocked out		no rear attachment, must be blocked out	

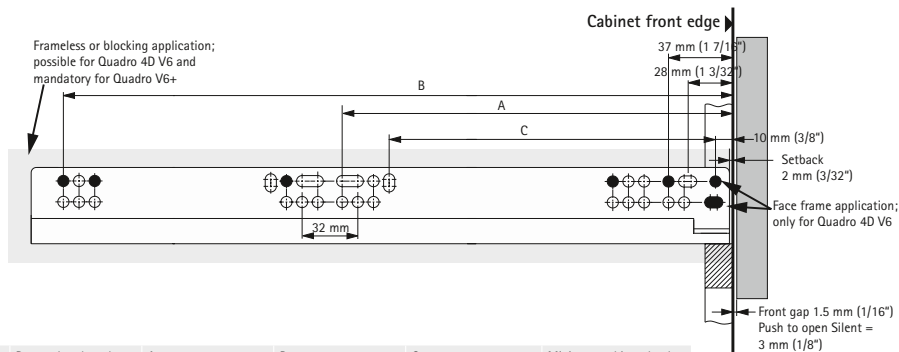

Item	Drawer box length		A	B	C	Minimum cabinet depth (blocking of frameless cabinet)		
	mm	(inch)				mm	(inch)	
Quadro 4D V6	229	(9")	133	(5 1/4")	96	(3 25/32")	250	(9 7/8")
Quadro 4D V6	305	(12")	165	(6 1/2")	128	(5 1/32")	326	(12 7/8")
Quadro 4D V6 / V6+	381	(15")	165	(6 1/2")	357	(14 1/16")	402	(15 7/8")
Quadro 4D V6 / V6+	457	(18")	261	(10 1/4")	453	(17 13/16")	479	(18 7/8")
Quadro 4D V6 / V6+	533	(21")	261	(10 1/4")	517	(20 3/8")	555	(21 7/8")
Quadro 4D V6 / V6+	610	(24")	261	(10 1/4")	453	(17 13/16")	631	(24 7/8")



# QUADRO IW20 4D



## QUADRO IW20 4D UNDERMOUNT SLIDES - 14 Sizes

Adjusts for Inset, Height, and Side, plus Tilt. For perfect gap alignment



Rear Tilt Bracket



- Load cap: 100 lbs. Dynamic
- All steel chrome plated bearings ensure a smooth glide for the entire life of the slide
- Ingrated Silent System closes the drawer quietly and gently
- Tool-free adjustment for **Height, Side, and Inset** depth. Optional rear tilt bracket is also tool-free.
- Self-cleaning ball-bearing tracks
- Use #7-58FPDT screws (sold separately) for slides



Front Clip:  
- Side adj.  
- Height adj.

## 4D Euro Series IW20 - 14 Sizes 10 pr/ctn.

Code	Size	Drawer Lengths, 4 sided drawer, 1/2" material	Min Depth Req.	List/pr
9181186-87	11", 280mm	11-7/16"	12"	\$ 55.05
9181188-89	12", 300mm	12-1/4"	12-3/4"	42.75
9181190-91	13", 320mm	13-1/16"	13-9/16"	55.42
9181192-93	14.2", 350mm	14-3/16"	14-3/4"	56.14
9181194-95	15.4", 380mm	15-3/8"	15-15/16"	56.36
9181196-97	16", 400mm	16-3/16"	16-3/4"	57.45
9181198-99	17", 420mm	16-15/16"	17-1/2"	60.68
9181200-01	18", 450mm	18-1/8"	18-11/16"	61.15
9181202-03	19", 480mm	19-3/8"	19-7/8"	61.75
9181204-05	20", 500mm	20-1/8"	20-11/16"	49.13
9181206-07	21", 520mm	20-15/16"	21-7/16"	62.27
9181208-09	22", 550mm	22-1/16"	22-5/8"	48.12
9181210-11	23", 580mm	23-1/4"	23-13/16"	63.25
9181212-13	24", 600mm	24-1/16"	24-5/8"	60.83

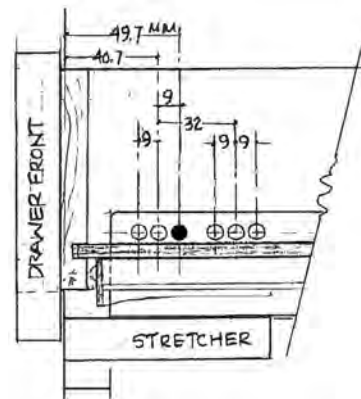
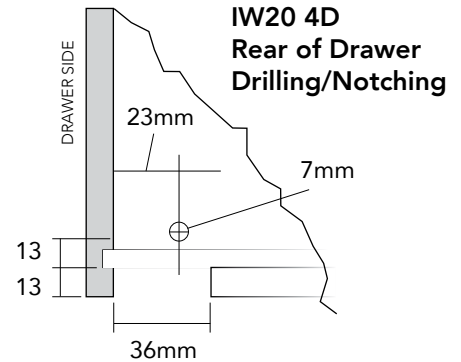

19mm (3/4") Setback (6mm + material thickness)

For 1/2" drawer box material use spacer  
For 5/8" drawer box material, no spacer

Code	Description	Ctn	List
9218980	Front Fixing Clips: Includes LH/RH clips and 2 ea. spacers	10 pr.	\$ 3.65/pr
9205924	Tilt Adjustment LH	100	1.24/ea
9205925	Tilt Adjustment RH	100	1.24
9055093	Rear Metal Bracket	10	4.51/st

### Drawer Box Outside Width and Height

For Box Thickness	Deduct from Cabinet Width Opening	Deduct from Cabinet Height Opening
1/2"	9/16"	3/4"
5/8"	5/16"	3/4"



## REAR OF DRAWER DRILLING/NOTCHING

### GRASS DynaPro

pg 1541-42

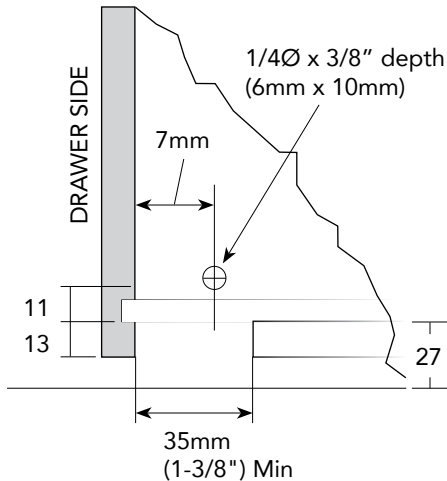

#### Drawer Box Width Calculations

For 1/2" Sides = Opening - 5/8"  
For 5/8" Sides = Opening - 3/8"

Based on exact thickness for oversized material (eg 1/2" +) increase drawer width by 2x extra thickness

#### Example:

On 1/2 sides, drawer opening of 18" = O.D. box width of 17-3/8"

### HETTICH QUADRO

IW21 4D / IW20 4D

pg 1531-32 pg 1533

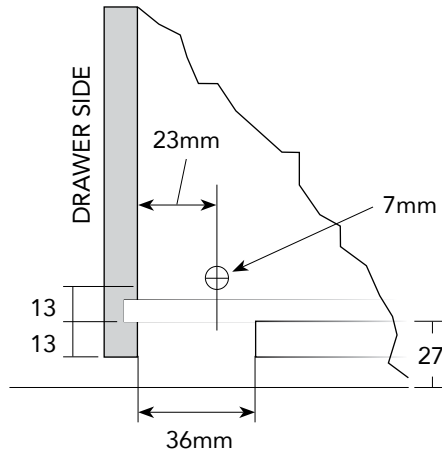

#### Drawer Box Width Calculations

For 1/2" Sides = Opening - 9/16"  
For 5/8" Sides = Opening - 5/16"

Based on exact thickness for oversized material (eg 1/2" +) increase drawer width by 2x extra thickness

IW21 2D

pg 1529-30

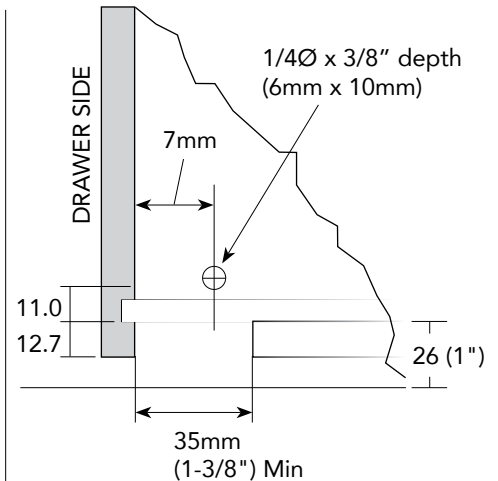

#### Drawer Box Width Calculations

For 1/2" Sides = Opening - 5/8"  
For 5/8" Sides = Opening - 3/8"

Based on exact thickness for oversized material (eg 1/2" +) increase drawer width by 2x extra thickness

### Blum Tandem

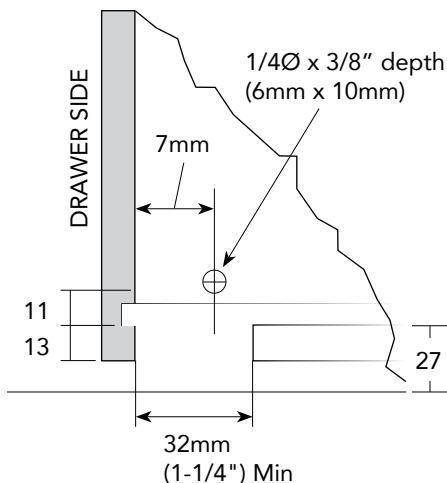

### SALICE A7555

pg 1537-38

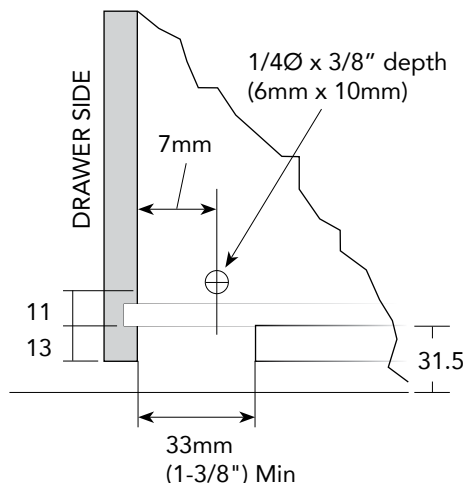

#### Drawer Box Width Calculations

For 1/2" Sides = Opening - 5/8"  
For 5/8" Sides = Opening - 3/8"

Based on exact thickness for oversized material (eg 1/2" +) increase drawer width by 2x extra thickness

#### Example:

On 1/2 sides, drawer opening of 18" = O.D. box width of 17-3/8"

**Hettich ACTRO 5D**

**UNDERMOUNT SLIDES**



**HETTICH ACTRO 5D SOFT CLOSE SLIDES**

**5-way adjustment. Synchronized for wide drawers up to 48"**

Precise 5D adjustment for narrow reveals on large front panels, for a fine furniture look.

Stainless cable for wide drawers up to 48" without racking.



For Face Frame block out sides flush.  
 See box length sizes below.

- Soft Close
- 88 lbs & 154 lbs HD, in stock
- Tool-less adjustments:
  - 1 - Height adj up to + 3mm
  - 2 - Side adj up to +/- 1.5mm (1 touch)
  - 3 - Side rear adj up to +/- 1.5mm (1 touch)
  - 4 - Tilt rear adj +4mm
  - 5 - Depth adj up to +/- 2mm (optional)
- Optional: Push to Open/Soft Close System

Scan here or visit  
 macpac1.com  
 /videos.html for  
 Actro 5D  
 install  
 video

More specs at:  
 macpac1.com/bulletins/Actro5D\_v.3.pdf



**88 lb. Dynamic Load Actro 5D** 10 pr/ Ctn. 14 - 24"

Code	Nominal Length	1/2" box length (No Front Notch)	List/pr
9257067-68	14"	13-7/8"	\$ 63.00
9257071-72	16"	15-13/16"	65.00
9257075-76	18"	17-13/16"	57.00
9257079-80	20"	19-3/4"	58.00
9257083-84	22"	21-3/4"	60.00
9268682-83	24"	23-11/16"	65.00

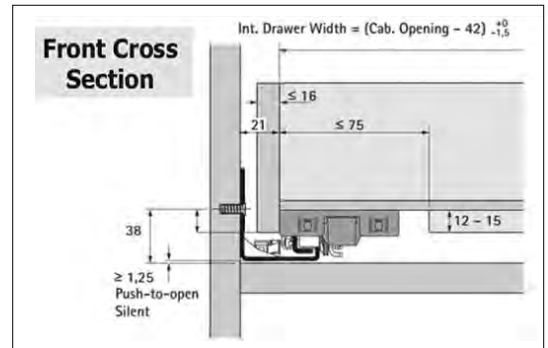

**154 lb. Dynamic Load Actro 5D Heavy Duty** 22 - 30"

Code	Nominal Length	Ctn	List/pr
9257108-09	550mm / 22"	10 pr	\$ 80.00
9257112-13	600mm / 24"	10	85.00
9257114-15	650mm / 26"	5	90.00
9257116-17	700mm / 28"	5	95.00
9257118-19	750mm / 30"	5	99.00

Clips	Description	List
9257268	Front locking clips	10 \$ 15.68 /pr
9257706	Depth adjusters	10 8.40

**Push to Open**

9257892	Wt. range 22 - 88 lbs, 270 - 650mm nominal length	75.00 /st
9257893	Wt. range 44 - 154 lbs, 400 - 650mm nominal length	75.00
9236718	Synchronization Bar, 78-3/4"	22.85 /ea
9221295	Connectors	2.46

**Actro 5D Front Locking Clips**

9257268

- Height adj up to + 3mm
- Tool-less side adj up to +/- 1.5mm

**Actro Push to Open system**

Set includes:

- (1) Push to open silent unit, L & R
- (1) activator, L & R
- (2) adapters for synchronization

**Synchronization Bar for Push to Open Sets**

- 78-3/4" (2000mm) - Cut to Length
- Connectors available for minimizing offcut waste
- Recommended for all widths from 10-13/16" (275mm)
- 5D bar length = Opening minus 8-3/4" (223mm)

## ACTRO 5D

### HETTICH ACTRO 5D SOFT CLOSE SLIDES Specifications

Slide Nominal Length	Min Cabinet Depth with 4-Sided Drawer (overlay)	Drawer Box Lengths		
		3-Sided Nominal Length -10mm	4-Sided (no front notch)	
			1/2" *	5/8" *
350mm	14-1/2"	340 (13-3/8")	13-7/8"	14"
400mm	16-1/2"	390 (15-5/16")	15-13/16"	16"
450mm	18-1/2"	440 (17-5/16")	17-13/16"	17-15/16"
500mm	20-1/2"	490 (19-1/4")	19-3/4"	19-15/16"
550mm	22-7/16"	540 (21-1/4")	21-3/4"	21-7/8"
600mm	24-7/16"	590 (23-3/16")	23-11/16"	23-7/8"
650mm	26-3/8"	640 (25-3/16")	25-11/16"	25-13/16"
700mm	28-3/8"	690 (27-1/8")	27-5/8"	27-13/16"
750mm	30-5/16"	740 (29-1/8")	29-5/8"	29-3/4"

(inch fractions are rounded down to nearest 1/16")

Drawer Box Outside Width	
Box Thickness	Deduct from Opening
1/2"	5/8"
5/8"	3/8"

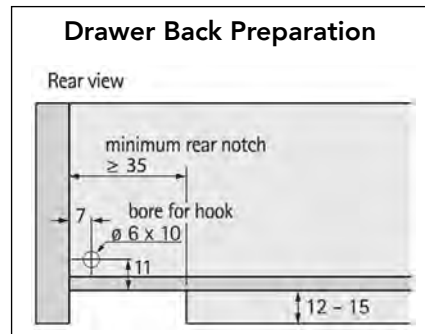

Rear notch is 1-3/8" wide. If depth adjust is used, rear notch should be at least 2-1/8" wide to clear the depth adjust stops.

Setback
3mm + thickness of box
Rear Notch
*min 35mm (1-3/8")
*ideal 55mm (2-1/8")

\* For Thin "Baltic Birch" box material, subtract 1/16" from drawer box lengths.



For a 4-Sided Drawer Box: location of hole #3 = x.  
 1/2" material x = 49.7mm  
 5/8" material x = 52.9mm

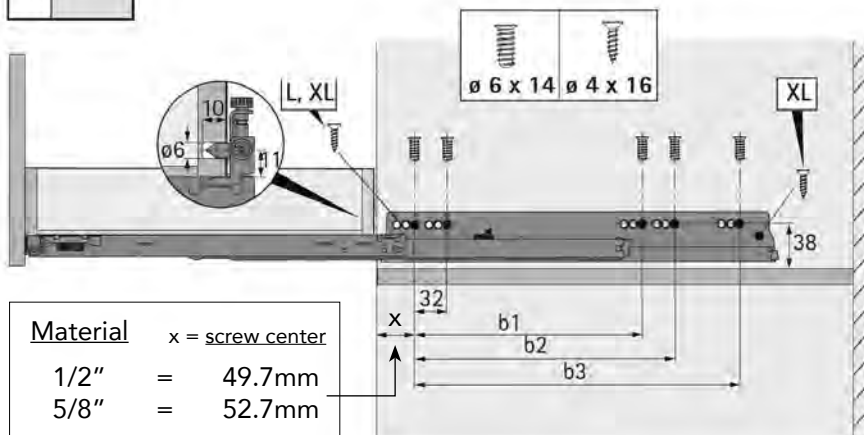

Material	x = screw center
1/2"	= 49.7mm
5/8"	= 52.7mm

NL	b1	b2	b3	
450	224	256	288	(L)
500	224	256	320	(L)
550	224	256	320	(L, XL)
600	224	256	320	(L, XL)
650	224	256	416	(XL)
700	224	256	416	(XL)
750	224	256	416	(XL)

4-sided w/ no front notch

# UNDERMOUNT SLIDES



## SALICE FUTURA A7555: SOFT CLOSE UNDERMOUNT



WOODWORK INSTITUTE **75 lbs.**



**A7555**  
 Undermount  
 with Soft-Close:  
 Full Extension Slide

**Face Frame Friendly:**  
 Mounts on face frame or frameless at 37mm.

- Load Cap 75 lbs. Dynamic, 100 lbs. Static
- ANSI: Grade 1 Certification
- With Smove soft-closing
- Depth Adjust w/ elongated holes
- For 5/8" or 1/2" drawer material
- Adjustments with A750.010 clip:

Height: + 2.5mm  
 Side: +/- 1.5mm  
 Depth: +/- 2mm

### Salice A7555 Soft Close Features:

- Easy pull, smooth roll
- Positive clip-on that adjusts for 1/2" and 5/8" material of drawer side
- Height adjustment 2.5mm
- Standard box sizes - drop in with Blum type notching & drilling
- Stable - less sag when loaded
- Depth Adjustment with elongated mounting holes for inset drawers
- Can be bottom mounted with pre-drilled holes as pull-out shelf
- Removable / Replaceable soft-close damper
- Opening height - 1" to get height of drawer box
- Face Frame Friendly - mounts on face frame or frameless at 37mm

#### Calculation for outside drawer width

Drawer side	5/8"	1/2"
Thickness	(16mm)	(13mm)
Deduct from opening size	3/8" (9mm)	5/8" (16mm)

#### Calculating max drawer height

Deduct 1" (25mm) from opening for max possible drawer height

Standard Box Sizes 21", 18", 15", 12"

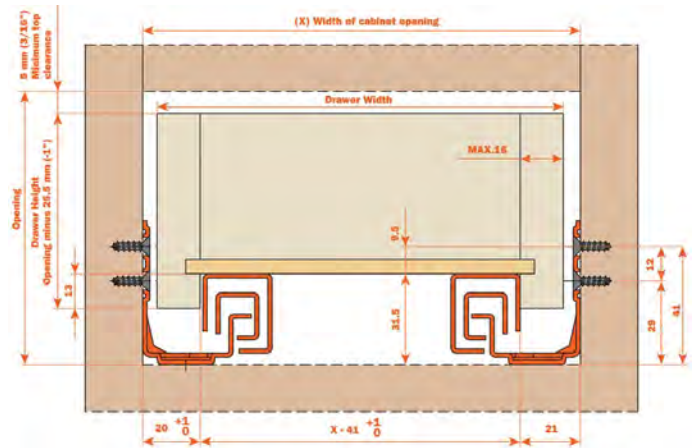
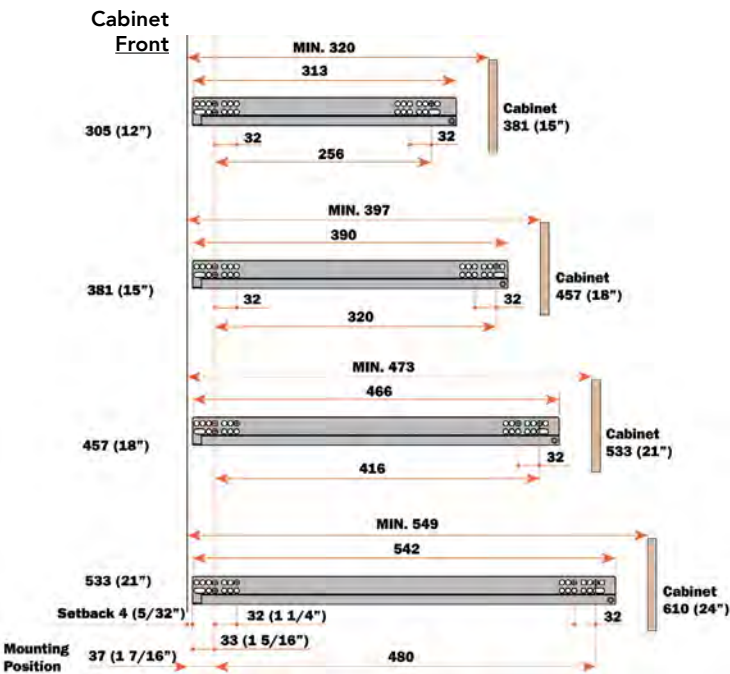

5/32" (4mm) set back from cabinet front edge

#### Drawer back detail

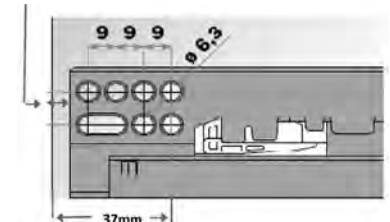
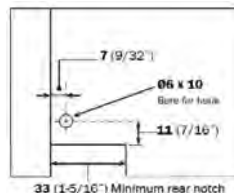

**SALICE**

**UNDERMOUNT SLIDES**

**SALICE A7555: SOFT CLOSE UNDERMOUNT** cont.

Packed: 6 pr/Ctn.

Code	Drawer Length	Depth w/ rear bracket	List/pr
A7555-9	9" / 229mm	264 - 284	\$ 30.86
A7555-12	12" / 305mm	340 - 360	33.18
A7555-15	15" / 381mm	416 - 436	32.32
A7555-18	18" / 457mm	494 - 514	37.32
A7555-21	21" / 533mm	568 - 588	43.42
A6555-24*	1/2" Side = 23-3/4" (603mm) 5/8" Side = 23-7/8" (606mm)		61.46
A710.610	Front Clips		2.55
A720.610	Narrow Front Clips		4.25

\* Not for use with rear bracket. Packed 20 pr/Ctn.  
 Drawer Length = 600mm -10mm + Side thickness

**Side Adjustable Clips w/ Inset adjustment**

6 way adjustable LH/RH clips

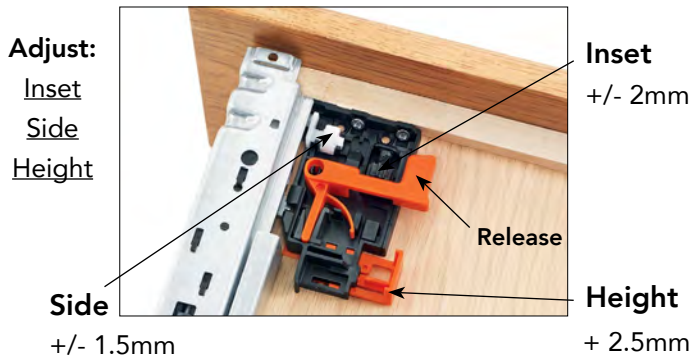

Code	Description	List
A750.010	Front Clips w/ 6 way adjustment including Inset, Ht, Side adjust.	\$ 7.69 /pr
AGSKXC5	Back Bracket	1.26/ea
AGSKXR5	Narrow Back Bracket	1.25

**Salice Adar A7555 Jigs**

These jigs are required when prepping drawers for the Salice Adar A7555.

Different jigs are needed for the A710.610 clips and the A750.010 clips.

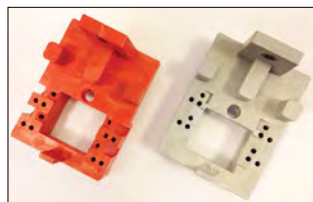

A7555-JIG-STD A7555-JIG

Code	Description	List/ea
A7555-JIG-STD	Jig - Use w/ A710.610 clips	\$ 5.01
A7555-JIG	Jig - Use w/ A750.010 clips	4.25

**SALICE A6555: SOFT CLOSE UNDERMOUNT**

Stocking 24" Length



- Load Cap 75 lbs.
- 24" Length
- ANSI: Grade 1 Certification
- Drawer height adjustment (+2.5mm)
- For 5/8" or 1/2" drawer material
- Not for use with rear bracket

**Load Cap:  
75 lbs.**

Easy pull,  
smooth roll,  
Soft-Close

Fixing full extension runner on cabinet side

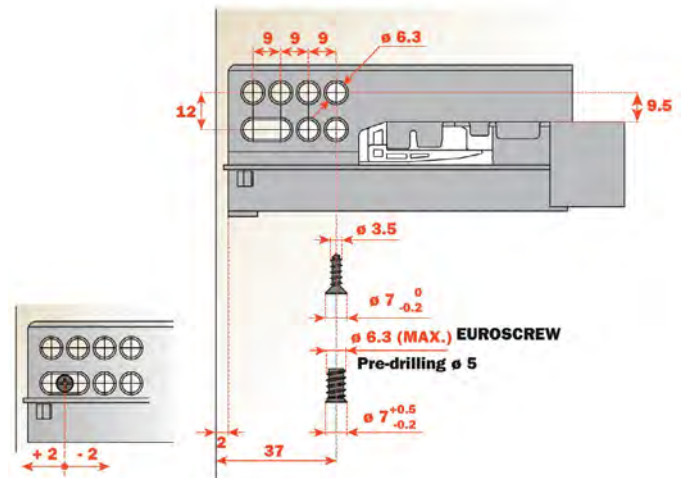

- Positive clip-on that adjusts for 1/2" and 5/8" material of drawer side
- Height adjustment 2.5mm
- Std box sizes - drop in w/ Blum type notching & drilling
- Depth Adjustment with elongated mounting holes for inset drawers
- Can be bottom mounted with pre-drilled holes as pull-out shelf
- Removable / Replaceable soft-close damper
- Opening height - 1" to get height of drawer box - Same as A7555 slide series
- Locates on face frame

Slides Packed: 20 pr/Ctn.

Code	Drawer Length 1/2" or 5/8"	List/pr
A6555-24*	1/2" Side = 23-3/4" (603mm) 5/8" Side = 23-7/8" (606mm)	61.46
A710.610	Front Clips	2.55
A750.010	Front Clips w/ 6 way adjustment including Inset adjustment	7.69

\* Not for use with rear bracket. Packed 20 pr/Ctn.  
 Drawer Length = 600mm -10mm + Side thickness



# UNDERMOUNT SLIDES



## F70 HEAVY DUTY UNDERMOUNT SLIDES

Smove Soft Close, 154 lbs Dynamic

A new generation of heavy duty drawer slides, rated at 170 lbs static and 154 lbs dynamic load capacity. Full extension and a synchronized mechanism with Smove soft closing feature built-in.



F70 Undermount Slide

- 154 lbs Dynamic, 170 lbs Static load capacity
- Full extension with a synchronized mechanism
- Available in 15" to 30" length
- Enhanced smooth soft closing action
- Elongated holes for depth and height adjustment
- Adjustable clips allow for easy drawer insertion and removal; special clip for narrow drawers
- Setback: 4mm
- Tool free height adjustment: + 2.5mm
- Tool free depth adjustment: +/- 3mm
- Tool free side adjustment: +/- 1.5mm
- Optional tool free tilt adjustment: +3mm
- 12mm (1/2") to 16 mm (5/8") drawer thickness
- Compatible with Lineabox drawers



**AFCGX3B**  
 4-Way Adjustable  
 Front Clip Set

**AFCEX43B**  
 Narrow  
 Front Clip Set

### Outside Drawer Width

Drawer Side	5/8" (16mm)	1/2" (13mm)
Inside Cabinet Width Deduction	3/8" (10mm)	5/8" (16mm)



**AGSK7C5B**  
 Rear Socket



**AGSK7R5B**  
 Narrow Rear Socket

Code	Description	Ctn	List
F70-15F	15" (381mm) Face Frame	6 pr	\$ 58.03/pr
F70-18F	18" (457mm) Face Frame	6	61.75
F70-21F	21" (533mm) Face Frame	6	62.79
F70-24	24" (610mm) Frameless	4	93.81
F70-27	27" (686mm) Frameless	4	102.04
F70-30	30" (762mm) Frameless	4	108.28
AFCGX3B	4-Way Front Clip Set	100	6.85
AFCEX43B	Narrow Front Clip Set	100	3.08
F70-TILT	Rear Tilt Adj Set	12	2.19
AGSK7C5B	Rear Socket	100	1.57 /ea
AGSK7R5B	Narrow Rear Socket	100	1.40
F70-JIG	Drilling Jig for Clips/ Rear Hole	1	15.70



**F70-TILT**  
 Rear Tilt Adjustment  
 Set. Max 3mm (1/8")  
 rise of drawer back  
 (tool free).



**F70-JIG**  
 for Clips/  
 Rear Hole

specifications next page



# UNDERMOUNT SLIDES

## F70 HEAVY DUTY UNDERMOUNT SLIDES Specifications

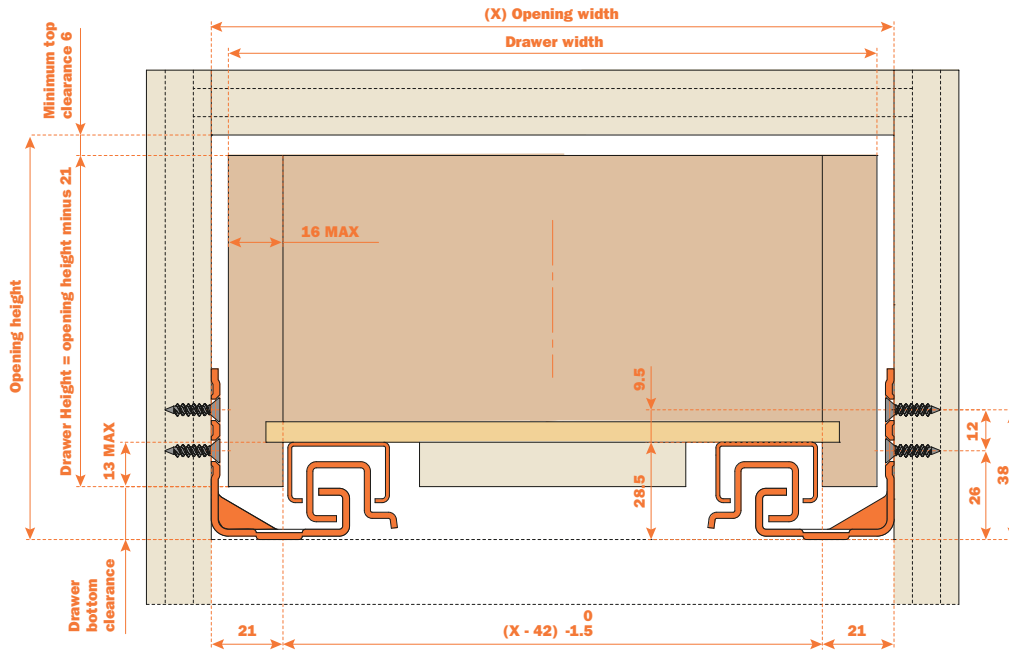

CALCULATION FORMULA FOR OUTSIDE DRAWER WIDTH					
For drawer side thickness of	16 mm (5/8")	15 mm (19/32")	14 mm (9/16")	13 mm (1/2")	12 mm (15/32")
Deduct from inside cabinet width	10 mm (3/8")	12 mm (7/16")	14 mm (9/16")	16 mm (5/8")	18 mm (21/32")

Example: For a 15" inside cabinet width and a 5/8" thick drawer, subtract 3/8" from the inside width of 15" = 14-5/8" drawer width.

**Note:** Drawer side material thickness may vary. Make sure you take precise measurements when calculating outside drawer width using the table below. Inside drawer width must equal opening width minus 42 (1 21/32") for F70 runners to align and function optimally.

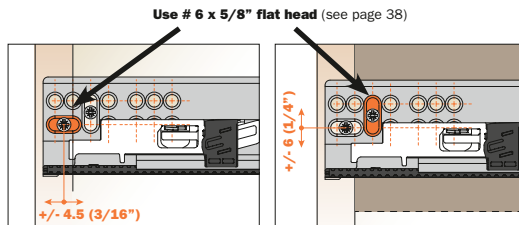
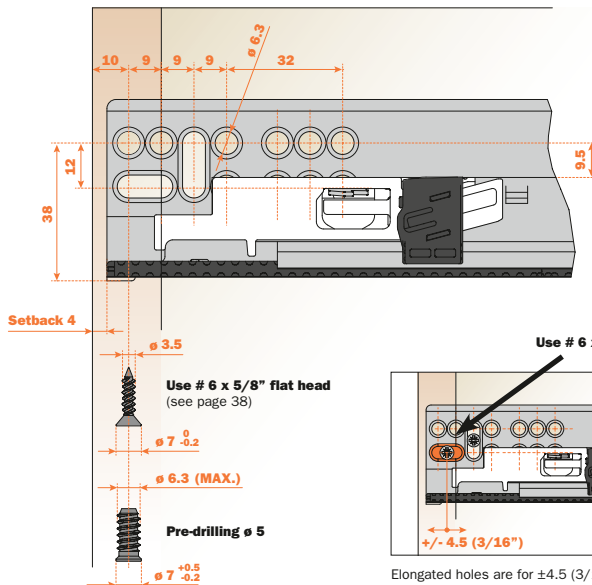

Elongated holes are for  $\pm 4.5$  (3/16") **depth adjustment** only. Additional screws must be used to secure the runner to the cabinet.

Elongated holes are for  $\pm 6$  (1/4") **vertical adjustment** only. Additional screws must be used to secure the runner to the cabinet. Only with frameless application or face frame application with filler.

### Rear Drilling/Notching

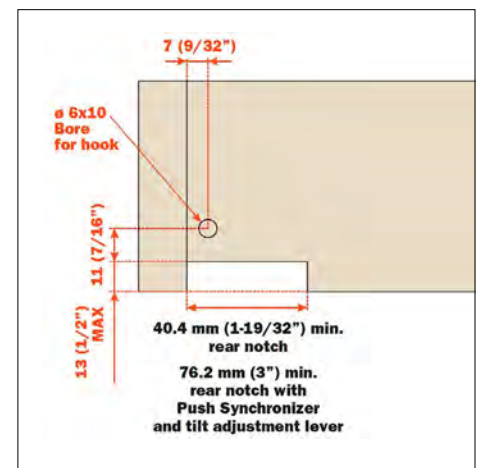

**G\*GRASS** DYNAPRO - CONCEALED UNDERMOUNT SOFT-CLOSE DRAWER SLIDES

**DYNAPRO**

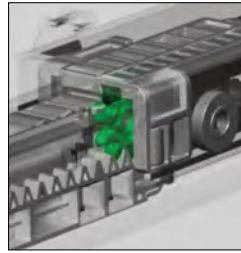
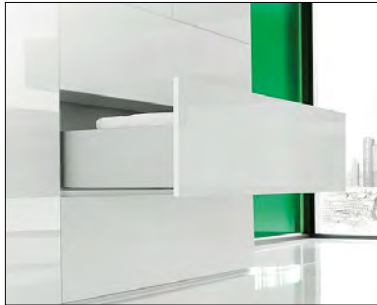

Side Adjustment



Rear Tilt Adjustment

**Syncro-motion**

- Smoothest motion
- Higher Loads
- Wider Drawers
- Takes Standard Drawer Boxes

**Rack & Pinion Design**

- Smooth and Fluid movement
- Progressive / Syncro-motion - no pickup noise
- Minimal side sway - great for wide drawers

**\* Standard Duty:** 100 lbs. Dynamic Load  
 125 lbs. Static Load

**Heavy Duty:** 132 lbs. Dynamic

Calculation Outside Drawer Width

Drawer side thickness	16 (5/8")	15 (9/16")	14 (9/16")	13 (1/2")
Deduct from insid cab. width	10 (3/8")	12 (1/2")	14 (9/16")	16 (5/8")

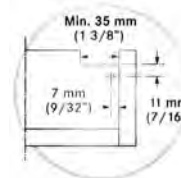

rear notch

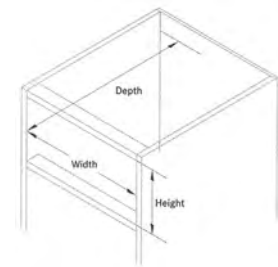

**Frameless**

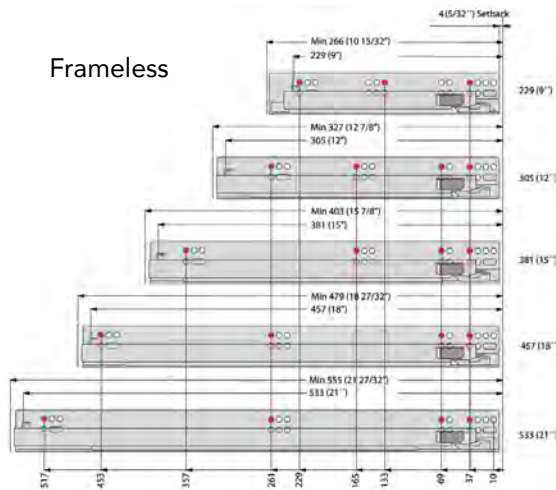

**Face Frame (with rear brackets)**

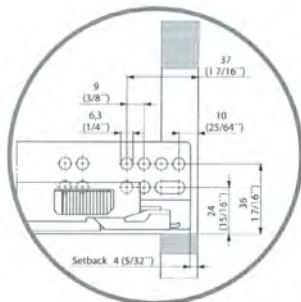
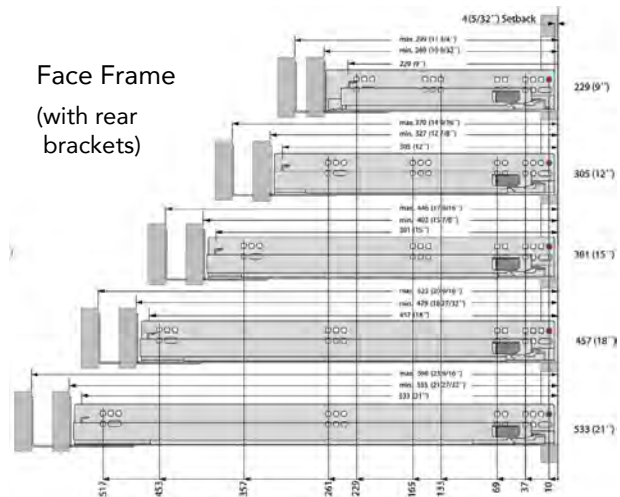

**Frameless Heavy Duty**

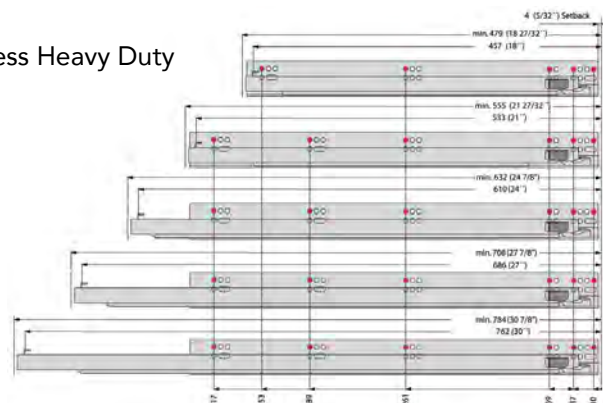

\* Independently Lab tested to ANSI/BHMA Grade 1 spec at 21" size. Listed & acknowledged by WI.



## UNDERMOUNT SLIDES

### DYNAPRO - CONCEALED SOFT-CLOSE DRAWER SLIDES

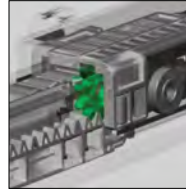

#### Synco-motion

- Smooth and fluid movement
- Progressive / synco-motion - no pickup noise
- Minimal side sway - great for wide drawers

- Soft-pull, soft-close
- 100 lb. load Standard Duty, 132 lb. Heavy Duty
- Made in Austria; **Grass**
- Pull force of only 20 Newtons
- 2-D adjustment front clip - height, side-to-side
- 3-D Tilt adjustment rear clip
- Slotted holes - front to back inset adjustment
- Concealed soft-close mechanism - dust free operation
- Support roller - less deflection, consistent reveal
- Ratcheting point of attachment - tolerance for drawer box sizing

#### 100 lb. Dynamic Load - 2D Height and Side Adjustment

Code	Length	Ctn	List/pr
DP-9	9"	5 pr.	\$ 54.34
DP-12	12"	5	49.83
DP-15	15"	5	53.33
DP-18	18"	5	52.80
DP-21	21"	5	55.20

#### 100 lb. Dynamic Load - 3D Height/Side/Tilt Adjustment

DP-9-3D	9"	5 pr.	\$ 83.28
DP-12-3D	12"	5	50.13
DP-15-3D	15"	5	54.36
DP-18-3D	18"	5	52.12
DP-21-3D	21"	5	53.72

#### 132 lb. Heavy Duty

#### Heavy Gauge Steel, 3D Height/Side/Tilt Adjustment

DP-18-HD	18"	5 pr.	\$ 108.18
DP-21-HD	21"	5	110.69
DP-24-HD	24"	5	132.03
DP-27-HD	27"	5	161.94
DP-30-HD	30"	5	194.72

### DYNAPRO CLIPS / BRACKETS

#### Front Clips

For All DynaPro Slides, provides height & side adjustment.  
 Min Inside Drawer Width: 7-3/32".



DP-CL (LH)  
 DP-CR (RH)



Code List/ea  
 DP-CL / CR \$ 4.77

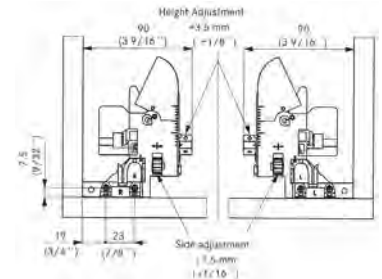

#### Rear Clips for 3D

The 3D rear clips provide tilt adjustment for the DynaPro 3D slides and the DynaPro 3D Heavy Duty slides.



DP-CL-3D (LH)  
 DP-CR-3D (RH)



Code List/ea  
 DP-CL-3D / CR-3D \$ 1.68

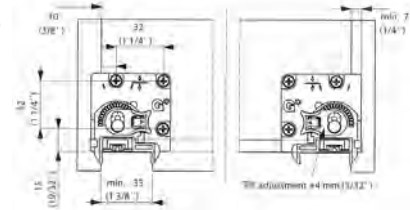

#### Depth Adjuster: for Inset Drawers

- Gives +4.5mm forward adjustment
- Works with all DynaPro slides
- For narrow and standard width drawers



Inset depth adjustment  
 Snaps onto slide

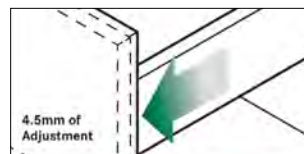

Depth adjustment  
 (+4.5mm forward)

Code List/pr  
 DP-I \$ 6.78



## UNDERMOUNT SLIDES

### DYNAPRO CLIPS & BRACKETS

Continued from previous page

#### Narrow Front Clips

Optional

DP-CL-N (LH)  
 DP-CR-N (RH)

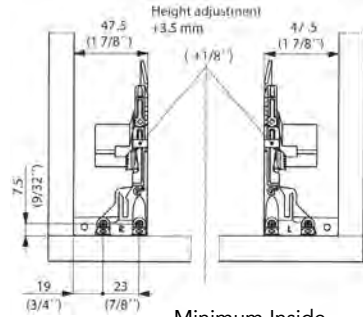

Minimum Inside  
 Drawer Width: 3-3/4"

Code List/ea  
 DP-CL-N / CR-N \$ 3.97

#### 6 Way Front Clips

Inset + Height + Side Adjustment

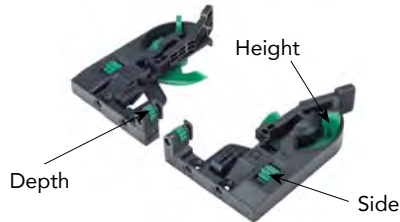

DP-CL3, DP-CR3

- Fits all DynaPro Slides
- Minimum inside drawer width 150mm (5-7/8")
- For drawer sides 1/2" to 3/4" (13 - 19mm)
- Lightweight, high strength polymer

- Height adj. range: + 3.5mm
- Side adj. range: ± 1.5mm
- Inset adj.: 3.0mm out adj. only

- Available with or without flanges

DP-F-CL,  
 DP-F-CR  
 6-Way Front Clip  
 with Flanges



Code	Description	List/ea
DP-CL3	Left 3D Front Clip	\$ 2.62
DP-CR3	Right 3D Front Clip	2.62
DP-F-CL	Left 3D Front Clip, w/ flange	2.21
DP-F-CR	Right 3D Front Clip, w/ flange	2.94

#### Eco 1D Front Clips

Optional

These economically priced clips offer simplified 1D height adjustability. No built-in side adjustment.



Code List/ea  
 DP-CL-1D / CR-1D \$ 2.10

DP-CL-1D (LH)  
 DP-CR-1D (RH)

#### Rear Mounting Brackets

Length: 2-13/16"  
 Height: 2-1/4", Width: 2"

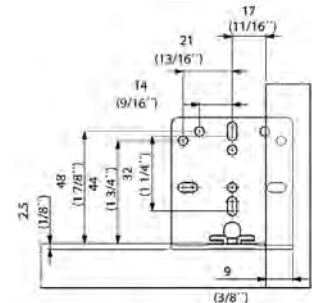

Code List/ea  
 7950 \$ 2.18

#### Narrow Rear Mounting Brackets

Optional

Narrow Rear Mounting Brackets for 12" to 21" DynaPro Slides. Non-handed.

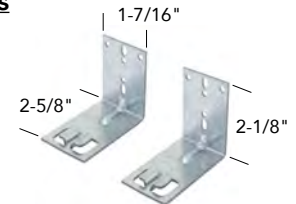

Code List/ea  
 7951 \$ 2.60



## UNDERMOUNT SLIDES

### GRASS DYNAPRO UNDERMOUNT SLIDES

#### For 3/4" Material

- Frameless application for 3/4" (19mm) drawer material
- Full extension with a synchronized mechanism
- Soft close damping system
- Maximum connection to drawer slide and front locking device
- Integrated adjustment for alignment
- Height adjustment + 3.5mm
- Side adjustment ± 1.5m



#### 3/4" Material - Calculation Outside Drawer Width

Drawer side thickness	19 (3/4")	18 (23/32")	17 (21/32")
Deduct from insid cab. width	11 (7/16")	13 (1/2")	15 (9/16")

Packed: 5 pr/Ctn. Uses same clips and brackets shown on previous pages.

### 3/4" material - 100 lb Dynamic Load

Soft-Close, 2-D adjustment, for Frameless applications

Code	Description	Min Inst. Depth	List/pr
DP-34-12	12", 3/4" mat	12-7/8"	\$ 60.84
DP-34-15	15", 3/4" mat	15-7/8"	67.41
DP-34-18	18", 3/4" mat	18-27/32"	66.44
DP-34-21	21", 3/4" mat	21-27/32"	63.30

### 3/4" material - 100 lb Dynamic Load

Soft-Close, 3-D adjustment, for Frameless applications

DP-34-9-3D	9", 3/4" mat		\$ 80.96
DP-34-12-3D	12", 3/4" mat		66.27
DP-34-15-3D	15", 3/4" mat		66.73
DP-34-18-3D	18", 3/4" mat		61.11
DP-34-21-3D	21", 3/4" mat		72.16

### Heavy Duty for 3/4" material - 132 lb Dynamic Load

Soft-Close, 3-D adjustment, for Frameless applications

DP-34-18-HD	18", 3/4" mat	18-27/32"	\$ 111.84
DP-34-21-HD	21", 3/4" mat	21-27/32"	115.01
DP-34-24-HD	24", 3/4" mat	24-7/8"	140.53
DP-34-27-HD	27", 3/4" mat	27-7/8"	160.55

### DYNAPRO DRILLING JIGS

#### DynaPro Drilling Jig for DP-CL/CR Front Clips

Helps determine the position of the drill holes for the non-flange universal front locking devices.



#### DP-04

Jig shown being used with centering drill bit (sold separately)

#### DynaPro Drilling Jig for DP-CL-3D/CR-3D

Used to pre-drill holes for rear tilt 3D clips DP-CL-3D and DP-CR-3D on 16mm or 19mm material.



#### DP-05

Code	Description	List/ea
DP-04	Drilling Jig for DP-CL/R	\$ 30.00
DP-05	Drilling Jig for DP-CL/R-3D	30.00

#### DynaPro Jig for installing Front Clips, drawer hook, rear tilt.

Drawer Drilling Template for drilling front locking devices, drawer hole hook, or adjustment adapters.



For Drill Bit, use: 151-1564  
15/64" (5.95mm)

For Drill Stop, use: 106-1564

Code	List/ea
DPJIG	\$ 58.55

#### Jig for installing DP Slides:

Locate holes on **cabinet side**. For frameless cabinets or face frame with blocked out sides.



3mm setback.  
Use with a Vix-bit to pre-drill.

Code	List/ea
DPJIG-CAB	\$ 39.30

# UNDERMOUNT SLIDES

**PRIDE**

## PRIDE 9800 UNDERMOUNT SLIDE

Soft-Close, Full Extension, 90 lbs.



Clips Included

- Full extension, 90 lb. rating
- Front locking clips are included
- Height adjustable (0 ~ +3mm)
- Elongated holes for depth/inset adjustment
- 4 Sizes: 12" - 21"
- Rear bracket (optional)

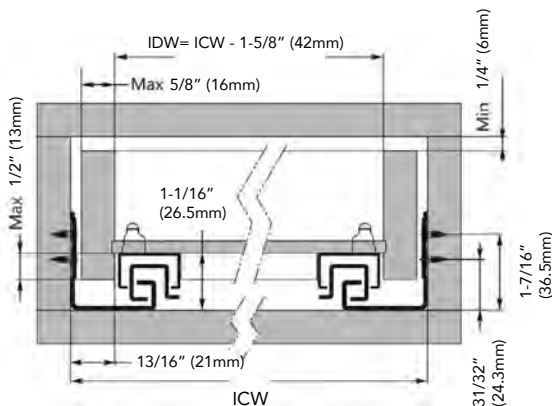

Installation for drawers between 1/2" - 5/8" (12.7mm-16mm) thick drawer sides

IDW = Internal Drawer Width  
 ICW = Internal Cabinet Width

### Outside Drawer Width

Setback: 4mm	Drawer Side	5/8" (16mm)	1/2" (13mm)
	Inside Cabinet Width Deduction	3/8" (10mm)	5/8" (16mm)

Drawer Length	Runner Length	Inside Cabinet for rear bracket	
		Max Depth	Min Depth
12"	12-1/2" (317mm)	14-9/16" (369mm)	12-7/8" (326mm)
15"	15-1/2" (394mm)	17-9/16" (446mm)	15-7/8" (403mm)
18"	18-1/2" (470mm)	20-9/16" (522mm)	18-7/8" (479mm)
21"	21-1/2" (546mm)	23-9/16" (598mm)	21-7/8" (555mm)

Slides: Pack 6 pr/Ctn. Brackets: 100 pr/Ctn.

Code	Description	List
9800-12-SOFT	12" Soft Close w/ clips	\$ 30.45/pr
9800-15-SOFT	15" Soft Close w/ clips	29.07
9800-18-SOFT	18" Soft Close w/ clips	30.25
9800-21-SOFT	21" Soft Close w/ clips	32.20
9800-BRKT	Metal Rear Bracket	1.47 /ea
9810-BRKT	Plastic Rear Bracket	2.45

## Slide Specifications / Installation for 9800 slides

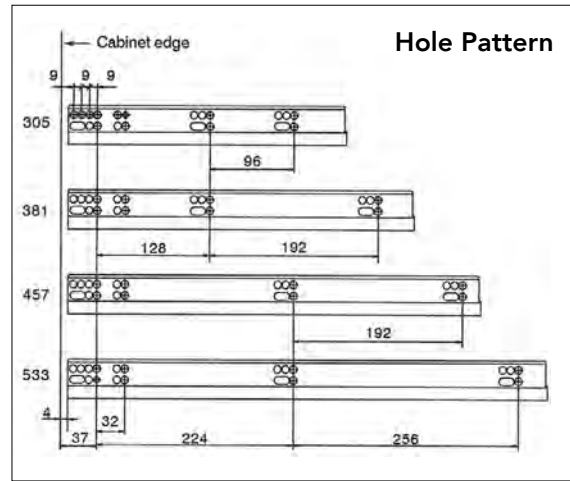

### Installation Dimensions

NL = nominal slide length    LT = internal cabinet depth

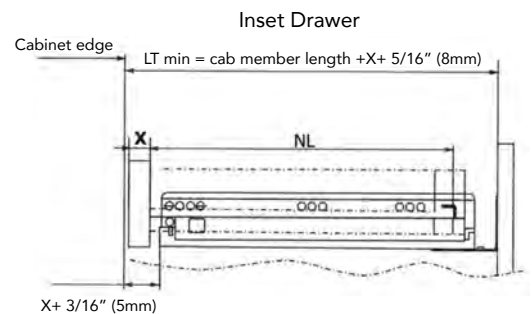
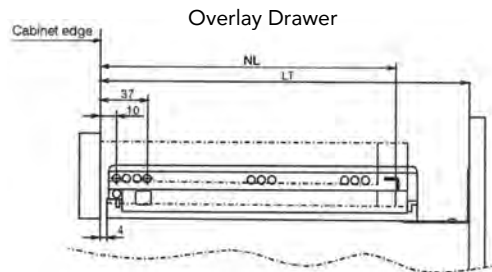

9800-BRKT



9810-BRKT

Drawer back for Soft Close slide 1-3/8"

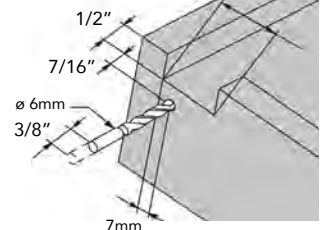

# KING

# UNDERMOUNT SLIDES

## KING SLIDE Advanced Design, Full Extension, Soft Close



**1A68F**

**75 lbs.  
 Dynamic**

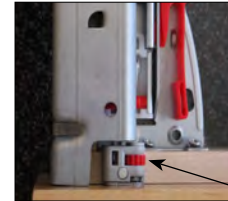

Adjuster

KC-I Adjustment Device  
 for Inset Drawers

Allows 3/16" 'out' adjustment

- Ultra smooth gliding motion, silent soft-close
- Light opening effort, full-extension
- Easy 3.5mm height adjustment on drawer front
- Drawer fronts install at the vertical - no "shingling" design (pat.)
- 2" length of soft close action - early pick up
- "Drop in" sizes & std 32mm hole patterns
- ANSI/BHMA rated, tested to 100,000 cycles, Load Cap: 75 lbs.

### Installation Specification

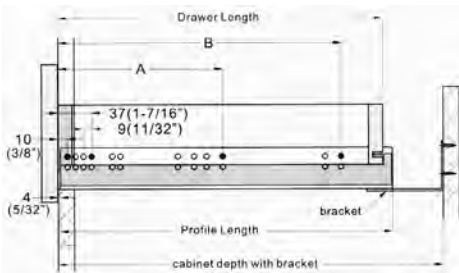

### Space Requirement

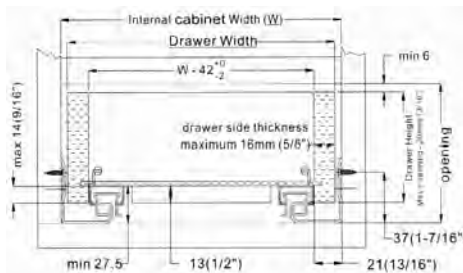

1A68F Drawer Width Formula	
drawer side thickness	"W" minus
16 (5/8")	10 (3/8")
15 (19/32")	12 (15/32")
14 (9/16")	14 (9/16")
13 (1/2")	16 (5/8")
12 (15/32")	18 (23/32")

W: Internal cabinet Width

Example:

Internal cabinet Width = 457mm (18")  
 Drawer Side Thickness = 13mm (1/2")  
 Drawer width = 457 - 48 = 409mm  
 (18") - (1-29/32") = 16-3/32"

Drawer Length	Drawer Box Length	Overall Cab Depth	Cab Depth w/Brkt Max	Cab Depth w/Brkt Min	Profile Length
9"	9"	12"	-	-	10-1/16"
12"	12"	15"	14-9/16"	12-7/8"	12-1/2"
15"	15"	18"	17-9/16"	15-7/8"	15-1/2"
18"	18"	21"	20-9/16"	18-7/8"	18-1/2"
21"	21"	24"	23-9/16"	21-7/8"	21-1/2"
24"	23-5/16"	27"	-	-	-

Note: For King 24" slide, the mounting of the cabinet member on the edge panel is 37mm setback, using the second hole from the front of the cabinet member.

### Some King Slide Advantages compared to Competition:

- 1) Height adjustment has little effect on drawer front angle (shingling)
- 2) No separate rear adjustment needed to prevent shingling
- 3) Soft close functions even if drawer is opened and closed rapidly
- 4) Tolerance for drawer width: +0/-2mm
- 5) Drawer depth tolerance: +1/-1mm

Packing: 6 sets/box. Full boxes only.  
 Front mounting clips and rear brackets included.

### For 1/2" to 5/8" material

Code	Length	List/pr
1A68F-9*	9"	\$ 47.72
1A68F-12*	12"	49.83
1A68F-15*	15"	35.09
1A68F-18	18"	37.63
1A68F-21	21"	39.28
1A68F-24*	24"	46.26

KC-I Adjustment device for Inset Drawers 5.16

\* Special Order





## SENSOMATIC - PUSH TO OPEN



### SENSOMATIC FOR DYNAPRO

Combine handle-free opening with the ever popular Soft-closing action. Just tap anywhere on the drawer front and the drawer opens automatically. The Sensomatic is an electro-mechanical opening system that works with the Dynapro slide system. One drive unit for cabinets widths up to 47-1/4" (1200mm). Ideal for waste bins and handle-free cabinet styles. Three settings for opening force.



Scan here to see Installation Video or go to [macpac1.com/videos.html#grass](http://macpac1.com/videos.html#grass)

### Standard Cabinet with horizontal wooden stretcher

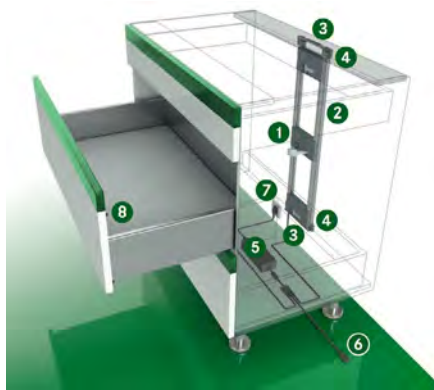

#### ① Opening Unit

For DynaPro:

3 Force Settings



Code List/ea  
F12-268 \$ 230.54

#### ② Frame Sides

Including Frame Side Cable, 750mm (29-1/2")



Code List/ea  
F12-285 \$ 167.89

#### ③ Frame Connector



Code List/ea  
F12-282 \$ 3.80

#### ④ Fixing Bracket



Code List/ea  
F12-270 \$ 6.64

#### ⑤ Power Supply Unit



Code List/ea  
F12-269 \$ 366.73

One power supply operates up to 30 opening units.

#### ⑥ Connection Cable w/ 2-way adapter



63" (1600mm)

Code List/ea  
F12-290 \$ 44.57

#### ⑦ Power Cord, 6'



Code List/ea  
F12-760 \$ 53.98

#### ⑧ Spring-loaded Front Bumper



Code List/ea  
F12-295 \$ 2.80

Front Gap: 3mm

#### Synchronization Cable

Up to three opening units can be activated at the same time if they are connected using the synchronization cable. 32' 9/16" (10m)



Code List/ea  
F12-287 \$ 22.86

### Waste Bin Cabinet with bottom panel frame mounting



#### Sensomatic Kit

Includes:

- (1) Opening unit
- (1) Base Frame
- (1) Power Supply unit
- (1) Power Cord
- (4) Front bumpers



Code List/ea  
F12-697 \$ 647.08

#### ⑨ Four-way Adapter



Code List/ea  
F12-293 \$ 66.83

## UNDERMOUNT SLIDES

## PUSH TO OPEN

### DYNAPRO PUSH TO OPEN / SOFT CLOSE SETS

Tipmatic sets for 5/8", 1/2" and 3/4" material

The Tipmatic Soft-Close opening system featuring push to open and soft close ensures elegant movement irrespective of the weight and size of the drawers.

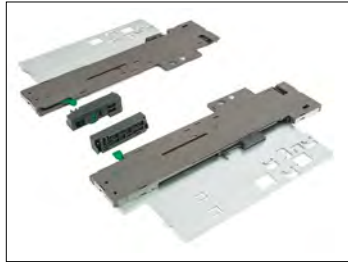

DP-TIPSC Unit and Activator



DP-ROD synchronization bar

Inside Cab width > 8-1/2" (216mm)

- Mechanical opening system for handle-free drawer fronts
- Combines Tipmatic function with Soft Closing
- One kit adjusts for all weight classes: 0 to 132 lbs Dynamic
- Compatible with 2D, 3D & HD DynaPro slides, 12" - 30"\*
- Wide activation zone due to synchronization bar - push anywhere on the drawer front
- Tool-free assembly, no new notching required
- Compatible with all existing DP front locking devices

Order Tipmatic sets and synchronization bars separately.

\*Note that this unit does not work with 9" slides.

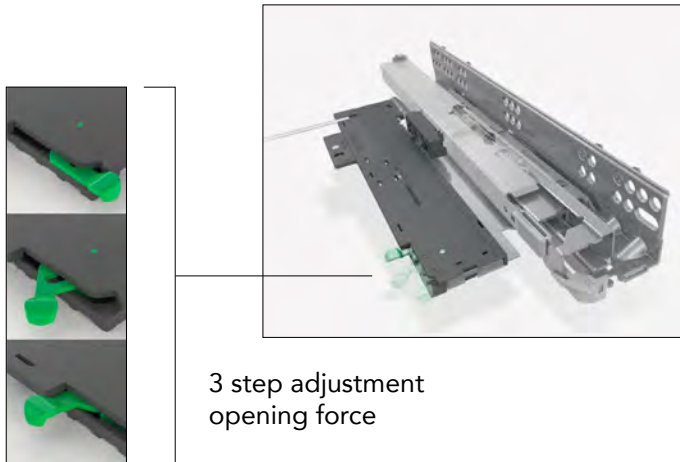

3 step adjustment opening force

Code	Description	Ctn	List
DP-TIPSC	Tipmatic unit & activator	10	\$ 79.63 /st
DP-ROD	Synchronization bar - cut to length, 37-1/2"	10	10.90 /ea

### GRASS TIPMATIC TOUCH-LATCH

For "Push to Open" Conversion (Not Soft-Close)

RH: 601223 (9" - 12")  
 101300 (15" - 21")  
 LH: 600223 (9" - 12")  
 101301 (15" - 21")



gap adjustment

Tipmatic touch-latch mechanism for DynaPro Slides. A customer with an existing soft-close DynaPro slide can simply "knock-out" the existing soft-close mechanism and snap in a Tipmatic touch latch mechanism. Rated for drawers up to 24" wide.

#### Step 1.

Remove existing soft-close mechanism. To remove, use a flat blade screw driver to release the side tab, and push forward on the entire mechanism.



Slide mechanism forward to release from holding tabs.

#### Step 2.

Slide is now clear of soft-closing mechanism

Install Tipmatic mechanism (push to open). Properly installed, the mechanism is seated and locked with all four tabs, and locking tab is secure.

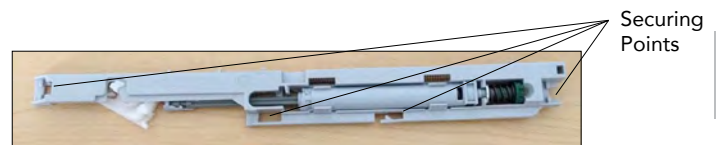

Securing Points

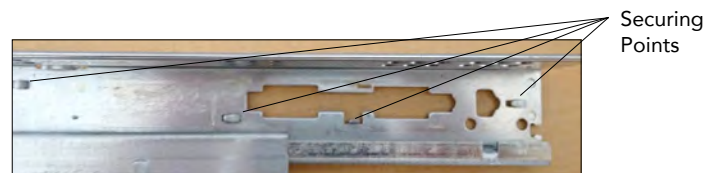

Securing Points

Code	Description	Ctn	List/ea
601223	RH Tipmatic for 9" - 12"	50	\$ 22.77
600223	LH Tipmatic for 9" - 12"	50	22.78
101300	RH Tipmatic for 15" - 21"	50	18.30
101301	LH Tipmatic for 15" - 21"	50	19.39

**PUSH TO OPEN**

**UNDERMOUNT SLIDES**



**SALICE: PUSH SLIDE**

Full Extension, Concealed Slide, Hands Free Opening

**SALICE**

**Face Frame Friendly!**

**PUSH:** This opening system for drawers is fully integrated in the runner. A slight pressure on the drawer front allows the drawer to self-open, hands-free. No visible hardware.

**A7557  
 Push**

**A7557 PUSH**

Face-Frame  
 Friendly



Pack: 6 pr/box.

Code	Drawer Length	Runner Length	Inside Cabinet Depth		List/pr
			Min*	Max*	
A7557-12	12"	315mm	12-13/16"	14-3/8"	\$ 33.23
A7557-15	15"	391mm	15-7/8"	17-7/16"	34.02
A7557-18	18"	467mm	18-7/8"	20-3/8"	38.34
A7557-21	21"	543mm	21-7/8"	23-3/8"	42.83
A710.610	Front Clips			100 pr/Ctn.	\$ 2.55
AGSKXC5	Metal Back Bracket			100 ea/Ctn.	1.26/ea

\* with metal bracket

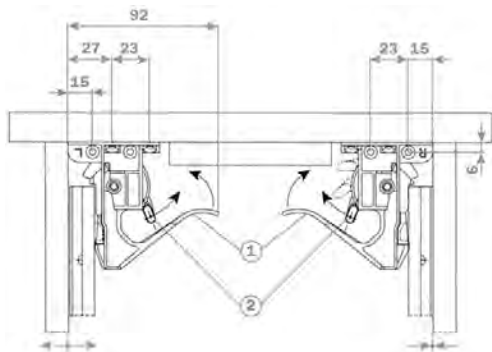
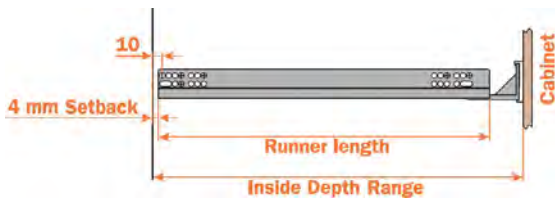

Internal drawer (view from below)

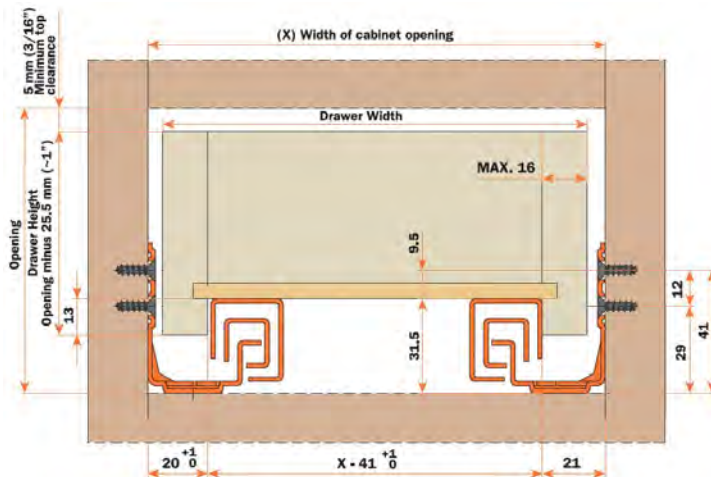
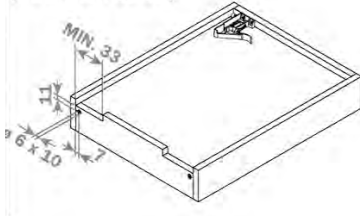

**Calculation Formula for Outside Drawer Width**

For drawer side thickness of:	16mm (5/8")	15mm (19/32")	14mm (9/16")	13mm (1/2")	12mm (15/32")
Deduct from inside cabinet width:	9mm (3/8")	11mm (7/16")	13mm (1/2")	15mm (5/8")	17mm (21/32")

Example: For a 15" inside cabinet width and a 5/8" thick drawer, subtract 3/8" from the inside width of 15" = 14-5/8" drawer width.

## HETTICH

## QUADRO PUSH TO OPEN

### QUADRO IW20 4D PUSH TO OPEN UNDERMOUNT SLIDES

4-Way adjustment for Perfect Gap alignment

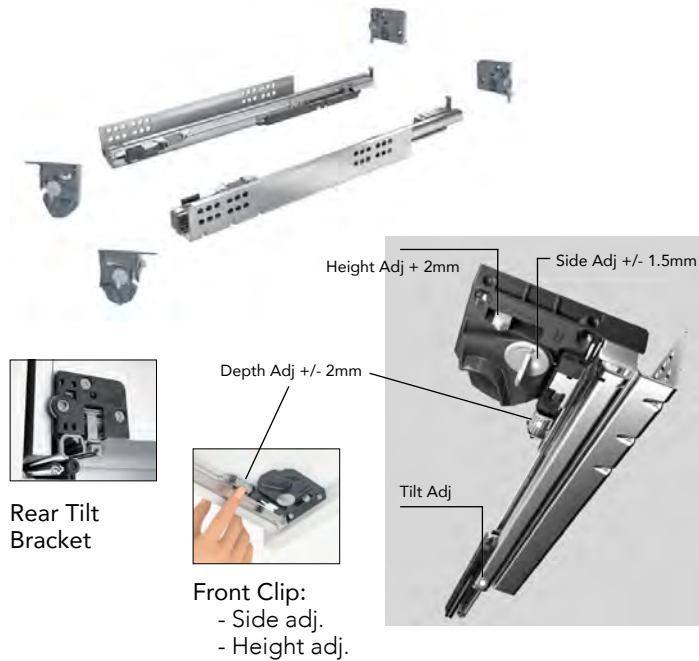

Rear Tilt Bracket

Front Clip:  
 - Side adj.  
 - Height adj.

- Load cap: 100 lbs. Dynamic.
- All steel chrome plated bearings ensure a smooth glide for the entire life of the slide
- Push to open - the precision activating mechanism opens the drawer automatically and in virtual silence - a light press is all it takes!
- Tool-free adjustment for **Height, Side, and Inset** depth. Optional rear tilt bracket is also tool-free.
- Self-cleaning ball-bearing tracks
- Uses #6-58FPDT screws (sold separately)

10 pr/ctn.

Code	Size	Drawer Lengths, 4 sided drawer, 1/2" material (+1/2 - 3/8")	List/pr
9181220-21	13", 320mm	13-1/16"	\$ 59.63
9181224-25	15", 380mm	15-3/8"	61.35
9181232-33	19", 480mm	19-1/8"	83.21

Code	Description	Ctn	List
9218980	Front Fixing Clips: Includes LH/RH clips and 2 ea. spacers	10 pr.	\$ 3.65 /pr

9205924	Tilt Adjustment LH	100	1.24 /ea
9205925	Tilt Adjustment RH	100	1.24

### QUADRO IW20 & IW21 4D PUSH TO OPEN W/ SOFT CLOSE

Opens without handles, closes softly and silently



With this Push to Open set, drawers are easy to open without handles, gently and quietly closing again. Drawers can still be pulled open and soft closed.

With the synchronization bar, the system can be activated from the edges of large drawer fronts, even with narrow front panel reveals.

- Drawer can still be pulled open/ soft closed
- Reliable activation for wide drawers with synchronization bar
- Clips into place without the need for tools
- Internal cabinet width > 7-7/8" (200mm), minimal drawer front gap of 2.5mm
- For drawer lengths: 15" - 24"

#### Set Includes:

- (1) Push to Open Silent unit, left and right
- (1) Activator, left and right
- (2) Adapters for mounting synchronization bar



#### IW20 / IW21 4D Push to Open Silent Sets

Code	Wt. Range	Nominal Length (mm)	List/st
9246312	22 lbs.	250 - 350	\$ 57.47
9246315	44 lbs.	250 - 600	61.68
9246316	66 bs.	350 - 600	61.68

#### Synchronization Bar for Push to Open Sets

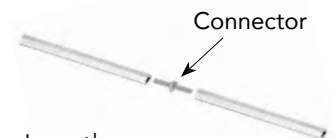

- 78-3/4" (2000mm) - Cut to Length
- Connector (sold separately) for minimizing offcut waste
- Recommended for cabinet widths of > 23-5/8" (600mm); can be used from 10-13/16" (275mm)
- Anodized aluminum, grey plastic
- 2D/4D bar length = Opening minus 7-7/8" (200mm)

Code	Description	List/ea
9236718	Synchronization Bar	\$ 22.85
9221295	Connector	2.46

# FLIPPER SLIDES

**KV**

## KV 8071 - FLIPPER SLIDES

Load Capacity: 30 lbs, Follower strip attached after slides are mounted in case.

8071 - No Hinges, Black Finish



Size	Length	Slide Travel	Approx. Door Conceal	Approx. Cab Depth
12	12-1/8"	7.46"	8"	12-3/8"
14	14-1/8"	9.46"	10"	14-3/8"
16	16-1/8"	11.46"	12"	16-3/8"
18	18-1/8"	13.46"	14"	18-3/8"
20	20-1/8"	15.46"	16"	20-3/8"
22	22-1/8"	17.46"	18"	22-3/8"
24	24-1/8"	19.46"	20"	24-3/8"

### Dimensions

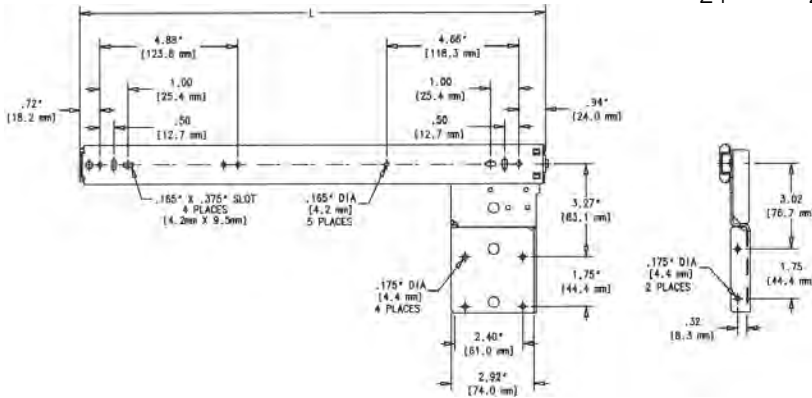

- Follower strip may be attached after slides are mounted in case.

### Installation

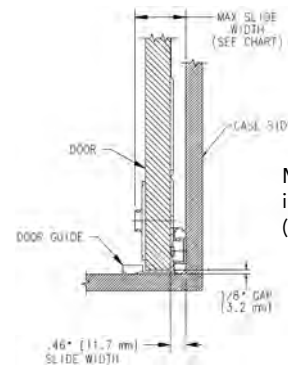
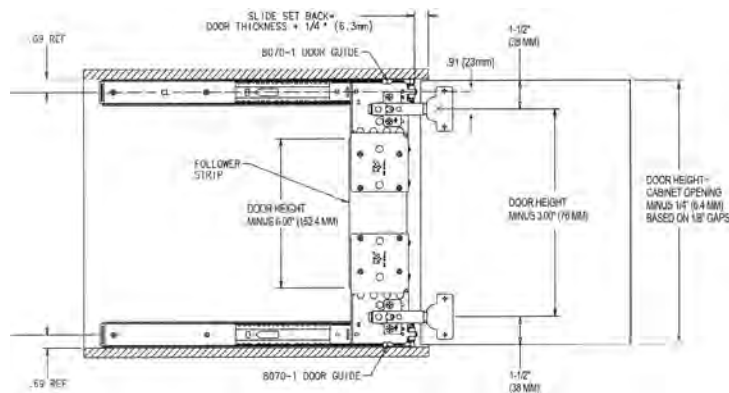

Max. slide width including hinge (chart 1)

### Salice Hinges (99 for Zinc color, 66 for Titanium color)

Code	Description	Door Thickness	Tab Distance	Cup Bore dia.	Max Width w/ hinge	Part. overlay
CFA7G99 (or 66)	Partial Overlay	3/4"	9/16"	35mm	1-21/32" (42.1mm)	3/8"
C2PBG99	Inset	3/4"	1/4"	35mm	1-21/32" (42.1mm)	N/A
CFA7G99 (or 66)	Inset	1"	5/16"	40mm	2-5/16" (58.7mm)	N/A
CFA7P99 (or 66)	Inset	1-1/4"	9/16"	40mm	2-5/16" (58.7mm)	N/A



**KV**

**FLIPPER SLIDES**

**KV 8071 POCKET DOOR SLIDES**

Load Capacity: 30 lbs.

Mounting: Mounts directly to cabinet side.

Load Rating: 30-Pound Class

Max. door dimensions: 42" H x 24" W

Finish: Ebony Black (EB) - Black. Zinc chromate electroplated with lacquer top coat.

Action: Progresssive movement on precision steel ball-bearings.

- Slides have been designed so that they index to cabinet top and side. Installer need only set back the slides 1/4" more than door thickness
- Follower strip bracket has been designed to allow the follower strip to be installed after slides are installed
- Metal ball retainer holds three bearings per inch of race for smooth and quiet operation
- Multiple hinge options allow for a wide variety of door applications - Inset, Free Swing, Overlay, Thick, and Extra-Thick

**Salice Hinges for 8071 Flipper**

CFA7G99 (or 66) - 3/8" Overlay, 3/4" door thickness

C2PBG99 - Inset, 3/4" door thickness

CFA7G99 (or 66) - Inset, 1" door thickness

CFA7P99 (or 66) - Inset, 1-1/4" door thickness

(99 for Zinc color, 66 for Titanium color)

Baseplate: BAR3R09 - Use with above hinges (or BAR3R06 for Titanium color)

**KV 8071 - Without Baseplates or Hinges**

Order 2 ea. hinges and 2 ea. plates per pair of slides. (See left column for hinges and plates) Polybagged with screws. Black finish.

Pack: 10 pr/Ctn.

<u>Code</u>	<u>Slide Length</u>	<u>Travel</u>	<u>Approx. Cab Depth</u>	<u>List/pr</u>
8071PEB-12	12-1/8"	7.46"	12-3/8"	\$ 58.44
8071PEB-14	14-1/8"	9.46"	14-3/8"	60.68
8071PEB-16	16-1/8"	11.46"	16-3/8"	63.64
8071PEB-18	18-1/8"	13.46"	18-3/8"	62.90
8071PEB-20	20-1/8"	15.46"	20-3/8"	62.87
8071PEB-22	22-1/8"	17.46"	22-3/8"	63.78
8071PEB-24	24-1/8"	19.46"	24-3/8"	65.23

**KV ROLLERS for 8071/8072**



8090P-CR

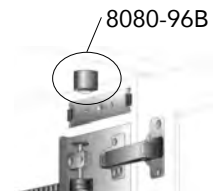

8080-96B

<u>Code</u>	<u>Description</u>	<u>List/ea</u>
8090P-CR	Cassette Roller	\$ 9.21
8080-96B	Spare Guide Roller	.91



# FLIPPER SLIDES

KV

## KV 8091 FLIPPER SLIDE

Heavy Duty, Load Capacity: 75 lbs.

Finish: Ebony Black (EB) - Black. Zinc chromate electroplated with lacquer top coat.

Action: Progressive movement on precision steel ball-bearings. Extension: 3/4.

## 4 X 4 RACK & PINION SYSTEM

4 Hinges and 4 Track Wheels per Door

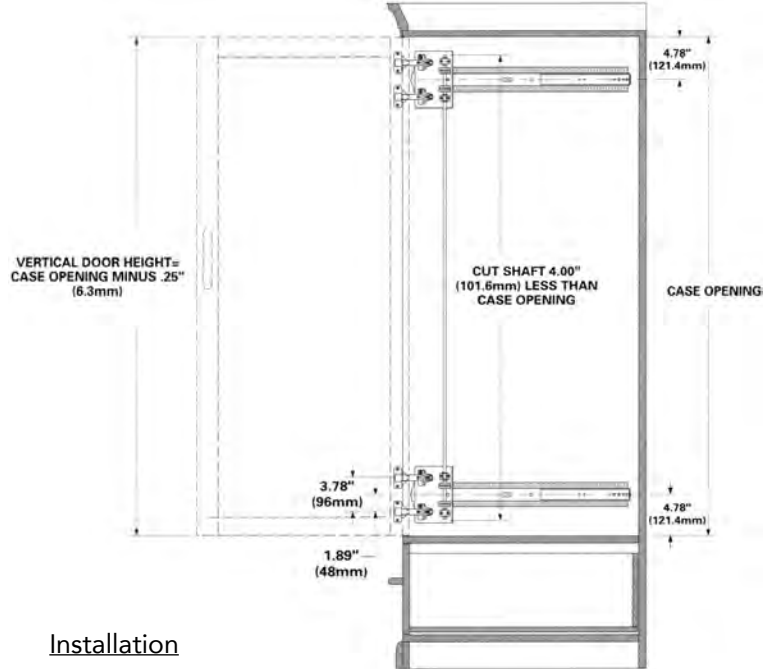
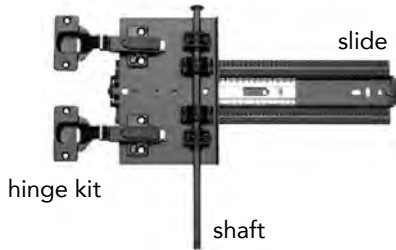

Dual rack and pinion system virtually eliminates door sag.

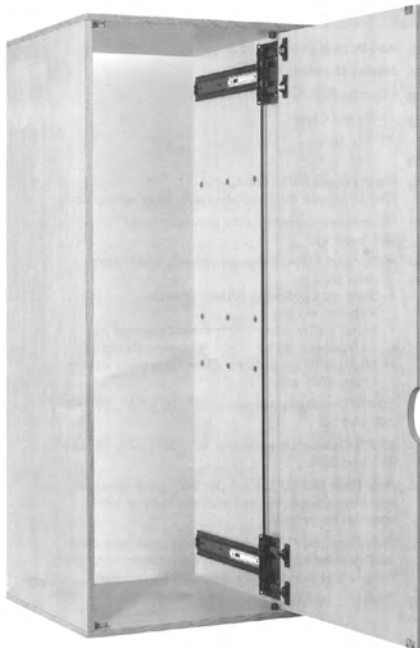

### Installation

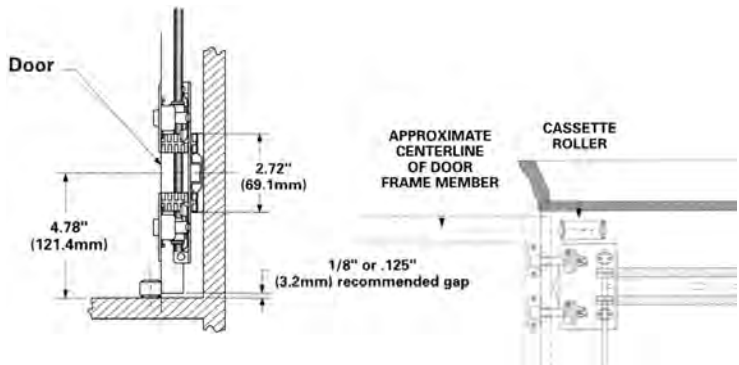

### Dimensions

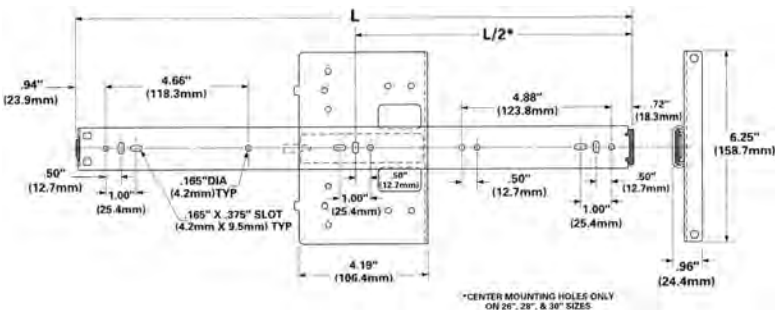

Size	L	L/2*	Approx. Door Conceal**	Approx. Cabinet Depth***
18"	18-1/8"	-	14"	18-3/8"
20"	20-1/8"	-	16"	20-3/8"
22"	22-1/8"	-	18"	22-3/8"
24"	24-1/8"	-	20"	24-3/8"
26"	26-1/8"	13-1/16"	22"	26-3/8"
28"	28-1/8"	14-1/16"	24"	28-3/8"
30"	30-1/8"	15-1/16"	26"	30-3/8"

\*Center mounting holes only on 26", 28", & 30" sizes

\*\* Door fully retracted into case

\*\*\* Add thickness of door to determine minimum



**KV**

**FLIPPER SLIDES**

**KV 8091 POCKET DOOR SLIDE**

Mounting: Mounts directly to cabinet side

Load Rating: 75 lb Class

Max. Door Dimensions: 72" H x 26" W

Finish: Ebony Black (EB) - Black. Zinc chromate electroplated with lacquer top coat

Action: Progressive movement on precision steel ball bearings. Extension: 3/4.

**Additional Features**

- Dual rack and pinion system virtually eliminates door sag
- 75 Pound Class rated for heavy duty applications
- Maximum door dimensions: 72" H x 26" W
- Innovative indexing pin allows door slide to nest within door rack for easy alignment and installation
- Self-closing, three-way adjustable isometric door hinge
- Allows installer to use the hinge/plate of their choice
- Precision steel ball bearings provide smooth and quiet operation

**Hinges & Plates for 8091:**

Salice C2RBG66 with BAR3R36 plate for standard inset. See following pages for other overlays, thick door, etc.

**Full Overlay Kit**

8091FULL3/4S	Kit includes Salice hinges and all hardware needed to do a full overlay on a 3/4" door (see page 1568)	List/kit \$ 96.59
--------------	--	----------------------

**KV 8091 - Without Baseplates or Hinges**

Order 4 ea. hinges and 4 ea. plates per pair of slides (see next page for hinges and plates). Polybagged with screws. Order shafts separately. Black finish.

Pack: 5 sts/Ctn. (1 set per door)

<u>Code</u>	<u>Slide Length</u>	<u>Travel</u>	<u>Approx. Cab Depth</u>	<u>List/pr</u>
8091PEB-12	12-1/8"	8"	12-3/8"	\$ 155.15
8091PEB-14	14-1/8"	10"	14-3/8"	158.48
8091PEB-16	16-1/8"	12"	16-3/8"	191.58
8091PEB-18	18-1/8"	14"	18-3/8"	158.50
8091PEB-20	20-1/8"	16"	20-3/8"	166.40
8091PEB-22	22-1/8"	18"	22-3/8"	166.87
8091PEB-24	24-1/8"	20"	24-3/8"	166.88
8091PEB-26	26-1/8"	22"	26-3/8"	167.29
8091PEB-28	28-1/8"	24"	28-3/8"	181.37
8091PEB-30	30-1/8"	26"	30-3/8"	172.52

**SHAFTS for 8091**

<u>Code</u>	<u>Description</u>	<u>List/pr</u>
8092SBEB-36	36" Pinion Shaft	\$ 16.85
8092SBEB-48	48" Pinion Shaft	28.44
8092SBEB-72	72" Pinion Shaft	45.84

**ROLLERS for 8091**

<u>Code</u>	<u>Description</u>	<u>List/ea</u>
8090P-CR	Cassette Roller	\$ 9.21
8080-96B	Spare Guide Roller	.91



**KV 8091 – Packed Without Baseplates or Hinges**

Order 4 each hinges and 4 ea. baseplates per pair of slides (Titanium finish is specified below). Order shafts separately.

**Hinges for 8091 OVERLAY DOORS**

<u>Door Thickness</u>	<u>Hinge (40mm)</u>	<u>Plate</u>	<u>Tab</u>	<u>Overlay**</u>	<u>Protrusion</u>
3/4"	CFA7G66	3mm BAR3R36	9/16"	1/4" max	1-7/8"
13/16"	CFA7G66	3mm BAR3R36	9/16"	1/4" max	1-7/8"
7/8" (max)	CFA7G66	6mm BAR3R66	9/16"	1/8" max	2"

**Hinges for 8091 INSET DOORS**

<u>Door Thickness</u>	<u>Hinge</u>	<u>Plate</u>	<u>Tab</u>	<u>Notes</u>
3/4 - 13/16"	C2RBG66 (35mm)	3mm (BAR3R36)	3/8"	Front hole 1-7/8" back from case front
7/8"	CFA7G66 (40mm)	6mm (BAR3R66)	3/8"	Front hole 2-1/8" back from case front
1"	CFA7G66 (40mm)	9mm (BAR3R99)	1/2"	Front hole 2-1/4" back from case front
1-1/4"	CFA7P66 (40mm)	0mm (BAR3R06)	9/16"	Front hole 2-3/8" back from case front

**FULL OVERLAY KIT**

<u>Door Thickness</u>	<u>Hardware Kit</u>	<u>Description</u>
3/4"	8091FULL3/4S	Use with the 8091 Flipper Door to provide Full Overlay on doors up to 3/4" thick.

See Next Page for Details

## FLIPPER SLIDES ACCESSORIES

### KV FULL OVERLAY KIT

for 4x4 Pocket Doors

The KV Full Overlay Bracket Kit has been designed to provide a full overlay on doors up to 3/4" thick. The specialized mounting bracket is easily attached to the 4X4 Pocket Door system and does not compromise the operating characteristics for the KV 8091 series product.

A partition will need to be built into the cabinet. The overlay kit attaches to the slide and the slide is installed on the partition.

Partition Width = 1" (25.4mm) plus Door Thickness

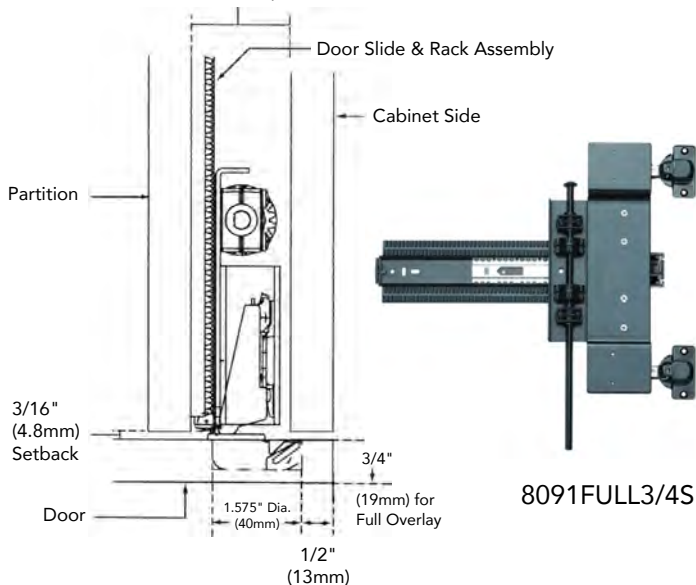

8091FULL3/4S

- Provides a full overlay on doors up to 3/4" thick
- Attaches easily to KV 8091 4X4 Pocket Door System
- Will not compromise the performance features of the 4X4 Pocket Door System

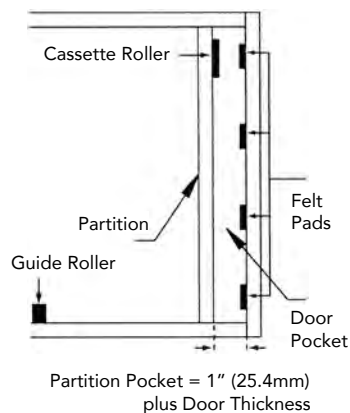

Polybagged kit contains: 2 brackets, 4 Overlay Hinges, 4 Plates, 4 Hinge Cover Caps, 4 Protective Door Felt Pads and all necessary mounting hardware. 6 kits per carton.

Code	Description	List/kit
8091FULL3/4S	Full Ovly Kit w/Salice Hinges	\$ 96.59

### CASSETTE ROLLER AND GUIDE ROLLERS FOR KV 8091/8092 POCKET DOOR SLIDES

8080-96B  
 Guide Roller

8090P-CR  
 Cassette Roller

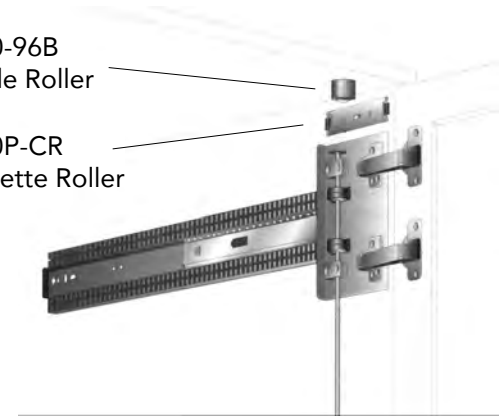

Approximate centerline of door frame member

Cassette Roller

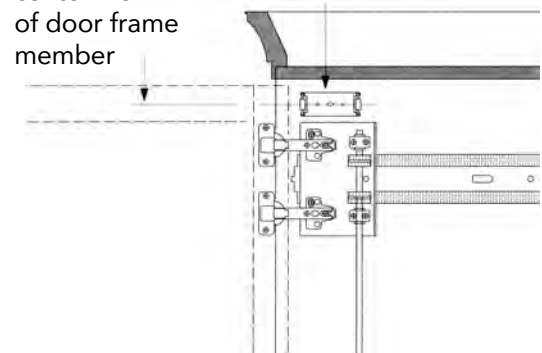

The 8090P-CR Cassette Roller installs easily to give your doors extra protection when using pocket door slides. The cassette roller installs anywhere in the case to insure that the rails of the door will not rub against the pocket door hardware. (Other brands allow rollers to be mounted only at the top and bottom of case.)

The 8080-96B guide roller keeps doors properly aligned. (Note: Guide rollers are included with the 8091/8092 pocket door slides.)



8090P-CR

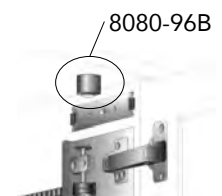

8080-96B

Code	Description	List/ea
8090P-CR	Cassette Roller	\$ 9.21
8080-96B	Guide Roller (w/ screw)	.91



# FLIPPER DOOR

## UPWARD OPENING FLIPPER DOOR MECHANISM

Sugatsune IF - Soft Close

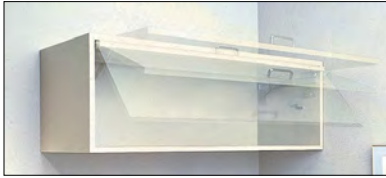

IF-360W

- For upward-opening cabinet doors
- Soft closing prevents slamming and speed is adjustable
- Door pockets into the cabinet to get out of the way when opened, also allowing other cabinets to be installed on top

### Specs

Torque (lbs - in): 34 - 121 lbs.  
 Door Weight (lbs): 5.9 - 11 lbs.  
 Max Door Width (in): 47-1/4"  
 Door Thickness (in): 19/32" - 13/16"

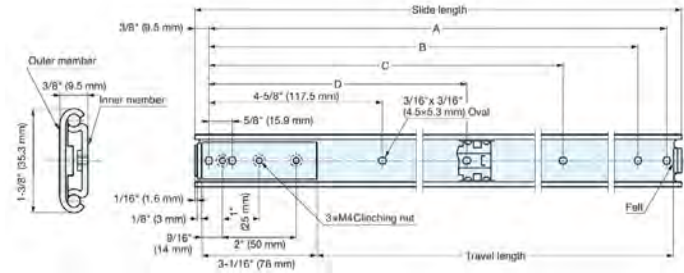

Code	Slide Length	Travel Length	A	B	C	D
IF-360W-14	14"	10-9/16"	13-1/4"	12-5/8"	8-5/8"	-
IF-360W-16	16"	12-9/16"	15-1/4"	14-5/8"	10-5/8"	-
IF-360W-19	19"	15-9/16"	18-1/4"	17-5/8"	13-5/8"	9-1/8"
IF-360W-24	24"	20-9/16"	23-1/4"	22-5/8"	18-5/8"	11-5/8"

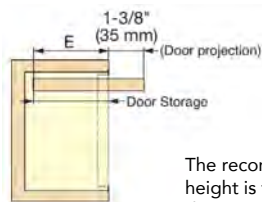

\*\*E = Door Storage

The recommended door height is that when the door protrudes 1-3/8" from cabinet with door stored as shown.

Code	Description	List/ea
IF-360W-14	Flipper Slide, 14"	\$ 177.00
IF-360W-16	Flipper Slide, 16"	192.00
IF-360W-19	Flipper Slide, 19"	212.00
IF-360W-24	Flipper Slide, 24"	227.00

# APPLIANCE LIFTS

## REV-A-SHELF HEAVY DUTY-MIXER LIFT



The heavy-duty chrome mixer lift can be attached to any custom made shelf and therefore will fit all cabinet sizes. The RAS-ML-HDCR features built-in shock dampeners, adjustable spring tension and holds appliances up to 60 lbs.

Also available Soft-Close.

RAS-ML-HDCR

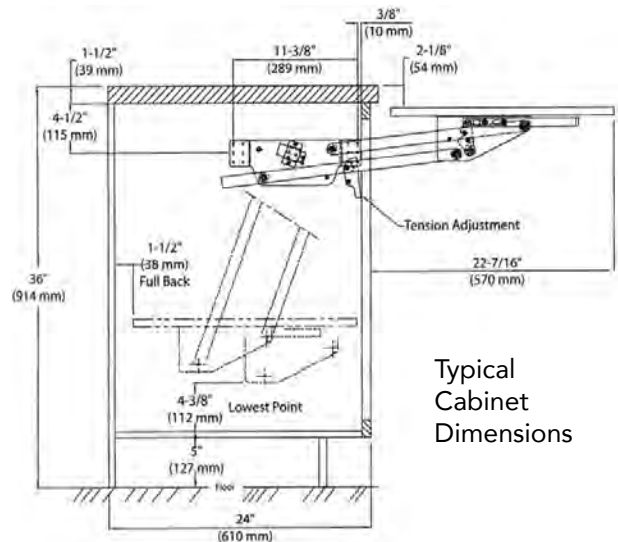

Typical Cabinet Dimensions

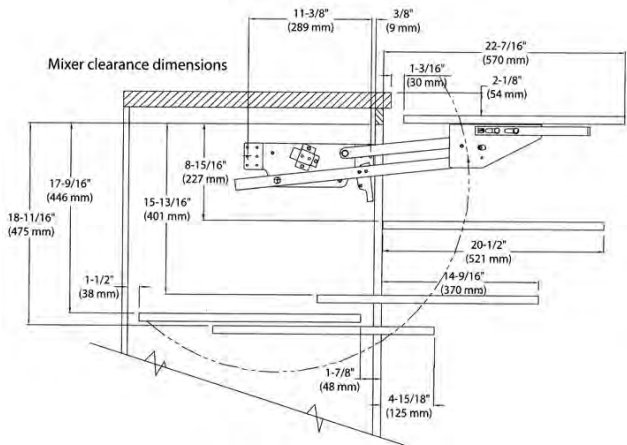

Code	Description	List/ea
RAS-ML-HDCR	Chrome Mixer Lift	\$ 176.48
RAS-ML-HDSC	Soft-Close Chrome Mixer Lift	322.62



## SHELF SLIDES

### SALICE SHELF SLIDE

Soft Close, Full Extension

- Dynamic load cap: 66 lbs.
- Soft Closing



- Safety system that prevents the shelves from turning over
- A710 clip: Shelf height adjustment +2.5 mm
- A750 clip: Shelf height adjustment +2.5 mm, side adjustment ±1.5 mm, depth adjustment ±2 mm
- Finish: bright zinc-plated

825650000 Support



### Support for the rear hook

With shelves of reduced thickness (MDF or particle board), min.12 mm, the runner can be used together with the support for the rear hook, thus eliminating the need for the rear hole in the shelf.

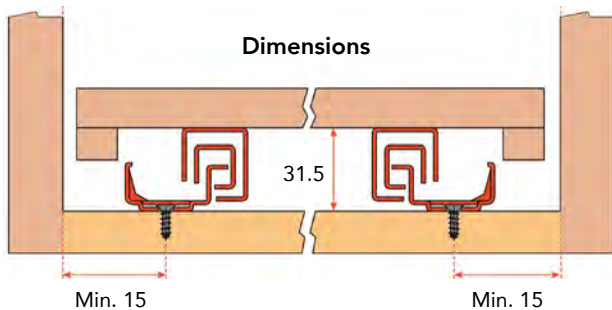

Code	Description	Ctn	List
A65559-14	14" Shelf Slide	6	\$ 45.63/pr
A65559-16	16" Shelf Slide	6	46.98
A65559-18	18" Shelf Slide	6	50.28
A65559-20	20" Shelf Slide	20	52.11
A65559-22	22" Shelf Slide	6	56.47
A65559-24	24" Shelf Slide	6	54.98
A710.610	Front Clips	100	2.55
A750.010	Front Clips w/ 6 way adjustment	100	7.69
825650000	Rear Hook Support	200	.73/ea

### KV 8407 PULL-OUT SHELF SLIDE

Full Extension, Load Capacity: 100 lbs.



**8407**

**100 lbs.**

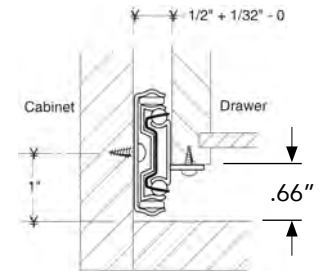
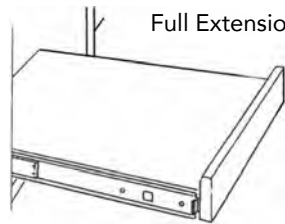

- 32mm hole pattern
- Tab disconnect for easy drawer removal
- Ball retainer latch and ramps for easy drawer insertion
- Flexible mounting tabs self-adjust to side clearance
- 3 ball-bearing per inch of race
- Polymer stop cushions

**Mounting** Bottom and side-mountable in frame and frameless construction. Tray or drawer sits on shelf tabs and is secured with screws.

**Height** 1-13/16" (1.8")

**Side Clearance** 1/2" plus 1/32" minus 0" each side

**Load Rating** 100 lbs.

**Finish** Anochrome (bright zinc chromate electro-plated with a lacquer top coat)

**Action** Telescoping, full-extension on precision steel ball-bearings. Tray or drawer sits on shelf tabs and is secured with screws.

Pack: 10 pr/Ctn. (Screws not included)

Code	12"	14"	16"	18"
8407B-	\$ 34.06	34.24	35.42	36.03
	20"	22"	24"	
	36.78	38.08	39.42	

## PANTRY SLIDES

### KV 8000 PULL-OUT PANTRY/TV SLIDE

Load Capacity: 130 lbs/pr.

**8000**

**130 lbs.**



Can be used for pull-out pantries in kitchens, TV shelf or other entertainment components. Mounts under shelf and can be completely concealed with shelf skirt. Features removable brackets that allow for fast and easy installation.

Has closed position hold-in detent and over-travel for door clearance. Positive stop in extended position.

Clearance: 3/4" Slide only, 2-1/4" with brackets.

Load Capacity: 130 lbs/pr.

Travel: Slide Length + .83"

Height: 1.54"

Finish: Anochrome

Action: Telescopic

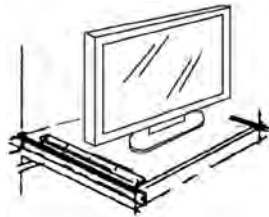

Use as a TV Pull-Out Slide

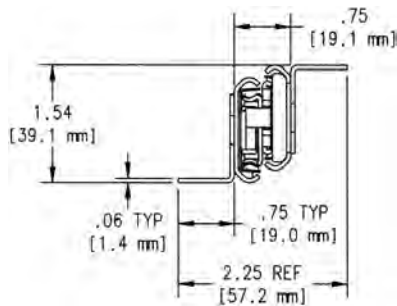

Code	Travel	Ctn	List/pr
8000P-14	14.83"	5	\$ 102.81
8000P-16	16.83"	5	103.91
8000P-18	18.83"	5	106.06
8000P-20	20.83"	5	112.84
8000P-22	22.83"	5	120.36
8000P-24	24.83"	5	113.65
8000P-26	26.83"	5	116.82

Slide Length	Slide Travel	A	B	C
12.00	12.83	4.00	6.00	10.00
14.00	14.83	4.00	8.00	12.00
24.00	24.83	7.00	15.00	22.00
26.00	26.83	7.00	17.00	24.00

**Note:** Mounting holes, slide height, slide width, slide travel and weight capacity match the 301-2590 exactly.

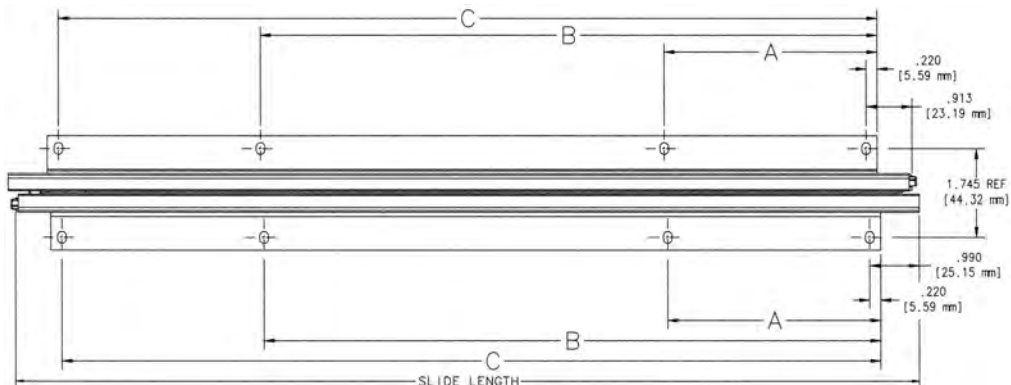

15



## PANTRY SLIDES

### FULTURER FR771 HEAVY DUTY PANTRY SLIDE

For Wood Pull-Outs, Full extension, Progressive Action  
Integrated Easy Close Device, Load Capacity: 275 lbs.



The top slide has an adjustable out-stop to compensate for various loads.



**FR771**

**275 lbs.**

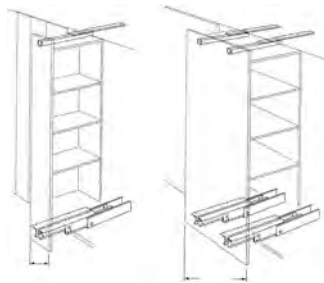

For cabinets taller than 72" (1800mm)

Up to 18" (450mm) width one slide is recommended. Over 18" width two slides are recommended.

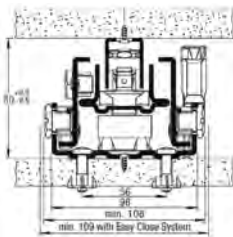

bottom slide

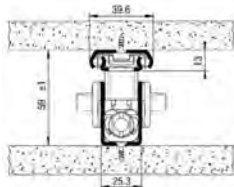

top slide

Material: Powder coated cold rolled steel  
Bearing material: High-grade Delrin roller ball-bearings  
Load capacity: Dynamic up to 275 lbs. per slide set  
( 2 slide sets = 550 lbs.)

Low height profile. Easy Close Device (ECD) integrated (top and bottom slide). "Clean" appearance. Smooth and quiet progressive movement. Patented middle profile counteracts any deflection when loaded. Horizontal and parallel end position without play. Top adapter plate for wooden platform attachment.

Applications: pantries, archives, tool storage, home entertainment systems, etc.

One set = One slide with one top guide.

Code	Size	Ext. Loss	List/set
FR771-575	22-5/8"	12mm	\$ 402.53

### FULTURER FR777A HEAVY DUTY PANTRY SLIDE

For Wood Pull-Outs, Full extension, Progressive Action  
Load Capacity: 450 lbs.



**FR777A**

**450 lbs.**



Super Heavy Duty Pantry Slide. Good for any massive weight storage, including wide TV or to pull an entire entertainment cabinet out of the wall to access connections. Easy Close device (ECD) is available (order separately).

Full extension with no deflection noiseless movement, back stop, integrated lateral and height adjustment, 32mm system capability and sealed bearings – no lubrication needed. Top guide insures absolute lateral stability. LGA tested according to DIN 4554 standard at 50,000 cycles. Steel, white powder coated.

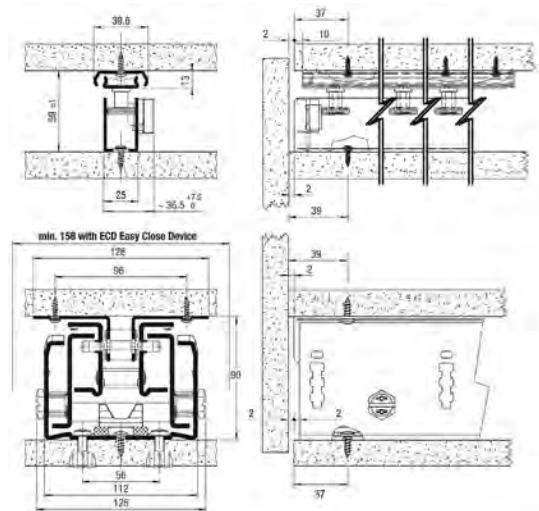

Code	Description	List
FR777A-500	Pantry Pull-Out, 20" (500mm)	\$ 750.00
FR777A-550	Pantry Pull-Out, 22" (550mm)	954.00
7719	Soft-Close Device	160.00



## KEYBOARD SLIDES

### KV 8150 KEYBOARD SLIDE

Adjustable Height, Load Cap: 75 lbs.



**8150**

- Tab Disconnect
- Hold-in/Hold out Detent

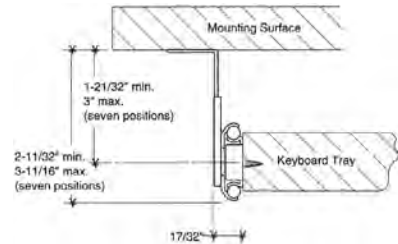

**Height:** Overall drop height is adjustable from 2-11/32" to 3-11/16" in 7/32" increments. Cabinet members must be mounted parallel to each other and perpendicular to case front.

**Clearance:** Width of slide with brackets in outboard position is 1-5/8" per side. Width of slide with brackets in inboard position is 5/8" per side.

Medium duty, 3/4 extension steel ball-bearing slide, with adjustable mounting brackets. 75 lb. load rating. Cabinet members mount to underside using adjustable brackets. Inner members mount to keyboard tray. Mounting brackets adjust to 7 different heights and can be reversed for inboard or outboard mounting.

15 Cushioned in stops and out stops for quiet action. Friction detent for stay-close and hold-open. Tab disconnect. WIC Approved.

Polybagged w/ screws, 10 bags/Ctn.

Code	Description	List/pr
8150P-14	Anochrome, 14"	\$ 42.53
8150P-16	Anochrome, 16"	43.86
8150P-18	Anochrome, 18"	44.78
8150PEB-16	Ebony Black, 16"	46.01
8150PEB-18	Ebony Black, 18"	46.94
8150PEB-20	Ebony Black, 20"	49.00

### FULTERER 5060

Load Cap: 75 lbs. Dynamic

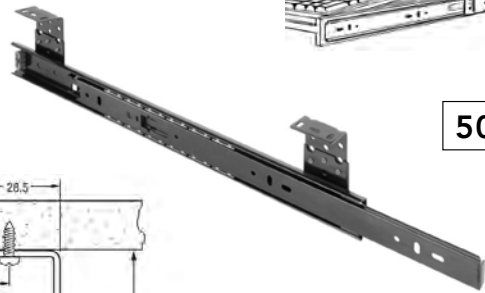
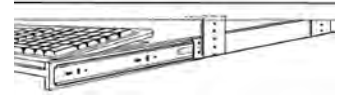

**5060**

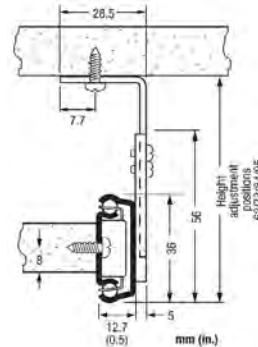

- Hold-in and Hold-out detent with positive out-stop.
- Four position adjustable mounting brackets vary height at 2.4", 2.83", 3.3" and 3.75".
- Tab disconnect is easy to use.

For computer keyboards and writing shelves. Has hold-in and hold-out detent. Smooth, all ball-bearing action. Four height positions with pre-tapped holes. Easy to use tab disconnect. Inboard/outboard bracket positioning. Available in black chromate.

10 pr/box.

Black	14"	16"
5060BL-	\$ 38.16	33.58

### HOUCK BREADBOARD SLIDES

13/16" channel to accommodate 3/4" board

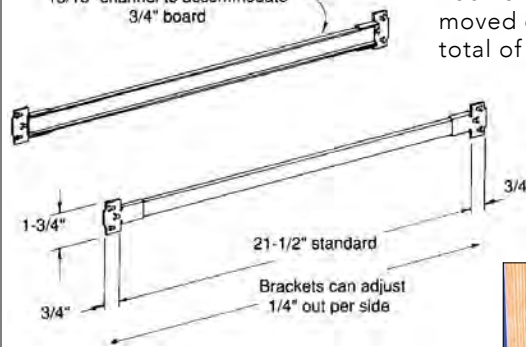

Each bracket may be moved out 3/8" for a total of 3/4" extension.



Side Mounted. 50 sets/Ctn.

Code	Description	List/set
BB SLIDE	Breadboard slides, 30 lbs/st	\$ 9.52



## KEYBOARD ARMS

### KV / WATERLOO KEYBOARD ARM

**6733M16**

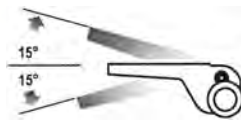

Tray Bracket Articulating Range

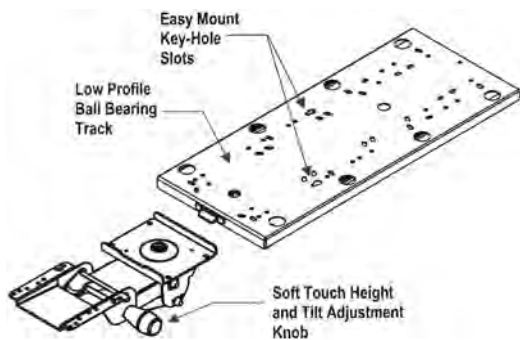

#### HEIGHT ADJUSTMENT 6.2" [158mm] Vertical Travel

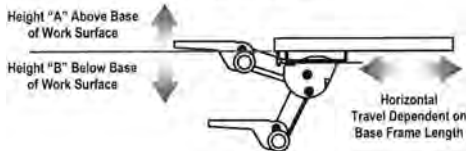

Height  
A = 1.2"  
B = 5.0"

Includes platform  
(tray) 6421D.



The 6733M16 Keyboard Arm has an overall dimension of 7.5" W x 14.5" L. Low profile precision ball-bearing storage track is 16". Black in color. Load capacity: 100 lbs.

Features: Soft touch knob for simultaneous adjustment of both height and tilt. Spring assisted to help counterbalance keyboard tray weight. Low profile design for maximum leg room. 360° swivel allows user to move keyboard freely from side to side. Stores on a low profile ball-bearing track with universal mounting hole pattern. Includes universal tray mounting bracket and platform (tray) 6421D.

Code	Description	List/ea
6733M16	Keyboard Arm w/ Platform included	\$ 264.10

### KV / WATERLOO FULLY ARTICULATED KEYBOARD ARM

With Height Adjustment Knob

**6130D**

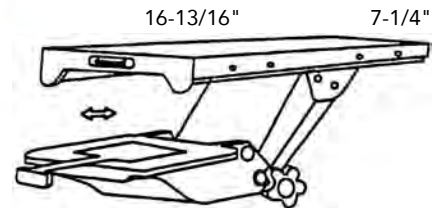

Low profile design. 6" Height Adjustment with knob control. 16-13/16" length ball-bearing slide storage feature. Hold-out lock. 15° Adj. Tilt: 10° forward, 5° backslope. Full 360° arm rotation. Accepts 6500 & 6200 series optional tray. Meets BIFMA standards. Black in color.

Code	Description	List/ea
6130D	Keyboard Arm w/ Height Adjustment Knob	\$ 189.33

### KV / WATERLOO FULLY ARTICULATED KEYBOARD ARM

With Height Adjustment Lever Lock

**6170D**

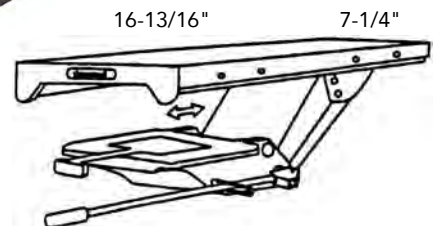

All of the same features as the 6130D (above), except with lever height adjustment.

Code	Description	List/ea
6170D	Keyboard Arm w/ Lever Height Adjustment	\$ 198.18





## KEYBOARD ARMS/TRAYS

### COMPATIBLE KEYBOARD ARMS AND TRAYS

Workrite Trays C180, C185	all work with	Arms 29155-2, 22805, 6130D, 6170D, 6733M16
KV/Waterloo Trays 6501D		Arms 4461D (Slide)
6421		6130D, 6170D, 6733M16
Weber Knapp Trays 26642-2		Arms 29155-2, 22805

### WEBER KNAPP KEYBOARD MICRO-ARM

Keyboard Support Mechanism



**29155-2**

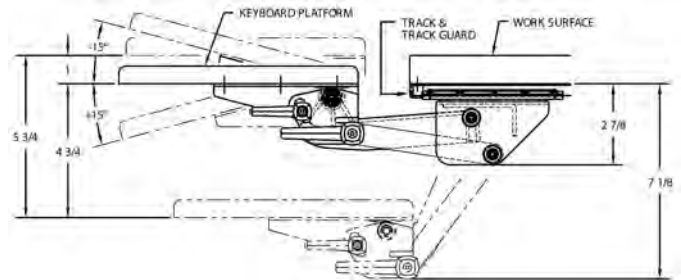
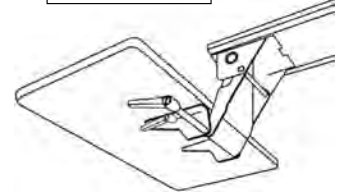

This Retractable Keyboard Micro-Arm is compact, lightweight and easy to use. It features both height and tilt adjustment set by independent ratchet handles. Install the retractable Micro-Arm where the keyboard is only part of the workstation's function. Slides completely out of sight, swivels, lifts and lowers to the user's preference. Locks firmly into place. Single track design for simple installation.

- Up/Down: 5-3/4"
- Tilt: +/- 15°
- 360° Rear Swivel
- Track: 17-3/4"
- Rugged steel construction
- Black powder coat finish
- Mounting hardware and instructions included

### Optional Keyboard Platform

Platforms are pre-drilled to mount securely to any Weber Knapp keyboard arm. Features wood construction with a durable, stain resistant black vinyl covering, providing a non-skid work surface. Includes Mouse Pad.

26642-2



10-1/2" x 21-3/4" x 5/8" thick

### WEBER KNAPP KEYBOARD SUPPORT ARM

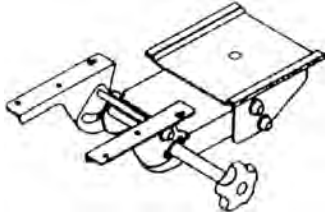

**22805**

Fully Adjustable



- Up/Down: 5-3/4"
- Tilt: +/- 15°
- 360° Rear Swivel
- Track: 17-3/4"

Single knob for tilt and height adjustment. Takes Workrite drill pattern. 32mm centers. Infinite adjustments between height and tilt range.

Code	Description	List/ea
22805	Support Arm, Black	\$ 94.48
26642-2	Keyboard Platform, Black	60.00

Code	Description	List/ea
29155-2	Retractable Mini-Arm	\$ 84.21
26642-2	Keyboard Platform, Black	60.00



## KEYBOARD PLATFORMS

### KEYBOARD PLATFORM W/ PALM REST

Workrite

**C180**

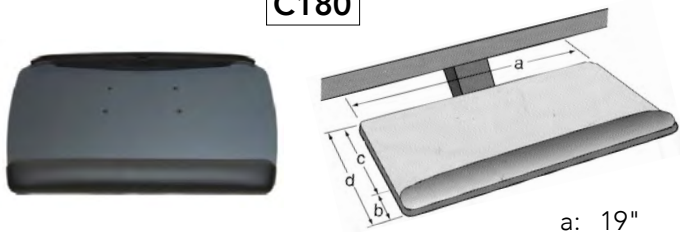

- a: 19"
- b: 2-1/2"
- c: 9"
- d: 11-1/2"

19" wide keyboard platform with comfortable built-in LeatherRite palm rest.

Code	Description	List/ea
C180	Keyboard Platform, Black	\$ 105.64

### KEYBOARD TRAYS

KV/Waterloo

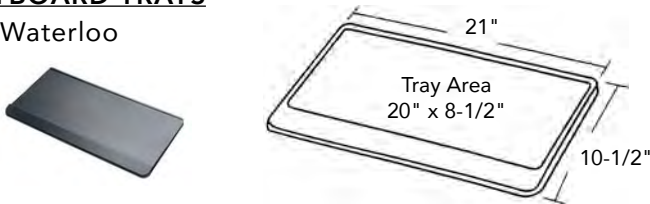

**6501D**

Made of durable molded polymer. Mounting holes provided.

Size: 10-1/2"D x 21w"W.

Code	Description	List/ea
6501D	Keyboard Tray, Black	\$ 68.28

### KEYBOARD TRAY w/ MOUSE TRAY

KV/Waterloo

**6421D**

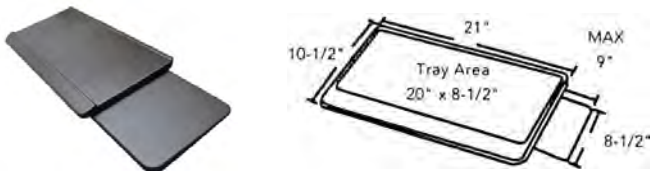

Keyboard Tray (plastic) with Sliding Mouse Tray (hard polymer MDF). Mouse tray slides left or right. For use with 5900 & 6100 Series Keyboard arms.

Code	Description	List/ea
6421D	Keyboard Tray w/ Mouse Tray, Black	\$ 80.09

### KEYBOARD/MOUSE PLATFORM W/ REST

Workrite

**C185**

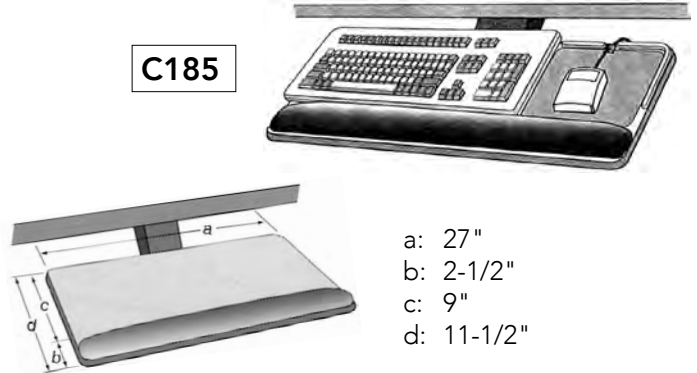

- a: 27"
- b: 2-1/2"
- c: 9"
- d: 11-1/2"

Combination Keyboard/Mouse platform with comfortable padded LeatherRite palm support.

Code	Description	List/ea
C185	Keyboard/Mouse Tray, w/ palm support, Black	\$ 188.45

### KV / WATERLOO CPU HOLDER

**7351D**



Vertically mounts to the underside of work surface or to an end gable. Self-locking, ratchet style storage device. 16 gauge steel construction. Supports up to 85 lbs. Black finish. 360° swivel.

Height adjustment: 13.5" - 22.5"

Width adjustment: 3.5" - 9.3"

Code	Description	List/ea
7351D	CPU Holder	\$ 135.24



## KEYBOARD TRAYS

### **KV KD1000 KEYBOARD DRAWER**

With integral mousing surface & palm rest



**KD1000**

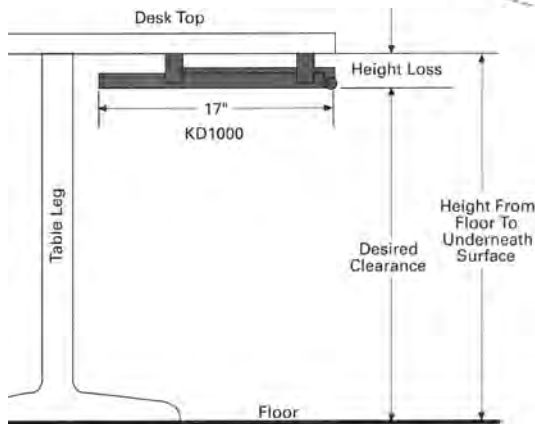
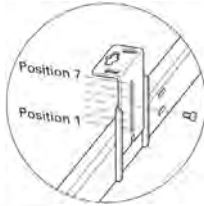

Brackets mount in "outboard" position under work surface for application widths 29" or greater, and in the "inboard" position for widths greater than 26.75".

Height Adjustment: 7 positions 2.25" - 3.60"

Height Loss Under Surface (inches): 7 positions 2.43 - 3.78

Minimum Space Requirements: 28" wide x 17" deep x 2-1/2" high

Tray Size (inside): 25.75" x 10".

Load Capacity: 75 lbs. Finish: Black.

Action: Steel ball-bearing slides with lockout.

Slide Travel: 11-7/8"

Cushioned Lycra Gel wrist rest is 28-3/4". Plastic bumper wraps around the front edges of drawer. There is an integral ambidextrous mousing surface inside tray.

<u>Code</u>	<u>Description</u>	<u>List/ea</u>
KD1000	Keyboard Drawer	\$ 202.06

Note: KV keyboards provide more knee space, since they are almost 2" thinner. They will also fit into narrower width openings.

## DRAWER SLIDE SPACERS

### DRAWER SLIDE SPACERS

For drawers and pull-out shelves. White or Almond plastic, sturdy and economical. For 3/4 and Full Extension. Locator pin for 5mm line bore.

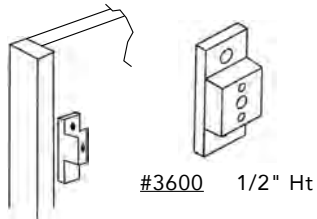
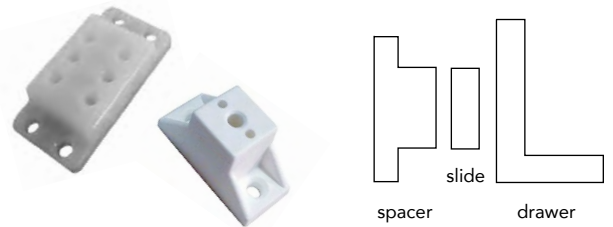

#3600 1/2" Ht



#3682 3/4" Ht  
 #3602 1" Ht  
 #3604 1-1/4" Ht  
 #3608 1-1/2" Ht



#3603 1-7/16" Ht  
 Slide Out Tray Spacer

#### Undermount drawer slide spacer

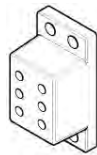

#3639 1-3/4" Ht  
 #3643 1-1/2" Ht  
 #3633 1-1/4" Ht  
 #3640 1" Ht  
 #3652-32 5/8" Ht

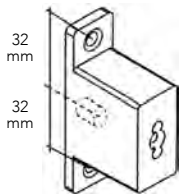

#3615 1-5/8" (42mm) Ht  
 For use on full ext. slides

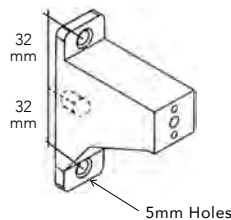

#3613 2-3/16" Ht  
 For pullout shelves

Code	Description	Ctn	List/C
3600	White, 1/2" Ht	1000 ea.	\$ 33.49
3682	White, 3/4" Ht	1000	34.01
3602	White, 1" Ht	1000	52.05
3603	White, 1-7/16" Ht	100	56.63
3604	White, 1-1/4" Ht	1000	75.77
3608	White, 1-1/2" Ht	500	58.95
3613	White, 2-3/16" Ht	1000	189.19
3615	White, 42mm Ht	100	95.39

Code	Description	Ctn	List/ea
3633WH	White, 1-1/4" Ht	100 ea.	\$ 3.37
3633AL-32	Almond, 1-1/4" Ht	100	2.37
3643WH	White, 1-1/2" Ht	100	3.06
3640WH	White, 1" Ht	500	1.93
3640AL	Almond, 1" Ht	100	3.05
3652-32	White, 5/8" Ht	100	1.79
3652AL-32	Almond, 5/8" Ht.	100	1.79
3639-32	White, 1-3/4" Ht	100	3.24
3639AL-32	Almond, 1-3/4" Ht	100	3.01

### Problem:

Pullout shelves behind cabinet doors can damage door backs and interfere with door hinges.

### Solution 1:

Use *drawer slide spacers* to offset rollout shelf slides. Shelf rolls past standard hinge at standard height on door. Allow approximately 7/8" for 120° hinge. If face frame is used, select spacer to clear frame as well.

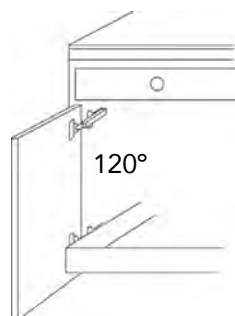

Mount to end panel with system screw or truss head

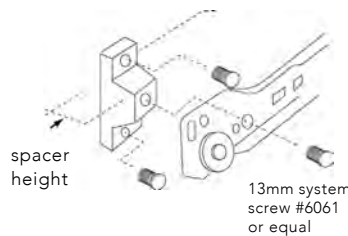

Pre-attach to guide at front and back or use 3 spacers for larger rollouts (there are plenty of holes)

**NOTE:**  
 You may want to use a different hole in guide if rollout is at same height as hinge.

### Solution 2:

Use wide angle 165° zero-protrusion hinge location to miss pullouts.

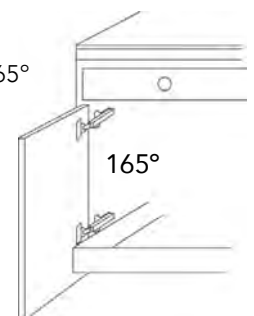



## FILE HANGERS

### FILE HANGERS & CLIPS

Allows Both Letter & Legal Size Filing in Same Drawer!

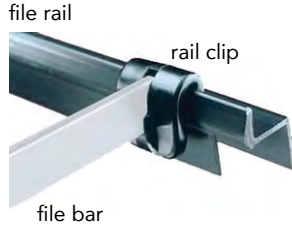

File Clip clinches to extruded File Rail. Allows for both letter and legal size filing in the same drawer. For rail application on false front drawers, simply trim rail overhang and staple. Powder coated steel.

Possible File Drawer Configurations

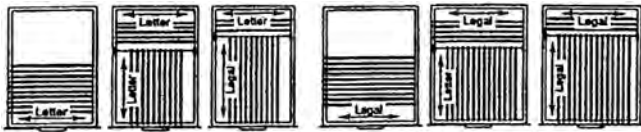

↑ Front (use clips for alternative filing options)

Lateral File Drawers

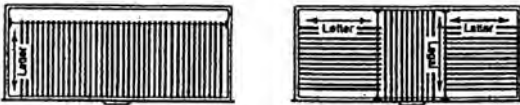

↑ Front

Code	Description	Color	Ctn	List/ea
CPF312500	Hanging File Rail, 1/2", 8.2'	Black	100	\$ 11.63
2309WH-4	Hanging File Rail, 1/2", 4'	White	60	7.50
2309-58-WH	Hanging File Rail, 5/8", 8'	White	100	15.44
6001BK	File Rail Clip	Black	100	.74
6001WH	File Rail Clip	White	100	1.03

## FILE BRACKETS

### HANGING FILE BRACKETS

Standard, Top Mount & Side Mount

KHFB Standard Mount

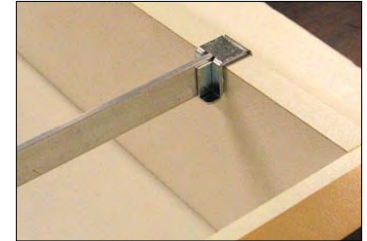
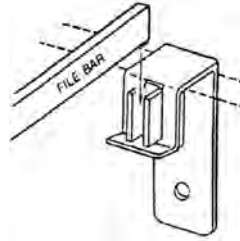

KHFB-TM Top Mount

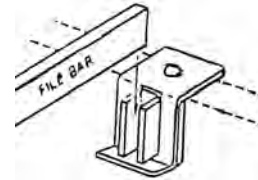

KHFB-SM Side Mount

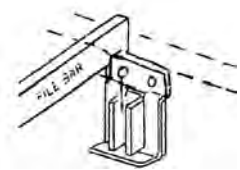

Hanging file brackets are 16-gauge steel and will hold the heaviest files. No cutting or grooves - quick to install! Holds 1/8" thick file bars. Fits 1/2" drawer sides. For thicker drawer side use the top mount or side mount brackets.

Code	Mount	Finish	Ctn	List/ea
KHFB-ZC	Standard	Zinc	100 ea.	\$ 1.54
KHFB-TM	Top	Zinc	100	2.17
KHFB-SM	Side	Zinc	100	1.77

### FLAT FILE BAR

Mill finish, 1/8" thick, 1/2", 3/4" and 1" Heights available. 6' length cut to size.

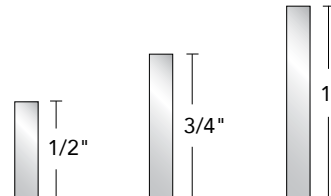

Code	Description	Ctn	List/ea
FB12-6	1/2" Ht, 6' Length	10 ea.	\$ 21.11
FB34-6	3/4" Ht, 6' Length	10	21.71
FB1-6	1" Ht, 6' Length	10	25.86

## FILE FRAME SYSTEMS

### FILE FRAME SYSTEM

From CompX Timberline

Cut-to-size kits for drawers with inside depth of less than 23". Kit includes all components needed to offer front-to-back and side-to-side filing. Two kits can be combined to accommodate lateral filing drawers. Files slide smoothly on the black rails. Easily installs using only screws. Rails snap in and out of position without tools.

Kit includes: 2 attachment rails, 2 cut-to-length 26" side rails, 1 cross rail and 2 cross rail clips.

FF-SK2 Letter Size  
 FF-SK3 Legal Size

- 1) 2 ea. Attachment rails (width of drawer)
- 2) 2 ea. Cut-to-length rails 26" (depth of drawer)
- 3) 1 ea. Cross rail
- 4) 2 ea. Cross rail clips

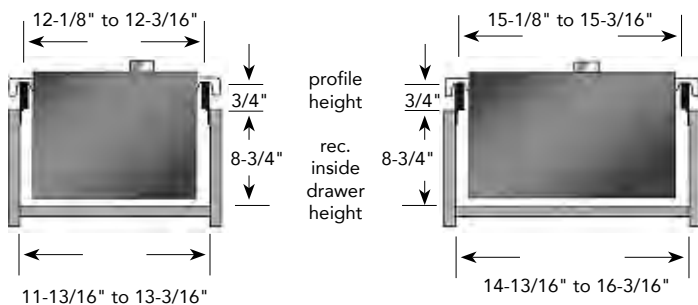
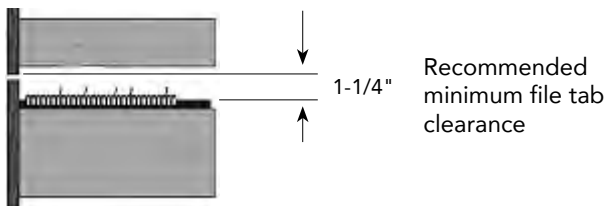
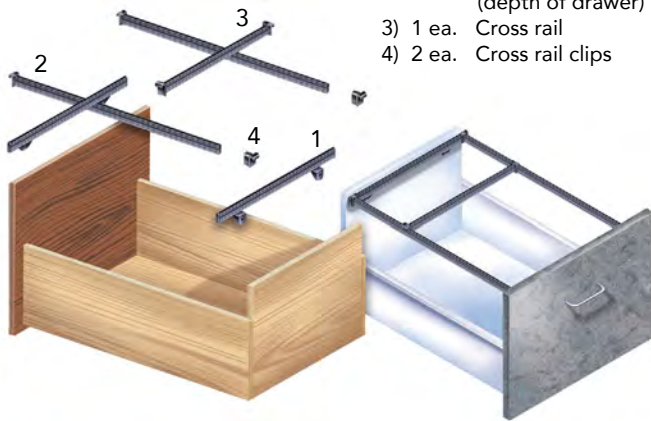

FF-SK2 Letter Size

FF-SK3 Legal Size

Code	Size	Ctn	List/kit
FF-SK2	Letter, 12.153" rails	10 ea.	\$ 19.89
FF-SK3	Legal, 15.153" rails	10	20.48

## DRAWER DIVIDERS

### DRAWER DIVIDER CLIP

Press Fits Into 1/8" Saw Slot & Holds 1/4" Thick Material. Simply slide the clip to the desired divider location. No tools needed to install.



Code	Color	Ctn	List/ea
4206BK	Black	500 ea.	\$ .89

### DIVIDER CLIP - 5mm PEG

With 5mm peg. Will accept 1/4" thick board. For vertical use only. Made of clear plastic.



4205CL-62

Code	Color	Ctn	List/C
4205CL-62	Clear	100 ea.	\$ 35.47

### FILE BAR HOLDER

Fits standard size file bars. Slides over an existing file bar, allowing you to make files legal, letter or any size you want.

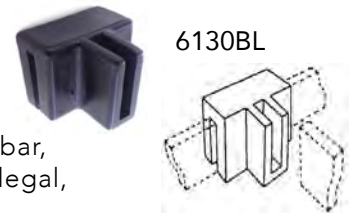

6130BL

Code	Color	Ctn	List/M
6130BL	Black	1000 ea.	\$ 306.92

### KV LETTER SIZE FILE FOLLOWER

- 476F Follower
- 476T Track



Letter-Size File Follower. When mounted, plate is 7-5/8" from track surface x 10-3/4" wide. Track is 26" long, may be recessed in 2-1/4" x 1/4" slot when 476 follower is used. Anochrome finish.

Note: Order follower and track separately.

Code	Size	Ctn	List/ea
476F	File Follower	10 ea.	\$ 39.13
476T	26" Anochrome Track	10	15.31



## RAIL SOCKETS

### BAINBRIDGE DRAWER GUIDE BACKPLATES

Highly lubricated polyethylene

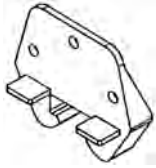

502

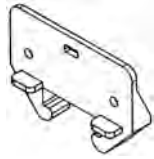

509

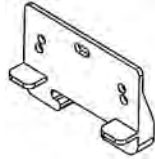

520

Bainbridge #502: Designed to fit with either screws or staples & slide on a 3/4" wide wood rail 7/32" thick. 100/box.

Bainbridge #509: Designed for larger wooden rails 13/32" x 1/4". Can be used with screws or staples. 100/box.

Bainbridge #520: 1-1/4" center to center. Designed for center mount steel rails. 100/box.

Code	Color	Ctn	List/ea
502BA	White	100 ea.	\$.68
509	White	100	.85
520	White	100	.54

### SLIDE OUT TRAY BUMPER

Screw to corner of tray to prevent scratching of cabinet door. White color.

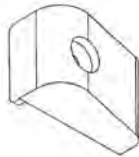

4601WH-62

Code	Color	Ctn	List/C
4601WH-62	White	5000 ea.	\$ 25.60

### PLASTIC RAIL SOCKET

Designed to be used with screw or staples on the back of the cabinet drawer area and will accept most center mount steel rails.

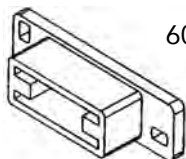

605

Overall: 2-3/8" W x 3/4" H  
Inside: 1-7/16" W x 9/16" H

Code	Color	Ctn	List/C
605	White	100 ea.	\$ 148.00

## BRACES/BRACKETS

### PLASTIC CORNER BRACE

Tenn-Tex Plastics

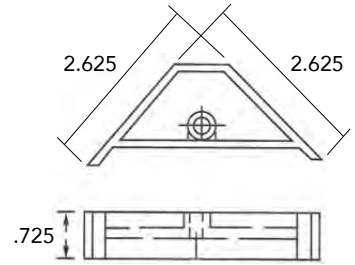

Code	Color	Ctn	List/M
T362	Natural	1400 ea.	\$ 178.64

### T-350 UNDERMOUNT INSET DRAWER BRACKET

Tenn-Tex Plastics



Features:

- Self-locating for easy mounting
- Min. 1/2" smooth horizontal adjustment
- Requires only 1/2" frame offset
- Die cast metal tapped insert with anti-slip surface
- Fine thread washer head combo drive type 17 wood screws
- Strong ABS polymer

10 sets/Ctn.

Code	Description	Ctn	List/st
B393	Polybagged Set Contains: 1 ea. T-350-00, T350-01 2 ea. HAR-077, HAR-080 4 ea. HAR-079, Instructions	10 sts.	\$ 11.83



## QUADRO MOUNTING HOLE SETBACKS & CROSS SECTIONS

For Quadro IW20 Soft Close Slides

A= 1-31/32" on 1/2" material (49.7mm)

A= 2-3/32" on 5/8" material (52.7mm)

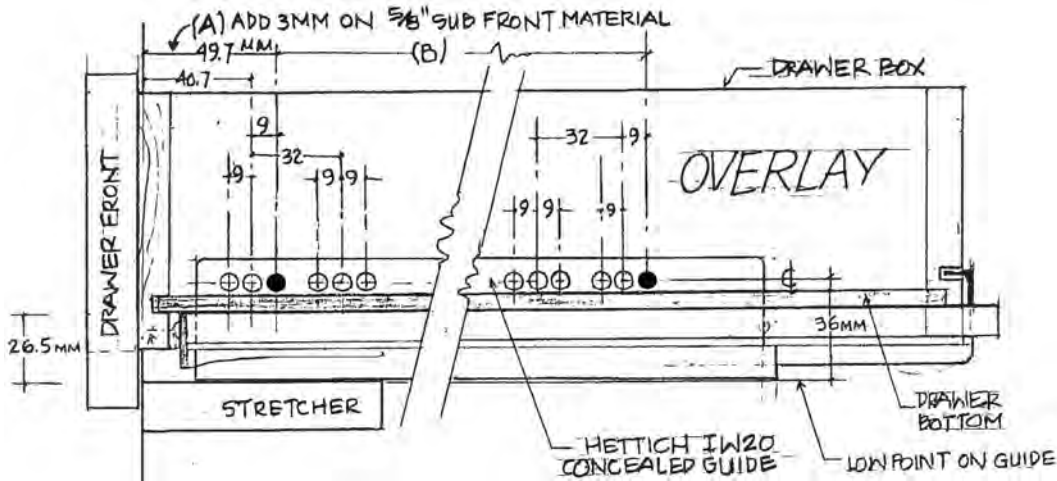

A= 2-15/32" on 1/2" material

A= 2-23/32" on 5/8" material

Slide Length mm	Hole distance	
	B mm	inches
280	160	6.30"
300	192	7.56"
320	192	7.56"
350	192	7.56"
380	224	8.82"
400	224	8.82"
420	224	8.82"
450	256	10.08"
480	256	10.08"
500	288	11.34"
520	288	11.34"
550	288	11.34"
580	352	13.86"
600	352	13.86"

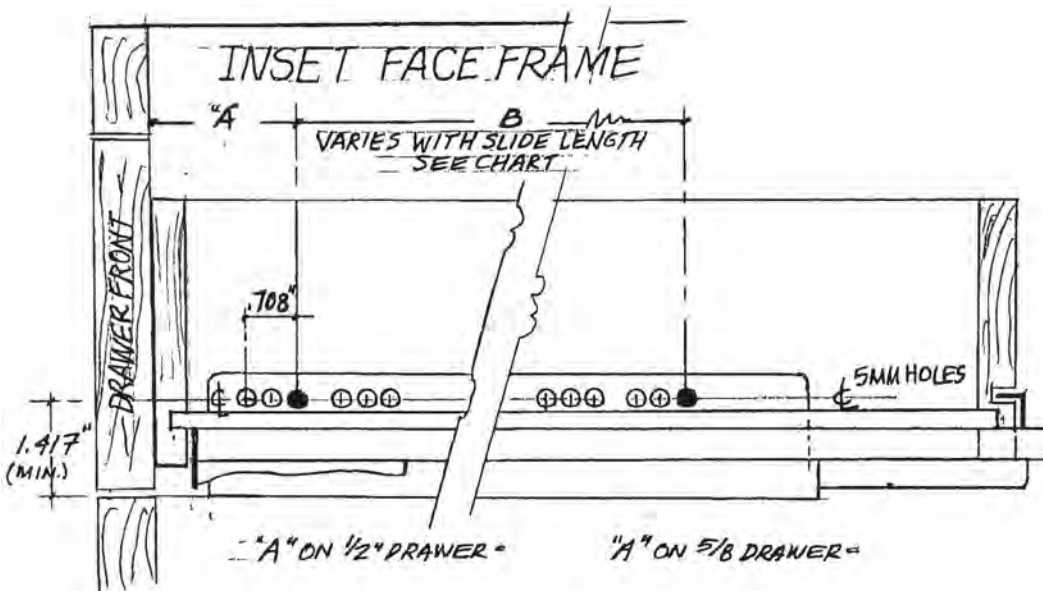





### SIDE MOUNT DRAWER SLIDE SPECIFICATIONS

**Fulterer 5000**

**Load Cap: 100 lbs.**

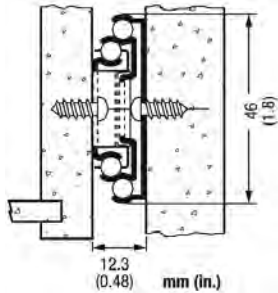

- Material: Cold Rolled Steel
- Steel ball bearings
- Easy to operate disconnect finger release trigger
- System 32 compatible hole locations
- Non handed, Hold close detent

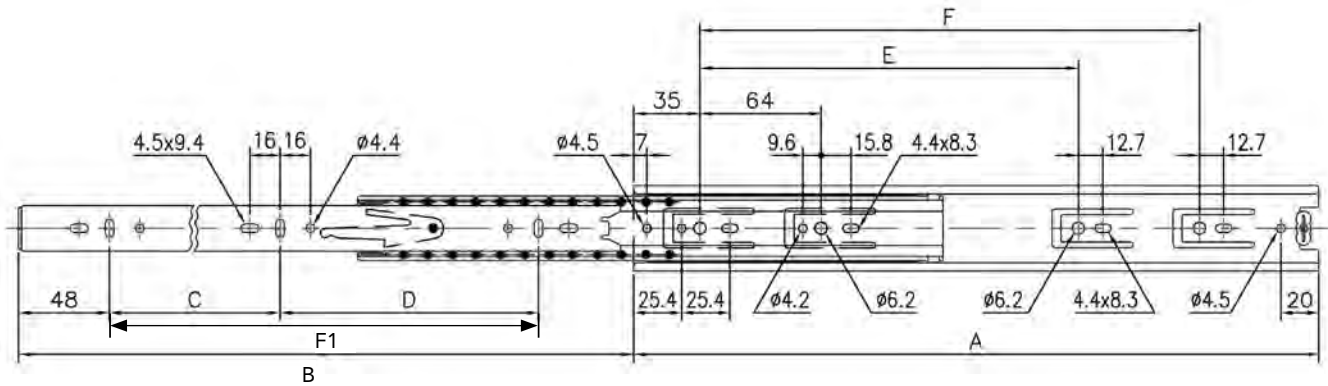

Code	Slide Length (A)		Slide Travel B (mm)	C (mm)	D (mm)	E (mm)	F (mm)	F1 (mm)
	inches	mm						
5000-6	5.91	150	150	-	-	-	-	-
5000-8	7.87	200	200	-	-	96	-	-
5000-10	9.84	250	250	-	-	160	-	160
5000-12	11.81	300	308	-	-	192	-	192
5000-14	13.78	350	350	96	160	224	-	256
5000-16	15.75	400	400	128	160	224	320	288
5000-18	17.72	450	450	160	192	224	352	352
5000-20	19.69	500	500	192	224	224	416	416
5000-22	21.65	550	550	224	256	224	448	448
5000-24	23.62	600	600	224	288	224	480	512
5000-26	25.59	650	650	256	288	224	544	544
5000-28	27.56	700	700	256	352	224	576	608
5000-30*	29.53	750	750	256		224	640	640

\*non stock



**Fulterer 5000T**

**1" Overtravel**

**Load Cap: 100 lbs.**

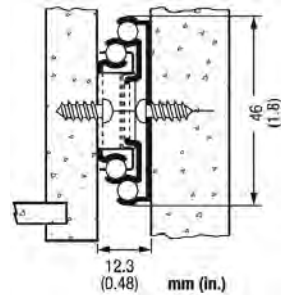

- With 25mm (.98 inch) Over-Travel
- Material: Cold Rolled Steel
- Steel ball bearings
- Easy to operate disconnect finger release trigger
- System 32 compatible hole locations
- Non handed, Hold close detent

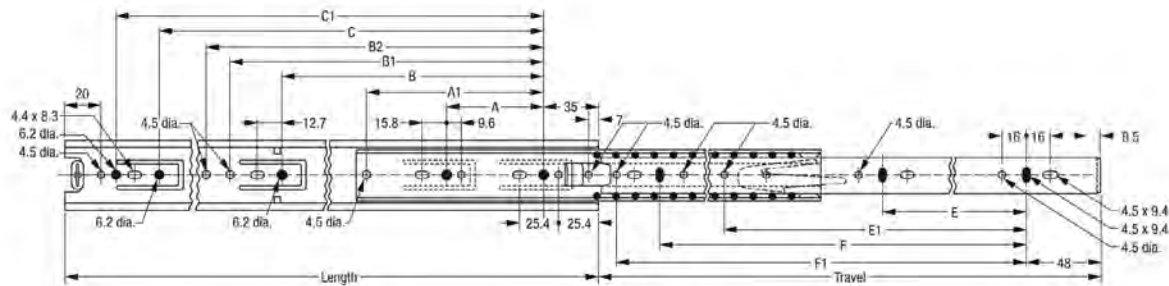

Length mm in	Travel mm in	Cabinet Profile:									Drawer Profile:				Weight kg. lbs.	Order No. zinc	Order No. black									
		A	A1	B	B1	B2	C	C1	E	E1	F	F1														
250	9.84	275	10.83	64	2.52	160	6.30							160	6.30	*	*	*								
300	11.81	325	12.80	64	2.52	128	5.04	192	7.50	224	8.82			192	7.50	224	8.82	*	400016	*						
350	13.78	375	14.76	64	2.52	128	5.04	224	8.82	282	11.10			96	3.78	256	10.08	*	600067	600068						
400	15.75	425	16.73	64	2.52	128	5.04	224	8.82	282	11.10			128	5.04	288	11.34	320	12.60	*	600074	600072				
450	17.72	475	18.70	64	2.52	128	5.04	224	8.82	282	11.10			160	6.30	271	10.67	352	13.86	*	600075	600073				
500	19.69	525	20.67	64	2.52	128	5.04	224	8.82	282	11.10			224	8.82	297	11.69	416	16.38	*	600076	600069				
550	21.65	575	22.64	64	2.52	128	5.04	224	8.82	282	11.10	352	13.86	448	17.64	480	18.90	224	8.82	323	12.72	448	17.64	*	600077	*
600	23.62	625	24.61	64	2.52			224	8.82	282	11.10	352	13.86	480	18.90			224	8.82	512	20.16	*	6000702	*		
650	25.59	675	26.58	64	2.52			224	8.82	282	11.10	352	13.86	544	21.42			256	10.08	544	21.42	*	*	*		
700	27.56	725	28.54	64	2.52			224	8.82	282	11.10	352	13.86	576	22.68			256	10.08	608	23.94	*	*	*		
750	29.53	775	30.51	64	2.52			224	8.82	282	11.10	352	13.86	640	25.20			256	10.08	640	25.20	*	*	*		



**Fulterer 5001ECD**

**Soft Close**

**Load Cap: 100 lbs.**

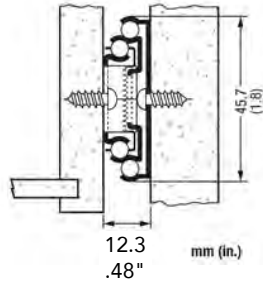

- Soft-Close, Side Mount, Full-extension
- 1/2" Side Clearance
- ECD Easy Close Device mechanism provides self-closing and impact absorbing soft-close feature
- Material: Cold Rolled Steel
- Steel ball bearings
- Easy to operate disconnect finger release trigger
- System 32 compatible hole locations
- Non handed, Hold close detent

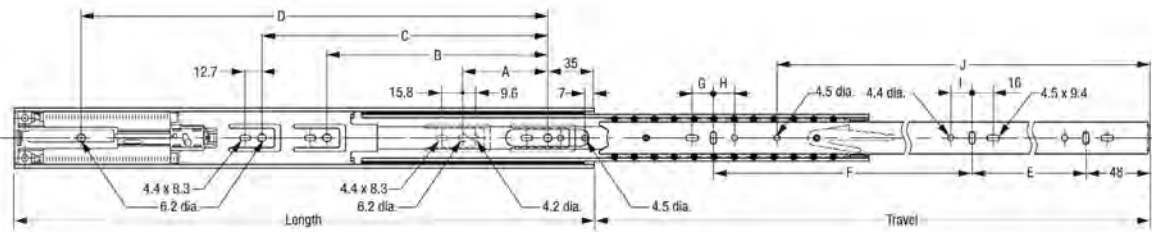

Length	Travel	Cabinet Profile:				Drawer Profile:						Weight	Order No. zinc										
		A	B	C	D	E	F	G	H	I	J												
mm	in	mm	in	mm	in	mm	in	mm	in	mm	in	mm	in	kg	lbs.								
300	11.81	245	9.65	64	2.52							18	0.63	189	7.44	*	400920						
355	13.98	350	13.78	64	2.52	128	5.04					128	5.04			*	400921						
405	15.95	400	15.75	64	2.52	180	6.30					160	6.30			*	400922						
450	17.72	450	17.72	64	2.52	224	8.82					160	6.30			*	400923						
500	19.69	500	19.69	64	2.52	256	10.08					192	7.56	128	5.04	16	0.63	16	0.63	16	0.63	*	400924
550	21.65	550	21.65	64	2.52	224	8.82	320	12.60	448	17.64	224	8.82	160	6.30		16	0.63	16	0.63	*	400925	
600	23.62	600	23.62	64	2.52	224	8.82	352	13.86	512	20.16	256	10.08	160	6.30	16	0.63	16	0.63	16	0.63	*	400926
650	25.59	650	25.69	64	2.52	224	8.82	416	16.19	576	22.66	256	10.08	192	7.66	16	0.63	16	0.63	16	0.63	*	400927
700	27.56	700	27.56	64	2.52	224	8.82	448	17.69	608	23.94	288	11.34	224	8.82	16	0.63	16	0.63	16	0.63	*	400928

15



**Fulterer 5045**

**Load Cap: 100 lbs.**

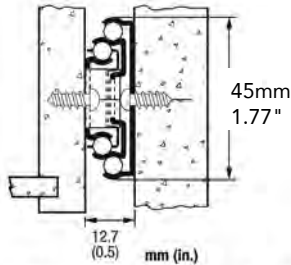

12.7 mm (0.50 in.) is the actual size of the slide.  
Allow a min. of 13 mm (0.51 in.) for clearance  
and a maximum of 13.5 mm (0.53 in.)

- Side Mount, Full-extension
- 1/2" Side Clearance
- Material: Cold Rolled Steel
- Steel ball bearings
- Easy to operate disconnect finger release trigger
- System 32 compatible hole locations
- Non handed, Hold close detent

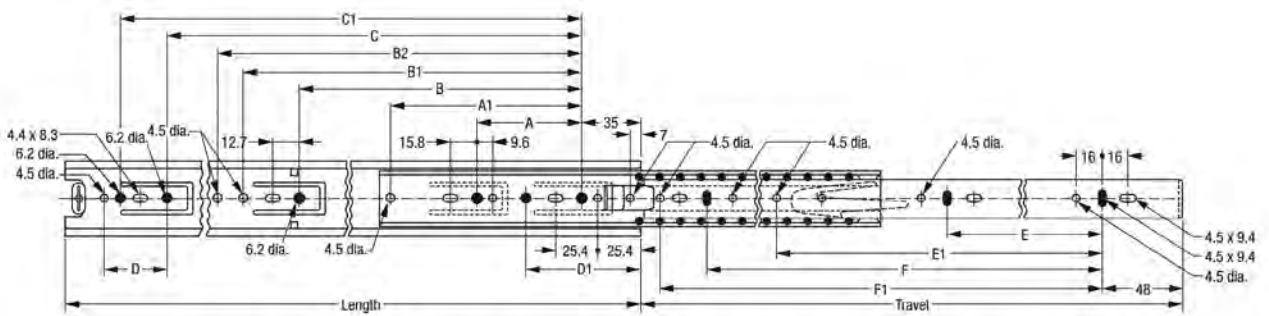

Length	Travel	Cabinet Profile:										Drawer Profile:							
		A	A1	B	B1	B2	C	C1	D	D1	E	E1	F	F1					
mm	in	mm	in	mm	in	mm	in	mm	in	mm	in	mm	in	mm	in				
250	9.84	250	9.84	64	2.52	160	6.30	195	7.68					160	6.30				
300	11.81	308	11.81	64	2.52	128	5.04	192	7.56	224	8.82	224	8.82	192	7.56	224	8.82		
350	13.78	350	13.78	64	2.52	128	5.04	224	8.82	282	11.10	296	11.65	96	3.78	256	10.08		
400	15.75	400	15.75	64	2.52	128	5.04	224	8.82	282	11.10	320	12.60	128	5.04	288	11.34	320	12.60
450	17.72	450	17.72	64	2.52	128	5.04	224	8.82	282	11.10	352	13.86	160	6.30	271	10.67	352	13.86
500	19.69	500	19.69	64	2.52	128	5.04	224	8.82	282	11.10	416	16.38	192	7.56	297	11.69	416	16.38
550	21.65	550	21.65	64	2.52	128	5.04	224	8.82	282	11.10	352	13.86	224	8.82	323	12.72	448	17.64
600	23.62	600	23.62	64	2.52	224	8.82	282	11.10	352	13.86	480	18.90	224	8.82			512	20.16
650	25.59	650	25.59	64	2.52	224	8.82	282	11.10	352	13.86	544	21.42	256	10.08			544	21.42
700	27.56	700	27.56	64	2.52	224	8.82	282	11.10	352	13.86	576	22.68	256	10.08			608	23.94

Packing Unit: 15 pair per box



**Fulterer 5210**

**Heavy Duty Slide**

**Load Cap: 200 lbs.**

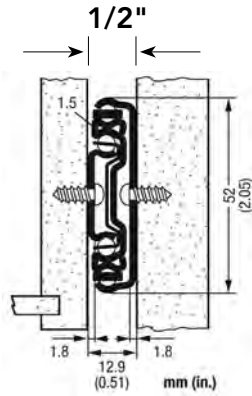

- 1/2" Side Space
- Precision steel ball-bearing drawer slide for heavy duty applications: Residential and Commercial
- Easy to operate disconnect, finger release trigger
- System 32 compatible hole locations
- Drawer slide is non-handed and has a hold-close detent
- Full extension + 1" over-extension

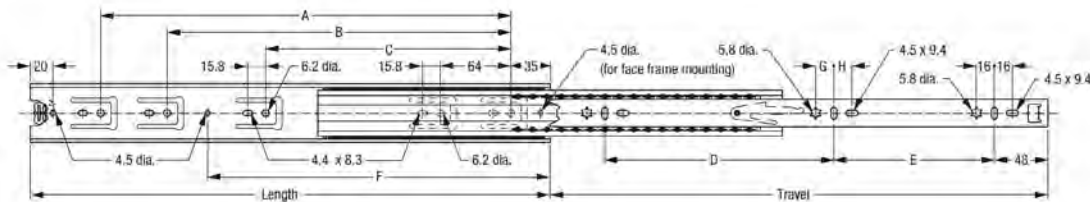

Length	Travel	Cabinet Profile:				Drawer Profile:				Weight	Order No.								
		A	B	C	F	D	E	G	H		kg	lbs	black	zinc					
mm	in	mm	in	mm	in	mm	in	mm	in	mm	in	mm	in	mm	in	mm	in		
250	9.84	275	10.83	160	6.30	160	6.30					*	*	400169					
300	11.81	325	12.80	192	7.56	192	7.56	16	0.63	16	0.63	*	*	400181	400170				
350	13.78	375	14.76	224	8.82	224	8.82	16	0.63	16	0.63	*	*	400182	400171				
400	15.75	425	16.73	320	12.60	224	8.82	323	12.72	160	6.30	128	5.04	16	0.63	16	0.63	*	
450	17.72	475	18.70	352	13.86	224	8.82	323	12.72	192	7.56	160	6.30	16	0.63	16	0.63	*	
500	19.69	525	20.67	416	16.39	224	8.82	323	12.72	224	8.82	192	7.56	16	0.63	16	0.63	*	
550	21.65	575	22.64	448	17.64	224	8.82	323	12.72	224	8.82	224	8.82	16	0.63	16	0.63	*	
600	23.62	625	24.61	480	18.90	224	8.82	323	12.72	288	11.34	224	8.82	16	0.63	16	0.63	*	
650	25.59	675	26.58	544	21.42	352	13.86	224	8.82	323	12.72	288	11.34	256	10.18	16	0.63	16	0.63
700	27.56	725	28.54	576	22.68	352	13.86	224	8.82	323	12.72	352	13.86	256	10.18	16	0.63	16	0.63



**Fulterer 5210ECD**

**Soft Close  
Heavy Duty Slide**

**Load Cap: 200 lbs.**

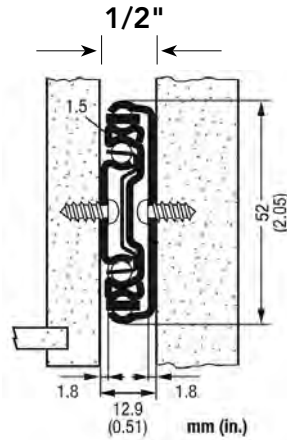

- 1/2" Side Space
- Precision steel ball-bearing drawer slide for heavy duty applications in office furniture, architectural millwork and institutional applications
- Easy to operate disconnect, finger release trigger
- System 32 compatible hole locations
- Drawer slide is non-handed and has a hold-close detent
- ECD Easy Close Device:

**Soft Close / Self Close**

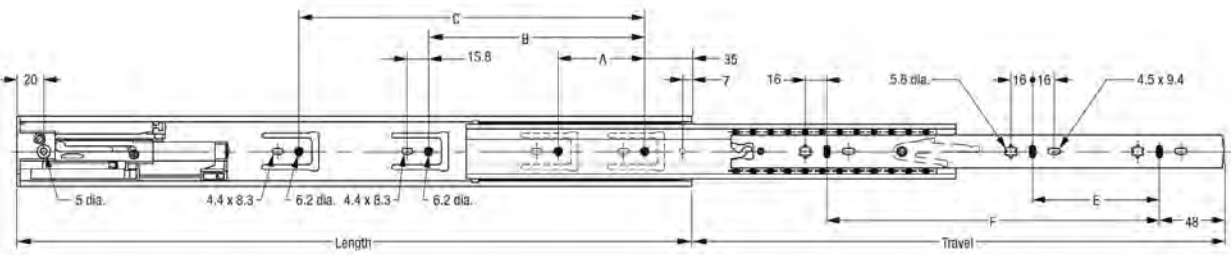

Length	Travel	Cabinet Profile:			Drawer Profile:		Weight	Order No.						
		A	B	C	E	F								
mm	in	mm	in	mm	in	mm	in	kg.	lbs.	zinc				
400	15.75	425	16.73	64	2.52	160	6.30	96	3.78	288	11.34	*	400110	
450	17.72	475	18.70	64	2.52	224	8.82	128	5.04	320	12.68	*	400111	
500	19.69	525	20.69	64	2.52	256	10.18	128	5.04	352	13.86	*	400112	
550	21.65	575	22.64	64	2.52	224	8.82	320	12.68	416	16.38	*	400113	
600	23.62	625	24.61	64	2.52	224	8.82	352	13.86	192	7.56	448	17.04	400115
650	25.59	675	26.58	64	2.52	224	8.82	416	16.38	192	7.56	512	20.16	400116
700	27.56	725	28.54	64	2.52	224	8.82	416	16.38	224	8.82	544	21.42	*



### Cabinet Member Dimensions

KV 8400

Load Cap: 100 lbs.

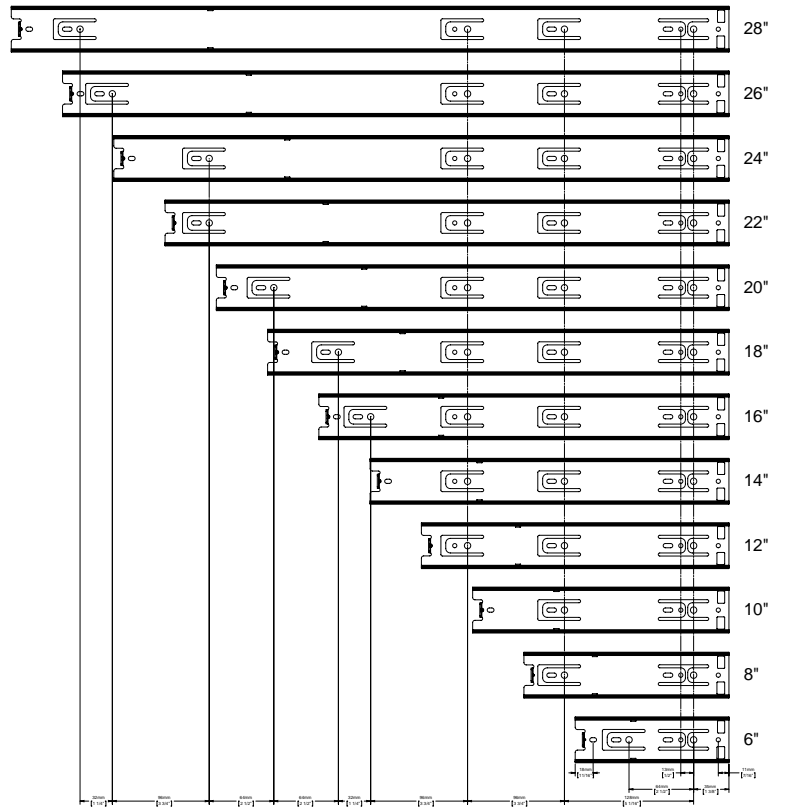
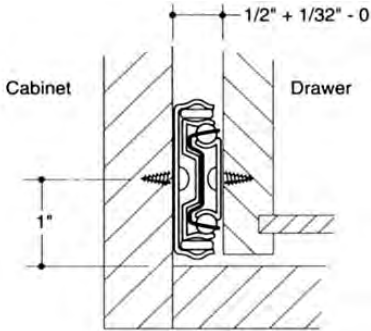

### Drawer Member Dimensions

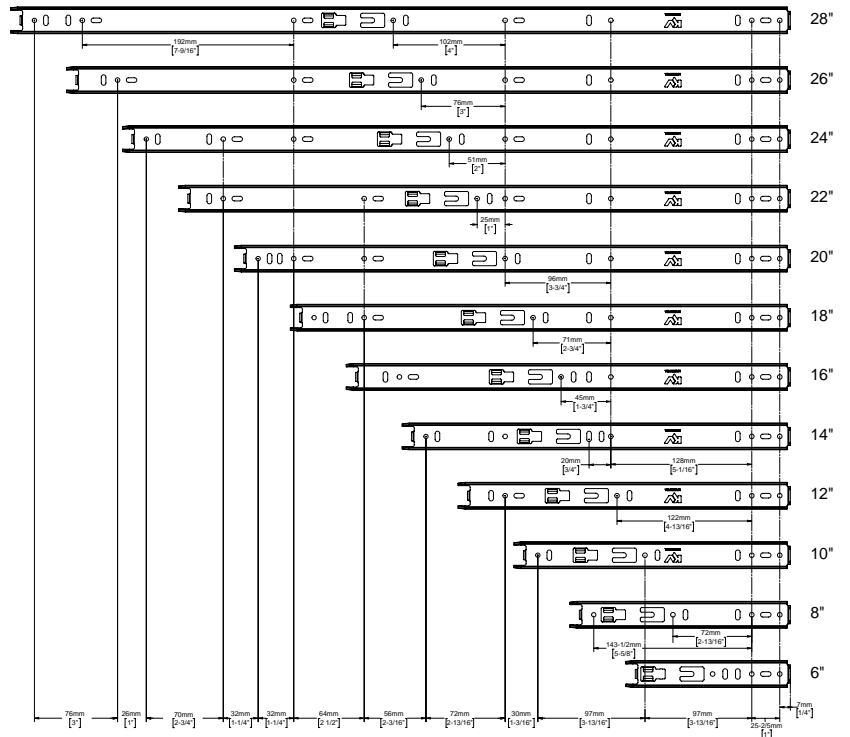



**KV 8450 Soft Close / Load Cap: 100 lbs.**

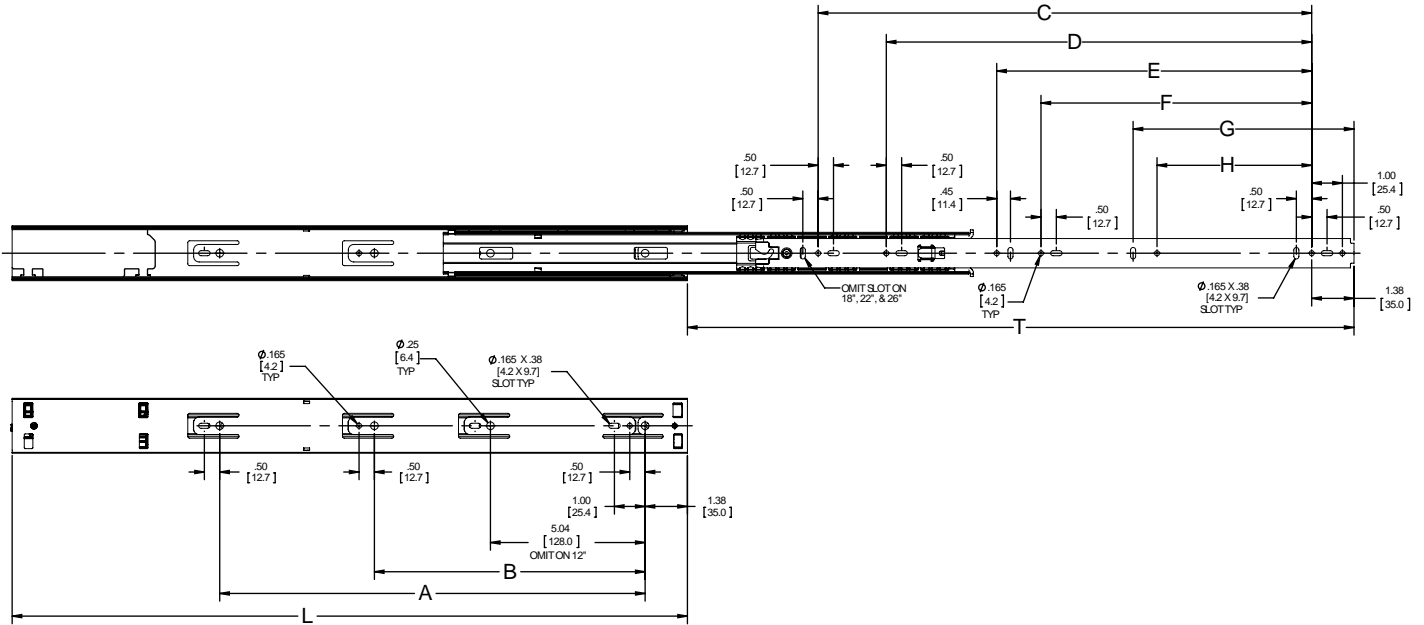

SKU Number*	Slide Size inch/mm	Length inch/mm	Travel inch/mm	A inch/mm	B inch/mm	C inch/mm	D inch/mm	E inch/mm	F inch/mm	G Inch/mm	H Inch/mm
8450FMB 12	12" [300mm]	12.00" [304.8mm]	10.19" [258.8mm]	3.78" [96.0mm]	-	-	-	3.74" [94.9mm]	-	7.08" [179.8mm]	1.26" [32.0mm]
8450FMB 14	14" [350mm]	14.00" [355.6mm]	13.99" [355.3mm]	-	-	-	-	5.54" [140.6mm]	-	7.08" [179.8mm]	1.26" [32.0mm]
8450FMB 16	16" [400mm]	16.00" [406.4mm]	15.99" [406.1mm]	-	8.82" [224.0mm]	-	-	7.54" [191.4mm]	5.04" [128.0mm]	7.08" [179.8mm]	-
8450FMB 18	18" [450mm]	18.00" [457.2mm]	17.99" [456.9mm]	-	8.82" [224.0mm]	12.60" [320.0mm]	-	8.54" [216.8mm]	-	7.08" [179.8mm]	5.04" [128.0mm]
8450FMB 20	20" [500mm]	20.00" [508.0mm]	19.99" [207.7mm]	12.60" [320.0mm]	8.82" [224.0mm]	13.86" [352.0mm]	-	9.54" [242.2mm]	-	7.08" [179.8mm]	5.04" [128.0mm]
8450FMB 22	22" [550mm]	22.00" [558.8mm]	21.99" [558.5mm]	13.86" [352.0mm]	8.82" [224.0mm]	16.38" [416.0mm]	15.12" [384.0mm]	10.54" [267.6mm]	8.82" [224.0mm]	7.08" [179.8mm]	5.04" [128.0mm]
8450FMB 24	24" [600mm]	24.00" [609.3mm]	23.99" [609.3mm]	15.12" [384.0mm]	8.82" [224.0mm]	17.64" [448.0mm]	16.38" [416.0mm]	11.54" [293.0mm]	8.82" [224.0mm]	7.08" [179.8mm]	5.04" [128.0mm]
8450FMB 26	26" [650mm]	26.00" [660.4mm]	25.99" [660.1mm]	17.64" [448.0mm]	8.82" [224.0mm]	20.16" [512.1mm]	17.64" [448.0mm]	12.54" [318.4mm]	8.82" [224.0mm]	7.08" [179.8mm]	5.04" [128.0mm]
8450FMB 28	28" [700mm]	28.00" [711.2mm]	27.99" [710.9mm]	20.16" [512.0mm]	8.82" [224.0mm]	21.42" [544.0mm]	18.90" [480.0mm]	13.54" [343.8mm]	8.82" [224.0mm]	7.08" [179.8mm]	5.04" [128.0mm]

15

<b>Product</b>	Soft Close Drawer Slide	<b>Height</b>	1.79"	<b>Hardware</b>	#7 x 1/2" Pan Head
<b>Mounting</b>	Side	<b>Finish</b>	Anochrome	<b>Sizes</b>	12", 14", 16", 18", 20", 22", 24", 26" and 28"
<b>Clearance</b>	.50"	<b>Travel</b>	Full Extension	<b>Packaging</b>	Bulk Pack (8450B) All Sizes, 10 pr/ctn.
<b>Load Rating</b>	100 lbs.	<b>Action</b>	Telescopic		





**KV Tru-Trac TT100**

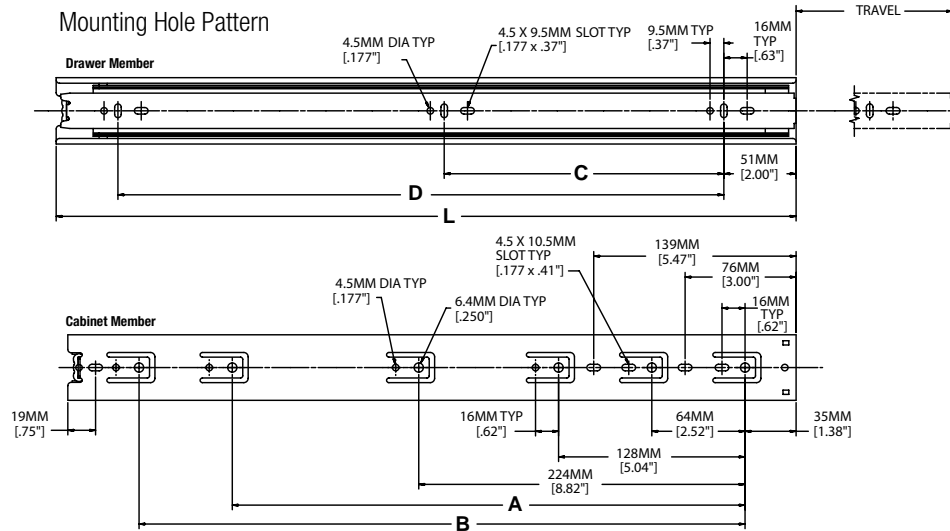

SKU Number	Slide Size mm/inch	Length mm/inch	Sets per Pallet*	Travel mm/inch	A mm/inch	B mm/inch	C mm/inch	D mm/inch
TT100B 250	250mm [10"]	250mm [9.84"]	960	250mm [9.84"]	—	—	—	—
TT100B 300	300mm [12"]	300mm [11.81"]	850	300mm [11.81"]	224mm [8.82"]	—	—	—
TT100B 350	350mm [14"]	350mm [13.78"]	700	350mm [13.78"]	—	—	128mm [5.04"]	256mm [10.08"]
TT100B 400	400mm [16"]	400mm [15.75"]	560	400mm [15.75"]	288mm [11.34"]	—	160mm [6.30"]	320mm [12.60"]
TT100B 450	450mm [18"]	450mm [17.72"]	550	450mm [17.72"]	352mm [13.86"]	—	160mm [6.30"]	352mm [13.86"]
TT100B 500	500mm [20"]	500mm [19.69"]	440	500mm [19.69"]	352mm [13.86"]	416mm [16.38"]	192mm [7.56"]	416mm [16.38"]
TT100B 550	550mm [22"]	550mm [21.65"]	400	550mm [21.65"]	352mm [13.86"]	416mm [16.38"]	224mm [8.82"]	448mm [17.64"]
TT100B 600	600mm [24"]	600mm [23.62"]	400	600mm [23.62"]	224mm [8.82"]	352mm [13.86"]	480mm [18.90"]	256mm [10.08"]
TT100B 650	650mm [26"]	650mm [25.29"]	400	650mm [25.29"]	224mm [8.82"]	352mm [13.86"]	544mm [21.42"]	288mm [11.34"]
TT100B 700	700mm [28"]	700mm [27.56"]	300	700mm [27.56"]	224mm [8.82"]	352mm [13.86"]	544mm [21.42"]	288mm [11.34"]

15



**KV DuriSlide DUR45B**

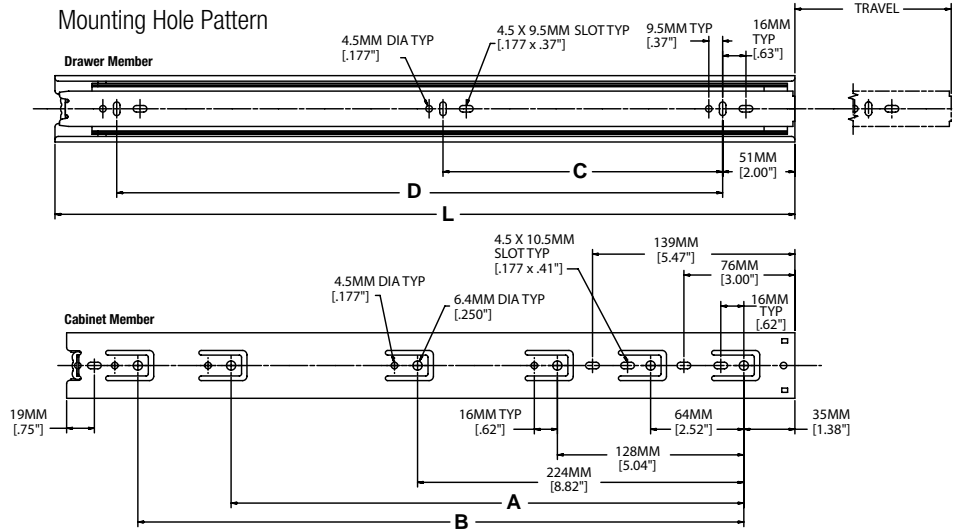

SKU Number Bulk Pack	Bulk Pack MOQ - Sets*	SKU Number Q Pack	Q Pack MOQ - Eaches*	Slide Size mm/inch	Length mm/inch	Travel mm/inch	A mm/inch	B mm/inch	C mm/inch	D mm/inch
DUR45B 250	960	DUR45-90 250	2,400	250mm	250mm	250mm	—	—	—	176mm
		DUR45-92 250	2,400	[10"]	[9.84"]	[9.84"]	—	—	—	[6.93"]
DUR45B 300	850	DUR45-90 300	1,900	300mm	300mm	300mm	—	—	96mm	224mm
		DUR45-92 300	1,900	[12"]	[11.81"]	[11.81"]	—	—	[3.76"]	[8.82"]
DUR45B 350	700	DUR45-90 350	1,900	350mm	350mm	350mm	—	—	128mm	256mm
		DUR45-92 350	1,900	[14"]	[13.78"]	[13.78"]	—	—	[5.04"]	[10.08"]
DUR45B 400	560	DUR45-90 400	1,600	400mm	400mm	400mm	288mm	—	160mm	320mm
		DUR45-92 400	1,600	[16"]	[15.75"]	[15.75"]	[11.34"]	—	[6.30"]	[12.60"]
DUR45B 450	550	DUR45-90 450	1,200	450mm	450mm	450mm	352mm	—	160mm	352mm
		DUR45-92 450	1,200	[18"]	[17.72"]	[17.72"]	[13.86"]	—	[6.30"]	[13.86"]
DUR45B 500	440	DUR45-90 500	1,200	500mm	500mm	500mm	352mm	416mm	192mm	416mm
		DUR45-92 500	1,200	[20"]	[19.69"]	[19.69"]	[13.86"]	[16.38"]	[7.56"]	[16.38"]
DUR45B 550	400	DUR45-90 550	1,000	550mm	550mm	550mm	352mm	416mm	224mm	448mm
		DUR45-92 550	1,000	[22"]	[21.65"]	[21.65"]	[13.86"]	[16.38"]	[8.82"]	[17.64"]
DUR45B 600	400	DUR45-90 600	1,000	600mm	600mm	600mm	224mm	352mm	480mm	256mm
		DUR45-92 600	1,000	[24"]	[23.62"]	[23.62"]	[8.82"]	[13.86"]	[18.90"]	[10.08"]
DUR45B 650	400	DUR45-90 650	1,000	650mm	650mm	650mm	224mm	352mm	544mm	288mm
		DUR45-92 650	1,000	[26"]	[25.29"]	[25.29"]	[8.82"]	[13.86"]	[21.42"]	[11.34"]
DUR45B 700	300	DUR45-90 700	600	700mm	700mm	700mm	224mm	352mm	544mm	288mm
		DUR45-92 700	600	[28"]	[27.56"]	[27.56"]	[8.82"]	[13.86"]	[21.42"]	[11.34"]



**KV6505**

**1" Overtravel**

**Load Cap: 125 lbs.**

**Rail Mounted  
Easy Disconnect**

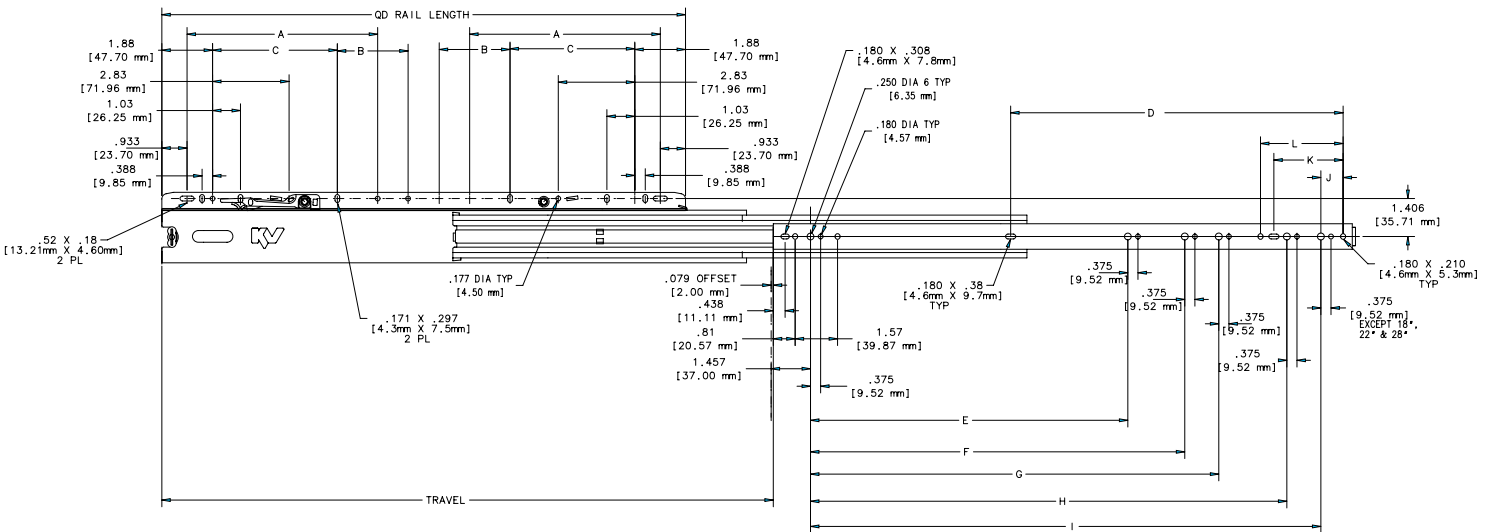
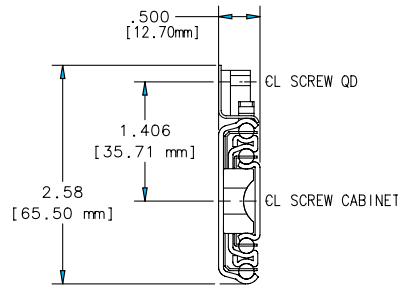

SLIDE LENGTH	TRAVEL	QD RAIL LENGTH	A	B	C	D	E	F	G	H	I	J	K	L
12"	12.80 [325mm]	10.57 [268.5mm]	-	-	-	7.06 [179.32mm]	8.82 [224mm]	-	-	-	8.82 [224mm]	.903 [22.94mm]	-	-
14"	14.76 [375mm]	10.57 [268.5mm]	-	-	-	9.18 [233.17mm]	8.82 [224mm]	-	-	-	8.82 [224mm]	2.903 [73.74mm]	1.06 [26.92mm]	-
16"	16.73 [425mm]	14.98 [380.5mm]	-	-	2.83 [71.96mm]	10.06 [255.52mm]	9.30 [236.22mm]	-	-	-	12.60 [320mm]	1.124 [28.55mm]	-	3.06 [77.70mm]
18"	18.70 [475mm]	14.98 [380.5mm]	-	-	2.83 [71.96mm]	10.06 [255.52mm]	9.30 [236.22mm]	-	-	-	13.86 [352mm]	1.864 [46.58mm]	1.06 [26.92mm]	3.06 [77.70mm]
20"	20.67 [525mm]	14.98 [380.5mm]	-	-	2.83 [71.96mm]	11.18 [283.97mm]	9.30 [236.22mm]	-	-	-	12.60 [320mm]	1.344 [34.14mm]	-	3.06 [77.70mm]
22"	22.64 [575mm]	19.39 [492.5mm]	-	2.62 [66.55mm]	2.83 [71.96mm]	12.31 [312.67mm]	12.31 [312.67mm]	13.86 [352mm]	15.12 [384mm]	17.64 [448mm]	18.90 [480mm]	.824 [20.93mm]	-	3.06 [77.70mm]
24"	24.61 [625mm]	19.39 [492.5mm]	-	2.62 [66.55mm]	2.83 [71.96mm]	13.06 [331.72mm]	13.06 [331.72mm]	-	-	15.12 [384mm]	18.90 [480mm]	2.825 [71.76mm]	1.06 [26.92mm]	-
26"	26.57 [675mm]	23.80 [604.5mm]	7.06 [179.24mm]	3.25 [82.55mm]	2.83 [71.96mm]	14.18 [360.17mm]	14.18 [360.17mm]	-	-	15.12 [384mm]	21.42 [544mm]	2.305 [58.55mm]	1.06 [26.92mm]	3.06 [77.70mm]
28"	28.54 [725mm]	23.80 [604.5mm]	7.06 [179.24mm]	3.25 [82.55mm]	2.83 [71.96mm]	15.31 [388.87mm]	15.31 [388.87mm]	-	16.38 [416mm]	18.90 [480mm]	23.94 [608mm]	1.785 [45.34mm]	1.06 [26.92mm]	3.06 [77.70mm]

<b>Product</b>	Low Profile Drawer Slide	<b>Height</b>	2.58" (Includes QD Rail)	<b>Hardware</b>	#8 x 7/16" Wood Screw
<b>Mounting</b>	Side	<b>Finish</b>	Zinc Plated	<b>Sizes</b>	12", 14", 16", 18", 20", 22", 24", 26" and 28"
<b>Clearance</b>	.50"	<b>Travel</b>	Over Travel	<b>Packaging</b>	Bulk Pack (6505B) All Sizes, 5 pr/ctn.
<b>Load Rating</b>	125 lbs.	<b>Action</b>	Telescopic		



**KV 8500  
and  
KV 8505**

**File Drawer Slide**

**Load Cap: 150 lbs.**

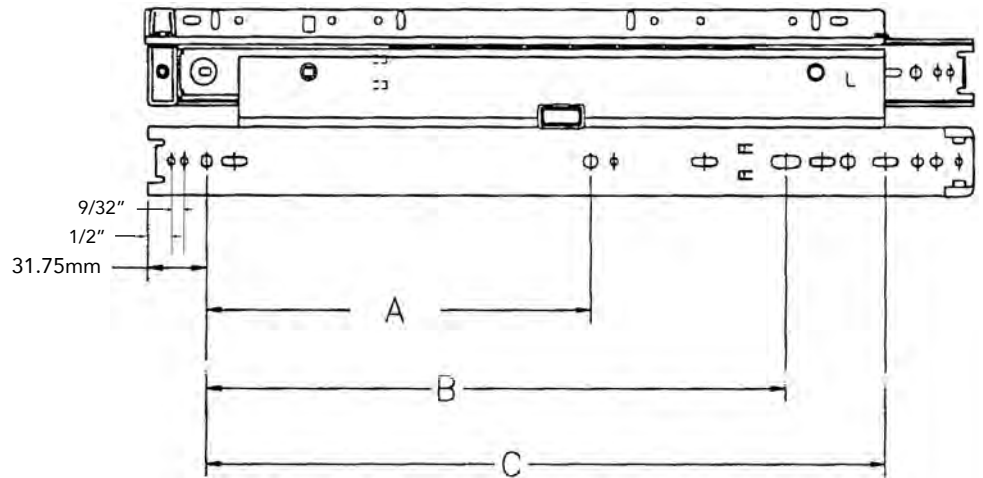

**KV 8500 and  
KV 8505  
Cabinet Member  
Hole Pattern**

Slide Length	#8500 Travel	#8505 Travel	Rail Length	A	B	C
12"	11 23/32"	13 7/32"	10"	---	160mm	---
13"	12 23/32"	14 7/32"	11"	---	192mm	224mm
14"	13 23/32"	15 7/32"	12"	---	224mm	---
15"	14 23/32"	16 7/32"	13"	---	256mm	---
16"	15 23/32"	17 7/32"	14"	---	288mm	---
17"	16 23/32"	18 7/32"	15"	---	288mm	---
18"	17 23/32"	19 7/32"	16"	224mm	320mm	352mm
19"	18 23/32"	20 7/32"	17"	---	352mm	---
20"	19 23/32"	21 7/32"	18"	224mm	384mm	---
21"	20 23/32"	22 7/32"	19"	---	416mm	---
22"	21 23/32"	23 7/32"	20"	224mm	416mm	---
23"	22 23/32"	24 7/32"	21"	---	448mm	480mm
24"	23 23/32"	25 7/32"	22"	---	480mm	---
25"	24 23/32"	26 7/32"	23"	---	512mm	---
26"	25 23/32"	27 7/32"	24"	---	544mm	---
27"	26 23/32"	28 7/32"	25"	---	544mm	---
28"	27 23/32"	29 7/32"	26"	---	576mm	608mm
29"	28 23/32"	30 7/32"	27"	---	608mm	---
30"	29 23/32"	31 7/32"	28"	---	640mm	---

**KV 8500/8505  
Drawer Member Hole Pattern**

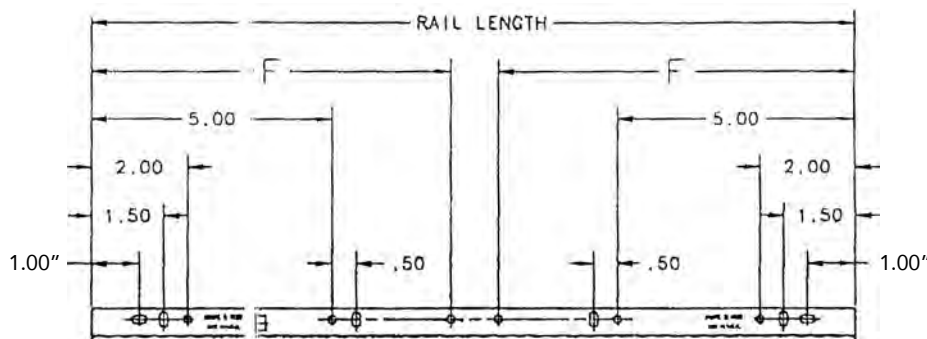

Rail Length	F
10"	---
11"	---
12"	---
13"	---
14"	---
15"	---
16"	---
17"	8"
18"	8"
19"	8"
20"	8"
21"	8"
22"	8"
23"	8"
24"	8"
25"	8"
26"	8"
27"	8"
28"	8"



**KV8810 Heavy Duty Slide Load Cap: 200 lbs.**

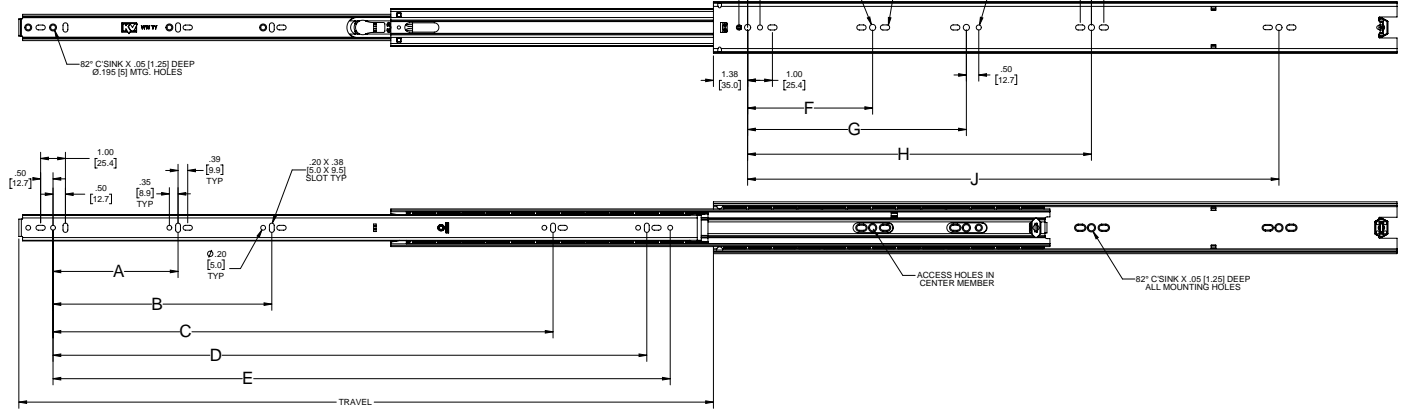
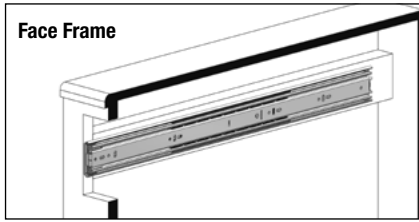

SKU Number	Slide Size inch/mm	Length inch/mm	Travel inch/mm	A inch/mm	B inch/mm	C inch/mm	D inch/mm	E inch/mm	F inch/mm	G Inch/mm	H Inch/mm	J Inch/mm
8810B 10	10" [250mm]	9.84" [250mm]	10" [254mm]	-	-	-	-	7.16" [182mm]	5.04" [128mm]	-	-	-
8810B 12	12" [300mm]	11.81" [300mm]	12" [305mm]	-	-	-	-	9.13" [232mm]	5.04" [128mm]	8.82" [224mm]	-	-
8810B 14	14" [350mm]	13.78" [350mm]	14" [356mm]	-	-	-	10.08" [256mm]	-	6.30" [160mm]	8.82" [224mm]	-	-
8810B 16	16" [400mm]	15.75" [400mm]	16" [406mm]	-	-	-	11.34" [288mm]	-	-	8.82" [224mm]	12.60" [320mm]	-
8810B 18	18" [450mm]	17.72" [450mm]	18" [457mm]	5.04" [128mm]	-	-	12.60" [320mm]	-	5.04" [128mm]	8.82" [224mm]	13.86" [352mm]	-
8810B 20	20" [500mm]	19.69" [500mm]	20" [508mm]	5.04" [128mm]	-	-	15.12" [384mm]	-	5.04" [128mm]	8.82" [224mm]	-	16.38" [416mm]
8810B 22	22" [550mm]	21.65" [550mm]	22" [559mm]	5.04" [128mm]	-	-	16.38" [416mm]	-	5.04" [128mm]	11.43" [256mm]	13.86" [352mm]	17.64" [448mm]
8810B 24	24" [600mm]	23.62" [600mm]	24" [610mm]	5.04" [128mm]	8.82" [224mm]	16.38" [416mm]	20.16" [512mm]	-	5.04" [128mm]	-	13.86" [352mm]	18.90" [480mm]
8810B 26	26" [650mm]	25.59" [650mm]	26" [660mm]	5.04" [128mm]	8.82" [224mm]	-	20.16" [512mm]	-	5.04" [128mm]	8.82" [224mm]	13.86" [352mm]	21.42" [544mm]
8810B 28	28" [700mm]	27.56" [700mm]	28" [711mm]	5.04" [128mm]	8.82" [224mm]	20.16" [512mm]	23.94" [608mm]	-	5.04" [128mm]	8.82" [224mm]	13.86" [352mm]	21.42" [544mm]

15

**Butterfly Lever Release**

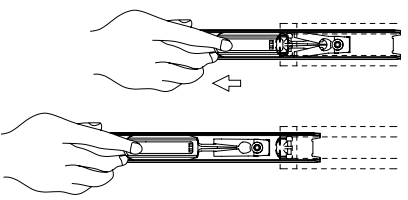

<b>Mounting</b>	Side	<b>Max Drawer Width:</b>	42"
<b>Clearance</b>	.75" (+.03" - 0")	<b>Hardware</b>	#8 or #10 x 5/8" Phillips Flathead
<b>Load Rating</b>	200 lbs.	<b>Stocking Sizes</b>	12", 14", 16", 18", 20", 22", 24", 26" and 28"
<b>Height</b>	2.09" (53mm)	<b>Packaging</b>	Bulk Pack (8810B) All Sizes, 4 pr/ctn.
<b>Finish</b>	Zinc Plated		
<b>Travel</b>	Full Extension		



**GS4270 G-SLIDE SPECIFICATIONS - SOFT CLOSE**

**GS4270**

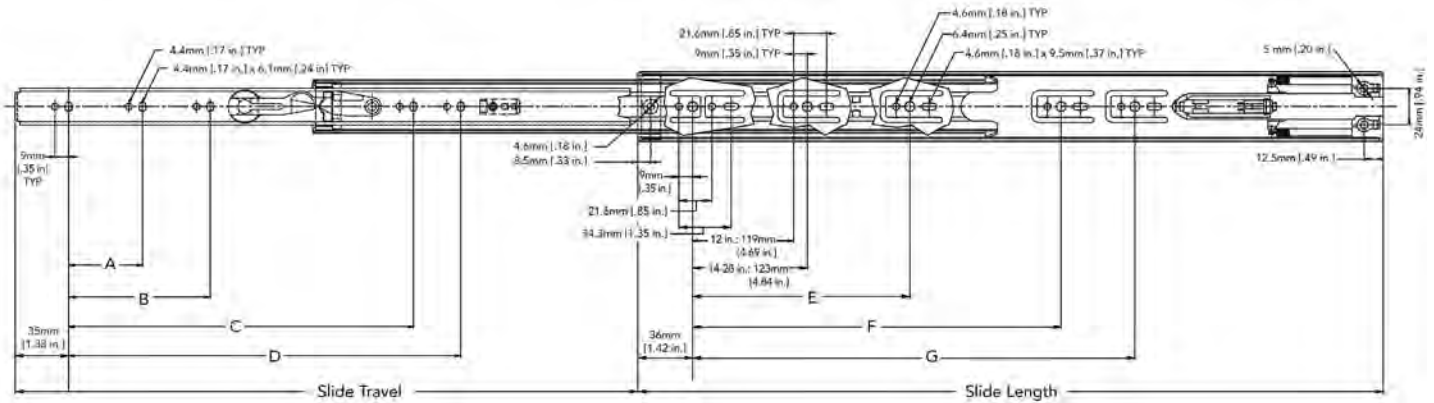

Size	Slide Length	Travel	A	B	C	D	E	F	G
12"	300	213				156			
14"	350	303				200			
16"	400	404	96			256	208		
18"	450	455	128			294	256		
20"	500	505	96	160		344	304		
22"	550	555	96	160		394	224	352	
24"	600	605	128	192		444	224	352	
26"	650	655	128	224	416	494	224	352	448
28"	700	705	128	224	480	544	224	352	496

**GS4260 G-SLIDE SPECIFICATIONS - PUSH OPEN**

**GS4260**

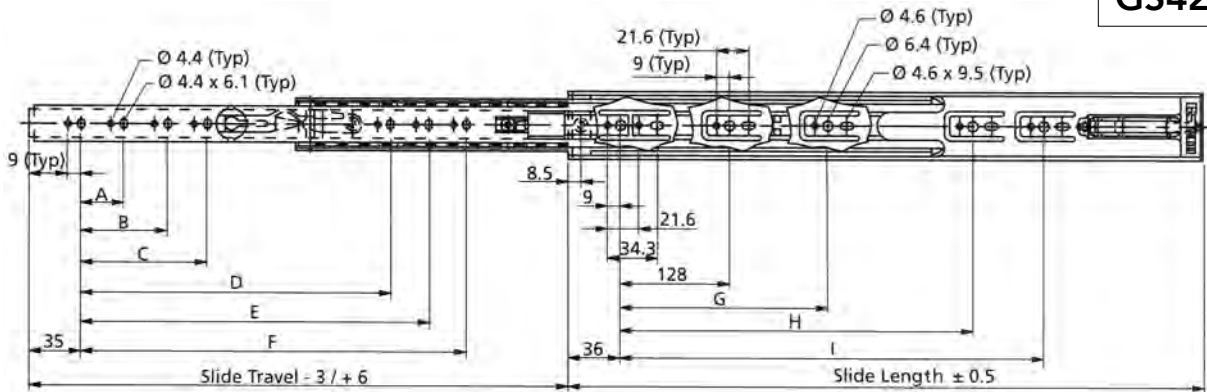

Travel	A	B	C	D	E	F	G	H	I	Width (mm)
306						200				400
356	96					256	192			450
406	128					294	224			500
457	96	160				344	288			550
508	96	160	352			394	224	352		600
559	128	192	384			444	224	352		650
610	128	224	416			494	224	352	448	700
660	128	224	416	480		544	224	352	480	750
711	128	224	288	480	544	594	224	352	544	800



KV8000

Load Cap: 130 lbs.

Pull Out Pantry Slide

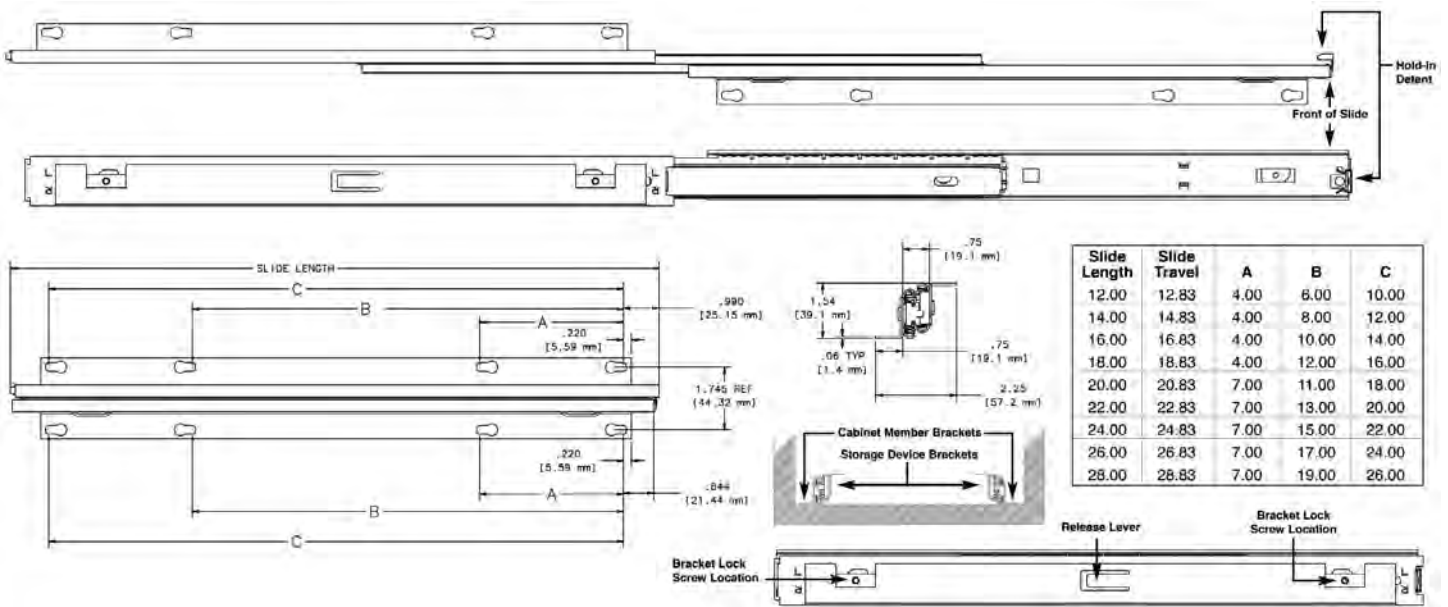

INSTALLATION INSTRUCTIONS

When installing the KV® 8000 slide, it is recommended that both the right and left cabinet member brackets be installed first. When this is done the slides can be attached to the cabinet member brackets with the hold-in detent facing forward (figure 1).

The remaining two brackets can be attached to the storage device and set into place on the slides. When unit is completely installed it is recommended that the eight bracket locking screws be installed.

1. Mark a line at least 1/4" in from the right side of the cabinet opening and parallel to the cabinet side.
2. Locate a point on this line 1.00" back from the desired front of the slide.
3. Using #8 pan or round head screws, mount the cabinet member bracket through the first hole at this point. **NOTE: For maximum strength, ensure that the hold-in bumper is installed at the front of the drawer.**

4. Mount the left hand slide similarly, locating the screw centerline of the cabinet member bracket at least 1/4" in from the left side of the opening.
5. Keeping the right and left hand slides parallel, install the remainder of the cabinet member screws. **NOTE: When using soft materials, such as particle board, replace rear cabinet mounting screws with through bolts.**
6. Attach the slides to the right and left cabinet member brackets by sliding the bracket tabs through the belt loops located on the side of the slide. The bracket release lever will snap into place.
7. Attach the two remaining two brackets to storage device. When this is done the storage device can be installed onto the slides.
8. Attach the 8 bracket locking screws to secure the unit.

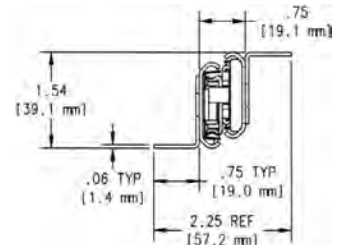

Product Undermount Storage Slide

Mounting Bracket

Clearance .75" Slide only

Load Rating 130 lbs.

Height 1.54"

Finish Anochrome

Travel Slide Length + 0.83"

Action Telescopic

Hardware 16 - #8 x 5/8 pan head mounting screws  
8 - 8 x 3/16 pan head bracket locking screws

Sizes 12", 14", 16", 18", 20", 22", 24", 26" and 28"

Packaging Poly pack (8000P)  
All Sizes, 5 pr/ctn.



## CUTTING BOARDS

### MARCO BREADBOARDS/CUTTING BOARDS

Made From Alder

Edge grained hardwood pull-out breadboards have grooved finger pulls at each end and are reversible. All boards are sealed against moisture. All 3/4" thick Alder pull-out breadboards. Stocked with Alder, Oak or Maple finger pull ends.



Sealed finish prevents problems due to swelling and binding and maintains a cleaner surface for food.

Code	Size	Finger Pull	End	Ctn	List/ea
BB1222	12" x 22"	Alder	Alder	12	\$ 36.39
BB1422	14" x 22"	Alder	Alder	12	41.70
BB1622	16" x 22"	Alder	Alder	6	66.68
BB1622-OA	16" x 22"	Oak	Oak	6	73.01
BB1822	18" x 22"	Alder	Alder	6	76.72
BB1822-M	18" x 22"	Maple	Maple	6	62.00
BB1822-OA	18" x 22"	Oak	Oak	6	54.87
BB2422	24" x 22"	Alder	Alder	6	93.33
BB2422-M	24" x 22"	Maple	Maple	6	84.33
BB2422-OA	24" x 22"	Oak	Oak	6	104.94

### HOUCK BREADBOARD SLIDES

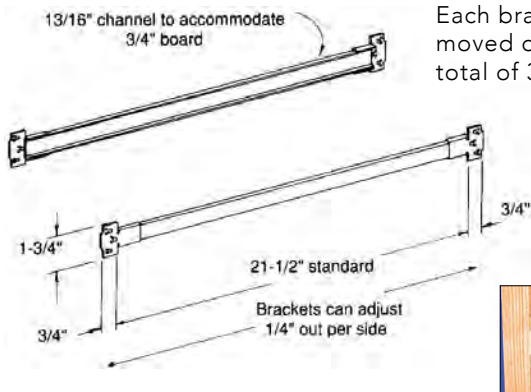

Each bracket may be moved out 3/8" for a total of 3/4" extension.

Side Mounted. 50 sets/Ctn.

Code	Description	List/set
BB SLIDE	Breadboard slides, 30 lbs/st	\$ 9.52

### REV-A-SHELF® DOOR MOUNT CUTTING BOARD RACK WITH WOOD CUTTING BOARD

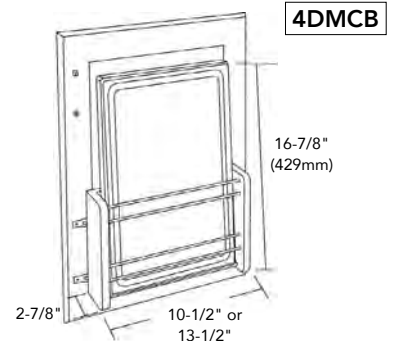

4DMCB-18

4DMCB-15	Width	Depth	Height
Rack	10-1/2"	2-7/8"	8"
Board	7-3/4"	1-1/4"	16"



4DMCB-18

Rack	13-1/2"	2-7/8"	8"
Board	10-3/4"	1-1/4"	16"

Adjustable Door Mounting Brackets add up to 5" of adjustability to each side for mounting to back of cabinet door.

Includes: Maple hardwood cutting board (mineral oil treated), Door Rack and screws.

Both units: 2-7/8" Depth and 16-7/8" Height

Code	Base	Width	List/ea
4DMCB-15	15	10-1/2"	\$ 108.12
4DMCB-18	18	13-1/2"	122.13

### COMBINATION KNIFE HOLDER/CUTTING BOARD



Includes:

- Knife organizer
- Wood cutting board
- Full extension slides (std and soft close avail)
- mounting hardware

No drawer box needed!  
Just add a drawer front.

Code	Dimensions	List/ea
4KCB-24H-1	20-1/2" W x 22-1/4" D x 5" H	\$ 293.39

#### Soft Close

4KCB-18HSC-1	15" W x 21-3/4" D x 4-3/8" H	311.20
4KCB-21HSC-1	18" W x 21-3/4" D x 4-3/8" H	343.19
4KCB-24HSC-1	21" W x 21-3/4" D x 4-3/8" H	369.81





## CUTTING BOARDS

### CUT-OUT CUTTING BOARD DRAWER



**4WCCB**

No drawer box needed!  
Just add a drawer front.

- Designed for 18" cabinet drawers
- Natural maple construction with semi-gloss finish
- Removable cut-out cutting board and funnel insert
- Full extension, 110 lb concealed soft close slides
- Mounting brackets included

Code	Dimensions	List/ea
4WCCB-18HSC-1	15"W x 21-3/4"D x 4-5/16"H	\$ 309.14

### OMEGA HARDWOOD CHINA DISPLAY RACKS



**P1100**

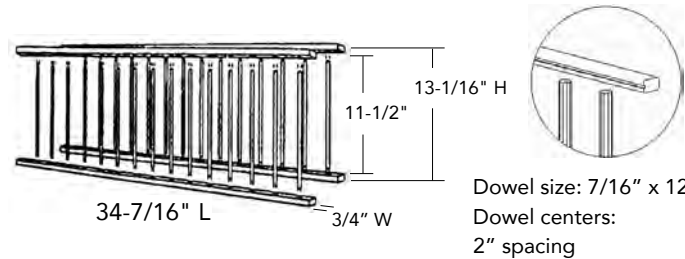

Versatile design allows for trim capability for small size applications. Kit consists of two top and two bottom predrilled rails with 32 vertical fluted dowels, spaced on 2" centers. Convenient design offers 3 removable dowels for easy cleaning.

Code	Description	List/ea
P1100MUF2	Maple, Unfinished	\$ 80.60
P1100QUF2	Alder, Unfinished	71.71

## STEMWARE RACKS

### OMEGA STEMWARE RACKS



Solid wood stemware rack is designed to accommodate most sizes and styles of stemware. Sanded and ready-to-finish. Depth: 12".

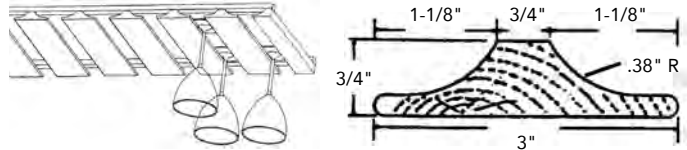

Code	Rows	W x D	Wood	List/ea
S9600OUF1	4	18" x 12"	Oak	\$ 58.61
S9600MUF1	4	18" x 12"	Maple	68.05
S9620MUF1	7	30" x 12"	Maple	93.43
S9620QUF1	7	30" x 12"	Alder	95.76
S9620CUF1	7	30" x 12"	Cherry	143.28
S9630OUF1	8	36" x 12"	Oak	103.19
S9630MUF1	8	36" x 12"	Maple	104.86
S9630CUF1	8	36" x 12"	Cherry	172.64
S9630QUF1	8	36" x 12"	Alder	112.63

### REV-A-SHELF STEMWARE HOLDER

Features heavy gauge wire construction and a hidden mounting plate. Easy to install.



**3150:** Single rack holds up to 3 glasses. Dims: 4-1/4"W x 11"D x 1-1/2"H

**3450:** Quad rack includes (4) single racks fused together for ease of installation. Holds up to 12 glasses. Dims: 17"W x 11"D x 1-1/2"H

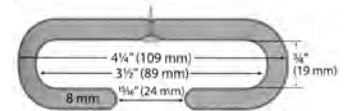

Code	Width	Finish	List/ea
3150-11ORB	4-1/4"	Oil Rubbed Brz	\$ 13.99
3150-11SN	4-1/4"	Satin Nickel	12.26
3150-11CR	4-1/4"	Chrome	10.78
3450-11ORB	17"	Oil Rubbed Brz	\$ 54.74
3450-11SN	17"	Satin Nickel	47.69
3450-11CR	17"	Chrome	47.06



## WINE RACKS

### OMEGA WINE RACK LATTICE

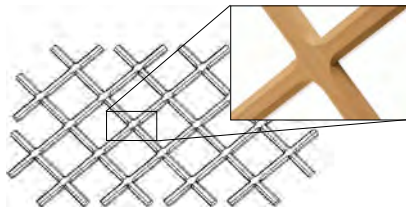

3-3/4" wide squares

Interlaced and flush-fit for a professional appearance. With chamfered edges. Sold in pairs (2 panels) without face frames. Can be cut to desired dimensions. 3-3/4" wide squares.

Code	Size	Wood	List/pr
L3380OUF9	17" x 29"	Oak	\$ 109.69
L3380MUF9	17" x 29"	Maple	112.66
L3380QUF9	17" x 29"	Alder	118.52
L3360OUF9	17" x 36"	Oak	125.83
L3360MUF9	17" x 36"	Maple	144.96
L3360QUF9	17" x 36"	Alder	136.62
L3340OUF9	23" x 29"	Oak	146.84
L3340MUF9	23" x 29"	Maple	179.43
L3340QUF9	23" x 29"	Alder	167.74
L3320OUF9	23" x 42"	Oak	194.04
L3320MUF9	23" x 42"	Maple	207.87
L3320QUF9	23" x 42"	Alder	235.41

### OMEGA WINE BOTTLE RACK

Made of Solid Hardwood

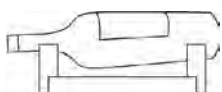

Holds 11 bottles



Both members 3/4" thick

48" Overall Length

Front top edge is bullnosed w/ 3/8" radius

Products are both pre-rabbeted 3/8" x 3/8" on bottom  
No Bullnose on back member

Code	Wood Specie	List/set
S9200CUF1	Cherry	\$ 91.80
S9200MUF1	Maple	73.79
S9200OUF1-RO	Red Oak	67.81

## APPLIANCE GARAGE

### APPLIANCE GARAGE - For Corners

Omega National



Solid Wood Corner Appliance Garage

AG-100CS

- Solid wood tambour door mounted to solid wood face frame
- End panels are veneer faced and backed on 3/8" MDF, using plain-sliced veneer
- Doweled joints
- Spring Tension Track System (ST-2)
- Smooth, non-binding operation
- Prefabricated for simple installation
- Easily Trimmable

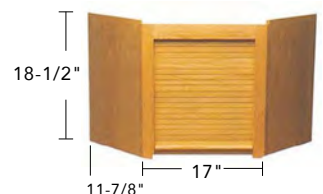

Code	Wood	List/ea
AG-100CSM	Maple	\$ 189.20

## TAMBOUR

### TAMBOUR TRACK KITS

For Custom Appliance Garages



ST-2

ST-2: Face Frame Mount

System includes tension spring, wood dowel donut(s) and plastic guide rails. Controls tambour doors up to 36"W x 19"H. Doors are easily controlled from the top to bottom, glides smoothly. Easy to install. Track: 1/4". Recommended Tambour: 3/16" thick.

Code	Width	Height	List/kit
ST2-16AL	16"	17-1/2"	\$ 21.80
ST2-24AL	24"	17-1/2"	26.73
ST2-36AL	36"	17-1/2"	27.87

### MARCO PLASTIC TAMBOUR TRACK & CURVES

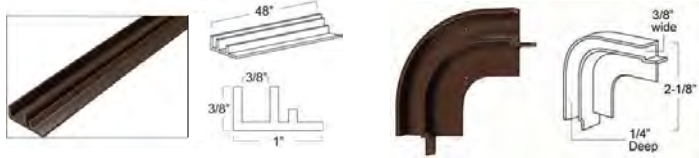

4T54 Track

4C55 Curve

For 1/4" to 5/16" material. Fits all Marco tambour profiles. Brown in color.

Code	Description	Ctn	List/ea
4T54	Track 4' length	1 ea.	\$ 9.50
4C55	Corner for Track	1	5.54

### MARCO TAMBOUR WOOD

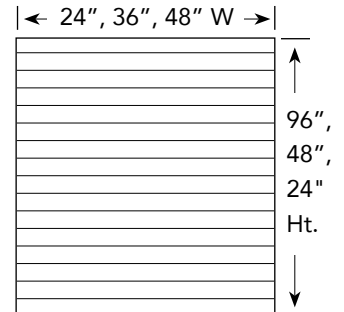

Solid Wood. 1/4" thick, 3/4" wide. Grain of slats run way of the width.

Flat with Radius Profile:

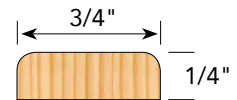

Code	Wood	Size	List/ea
AT36	Alder	36" W x 96" H	\$ 519.55
OT36	Oak	36" W x 96" H	600.18
OT48	" "	48" W x 96" H	593.85
OT4824	" "	24" W x 48" H	152.39
CT4836	Cherry	36" W x 48" H	383.32
CT2448-FR	" "	48" W x 24" H	231.76
MT4848FR	Maple	48" W x 48" H	519.60
MT2448-FR	" "	48" W x 24" H	261.01

Half Round Profile:

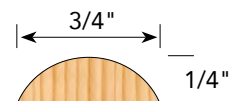

Code	Wood	Size	List/ea
AT36HR	Alder	36" W x 96" H	\$ 519.20
MT4848HR	Maple	48" W x 48" H	536.70



## LAZY SUSANS

### REV-A-SHELF: FULL CIRCLE SHELF SETS

Polymer Lazy Susans



Uses same proven hardware as all-metal sets with reinforced polymer shelves that are as rigid as metal under load.

**6012 Two-Shelf Set:** Includes two shelves, hardware, and instructions. Telescoping post is 22-1/2" and will fit cabinets with inside dimensions of 24" to 31" high. Can be cut.

Code	Diameter	Color	List/set
6012-18-11-52	18"	White	\$ 79.76
6012-20-11-52	20"	White	88.30
6012-24-11-52	24"	White	90.41
6012-28-11-52	28"	White	112.71

\*For 32" Dia. see 6072 Shelf sets on pg.1606.

**6013 Three-Shelf Set:** Includes three shelves, hardware & instructions. Telescoping post will fit cabinets with inside dimensions of 38" to 46". Can be cut.

Code	Diameter	Color	List/set
6013-18-11-526	18"	White	\$ 118.75
6013-20-11-526	20"	White	132.67

#### Extra Center Post, 72"

6000-05-7200-2

List \$ 63.91/ea.

### REV-A-SHELF: PIE CUT SHELF SETS

Polymer Lazy Susans



Reinforced polymer shelves are as rigid as metal under load. Includes: two shelves, hardware, and instructions. Telescoping post is 22-1/2" and will fit cabinets with inside dimensions of 26" to 32" high. (Cannot be cut). Can be door mounted.

#### Pie-Cut Cabinet Dimension

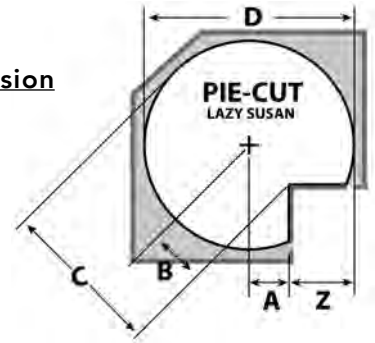

Shelf Dia.	A	B	C	D	Z	System
24"	1-3/8"	1-15/16"	13-15/16"	24"	10-9/16 + 1/8" gap	1" Dep
28"	3"	4-1/4"	18-1/4"	28"	11 + 1/8" gap	1" Dep

Code	Diameter	Color	List/set
6942-24-11-52	24"	White	\$ 116.17
6942-24-15-52	24"	Almond	116.17
6942-28-11-52	28"	White	135.75
6942-28-15-52	28"	Almond	135.75

# LAZY SUSANS



## REV-A-SHELF KIDNEY SPECIFICATIONS

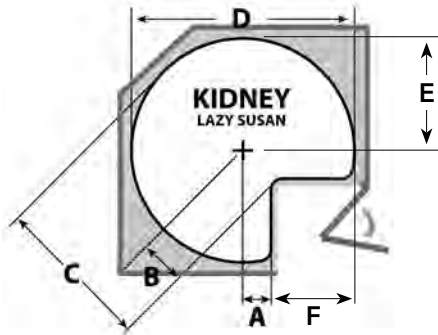

Shelf Dia.	A	B	C	D	E	F
18"	1-3/4"	2-13/16"	11-13/16"	18"	9"	6-13/16"
24"	1-1/2"	2-5/16"	14-5/16"	24"	12"	10-1/6"
28"	3"	4-11/16"	18-5/8"	28"	14"	10-9/16"
32"	4-1/4"	6-7/16"	22-7/16"	32"	16"	11-3/8"

### 18" Diameter

Storage area: 1.38 Sq Ft.  
 Load Capacity: 19.2 lbs.  
 Cab Depth: 11-3/4"  
 Cab Opening: 6-13/16"

### 24" Diameter

Storage area: 2.51 Sq Ft.  
 Load Capacity: 37.6 lbs.  
 Cab Depth: 14-1/2"  
 Cab Opening: 10-1/16"

### 28" Diameter

Storage area: 3.2 Sq Ft.  
 Load Capacity: 48 lbs.  
 Cab Depth: 18"  
 Cab Opening: 10-9/16"

### 32" Diameter

Storage area: 4.2 Sq Ft.  
 Load Capacity: 63 lbs.  
 Cab Depth: 21-1/4"  
 Cab Opening: 11-3/8"

## REV-A-SHELF: KIDNEY TWO SHELF SETS



Shelves rotate independently. Telescoping Chrome plated center shaft fits cabinets from 26" to 31". Can be cut for shorter cabinets. Polymer bushings are self-lubricating for smooth, quiet action. Positioner assembly supports each shelf and provides centering from 30° either side of original position. Set includes 2 shelves and all hardware.

Code	Diameter	Color	List/set
6472-18-11-52	18"	White	\$ 122.97
6472-24-11-52	24"	White	133.51
6472-24-15-52	24"	Almond	134.24
6472-28-11-52	28"	White	143.07
6472-28-15-52	28"	Almond	158.68
6472-32-11-52	32"	White	172.43
6472-32-15-52	32"	Almond	165.00

## REV-A-SHELF VALUE LINE KIDNEY SUSANS

- Twist-N-Lock Telescoping Shaft
- Molded Polymer Hubs/bearings (instead of metal)
- Independently rotating



Code	Diameter	Color	List/set
3472-24-11-52	24"	White	\$ 84.34
3472-28-11-52	28"	White	91.02
3472-32-11-52	24"	White	110.84

## REV-A-SHELF: KIDNEY SINGLE SHELF SETS

One polymer shelf with positioner assembly, 5" shaft & screws.



6421  
 Single Shelf

Code	Diameter	Color	List/set
6421-32-11-52	32"	White	\$ 87.07



## PANTRY LAZY SUSANS

### REV-A-SHELF FULL CIRCLE PANTRY SETS

Independently Rotating Shelves

Full Circle Pantry Sets are packaged complete with hardware.

Features chrome-plated tubing, telescoping shafts, self-centering and independently rotating shelves, and single screw height adjustment. Shelves are white or almond polymer.

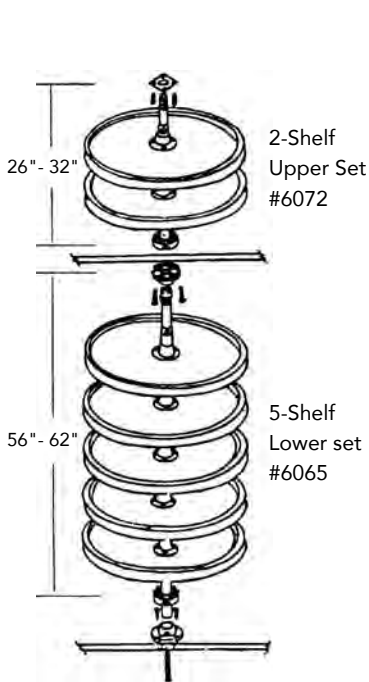

2-Shelf Set	Description	List/st
6072-16-11-52	16" Dia, White	\$ 137.21
6072-20-11-52*	20" Dia, White	143.33
6072-24-11-52*	24" Dia, White	172.72
6072-32-11-52	32" Dia, White	211.08
6072-32-15-52	32" Dia, Almond	211.30

5-Shelf Unit	Description	List/st
6065-16-11-52	16" Dia, White	371.20
6065-18-11-52*	18" Dia, White	365.05

### REV-A-SHELF "D" SHAPED PANTRY SETS

Independently Rotating Shelves

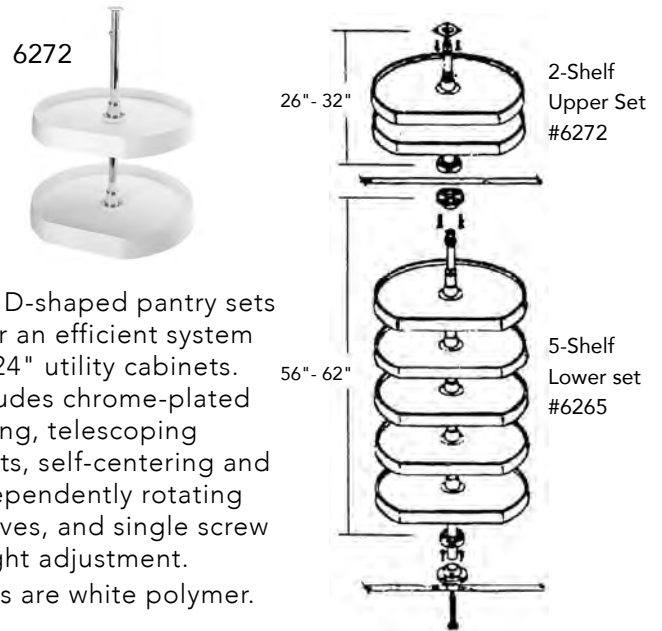

The D-shaped pantry sets offer an efficient system for 24" utility cabinets. Includes chrome-plated tubing, telescoping shafts, self-centering and independently rotating shelves, and single screw height adjustment. Trays are white polymer.

2-Shelf Set	Description	List/st
6272-20-11-52	20" Dia, White	\$ 158.66
3-Shelf Set**	20" Dia, White	215.87
5-Shelf Set	22" Dia, White	374.54

\*\* Same dimensions and hardware as 6272 but with a third shelf and telescoping shaft accomodates 38" - 46".

### REV-A-SHELF "D" SHAPED PANTRY SETS

Dependent Rotating Shelves



7013  
 20" Diameter  
 3-Shelf Set

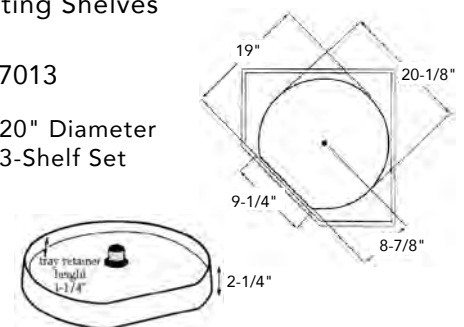

Three-shelf set has dependent rotating shelves. For frame or frameless diagonal wall cabinets. Telescoping post adjusts 38" to 46". White finish.

Code	Description	List/st
7013-20-11-526	20" Dia, White	\$ 130.04

## BANDED WOOD LAZY SUSANS

### BANDED WOOD LAZY SUSANS

Banded Wood Lazy Susans have a laminated hardwood rim with a dowelled butt joint. Clear finish.

Chrome posts have an almond polymer hub. Rim is 5/16" higher than the wood classic (4WLS472) series.

#### Features:

- 2" Banded Wood Rim
- Almond Polymer Hubs
- 5/8" Thick Maple Tray Bottom
- Chrome posts

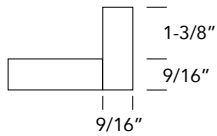

Laminated  
Hardwood  
Rim



Doweled  
Butt Joint

### KIDNEY SHAPE BANDED WOOD



LD-4BW-401

Single shelf has attached steel swivel bearing and stop on back of tray.



LD-4BW-472

2-Shelf sets are adjustable from 26 - 31" in height.

Code	Dia	Shelves in Set	List/ea
LD-4BW-401-28SBS-1	28"	1	\$ 164.85
LD-4BW-401-32SBS-1	32"	1	191.36
LD-4BW-472-24-1	24"	2	238.28
LD-4BW-472-28-1	28"	2	281.21
LD-4BW-472-32-1	32"	2	311.72

### PIE-CUT BANDED WOOD

Adjustable from 26 - 32" in height.

LD-4BW-942



Code	Dia	Shelves in Set	List/ea
LD-4BW-942-28-1	28"	2	\$ 301.20



### FULL ROUND BANDED WOOD

Single shelf has attached swivel bearing.



LD-4BW-001



LD-4BW-062



LD-4BW-063

2-Shelf sets are adjustable from 26 - 31" in height.  
 3-Shelf sets are adjustable from 38 - 46" in height.

Code	Dia	Shelves in Set	List/ea
LD-4BW-001-18SB-1	18"	1	\$ 105.28
LD-4BW-001-20SB-1	20"	1	105.28
LD-4BW-001-24SB-1	24"	1	139.58
LD-4BW-001-28SB-1	28"	1	153.44
LD-4BW-001-32SB-1	32"	1	179.58
LD-4BW-062-18-1	18"	2	196.92
LD-4BW-062-20-1	20"	2	198.77
LD-4BW-062-24-1	24"	2	235.93
LD-4BW-062-28-1	28"	2	274.94
LD-4BW-062-32-1	32"	2	338.87
LD-4BW-063-1836-1	18"	3	299.71
LD-4BW-063-2036-1	20"	3	303.92

### D-SHAPE BANDED WOOD



LD-4BW-262



LD-4BW-263

2-Shelf sets are adjustable from 26 - 31" in height.  
 3-Shelf sets are adjustable from 38 - 46" in height.

Code	Dia	Shelves in Set	List/ea
LD-4BW-262-20-1	20"	2	\$ 192.46
LD-4BW-262-32-1	32"	2	314.95
LD-4BW-263-2036-1	20"	3	295.00



## WOOD LAZY SUSANS

### NATURAL WOOD LAZY SUSANS

- 2-3/8" Steam Bent Hardwood Rim
- 9/16" Thick Maple-Ply Tray Bottom
- Chrome Hardware
- Doweled (2) Butt Joint
- Aluminum Bearings

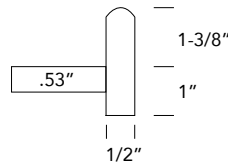

Rim: 2-3/8"

### KIDNEY SHAPE LAZY SUSAN

Natural Wood



LD4NW472

Code	Description	List
LD4NW472-28-1	2 Shelf, 28" Dia.	\$ 422.45
LD4NW472-32-1	2 Shelf, 32" Dia.	468.54

### FULL CIRCLE WOOD CLASSIC SINGLE SHELF

With Swivel Bearing Attached



4WLS001  
 Single Maple Tray with Swivel Bearing

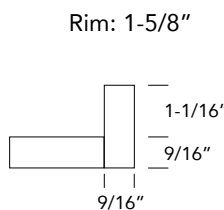

Rim: 1-5/8"

The thick high-density multi-ply tray with 1-5/8" high solid wood rim has a UV-cured clear coat finish. Fast top mounting to a shelf or flat surface via access holes with trim plugs.

Code	Description	List
4WLS001-18-B52	Single Shelf, 18" Dia.	\$ 126.31
4WLS001-32-B52	Single Shelf, 32" Dia.	222.46

### KIDNEY SHAPE WOOD CLASSIC SINGLE SHELF

With Swivel Bearing and Stop Installed



4WLS401

Single Maple Kidney Tray



Installed Swivel Bearing and stop on back of tray

Rim: 1-5/8"

The thick high-density multi-ply tray with 1-5/8" high solid wood rim has a UV-cured clear coat finish. Fast mounting to flat surfaces.

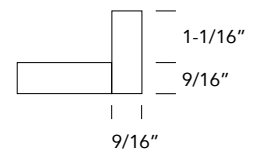

Code	Description	List
4WLS401-28-BS52	Single Shelf, 28" Dia.	\$ 209.41
4WLS401-32-BS52	Single Shelf, 32" Dia.	241.87

### CENTER SHAFT EXTENSION

Rev-A-Shelf

1" diameter, 70-1/2" long center shaft extension can be cut to size. For use with Rev-A-Shelf pantry or kidney independently rotating hardware sets when a longer shaft is needed. Must be used with bushings supplied by factory.

Code	List
6370-96-7008-26	\$ 80.28



### INDEPENDENTLY ROTATING CENTERING HARDWARE

2 Shelf Hardware Set

Dimensions:  
 26" - 32", 1" dia. shaft

Code	Description	List
6272-04-52	2 Shelf Hdwr St	\$ 123.23





## WOOD LAZY SUSANS

### REV-A-SHELF WOOD CLASSIC LAZY SUSANS

- The beauty of Maple without the worry of warping and splitting
- 1-5/8" Solid wood rim with plywood tray. Clear, durable UV cured finish
- Shelves Rotate Independently
- Sets contains 2 shelves, post and metal pivot hardware
- Telescoping chrome post accomodates 26" - 32" Inside Cabinet Height

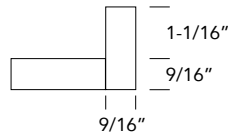

**REV-A-SHELF**  
*Wood Classics*

Featuring Chrome Hub and Hardware, metal bearings

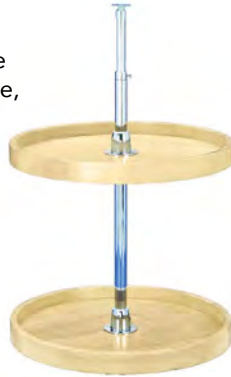

**FULL CIRCLE WOOD CLASSIC 2 SHELF SET**  
 4WLS072

Code	Diameter	List/set
4WLS072-18-52	18"	\$ 243.25
4WLS072-20-52	20"	273.97
4WLS072-28-52	28"	383.16
4WLS072-32-52	32"	396.73

**REV-A-SHELF**  
*Wood Classics*

Featuring Chrome Hub and Hardware, metal bearings

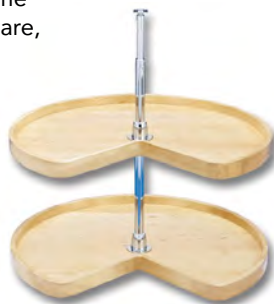

**KIDNEY SHAPE WOOD CLASSIC 2 SHELF SET**  
 4WLS472

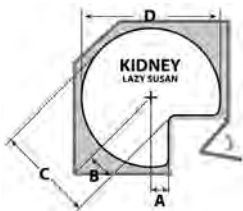

Shelf Dia.	A	B	C	D
24"	1-7/16"	2-3/8"	14-3/8"	23-15/16"
28"	2-7/8"	4-3/8"	18-1/4"	27-3/4"
32"	4-1/16"	6"	21-15/16"	31-3/4"

Code	Diameter	List/set
4WLS472-24-52	24"	\$ 334.87
4WLS472-28-52	28"	347.38
4WLS472-32-52	32"	443.25

**REV-A-SHELF**  
*Wood Classics*

**FULL CIRCLE WOOD CLASSIC 3 SHELF SET**  
 4WLS073

Includes three shelves, hardware & instructions. Telescoping post will fit cabinets with inside dimensions of 38" to 46". Can be cut. Shelves rotate independently.

4WLS073



Code	Diameter	List/set
4WLS073-18-536	18"	\$ 365.60
4WLS073-20-536	20"	403.37

**REV-A-SHELF**  
*Wood Classics*

**D-SHAPE WOOD CLASSIC 3 SHELF SET**  
 4WLS273



4WLS273



Includes three shelves, hardware & instructions. Telescoping post will fit cabinets with inside dimensions of 38" to 46". Shelves rotate independently.



Shelf Dia.	A	B	C	D
20"	8-3/8"	10-5/8"	18-3/8"	20"

Code	Diameter	List/set
4WLS273-20-536	20"	\$ 413.45

## LAZY SUSANS



### "Floating Shelf" Pole Free Lazy Susan



A new corner cabinet solution: Optimal use of storage with no space limiting center post. Trays are mounted on a horizontal support arm - hardware is virtually invisible.

- Pole-free = more storage space
- Tool-less height adjustment of the trays
- Can be used in base, pantry and wall cabinets
- Can be retrofitted into existing cabinets
- Load capacity: 60 lbs. per shelf
- Inside height min: 24-3/8"
- Maple shelf, Silver rail

#### Cabinet Dimensions

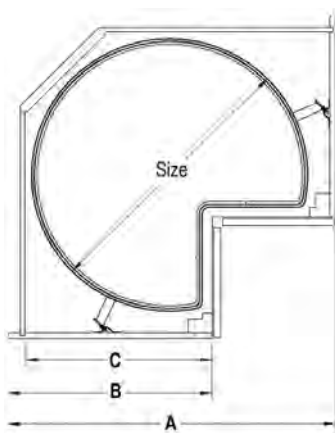

90004100 Dia: 26-3/4"

90008840 Dia: 32"

Pack: 1 set consists of  
 2 Trays,  
 2 support arms,  
 2 wall brackets  
 and mounting  
 instructions.

Code	A	B	C	List/ea
90004100	31-1/2"	21-1/4" - 24"	19-1/4"	\$ 489.21
90008840	35-1/2"	21-1/4" - 24"	19-1/4"	534.00

### Shelf Mount Lazy Susan:

Single Tray and Lazy Susan Bearings installed on cabinet shelf.



No Space  
 Limiting  
 Center Post



See previous pages for shelf mount trays and bearings.

### TRIANGLE LAZY SUSAN BEARINGS



3C, 4C, 6C



12C

Bearings attach easily to second surface even though hidden by first surface. Only 5/16" thick. Can be recessed to reduce clearance to 1/8". Large ball-bearing race for maximum stability has full load of precision ground ball-bearings. Unit is pre-assembled.

Code	Dia.	Max Load	Shelf Dia.	Ctn	List/ea
3C	3"	200 lbs.	18"	100	\$ 1.72
4C	4"	300	25"	75	3.78
6C	6"	500	30"	100	4.89
12C	12"	1000	40"	25	18.30



# LAZY SUSANS

## CHROME WIRE KIDNEY LAZY SUSAN

5472 Series



5472



Heavy gauge chrome. Independently rotating shelves. Telescoping shaft (9-1/4" upper, 22-1/2" lower) to accommodate 26"- 32" Inside Cabinet Height. Features durable 1" chrome shaft and hubs. Rim Height: 2.42".

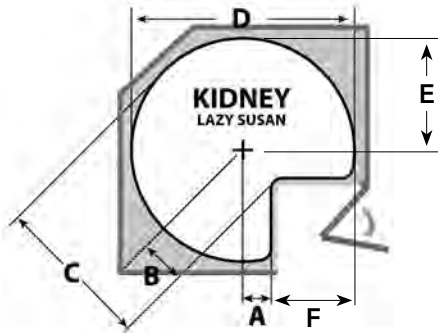

Shelf Dia.	A	B	C	D	E	F
28"	2-7/8"	4-3/16"	18-1/4"	28-1/8"	14"	10-5/8"
32"	2-7/8"	4-3/16"	20-1/4"	32-1/8"	16"	11-1/2"

### 28" Diameter

Storage area: 3.2 Sq Ft.  
Cab Depth: 18-1/16"  
Cab Opening: 10-5/8"

### 32" Diameter

Storage area: 4.2 Sq Ft.  
Cab Depth: 21-3/16"  
Cab Opening: 11-1/2"

Code	Description	List/ea
5472-28CR	Chrome Kidney Shape, 28" Dia.	\$ 390.88
5472-32CR	Chrome Kidney Shape, 32" Dia.	433.59

# LAZY SUSAN HARDWARE

## SALICE PIE CUT HINGE

Self-Closing

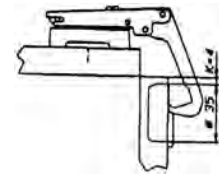

Patented adjustment features: Save time with this special hinge. Opening angle of the first door: 70°. Allows standard drilling of door for pie-cut cabinet. Uses 3mm Salice plate on a 3/4" door.

Code	Description	Ctn	List/ea
C2RYA99	Dowelled	150 ea.	\$ 9.05
C2PYA99	Screw-On	150	7.80

## GRASS TIOMOS PCC

Pie Cut Corner Cabinet Hinge



- 3 dimensional adjustment with suitable baseplate
- For door thicknesses 14 to 22mm
- Used in conjunction with Tiomos 160° hinges



Overlay / Cranking 00 / 45mm Drilling Pattern, Screw-On

Code	Description	Ctn	List
T45-517	Pie Cut hinge, Self-Close, Screw-on	150	\$ 10.31

## GRASS PIE-CUT CORNER HINGE



13128

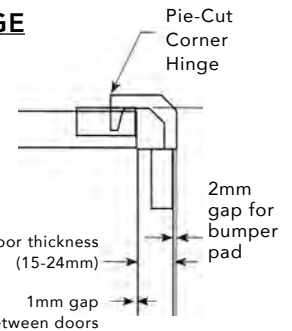
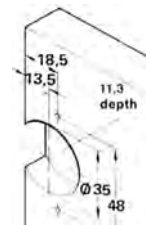

With two identical recess bosses: ø35mm, 11.3mm depth. Max. door opening angle: 78°. For door variable thickness from 15-24mm. Zinc alloy, nickel plated. Screw-on. Polybagged: 2 hinges, 1 magnetic catch, 1 strike, and instructions.

Code	Finish	Ctn	List/bg
13128	Nickel Plate	50 bgs.	\$ 51.89

## LAZY SUSAN BEARINGS

### TRIANGLE LAZY SUSAN BEARINGS



3C, 4C, 6C



12C

Bearings attach easily to second surface even though hidden by first surface. Only 5/16" thick. Can be recessed to reduce clearance to 1/8". Large ball-bearing race for maximum stability has full load of precision ground ball-bearings. Unit is pre-assembled.

How to install and mount

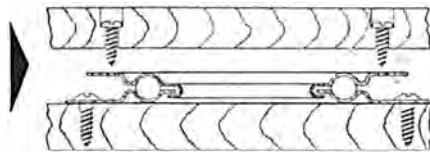

Code	Dia.	Max Load	Shelf Dia.	Ctn	List/ea
3C	3"	200 lbs.	18"	100	\$ 1.72
4C	4"	300	25"	75	3.78
6C	6"	500	30"	100	4.89
12C	12"	1000	40"	25	18.30

## BLIND CORNER STORAGE

**REV-A-SHELF®**  
*Wood Classics*  
**REV-A-SHELF WOOD**  
**HALF MOON GLIDE-OUT**  
 4WLS882



Two Shelf  
 Glide-Out  
 System

Rim: 1-5/8"

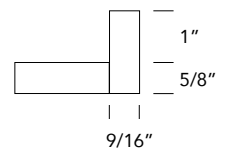

Made of 5/8" thick high-density multi-ply tray and 1-5/8" high solid wood rim that is protected by a UV clear-coat finish. Features pivot and pull slides that can be RH or LH. Contains: 2 Shelves, slides, Euro and standard brackets, assembly hardware and instructions.

Code	Size	Min opening	List
4WLS882-32-570	32"	12"	\$ 409.37
4WLS882-35-570	35"	15"	469.77
4WLS882-38-570	38"	18"	538.80

**REV-A-SHELF NATURAL WOOD**  
**HALF MOON GLIDE-OUT**

LD4NW882

Rim: 2-3/8"

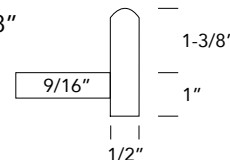

Two Shelf  
 Glide-Out  
 System

- Steam Bent Hardwood - 2-3/8" Rim
- Non-handed: LH or RH
- UV cured clear coat finish
- Smooth pivot & extension
- Two Shelf Glide-Out

Code	Size	Min opening	List
LD4NW882-32-1	32"	12"	\$ 421.08
LD4NW882-35-1	35"	15"	505.58
LD4NW882-38-1	38"	18"	520.14

## BLIND CORNER STORAGE



### REV-A-SHELF HALF MOON PIVOT SHELF SETS

Polymer 2-Shelf Sets

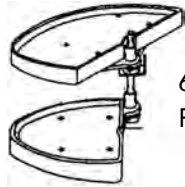

6842  
 Pivot Only



Half Moon polymer pivot shelves. Two shelves per set. All hardware and installation instructions are included. Overall Height: 17".

Code	Min opening	Color	List/st
6842-31-11-570	13-1/4"	White	\$ 194.45
6842-33-11-570	16-1/8"	White	199.40
6842-39-11-570	19-1/4"	White	231.60

### REV-A-SHELF HALF MOON GLIDE-OUT PIVOT SHELVES

Polymer 2-Shelf Sets



6882  
 Pivot and Slide Set

Half moon glide-out polymer pivot shelves. Shelves individually slide out as well as pivot. Two shelves per set. Each set contains all hardware, slides, and installation instructions. Overall Height: 17".

Code	Min opening	Color	List/st
6882-31-11-570	13-1/4"	White	\$ 256.93
6882-31-15-570	13-1/4"	Almond	285.75
6882-33-11-570	16-1/8"	White	258.83
6882-33-15-570	16-1/8"	Almond	286.76
6882-39-11-570	19-1/4"	White	285.12
6882-39-15-570	19-1/4"	Almond	313.35

### Specifications for Rev-A-Shelf Half Moon Trays

#### Framed Cabinet

Dimensions (A, B & C) are minimums. 31" tray shown in diagram. Larger trays do not have "flat" in circular arc.

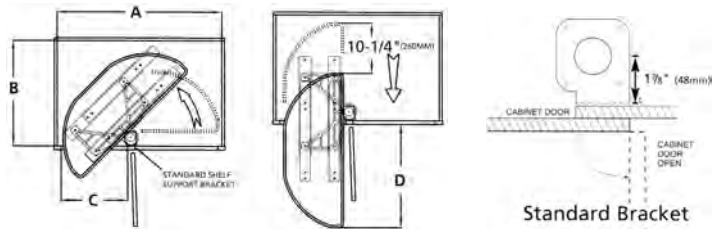

Tray Size	A	B	C	D
31"	33-11/16"	21-1/2"	13-1/4"	21-1/16"
33"	34-5/16"	18-9/16"	16-1/8"	24-1/16"
39"	40-11/16"	21-13/16"	19-1/4"	27-3/8"

#### Frameless Cabinet (Euro)

Dimensions (A, B & C) are minimums. 39" tray shown in diagram.

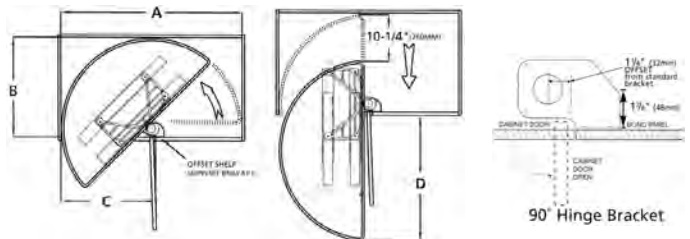

Tray Size	A	B	C	D
31"	32-13/16"	21-1/2"	15"	21-1/16"
33"	33-3/16"	18-9/16"	17-7/16"	24-1/16"
39"	39-7/8"	21-13/16"	20-3/4"	27-3/8"

## BLIND CORNER STORAGE



### CORNERSTONE MAXX



Maple w/ Silver Railing - RH unit

- Can be installed with drawer above
- The shelves can be moved in and out independently and do not obstruct the adjacent cabinet
- Rapid **single** post install showcases floating design
- Tool-free assembly of shelves onto supports
- Simple height adjustment (Min. 19-5/8")



White w/  
Silver Railing



Lava w/  
Grey Railing

#### One Shop's Experience:

"This installed so EASY and I really like it. Let's use this from now on."

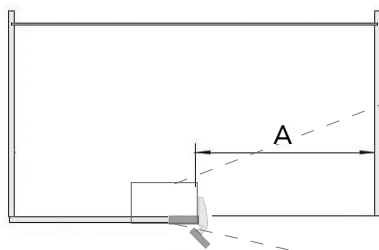

Min Opening (including door & hinge)

Size	A	Size	A
1	14"	3	18"
2	16"	4	22"

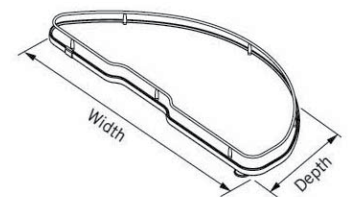
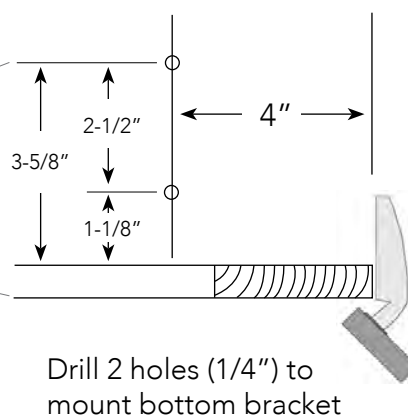

Product Dimensions

Size	Width	Depth
1	29"	13"
2	33"	14-3/4"
3	37"	16-3/4"
4	39"	18-3/16"

**What to Order** For one complete set, order 1 set of shelves and 1 hardware kit.

#### Shelves (required)

Maple	White	Lava Grey	Size #	List/set
90007611	90007515	90007554	1 LH	\$ 224
90007612	90007514	90007555	1 RH	224
90007613	90007517	90007556	2 LH	234
90007614	90007516	90007562	2 RH	234
90007615	90007513	90007558	3 LH	250
90007616	90007442	90007559	3 RH	250
90007617	90007519	90007560	4 LH	283
90007618	90007518	90007561	4 RH	283

#### Hardware Kit (required)

Code	Description	List/set
90007432	Universal Hardware Kit (non-handed)	\$ 571



Scan here for Cornerstone Maxx Installation video at [macpac1.com/videos.html#vauthsagel](http://macpac1.com/videos.html#vauthsagel)

## BLIND CORNER STORAGE

### **SALICE** Fly Moon KITCHEN SPACE ORGANIZERS



LH Shown

- Shelves pull out independently
- Easy to Install
- Height adj. shaft 26" - 32"
- Maple melamine tray bottoms with Champagne railing
- Load Cap: 44 lbs /shelf
- Order Shelf set and hardware separately, choose RH or LH

Code	Hand	Min. Opening	Depth	Width	Height
QFLY-14-RH	Right	13-5/8"	16-1/32"	29"	3-3/8"
QFLY-14-LH	Left	13-5/8"	16-1/32"	29"	3-3/8"
QFLY-16-RH	Right	16"	17-3/8"	32-3/16"	3-3/8"
QFLY-16-LH	Left	16"	17-3/8"	32-3/16"	3-3/8"
QFLY-21-RH	Right	21"	18-3/4"	38-7/16"	3-3/8"
QFLY-21-LH	Left	21"	18-3/4"	38-7/16"	3-3/8"

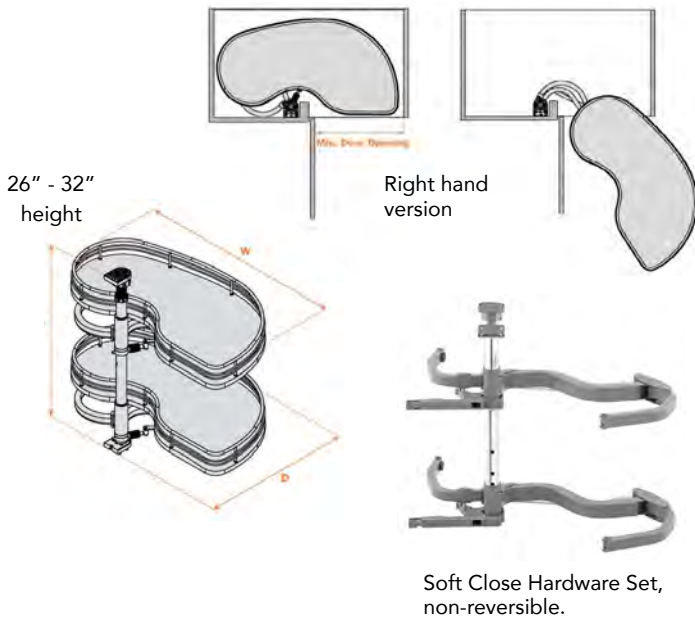

26" - 32"  
 height

Right hand  
 version

16

#### Order 1 Shelf Set (choose handing) & 1 Hardware Set

Code	Description	List
QFLY-14-LH/RH	2 shelf st, Fly Moon, 29" W	\$ 320.85
QFLY-16-LH/RH	2 shelf st, Fly Moon, 32" W	358.60
QFLY-21-LH/RH	2 shelf st, Fly Moon, 38" W	424.35
QFLY-LH or RH	Soft Close Hdwr Set, RH or LH	460.57

### ELITE TWO-TIER BLIND CORNER ORGANIZER



This blind corner optimizer has sliding top shelves that work independently from the lower shelves. Designed for 15" and 18" blind corner cabinet opening, this two-tier accessory comes with solid bottom shelving in natural maple. Non-handed design installs in either left or right-handed applications and features chrome-plated round wired accents, full-extension, ball-bearing soft-close slides. Constructed with heavy-duty materials.

#### Dims:

53PSPE-15SC-MP:	26-1/4" W x 20-1/4" D x 21" H
53PSPE-18SC-MP:	32-1/4" W x 20-1/4" D x 21" H

Code	Description	MCO	List/ea
53PSPE-15SC-MP	Elite Two-Tier Blind Corner Organizer	15"	Avail. 07/23
53PSPE-18SC-MP	Elite Two-Tier Blind Corner Organizer	18"	



## BLIND CORNER STORAGE



### COR FOLD

Made In Germany. 2 Sizes.

Soft Close

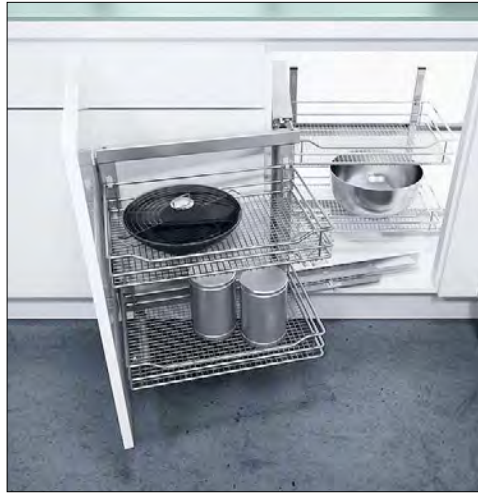
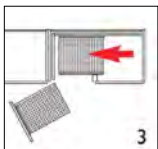
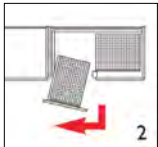
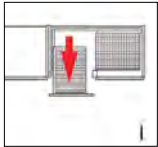

Left Hand Installation shown.

When opening, front baskets swing sideways for free access to rear baskets. Silent and Smooth soft-close action.

- Smooth soft close system
- Easy assembly of door fronts with central ht. adjustment
- Independent width door mount bracket
- Height adjustable top baskets, Inside ht. min. 21-3/8"
- Tool-less door attachment
- Load capacity: Door basket - 17.6 lbs.  
Cabinet basket - 21 lbs.
- Chrome Finish / Frame Silver powder coat

Code	Cab Width A	Door Opening B
90004164	33"	14-1/2" - 16-1/2"
90004165	33"	14-1/2" - 16-1/2"
90003890	36"	16-1/8" - 22-3/8"
90003891	36"	16-1/8" - 22-3/8"

Cabinet Dimensions

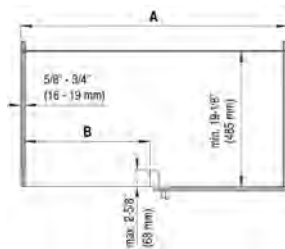

Packing: 1 set/box,  
Includes all parts, 4 baskets and instructions

Code	Hand	Door Width	List
90004164	RH	15-3/4" - 17-3/4"	\$ 746.37
90004165	LH	15-3/4" - 17-3/4"	746.37
90003890	RH	17-3/4" - 23-1/2"	767.35
90003891	LH	17-3/4" - 23-1/2"	768.36

Scan here for Cor Fold Installation video  
at [macpac1.com/videos.html#vauthsagel](http://macpac1.com/videos.html#vauthsagel)



### COR FLEX

Made in Germany. 3 Sizes.

Soft Close



- Easy bottom mount installation
- Non-handed
- Face frame or Euro style installation
- Load cap: 21 lb. per basket
- Saphir Chrome baskets

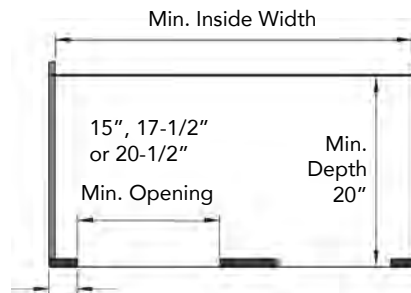

1-1/2" - 1-3/4"



Chrome Baskets

Min. Installation Height: 20-1/2"

Size	Min. Inside Width	Min. Opening	Min. Depth
1	27-1/4"	15"	20"
2	31-5/8"	17-1/2"	20"
3	34-1/2"	20-1/2"	20"

Order 1 frame and 1 basket set. Basket set consists of 2 front baskets and 2 rear baskets.

Frame	Description	List
90006112	Size 1 Frame	\$ 616.71
90006113	Size 2 or Size 3 Frame	616.88

### (CR) Saphir Chrome Basket sets\*

90006117	Size 1	Front: 11" W x 16" D Rear: 11" W x 20" D	\$ 305.32
90006255	Size 2	Front: 13-3/4" W x 16" D Rear: 12-3/4" W x 20" D	299.07
90006256	Size 3	Front: 13-3/4" W x 16-3/8" D Rear: 15-3/4" W x 20" D	303.03

\* Basket sizes are approx. Height of basket railing: 2-3/4"



## BLIND CORNER STORAGE



### **BLIND CORNER OPTIMIZER**

5PSP CR Series - Chrome

The Universal 5PSP Series maximizes space in blind corner cabinets while allowing the user full accessibility to the entire unit. The baskets are vertically adjustable, unit is easy to assemble, and installs for either left or right-handed applications.

Designed for 15" and 18" blind corner cabinet openings. Available in two or three-tier wire frame baskets. 15 lb. load cap. per baskets. Comes in standard and soft close.



Three Tier 5PSP3-18SC-CR fully extended

### Two Tier Blind Corner Optimizer



5PSP-18SC fully closed



5PSP-18SC fully extended

- Two- or Three-tier wire frame construction
- Full extension, ball bearing 100 lb. slides
- Fits most 45° blind corners with 15" or 18" opening
- Universal mounting, Non-handed
- (4) or (6) wire bottom shelves with round wire accents, 15 lb. load cap per shelf.
- Heavy-duty metal construction
- Comes fully assembled, mounts to cabinet floor

The front baskets pull out, then slide over to allow the rear baskets to be pulled out for total access to the items stored within.

### Non-handed!

#### Basket Dimensions:

(15CR) 11-3/4"W x 16-1/2"D x 3-1/2"H

(18CR) 14-3/4"W x 16-1/2"D x 3-1/2"H

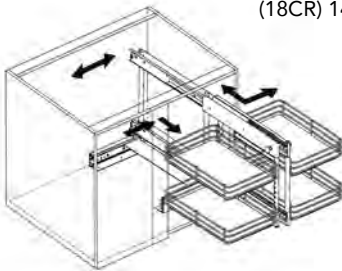

15" Min Cab Width Opening (15-CR)  
 18" Min Cab Width Opening (18-CR)

#### Two Tier:

20-1/4" Min Inside Cabinet Depth  
 22" Min Cabinet Height Opening

#### Three Tier:

20-1/4" Min Inside Cabinet Depth  
 25" Min Cabinet Height Opening



Two Tier



Three Tier

### **Two-Tier w/ Soft Close**

5PSP15SC-CR

5PSP18SC-CR

### Dimensions

26-1/4" W x 20-1/4" D x 21" H

32-1/4" W x 20-1/4" D x 21" H

### Min Opening

15" W x 22" H

18" W x 22" H

### List/ea

\$ 738.11

909.89

### **Two-Tier w/ Std. Close**

5PSP15-CR

5PSP18-CR

26-1/4" W x 20" D x 20-3/4" H

32-1/4" W x 20" D x 20-3/4" H

15" W x 22" H

18" W x 22" H

657.62

729.78

### **Three-Tier w/ Soft Close**

5PSP3-15SC-CR

5PSP3-18SC-CR

26-1/4" W x 20-1/4" D x 24" H

32-1/4" W x 20-1/4" D x 24" H

15" W x 25" H

18" W x 25" H

889.91

980.22



## PANTRY STORAGE

### ABOVE APPLIANCE PULL-OUT

5708 Series, Non-handed

5708-15CR



- Fits 24" deep wall cabinetry
- Chrome round wire construction
- Reversible design: attached to either side of cabinet
- Adjustable door mount brackets for perfect fit

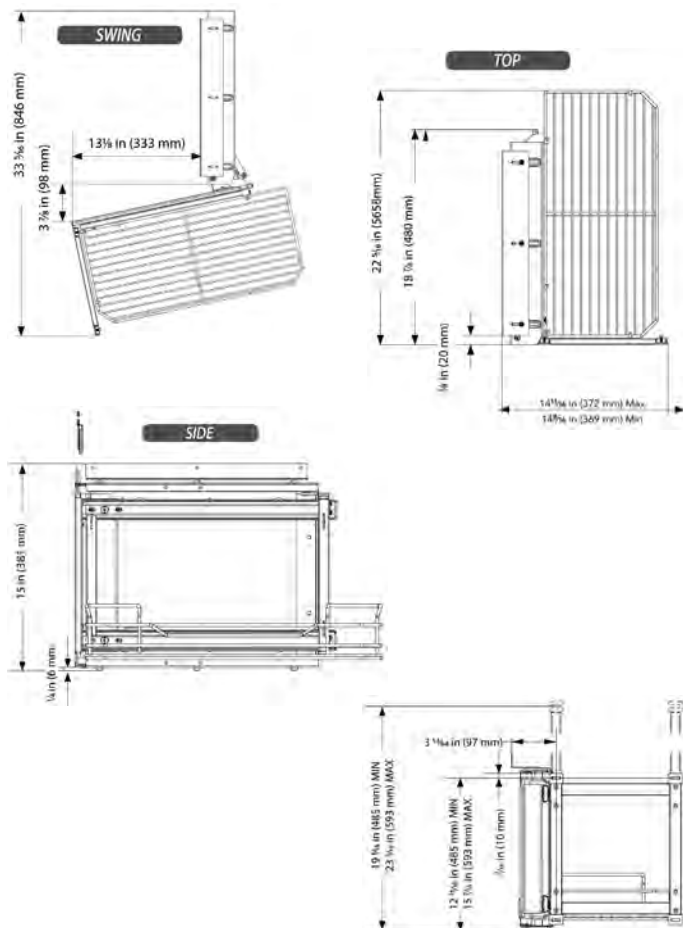

Dims: 13" W x 19" D x 15" H

Code	Min Cab Opening	List/ea
5708-15CR	14-3/4" W x 15-1/2" H	\$ 519.76

### WOOD SWING OUT PANTRY For Tall Pantry Cabinets

Top Rails  
 add 1-1/4"

**MIN. HEIGHT**  
 without top rails

4WDP18-45  
**45-3/4"**

4WDP18-51  
 4WSP18-51  
 4WP18-51-KIT  
**52"**

4WDP18-57  
 4WSP18-57  
 4WP18-57-KIT  
**57-3/4"**



Swing Out Single  
 component  
**4WSP18-51**  
**4WSP18-57**



Pantry Door Single  
 component  
**4WDP18-45**  
**4WDP18-51**  
**4WDP18-57**

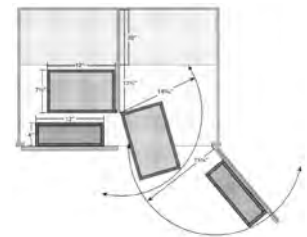

Door Mount  
 Brackets allow up  
 to 5" of adjustment!

These pantry storage units for 36" cabinets feature industrial piano hinges and adjustable inside shelves with chrome rails. Chrome bars can be added to the top of the units. Solid 1/2" maple has a UV-cured, clear finish. Complete kit includes (2) swing-out units and (2) door storage units with adj. mounting brackets.

Code	Description	List
4WDP18-45	45" Pantry Door Unit (w/hdwr) Single 12" W x 4" D x 45" H	\$ 214.50
4WP18-51-KIT	51" Swing Out Pantry Kit - Includes (2) 4WSP18-51 and (2) 4WDP18-51	1058.67
4WSP18-57*	57" Swing Out Pantry (w/hdwr) Single 12" W x 7-1/2" D x 57" H	323.97
4WDP18-57*	57" Pantry Door Unit (w/hdwr) Single 12" W x 4" D x 57" H	239.74
4WP18-57-KIT*	57" Swing Out Pantry Kit - Includes (2) 4WDP18-57 and (2) 4WSP18-57	1079.08

\*Top Rail NOT included with these models



## PANTRY STORAGE



### 448TP PULL-OUT WOOD PANTRY

Rev-A-Shelf



- Pre-finished Maple
- Adjustable shelves
- Soft-Close, 450 lb. slide
- Includes slide and all mounting hardware: Ready to assemble
- Door mount brackets with micro-adjustment for door alignment and tilt
- Rub bushing included for 1-1/2", 1-5/8", 1-3/4" face frames
- Fully accessible top shelf
- Available in 4 widths and 3 heights

Rear wall can be adjusted to accommodate a large range of cabinet heights.



View from rear of cabinet

#### Product Dimensions

Code	Width	Depth	Height Min	Height Max
448TP43-5	5"	22"	43-3/8"	50-3/8"
448TP51-5	5"	22"	50-7/8"	57-7/8"
448TP58-5	5"	22"	58-3/8"	65-3/8"
448TP43-8	8"	22"	43-1/4"	50-1/4"
448TP51-8	8"	22"	50-3/4"	57-3/4"
448TP58-8	8"	22"	58-1/4"	65-1/4"
448TP43-11	11"	22"	43-1/4"	50-1/4"
448TP51-11	11"	22"	50-3/4"	57-3/4"
448TP58-11	11"	22"	58-1/4"	65-1/4"
448TP43-14	14"	22"	43-1/4"	50-1/4"
448TP51-14	14"	22"	50-3/4"	57-3/4"
448TP58-14	14"	22"	58-1/4"	65-1/4"

#### Cabinet Dimensions

Width	Height	List
5-1/2" to 6"	43-1/2" to 51"	\$ 791.43
5-1/2" to 6"	51" to 58-1/2"	833.74
5-1/2" to 6"	58-1/2" to 66"	859.64
8-1/2" to 9"	43-1/2" to 51"	887.74
8-1/2" to 9"	51" to 58-1/2"	880.29
8-1/2" to 9"	58-1/2" to 66"	929.17
11-1/2" to 12"	43-1/2" to 51"	928.51
11-1/2" to 12"	51" to 58-1/2"	988.19
11-1/2" to 12"	58-1/2" to 66"	1039.23
14-1/2" to 15"	43-1/2" to 51"	1000.65
14-1/2" to 15"	51" to 58-1/2"	1081.77
14-1/2" to 15"	58-1/2" to 66"	1156.15



## PANTRY STORAGE

### **5700 SERIES WIRE PANTRY PULLOUT with SOFT CLOSE**

All Special Order



- Full extension, 250 lb. rated slides with soft-close.
- For 24" deep cabinetry
- Adjustable door mount brackets
- Top and bottom slide covers for a finished look
- Kit packaged with frame, baskets and hardware

All baskets are 17-1/4" deep and 3" in height and are adjustable. Frame depth is 21-11/16".

<u>Code</u>	<u>No. of Baskets</u>	<u>Basket Width</u>	<u>Product Width</u>	<u>MCO</u>	<u>List/ea</u>
<b>Height: 43-13/32" to 50-3/4" (3 door mount brackets)</b>					
5743-14-CR-1	4	14"	14-1/4"	14-7/8"	\$ 1065
<b>Height: 50-3/4" to 58-9/32" (3 door mount brackets)</b>					
5750-10-CR-1	4	10"	11-9/16"	12"	1005
5750-14-CR-1	4	14"	14-1/4"	14-1/2"	1065
<b>Height: 58-1/4" to 65-3/4" (4 door mount brackets)</b>					
5758-08-CR-1	5	8"	8-1/4 - 9-5/8"	10"	1139
5758-10-CR-1	5	10"	10-1/4 - 11-9/16"	12"	1127
5758-14-CR-1	5	14"	14-1/4 - 17-19/32"	14-12"	1225
5758-20-CR-1	5	19"	20-11/16 - 21-11/16"	21"	1298
<b>Height: 73-5/8" to 80-3/4" (4 door mount brackets)</b>					
5773-04-CR-1	6	4-1/8"	4-1/2"	4-1/2"	992
5773-08-CR-1	6	8"	8-1/4"	8-1/2"	1164
5773-14-CR-1	6	14"	14-1/4"	14-1/2"	1311



Adjustable Baskets



Adjustable Door Mount Bracket



Adjustable Frame Height

## PANTRY STORAGE



**12 Minute Install    Soft-Close Pantry**

**Door adjusts:**  
 Height, Side, Door Warp & Tilt

**Full Depth: 22-3/4"    High Capacity: 23% more storage**



Chrome Plated Baskets



Maple Melamine base, Silver powder coated Baskets

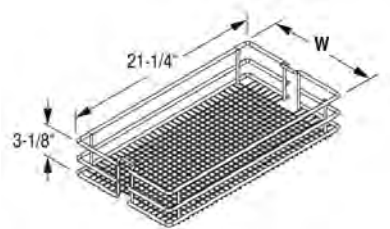

Chrome or Maple

- 12 Minute Install
- Door adjusts for:  
 Height, Side, Door Warp & Tilt
- Baskets Adjust in 2-1/2" steps
- Synchro-action : 265 lbs.
- Five widths : 9" - 20"
- Any height 26" - 84"

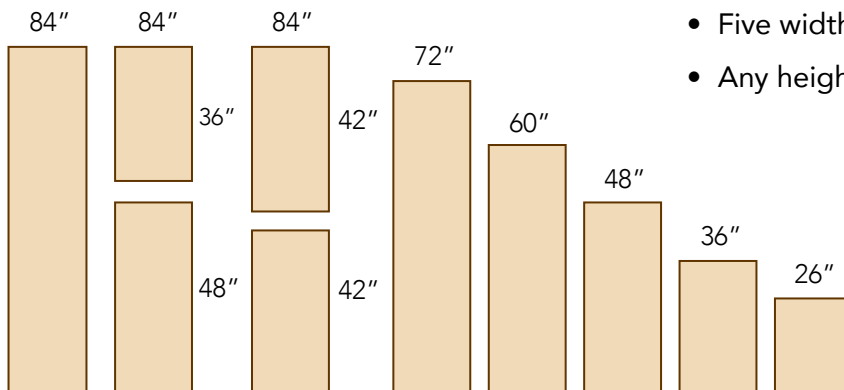

**Many Solutions Possible:** every inch from 26" to 84" high. Five widths: 9" - 20".



# PANTRY STORAGE

Depth: 22-3/4"

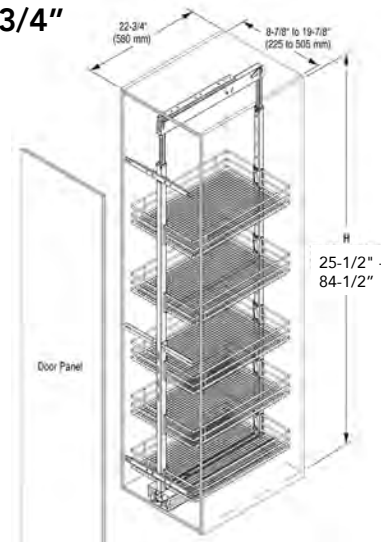

### Chef Pantry

Complete sets include pantry pull-out frame, top and bottom slides, baskets and door adapters.

Cabinet Dimensions:

Specify **Width** and **Basket type** when ordering:  
'C' for Chrome baskets or 'M' for Maple baskets  
(Example: 9076-11C)

Complete Sets	# of Baskets	Min Width	Frame Ht	Depth	List Chrome	List Maple
9037-8 'C' or 'M'	2	8-7/8"	25-1/2" - 37-1/2"	22-3/4"	\$ 764.75	\$ 876.75
9037-11 'C' or 'M'	2	11-5/8"	25-1/2" - 37-1/2"	22-3/4"	771.75	883.75
9037-14 'C' or 'M'	2	14-3/8"	25-1/2" - 37-1/2"	22-3/4"	784.00	887.25
9037-17 'C' or 'M'	2	17-1/8"	25-1/2" - 37-1/2"	22-3/4"	794.50	920.50
9037-19 'C' or 'M'	2	19-7/8"	25-1/2" - 37-1/2"	22-3/4"	859.25	990.50
9047-8 'C' or 'M'	4	8-7/8"	37-1/2" - 47-1/4"	22-3/4"	876.75	1156.75
9047-11 'C' or 'M'	4	11-5/8"	37-1/2" - 47-1/4"	22-3/4"	910.00	1167.25
9047-14 'C' or 'M'	4	14-3/8"	37-1/2" - 47-1/4"	22-3/4"	955.50	1174.25
9047-17 'C' or 'M'	4	17-1/8"	37-1/2" - 47-1/4"	22-3/4"	976.50	1239.00
9047-19 'C' or 'M'	4	19-7/8"	37-1/2" - 47-1/4"	22-3/4"	1057.00	1321.25
9057-8 'C' or 'M'	4	8-7/8"	47-1/4" - 57"	22-3/4"	866.25	1139.25
9057-11 'C' or 'M'	4	11-5/8"	47-1/4" - 57"	22-3/4"	892.50	1149.75
9057-14 'C' or 'M'	4	14-3/8"	47-1/4" - 57"	22-3/4"	938.00	1156.75
9057-17 'C' or 'M'	4	17-1/8"	47-1/4" - 57"	22-3/4"	960.75	1223.25
9057-19 'C' or 'M'	4	19-7/8"	47-1/4" - 57"	22-3/4"	1041.25	1303.75
9067-8 'C' or 'M'	4	8-7/8"	57" - 67"	22-3/4"	880.25	1160.25
9067-11 'C' or 'M'	4	11-5/8"	57" - 67"	22-3/4"	917.00	1174.25
9067-14 'C' or 'M'	4	14-3/8"	57" - 67"	22-3/4"	957.25	1176.00
9067-17 'C' or 'M'	4	17-1/8"	57" - 67"	22-3/4"	990.50	1253.00
9067-19 'C' or 'M'	4	19-7/8"	57" - 67"	22-3/4"	1072.75	1335.25
9076-8 'C' or 'M'	6	8-7/8"	67" - 76-3/4"	22-3/4"	1055.25	1475.25
9076-11 'C' or 'M'	6	11-5/8"	67" - 76-3/4"	22-3/4"	1107.75	1494.50
9076-14 'C' or 'M'	6	14-3/8"	67" - 76-3/4"	22-3/4"	1170.75	1498.00
9076-17 'C' or 'M'	6	17-1/8"	67" - 76-3/4"	22-3/4"	1214.50	1606.50
9076-19 'C' or 'M'	6	19-7/8"	67" - 76-3/4"	22-3/4"	1305.50	1701.00
9091-8 'C' or 'M'	6	8-7/8"	74-3/4" - 84-1/2"	22-3/4"	1060.50	1480.50
9091-11 'C' or 'M'	6	11-5/8"	74-3/4" - 84-1/2"	22-3/4"	1113.00	1499.75
9091-14 'C' or 'M'	6	14-3/8"	74-3/4" - 84-1/2"	22-3/4"	1176.00	1505.00
9091-17 'C' or 'M'	6	17-1/8"	74-3/4" - 84-1/2"	22-3/4"	1219.75	1611.75
9091-19 'C' or 'M'	6	19-7/8"	74-3/4" - 84-1/2"	22-3/4"	1310.75	1706.25



## PANTRY STORAGE



### CHEF PANTRY Features

#### Face Frame Cabinet with Maple Shelves



- Full depth - 22-3/4" for increased storage in American cabinets; up to 25% more
- Syncro-action heavy duty slides for a smooth and quiet open / close
- 265 lb Load Capacity
- Soft Open and Soft Close with Power-Assist closing
- High capacity baskets adjust in 2-1/2" steps
- Designed with 5 Adjustable frames to allow any height from 26" to 84"
- 5 Basket widths from 9" to 20"
- Door front adjustments for: Height, Side, Tilt, and Door Warp
- Installs easily in Traditional Face Frame or in Frameless Euro cabinets



Maple finish shelves give a warm wood look.



Saphir chrome shelf has a strong double wire bottom.

#### Frameless Cabinet with Saphir Chrome Shelves



See two previous pages for more details, product codes and pricing.



## CABINET STORAGE

### TALL CABINET FILLERS

432 TF Series



Each section of filler operate independently



432 Tall Filler Organizers

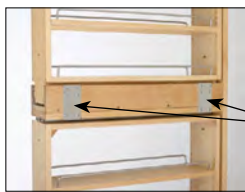

Included Mending Plates securely fastens the frames of 2 Fillers.

Create a pantry behind decorative panels with these tall fillers. Available for 6" applications, the 432TF Series comes in 39" and 45" heights and can be used alone or in conjunction with others to meet your 84", 90", or 96" height requirements.

Each unit features adjustable shelves (5 for the 39", and 6 for the 45") with chrome rails, 150 lb. full extension ball bearing slides, mounting brackets and three-slide design that provides for the most stable function on the market. Made from maple with a UV clear coat finish.

Available in 39" and 45" Heights.

Code	Dimensions	List
432-TF39-6C	6" W x 23" D x 38-1/2" H	\$ 441.67
432-TF45-6C	6" W x 23" D x 44-1/2" H	475.60

### VANITY FILLER PULL-OUT - Soft Close

432 VF Series



432VF

Available for Base Height and Vanity Height Applications.

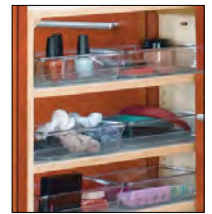

Acrylic Bins included



Installation is easy! Simply attach the organizer to adjacent cabinets and add a filler front and decorative onlay for a completely functional storage pull-out.

Vanity filler storage pull-out to utilize wasted space behind decorative fillers. The adjustable wood shelves feature clear polycarbonate rails and non-skid vinyl shelf liners. Four clear acrylic storage trays are also included to keep smaller items organized. Available in 3" and 6" widths. Full-extension, 110 lb. rated slides with Soft Close.

#### Vanity Height - with 4 acrylic bins

Code	Dimensions	List
432-VF26SC-3	3" W x 19" D x 26" H	\$ 372.53
432-VF26SC-6	6" W x 19" D x 26" H	448.73



## CABINET STORAGE



### BASE CABINET FILLERS

432 BF Series



Attach filler to one side of the cabinet and add a decorative onlay for a completely functional storage pull-out.

Add storage space behind decorative panels with base or wall filler cabinets. Transforms decorative fillers into functional storage pull-outs. Features adjustable shelves with chrome rails and full extension ball-bearing slides. Wood is solid maple/birch, UV cured with clear finish.

Available in three different slides:

432-BF: Full Extension Ball Bearing Slides

432-BFBBSC: Full Extension Soft Close Ball Bearing Slides

432-BFSC: Full Extension Blumotion Soft Close Slides

On the 432-BFSC, middle shelf is solid for extra support. All base organizers come fully assembled.

#### 432-BF Full Extension Ball Bearing Slides

Code	Dimensions	List/ea
432-BF-3C	3" W x 23" D x 30" H	\$ 246.37
432-BF-6C	6" W x 23" D x 30" H	314.33
432-BF-9C	9" W x 23" D x 30" H	458.52

#### 432-BFBBSC with Soft Close

432-BFBBSC-3C	3" W x 23" D x 30" H	\$ 261.65
432-BFBBSC-6C	6" W x 23" D x 30" H	365.07

#### 432-BFSC with Blumotion Soft Close

432-BFSC-3C	3" W x 23" D x 30" H	\$ 354.18
432-BFSC-6C	6" W x 23" D x 30" H	424.92

### WALL CABINET FILLERS

432 WF Series

Four Heights Available



Wall Filler Pull-Out Cabinets create functional storage space behind decorative panels. Adjustable shelves with chrome rails and full-extension ball-bearing slides. Solid maple/birch, UV cured with clear finish. Comes fully assembled.

Code	Dimensions	List/ea
432-WF-3C	3" W x 11-1/8" D x 30" H	\$ 177.22
432-WF-6C	6" W x 11-1/8" D x 30" H	225.90
432-WF36-3C	3" W x 11-1/8" D x 36" H	204.37
432-WF36-6C	6" W x 11-1/8" D x 36" H	237.19
432-WF39-3C	3" W x 11-1/8" D x 39" H	215.35
432-WF39-6C	6" W x 11-1/8" D x 39" H	251.15
432-WF42-3C	3" W x 11-1/8" D x 42" H	224.66
432-WF42-6C	6" W x 11-1/8" D x 42" H	263.78

### SWIVEL SHELF PULL-OUT

Features two swiveling shelves that allow the user to easily see and access items, and then return to center with the built-in centering system.



Designed for 9" and 12" full height base cabinets. Constructed from natural maple with a semi-gloss finish. Full-ext, soft-close concealed slides.

Dims:

448SW-BCSC-5C:	6" W x 22-25/32" D x 25-1/2" H
448SW-BCSC-8C:	8-3/4" W x 22-25/32" D x 25-1/2" H

Code	MCO FF	MCO FL	List/ea
448SW-BCSC-5C	5-3/4"	6"	\$ 476.94
448SW-BCSC-8C	8-3/4"	9"	594.47



## CABINET STORAGE

### BASE ORGANIZER PULL-OUTS

Available in standard and Soft Close versions



438-BC-3C



- 3" Width unit designed for full height 6" base cabinets
- Trimmable to 26-3/8" height for custom cabinets
- Glides on top and bottom 100 lb. full extension slides for complete stability, soft close version available
- Shelves are adjustable
- Fully assembled maple construction with chrome accents
- Can also be installed in frameless cabinet

#### Installation methods

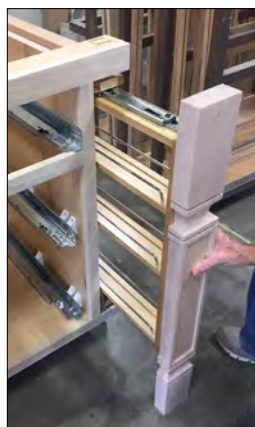

#### Compare with 432 Series:

	432 Base	438 Base
Height	30"	27-5/16" trimmable to 26-3/8"
Shelves	4	3
Slides	3 (top, bottom 2 sides)	2 (top and bottom)

Product Dimensions:  
3" W x 23" D x 27-5/16" H

Min Cabinet  
Opening: 3"

Code	Description	List/ea
438-BC-3C	3" Base Organizer	\$ 220.67
438-BCSC-3C	Soft Close 3" Base Organizer	391.22

### WALL FILLER PULL-OUT SHELF

448 Series



Shelf Pull-Out with chrome rails designed for wall 9" and 12" cabinets. Features full-extension, ball-bearing slides (standard and Soft Close available) and adjustable door mount brackets providing up to 5" of flexibility for trouble-free installation on any door style. Includes up to three adjustable shelves with chrome wire accents. Wood is solid maple/birch, UV-cured with clear finish.



448-BBSCWC-5C



448-BBSCWC-8C

All units 10-3/4" Depth and 26-3/16 - 27-7/8" Height.

Code	Width	MCO	List
448WC-05C	5"	5-1/2"	\$ 180.04
448WC-08C	8"	8-1/2"	209.55
<b>Soft Close</b>			
448-BBSCWC-5C	5"	5-1/2"	200.75
448-BBSCWC-8C	8"	8-1/2"	234.94

MCO = Minimum Cabinet Opening

## CABINET STORAGE



### REV-A-SHELF PULL-OUT BASE ORGANIZER

448 Series

- Micro door adjustment
- Adjustable shelves
- Soft Closing available

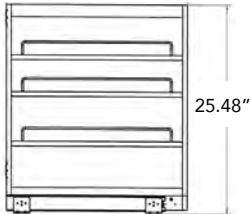

Pull-out Base Organizer contains: 3-tier pull-out, chrome side rails and full extension "tri-slides" for complete stability and easy installation. Also available in Soft-Close w/ Ball Bearing and Soft-Close w/ Blum Tandem slides. **All units 25-1/2" Height.**

MCO

Code	Width x Depth	FF	FL	List
448-BC-5C	5" x 22.5"	5.5"	5.5"	\$ 246.32
448-BC19-5C	5" x 19"	5.5"	5.5"	276.29
448-BC-6C	6.5" x 22.5"	7"	7"	280.25
448-BC-8C	8" x 22.5"	8.5"	8.5"	310.37
448-BC19-8C	8" x 19"	8.5"	8.5"	383.97
448-BC-11C	11" x 22.5"	11.5"	11.5"	417.13
448-BC-14C	14" x 22.5"	14.5"	14.5"	501.07

#### Soft Close w/ Ball Bearing

448-BCBBSC-5C	5" x 21-3/4"	5.5"	5.5"	\$ 315.85
448-BCBBSC-8C	8" x 21-3/4"	8.5"	8.5"	347.32

MCO

Code	Width x Depth	FF	FL	List
448-BCSC-5C	6" x 21-5/8"	5.5"	6"	350.10
448-BC19SC-5C	6" x 19-9/16"	5.5"	6"	355.20
448-BCSC-6C	7-1/4" x 21-5/8"	7.5"	7.5"	384.72
448-BCSC-8C	8-3/4" x 21-5/8"	8.5"	9"	389.41
448-BC19SC-8C	8-3/4" x 19-9/16"	8.5"	9"	459.70
448-BCSC-9C	10-1/4" x 21-5/8"	10.5"	10.5"	452.89
448-BCSC-11C	11-3/4" x 21-5/8"	11.5"	12"	473.86
448-BCSC-14C	14-3/4" x 21-5/8"	14.5"	15"	584.64

MCO = Minimum Cabinet Opening  
 FF = Face Frame, FL = Frameless

### REV-A-SHELF PULL-OUT BASE ORGANIZER

448 Series - For 12" & 15" Drawer/Door base cabinets

- New reduced minimum height of 19-3/8" allows for drawer/door combo
- Includes Full Extension, Soft Close slides
- Door mount brackets provide 5" of adjustability
- Adjustable shelves with chrome rails
- Maple with UV clear coat finish



All units 21-5/8" Depth & 19-3/8" Height.

MCO

Code	Product Width	FF	FL	List
448-BDDSC-5C	5-29/32"	5.5"	6"	\$ 311.23
448-BDDSC-8C	8-3/4"	8.5"	9"	393.21
448-BDDSC-11C	11-3/4"	11.5"	12"	451.96

### SPICE RACK FOR 448 BASE ORGANIZERS

Use with 8" Width



Spice Rack Insert

448-BC-8C



Keep spices within reach with the 448 Spice Rack Insert. Features a unique angled design for easy spice access, drop-in installation, and a maple UV clear coat finish to match pullout.

448-SR8: 7" W x 21" D x 4-7/8" H  
 448-08SC-SRI-1: 7" W x 19-1/2" D x 4-7/8" H

Code	Use with	List
448-SR8	448-BC-8C	\$ 79.09
448-08SC-SRI-1	448-BCBBSC-8C & 448-BCSC-8C	85.82



## CABINET STORAGE

### BASE CABINET PULLOUT KNIFE/UTENSIL ORGANIZER

w/ Blumotion Soft-Close



448KB-BCSC-8C

Knife/Utensil  
 Organizer Pullout



448KB-BCSC-11C

- Features 2 universal knife inserts, stainless steel utensil bin(s) and adjustable shelf for lower storage
- Full-extension soft-close slides
- Includes door mount brackets and adj. rub bushings
- Adjustable rear wall for extra strength and stability
- Knife inserts feature movable flex rods that adjust to hold a multitude of knives
- (4) color-coded flexible, dishwasher safe cutting mats with food icons to prevent cross-contamination
- 5" and 8" base includes one 5-1/4" stainless steel bin, 11" base includes four stainless steel bins: two 5-1/4" and two 5"

All units 21-5/8" Depth and 25-1/2" Height.

Code	Width	MCO		List
		FF	FL	
448KB-BCSC-5C	5"	5.5"	6"	\$ 565.61
448KB-BCSC-8C	8-3/4"	8.5"	9"	654.63
448KB-BCSC-11C	11-3/4"	11.5"	12"	781.42

MCO = Minimum Cabinet Opening  
 FF = Face Frame, FL = Frameless

### UTENSIL BIN BASE ORGANIZER

w/ Blumotion Soft-Close



448UT-BCSC-8C



448UT-BCSC-5C



448UT-BM bins  
 (2 sizes) sold  
 separately

- Designed for full height 9" and 12" base cabinets
- Adjustable shelves/rear wall for strength and durability
- Comes with 3 stainless steel bins
- Full extension 135 lb. Soft Close slides

Dimensions	Width	Depth	Height
448UT-BCSC-5C	6"	21-5/8"	25-1/2"
448UT-BCSC-6C	7-1/8"	21-21/32"	25-1/2"
448UT-BCSC-8C	8-3/4"	21-5/8"	25-1/2"
448UT-BCSC-9C	10-1/8"	21-21/32"	25-1/2"

Min Cabinet Opening

Code	FF	FL	List/ea
448UT-BCSC-5C	5.5"	6"	\$ 442.24
448UT-BCSC-6C	7.5"	7.5"	427.28
448UT-BCSC-8C	8.5"	9"	500.59
448UT-BCSC-9C	10.5"	10.5"	489.20

#### Extra Bins

448UT-BM-125	4" dia, 1.25 qt	\$ 19.84
448UT-BM-200	5-1/8" dia, 2 qt.	26.85

## CABINET STORAGE



### 449 SERIES SOFT CLOSE BASE PULLOUTS

Side and Bottom Mount



449-BCSC Base Pullouts

### 449UT-BCSC Utensil Base Pullouts



- Foldable slide set for easy installation on Face Frames
- Mounts to cabinet door, floor & side for **extra stability**
- Includes door mount brackets with micro-adjustments
- Face frame units fit 1-3/4", 1-1/2" and 1-5/8" frames
- Maple construction with Chrome accents
- (2) adjustable shelves for the Base Organizer and (1) adjustable shelf for Utensil Organizer
- The 449UT Utensil Organizer features (3) 1-1/4" Qt removable stainless steel bins
- Full-extension, 110 lb. **Soft-Close** concealed slides



Face frame units include a foldable slide set for easy installation.

### All units 21-3/4" Depth

Face Frame	Width x Height	MCO	List/ea
449-BCSC-5C	6-1/4" x 25-19/32"	5-1/2"	\$ 420.97
449-BCSC-8C	9-1/4" x 25-19/32"	8-1/2"	492.12
449UT-BCSC-5C	6-1/4" x 25-19/32"	5-1/2"	445.35
449UT-BCSC-8C	9-1/4" x 25-19/32"	8-1/2"	530.00
<b>Full Access</b>			
449-BCSC-7C	7-1/2" x 25-1/4"	7-1/2"	407.59
449-BCSC-10C	10-1/2" x 25-1/4"	10-1/2"	495.62
449UT-BCSC-7C	7-1/2" x 25-1/4"	7-1/2"	437.80
449UT-BCSC-10C	10-1/2" x 25-1/4"	10-1/2"	517.42

MCO = Minimum Cabinet Opening

### TWO-TIER BASE ORGANIZER

548 Series

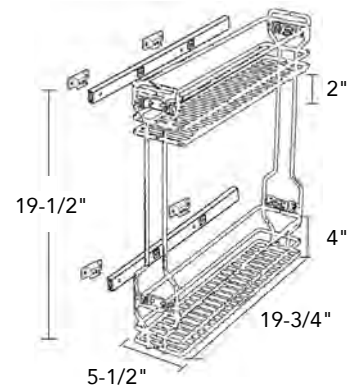

5-1/2" Chrome Base Organizer with ball-bearing reversible slides and 12-1/2" extension with door mounting capability. Side mount. Mounting screws and spacers (for face frame installation) are included. Overall: 5-1/2" W x 19-3/4" D x 19-1/2" H.

Code	Finish	MCO	List/ea
548-06CR	Chrome	6.75"	\$ 133.01

### SPARE UTENSIL BINS FOR 448UT



448UT-BM  
 bins (2 sizes)

- Stainless steel bins for 448UT base organizers
- 1.25 and 2 quart sizes

Code	Description	List/ea
448UT-BM-125	4" dia, 1.25 qt	\$ 19.84
448UT-BM-200	5-1/8" dia, 2 qt.	26.85



## CABINET STORAGE

### BASE CABINET SIDEKICK PULLOUT



Attaches to a 448-BCSC Base Pullout and Slides Independently!

448-BSKT-3C

- Natural maple construction with chrome wire accents
- (2) configurations available; Spices or Baking Trays/Foil
- Add 3" to the existing 448 footprint per sidekick
- Full-ext, ball-bearing slides
- Slides independently providing complete access to the attached 448



448-BSKS-3C

Dims:

3" Width x 20-3/4" Depth x 23-15/16" Height



Sidekick

448-BCSC

Combined unit

Sidekick attaches to a **448-BCSC (5C - 14C)** and adds 3" to the footprint per sidekick.

Code	Description	List/ea
448-BSKT-3C	Sidekick pullout for Baking Trays/ Foil	\$ 224.44
448-BSKS-3C	Sidekick pullout for Spices	224.44

\*Not compatible with 448SW, 448-BCBBSC, 448BC, 448-BDDSC or 448-BC19SC-5C reduced depth pullouts.

### TOWEL BAR BASE FILLER PULLOUT



A better way to store hand towels and cleaning supplies. Features natural maple construction, full-extension, ball-bearing slides with soft-close, two towel bars and a static shelf with chrome wire accents. Mounts between cabinets.

Code	Dimensions	List/ea
432TB-BFBBSC-3C	3" W x 23" D x 30" H	\$ 281.13
432TB-BFBBSC-6C	6" W x 23" D x 30" H	385.38

### PAPER TOWEL PULLOUT



448PTH-BCSC-8C



Clean-up your cleaning supplies with this 448PTH Series Base Organizer that lets you store and find everything in one easy to access pullout. Features two compartments and a paper towel holder. Natural maple construction with semi-gloss finish.

Dims:

21-11/16" Depth x 26-29/32" to 30-7/8" Height

Code	Width	MCO	List/ea
448PTH-BCSC-6C	6-7/8"	6-5/8" (FF) 7-1/8" (FL)	\$ 377.22
448PTH-BCSC-8C	8-3/4"	8-1/2" (FF) 9" (FL)	447.11

MCO = Minimum Cabinet Opening  
 FF = Face Frame, FL = Frameless

## CABINET STORAGE



### SUB SIDE PULL-OUT STORAGE

Soft Close

23" Depth



5" chrome baskets for min cab opening width of 6"



9" chrome basket for min cab opening width of 10-1/8"

- 3-D front adjustment
- Full-Extension, side mounted with soft-close/self close
- Non-handed
- Load capacity: 45 lbs.
- Door mount brackets included
- Chrome finish

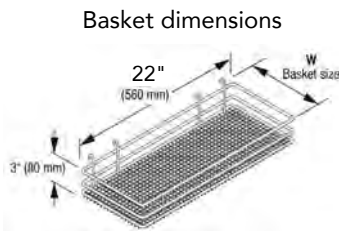

Basket dimensions

Two Basket widths available

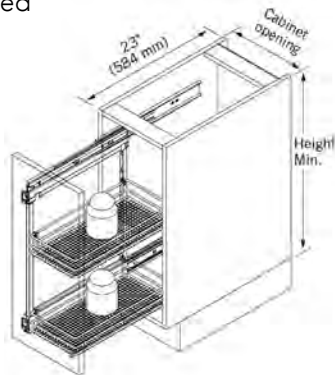

Cabinet dimensions allow 23" Depth

### SUB SLIM PULL OUT STORAGE

Soft Close



Baking Tray Holder  
 90004112



Towel Holder  
 90004111

Cabinet Dimensions

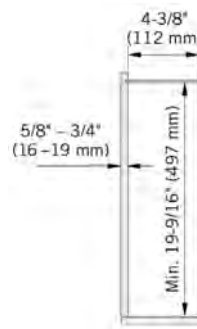

Product Dimensions

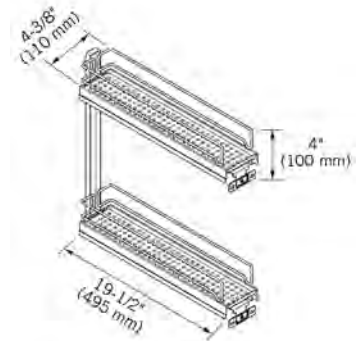

- Side Mount installation
- Min Opening width: 4-3/8" (112mm)
- Installation depth: min. 19-1/2" (495mm)
- Installation height: min. 20-15/16" (532mm)

- Easy, tool-free installation
- Simple 3D front adjustment
- Integral soft closing and self closing on both runners
- Load cap: 13 lbs. max per shelf element

### Order Frame and Baskets Separately

Frame	Frame Height	For Basket Qty	List/ea
90002999	19-11/16"	2	\$ 112.00
90003259	26-1/2"	3	241.63

Code	Description	List/ea
90004111*	Sub Slim, w/ Chrome Towel Holder	\$ 192.50
90004112*	Sub Slim, w/ Chrome Baking Tray Holder	192.50

\*disc when out

Baskets	Width	Min Cab Opening	Baskets per Set	List/st
90002572	5"	6"	3	\$ 208.27
90002576	9"	10-1/8"	3	252.75



## VANITY STORAGE

### GROOMING ORGANIZER

445 Series



Adjustable Door  
 Mount Brackets

445-VCG  
 Available  
 20-1/4" or 25-1/2" Ht.

- Now featuring full-extension Soft-Close slides
- Designed for Full Height Vanity and Base height 12" cabinet applications
- 19" Depth
- Adjustable shelves with non-skid vinyl liners and clear polycarbonate rails
- Includes two stainless steel bins for storing curling irons and hair dryers
- Adjustable door mount brackets

Contains (1) completely assembled organizer with 100 lb. weight rated, full extension slides and adjustable shelves.



Includes Stainless Steel Bins

Dimensions:

445-VCG20: 8-7/16" W x 19-9/16" D x 20-3/8" H  
 445-VCG25: 8-7/16" W x 19-9/16" D x 25-9/16" H

Code	Description	MCO		List/ea
		FF	FL	
445-VCG20-8	8" Vanity Ht. Organizer	9"	8.5"	\$ 343.94
445-VCG20SC-8	8" Vanity Ht. <b>Soft-Close</b> Organizer	9"	9"	418.73
445-VCG25-8	8" Base Ht. Organizer	9"	8.5"	401.95
445-VCG25SC-8	8" Base Ht. <b>Soft-Close</b> Organizer	9"	9"	476.48

### VANITY BASE ORGANIZER

448 VC Series



Adjustable Door  
 Mount Brackets

448-VC  
 Available  
 20-1/4" or 25-1/2" Ht.

- Now featuring full-extension Soft-Close slides
- Designed for Full Height Vanity and Base height 12" cabinet applications
- Adjustable shelves with non-skid vinyl liners and clear polycarbonate rails
- Includes polycarbonate bins and a 3rd shelf for more storage options
- Adjustable door mount brackets

Contains (1) completely assembled organizer with 100 lb. weight rated, full extension slides and adjustable shelves with polycarbonate bins.

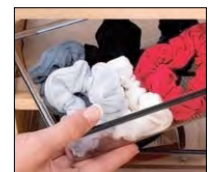

Includes  
 Polycarbonate Bins

Dimensions:

448-VC20: 8-7/16" W x 19-9/16" D x 20-3/8" H  
 448-VC25: 8-7/16" W x 19" D x 25-9/16" H

Code	Description	MCO		List/ea
		FF	FL	
448-VC20SC-8	8" Vanity <b>Soft-Close</b> Base Organizer	8.5"	9"	\$ 543.51
448-VC25SC-8	8" Base Ht. <b>Soft-Close</b> Grooming Organizer	8.5"	9"	631.28

MCO = Minimum Cabinet Opening  
 FF = Face Frame, FL = Frameless





# VANITY OUTLETS/STORAGE



## VANITY OUTLET GROOMING ORGANIZER

445VB Series



445 VB Series Grooming Organizer is now available with an integrated electrical outlet with two 120V plugs UL recognized to UL962/CSA-C22.2 No.0-10. It has a cord guide and a drawer stop that prevents items from being stored "ON" inside the cabinet.



Features two shelves with non-skid vinyl lining and two removable stainless steel bins. Glides on bottom and side mount soft-close slides that maximize stability and foldable slide set allows for easy installation.

Tamper resistant outlets

(2) removable stainless steel bins



Dimensions:

9-5/16" W x 19-3/4" D x 26-1/8" H



Code	Description	MCO		List/ea
		FF	FL	
445-VBOSC-8C	Grooming Organizer	8.5"	9.5"	\$ 804.56

## VANITY OUTLET DRAWER

4VOD Series

For Face Frame



- Designed for 18" base cabinet drawers
- (2) compartments, (2) stainless steel bins
- Full extension, 100 lbs, Soft-Close slides
- Includes mounting brackets for drawer front (drawer front not included)

Make the mess of a cluttered vanity a thing of the past with this vanity outlet drawer. Store hair dryers and curling irons in one easy-to-access location and additional compartments are perfect for organizing beauty products. With the integrated outlet you always have a free receptacle to plug items in. For Face Frame.

Dimensions:

15" W x 20-1/2" D x 8-15/16" H



Code	Description	MCO	List/ea
4VOD-18SC-1	Vanity Outlet Drawer for Face Frame	15"	\$ 563.97

Check out our other In-Drawer outlets pages 1662-1665.

MCO = Minimum Cabinet Opening  
FF = Face Frame, FL = Frameless

## ELECTRIC ASSIST

### GRASS SENSOMATIC ELECTRO-MECHANICAL OPENING KIT

Combine handle-free opening with the ever popular Soft-closing action. Just tap anywhere on the drawer front and the drawer opens automatically. The Sensomatic is an electro-mechanical opening system that works with the Dynapro slide system. One drive unit for cabinet widths up to 47-1/4" (1200mm). Ideal for waste bins and handle-free cabinet styles. Three settings for opening force.

#### Waste Bin Cabinet with bottom panel frame mounting

Sensomatic Kit  
 Set Includes:

- 1- Opening Unit ①
- 1- Base frame ①
- 1- Power supply unit ⑤
- 1- Power cord ⑦
- 4- Front bumpers ⑧

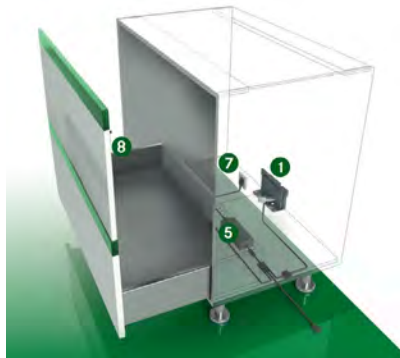

- Can be used with:  
 Rev-A-Shelf 5349 Series  
 Waste Bins, King Slide, Grass DWD-XP and  
 Nova Pro, and Blum Tandem.

Code	List/ea
F12-697	\$ 647.08



## WASTE CONTAINERS

### ELECTRIC ASSIST WASTE CONTAINERS 4WCSD Series

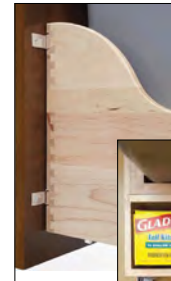

Create a Recycling Center!

Lid not included, but can be purchased separately. Can only be used on front bin.

(see page 1641 for lids)

The Rev-A-Shelf electric assist waste containers is available as a complete kit with a dovetail maple drawer box, adjustable door mounting brackets, durable polymer waste containers, plus Blum's Tandem heavy duty full extension concealed runners with Blumotion soft close and Servo-Drive touch-to-open.

It allows the waste container to open automatically with just a touch on the front of the door or with a light pull of the handle. Perfect for when your hands are full and you can't access your pull-out waste container. Silver polymer containers. Lid not included.

	Dimensions	Min Opening
4WCSD-1835DM-2	15"W x 22-1/2"D x 19-1/2"H	15"W
4WCSD-2150DM-2	18"W x 22-1/2"D x 24-1/4"H	18"W

Code	Description	List
4WCSD-1835DM-2	Double 35 Quart Electric Assist Waste containers	\$ 1114.63
4WCSD-2150DM-2	Double 50 Quart Electric Assist Waste containers	1188.86



# WASTE CONTAINERS

## WASTE / RECYCLE PULL-OUTS



- Easy to Install
- Bottom Mount, Soft Close
- Smooth Undermount Slides
- Adjustable door mount brackets improve stability: 15" vertical centers
- Bins equipped with handles to lift cans up



All units - Depth: 19-5/8", Height: 19-1/2" except QPAM15-2-50CR - 22" Depth and 24-1/16" Height\*

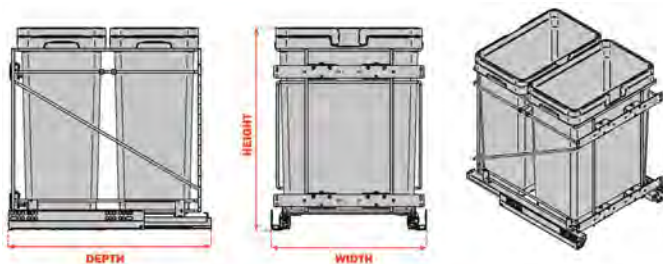

Lids available separately for 32 Qt, 35 Qt and 50 Qt bins.

Code	Description	List
QPAM12-1C	Single 35 Qt, 12" W	\$ 199.72
QPAM15-2C	Double 32 Qt, 15" W	280.93
QPAM18-2C	Double 32 Qt, 18" W	356.94
QPAM21-2C	Double 35 Qt, 21" W	370.88
QPAM15-2-50CR*	Double 50 Qt, 15" W	410.34
QPAM-32-LID	Lid for 32 Qt bin	25.65
QPAM-35-LID	Lid for 35 Qt bin	23.37
QPAM-50-LID	Lid for 50 Qt bin	23.30
QPAM15-TMP	Template for QPAM15	10.00

## DOOR MOUNT WASTE CONTAINERS

5149 Series / With Soft Close Slides



5149-18DM-217

Featuring single and double silver waste containers. Anodized aluminum frame with Rev-A-Motion Soft-Open/Soft-Close slides.



5149-15DM-117



- Aluminum Frame with mitered corners
- Versatile base works with 35 Qt and 50 Qt containers for easy upgrade to full height cabinet applications
- Adjustable door mount brackets with up to 5" of flexibility to fit any door style
- Built-in storage on all single units (except 18" slide units)
- Durable and easy to clean polymer base
- 150 lb. over-travel slides for full accessibility
- Available in 27, 35 and 50 Qt silver polymer containers
- Fully assembled

Min Width Opening

Code	Dimensions	Frameless	Face
5149-15DM-117	12-1/8"W x 22"D x 19-1/2"H	12-1/4"	11-1/2"
5149-15DM18-117	12-1/8"W x 18"D x 19-1/2"H	12-1/4"	11-1/2"
5149-1550DM-117	12-1/8"W x 22"D x 23-1/2"H	12-1/4"	11-1/2"
5149-1527DM-217	12-1/8"W x 22"D x 19-1/2"H	12-1/4"	11-1/2"
5149-18DM-217	14-3/16"W x 22"D x 19-1/2"H	14-1/2"	14-1/2"
5149-2150DM-217	15-5/8"W x 22"D x 23-1/2"H	15-3/4"	15-3/4"

Code	Description	List/ea
5149-15DM-117	Single 35 Qt Silver Bin	\$ 386.06
5149-15DM18-117	Single 35 Qt Silver Bin w/ 18" Slides	389.77
5149-1550DM-117	Single 50 Qt Silver Bin	387.65
5149-1527DM-217	Double 27 Qt Silver Bins	390.69
5149-18DM-217	Double 35 Qt Silver Bins	366.71
5149-2150DM-217	Double 50 Qt Silver Bins	381.44



## WASTE CONTAINERS

### PREMIER WASTE PULL OUTS

5349 Series / Soft Close

Rev-A-Shelf's Premier Pull Outs feature bottom mount, full extension, heavy-duty soft-close brushed aluminum slides, heavy duty wire frame for supporting the containers and a fully adjustable door mounting system. Single waste container set features a built-in storage area for bags. Load Cap: 85 lbs.



#### Single Pull-Out Waste Containers / White & Silver Polymer

Code	Description	Dimensions	MCO	List
5349-15DM-1	(1) 35 Qt. White Bin	10-3/4"W x 21-15/16"D x 19-1/4"H	11"	\$ 362.85
5349-15DM18-1	(1) 35 Qt. White Bin	10-13/16"W x 18"D x 19-5/16"H	11"	373.92
5349-15DM-117	(1) 35 Qt. Silver Bin	10-3/4"W x 21-15/16"D x 19-1/4"H	11"	427.89
5349-15DM18-117	(1) 35 Qt. Silver Bin	10-13/16"W x 18"D x 19-5/16"H	11"	427.03
5349-1550DM-1	(1) 50 Qt. White Bin	10-3/4"W x 21-15/16"D x 23-1/8"H	11"	383.88

#### Double Pull-Out Waste Containers / White & Silver Polymer



Code	Description	Dimensions	MCO	List
5349-1527DM-2	(2) 27 Qt. White Bin	11-11/16"W x 22-1/4"D x 18-15/16"H	12"	\$ 396.11
5349-1527DM-217	(2) 27 Qt. Silver Bin	11-11/16"W x 22-1/4"D x 18-15/16"H	12"	403.03
5349-18DM-2	(2) 35 Qt. White Bin	14-13/16"W x 21-7/8"D x 19-1/4"H	15"	391.97
5349-18DM-217	(2) 35 Qt. Silver Bin	14-13/16"W x 22-1/8"D x 19-1/4"H	15"	421.31
5349-2150DM-2	(2) 50 Qt. White Bin	14-13/16"W x 22-1/8"D x 22-15/16"H	15"	431.02
5349-2150DM-217	(2) 50 Qt. Silver Bin	14-13/16"W x 22-1/8"D x 22-15/16"H	15"	444.08

### DOOR MOUNT EXTENDER KIT

For 5349 Series

The Door Mount Extender Kit is designed for Rev-A-Shelf aluminum frame pull-outs.

Attaches to the existing door bracket for an extended mounting adjustability for any drawer front or cabinet door style where previously a sub-door might have been required. Kit can be used on the Rev-A-Shelf 5349, 5498, 5527 and 5590 Series.

Code	Description	List/ea
5345-DM-KIT-1	Door Mount Extender Kit	\$ 35.29

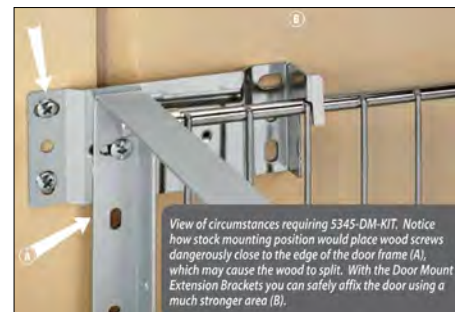

## WASTE CONTAINERS



### SOFT CLOSE WASTE CONTAINERS

4WCSC Series



Create a Recycling Center!

Lid not included, but can be purchased separately. Can only be used on front bin.

(see page 1641 for lids)

Bottom Mount waste containers feature Blum Tandem heavy duty, full-extension concealed Soft-Close slides. Dovetail maple drawer box. Comes with 35 or 50 Qt. containers. Door mount with adjustable brackets. Metallic silver waste bins.

	<u>Dimensions</u>	<u>MCO</u>
4WCSC-1535DM-1	12"W x 21-3/4"D x 19-1/2"H	12"
4WCSC-1550DM-1	12"W x 21-3/4"D x 23-3/8"H	12"
4WCSC-1835DM-2	15"W x 21-3/4"D x 20-3/8"H	15"
4WCSC-2135DM-2	18"W x 21-3/4"D x 20-3/8"H	18"
4WCSC-2150DM-2	18"W x 21-3/4"D x 24-1/4"H	18"

<u>Code</u>	<u>Description</u>	<u>List</u>
4WCSC-1535DM-1	Single 35 Quart Soft Close pull-out	\$ 435.57
4WCSC-1550DM-1	Single 50 Quart Soft Close pull-out	463.19
4WCSC-1835DM-2	Double 35 Quart Soft Close pull-out	481.76
4WCSC-2135DM-2	Double 35 Quart Soft Close pull-out	511.50
4WCSC-2150DM-2	Double 50 Quart Soft Close pull-out	548.48

### TIP-ON WASTE CONTAINER KIT

Push Open/Soft Close Kit for 4WCSC Series Waste Containers



No Door Hardware needed! The perfect mechanical solution for handle free waste container pull-outs is now available in a kit for all standard depth waste containers. Simply add mechanism to concealed slides to allow easy fingertip opening.

- For Push-Open and Soft Close
- Features easy fingertip opening
- Kits for all standard depth waste containers, food storage and LEGRABOX units
- Extensive trigger range is ensured at all times
- 4D adjustment ensures a precise gap layout
- The integrated depth adjustment can be made tool-free using the adjustment wheel
- With a front gap of just 2.5 mm



Dimensions:  
 3-1/2" W x 9" D x 1-3/4" H

<u>Code</u>	<u>Description</u>	<u>List/ea</u>
4WC-TOKIT-12	Tip-on Kit for 12" cabinet opening	\$ 73.20
4WC-TOKIT-15	Tip-On Kit for 15" cabinet opening	73.20
4WC-TOKIT-18	Tip-On Kit for 18" cabinet opening	73.20



## WASTE CONTAINERS

### 4WC SERIES WASTE CONTAINERS

Bottom Mount

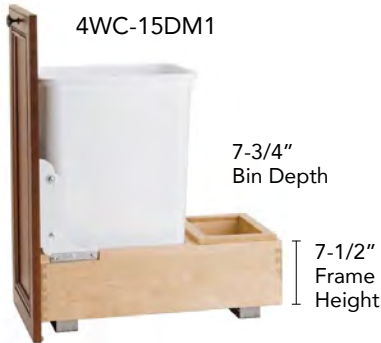

4WC-15DM1

7-3/4"  
Bin Depth

7-1/2"  
Frame Height



4WC-18DM2



4WC-24DM2-SC

- Solid Maple construction, dovetail frame with semi-gloss finish
- Pre-assembled door mount brackets included

- Single 35 Qt and Double 30 and 35 Qt containers, metallic silver or white
- 35 Qt containers: 150 lb. Full extension, ball bearing slides
- 30 Qt containers: 132 lb. Full extension w/ 3/4" overtravel, with Soft Close
- Rear storage with single 35 Qt and double 30 Qt units
- Mounts to cabinet door and floor

	Dimensions	MCO
4WC-15DM1	11-1/4"W x 21-3/4"D x 19-1/4"H	12"
4WC-18DM2	14-1/4"W x 21-3/4"D x 19-1/4"H	15"
4WC-24DM2-SC	20-15/16"W x 22-1/4"D x 19-5/8"H	21"

Code	Description	List/ea
4WC-15DM1	Single, Wht 35 Qt. Bin, w/ Door Mount	\$ 291.19
4WC-18DM2	Double, Wht 35 Qt. Bins, w/ Door Mount	287.97
4WC-24DM2-SC	Double, Silver 30 Qt. Bins, Soft Close	481.77

### REV-A-MOTION SOFT CLOSE WASTE CONTAINERS

4WCBM Series



4WCBM-18DM-2



4WCBM-2430DM-2

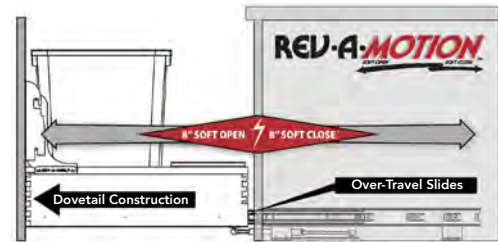

Bottom mount wood waste containers with Rev-A-Motion™ Soft Open/Soft Close slide system. Opens smoothly and shuts softly. Allows installation into 1-1/2", 1-5/8", and 1-3/4" face frame sizes, as well as frameless construction. Dovetail wood drawer with built-in door mount brackets and removable wood bin in rear for bag storage. Over-travel concealed 150 lb. slides. Metallic silver waste bins.

4WCBM-	Width x Depth x Height	MCO	
		FF	FL
-15DM-1	12" x 21-3/4" x 19-1/4"	11.5"	12.25"
-1550DM-1	12" x 21-3/4" x 23-3/16"	11.5"	12.25"
-18DM-2	14-1/4" x 21-3/4" x 19-1/4"	14.5"	14.5"
-2150DM-2	17-1/4" x 21-3/4" x 23-3/16"	17.5"	17.5"
-2430DM-2	20-1/4" x 21-3/4" x 19-1/4"	20.5"	20.5"

Code	Description	List/ea
4WCBM-15DM-1	Single 35 Qt Bin	\$ 388.25
4WCBM-1550DM-1	Single 50 Qt Bin	425.19
4WCBM-18DM-2*	Double 35 Qt Bins	470.55
4WCBM-2150DM-2*	Double 50 Qt Bins	515.60
4WCBM-2430DM-2	Double 30 Qt Bins	534.25

\* does not include rear storage



## WASTE CONTAINER FRAMES



### BOTTOM MOUNT WASTE CONTAINER FRAMES

Wood Frame and Slide Set only



4VLWCSC-18F  
Double Wood Frame



4VLWCSC-15F  
Single Wood Frame

Single and Double Bin Frames feature adjustable door mount brackets that will let you mount your cabinet door directly to your waste container frame for easy access.

Double wood frames can hold (2) 35 or 50 Qt bins. Single wood frames can hold (1) 35 or 50 Qt bin, and includes storage space in the rear.

Waste bins sold separately.

Standard	Dimensions	List/ea
4VLWCSC-15F	11-1/2"W x 21-1/2"D x 11.2"H	\$ 212.28
4VLWCSC-18F	14-1/2"W x 21-1/2"D x 11.2"H	219.21

### BOTTOM MOUNT WASTE CONTAINERS

Wood Value Line

- Features Value and Quality
- Full-ext, 75 lb. soft close concealed slides
- Mounts to cabinet door and floor
- Dovetail plywood box w/ (2) 27 qt. white bins



Designed for 15" base cabinets, these waste containers feature a dovetail plywood box with a semi-gloss finish, two 27 quart white waste containers, soft-close slides and door mount brackets with 5" of adjustability and a micro-trim adjuster.

Dims:

11-1/2" W x 21-1/2" D x 19-11/16" H

Code	MCO FF	MCO FL	List/ea
4VLWCSC-1527DM-2	11-1/2"	11-3/4"	\$ 261.05



## WASTE CONTAINERS

### ENVI 24" SPACEPRO DISPOSAL UNITS

Soft-Close, 2 bin set



Cabinet Dimensions

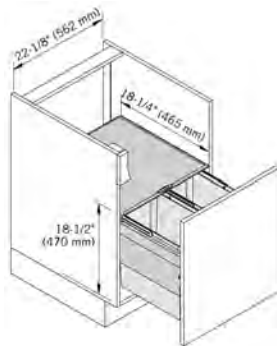

- Base cabinet width: 24"
- Min opening width: 22-1/8" - 22-1/3"
- Installation depth: 18-5/16", Installation height: 18-1/2"
- Integral 3-D front adjustment, soft-closing and self-closing. Slide is smooth rack & pinion design
- Metal frame is silver powder coat finish
- Additional storage on powder-coated removable lid
- Max capacity: 60 Qts. (2 bins, 30 Qts. each)

#### Product Dimensions

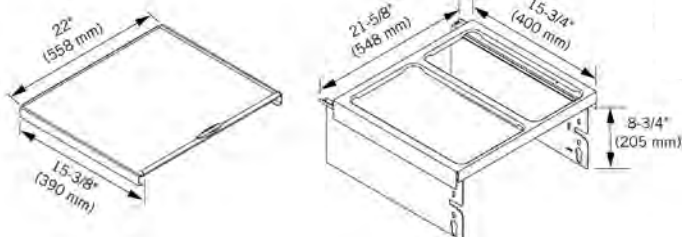

Code	Description	List/ea
90003697	ENVI Space Pro, 24" with 2 x 30 qt bins	\$ 398.33

### ENVI KICK - KICK TO OPEN - For Frameless Cabinets



Min. Toe Kick:  
 70mm (2-3/4")

- Quiet, hands-free door opening using a foot pedal
- Retrofittable in any pull-out system with front opening
- Will not create scratch marks
- Pedal returns to start position by way of spring. Virtually silent.

Code	Description	List/ea
90006930	ENVI Toe-Kick opener	\$ 41.67

### ENVI 15" SPACEPRO DISPOSAL UNITS

Soft-Close

Large capacity in a small cabinet.



Silver Powder Coat Finish

- Built-in **soft-closing** and self-closing
- Ultra Smooth concealed full-ext. (Grass) slides
- Two 37 Qt grey bins w/ handles
- 3D door adjustment bracket for tilt, height, overlay
- Min Height: 22"
- Min Depth: 20-5/16"
- Min Opening width: 15"

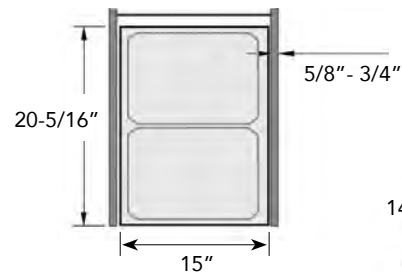

Product Dims

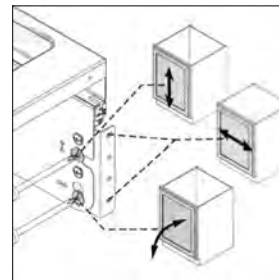
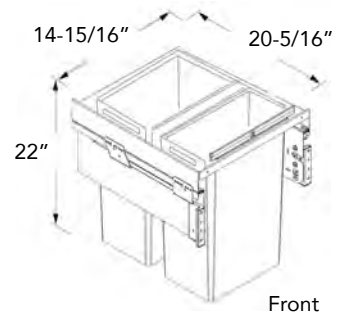

Door bracket adjustment:  
 Tilt, Height, Overlay

Code	Description	List/ea
90009329	Envi Space Pro; 15" frame	\$ 302.29
91001497	Grey 37 Quart bins (2 required for complete set)	39.02





## WASTE CONTAINERS

### BOTTOM MOUNT WASTE CONTAINERS

53WC - Soft Close



- Double 27 Qt. silver waste containers
- Full extension, 90 lb concealed slides w/ soft-close
- Powder coated silver wire frame
- Mounts to cab floor

Dimensions:  
 11-1/4" W x 22-1/8" D x 19" H

Code	Description	MCO	List/ea
53WC-1527SCDM-217	Bottom Mount, Double 27 Qt Silver Bin Set	11-1/2"	\$ 269.84

### BOTTOM MOUNT WASTE CONTAINER FRAME

53WCF - Soft Close



Frame, Slides, and Brackets only!



- Bins and Lids sold separately!  
 Order: RV-35-17-8 or RV-50-17-8 (see page 1647)
- Single and Double 35 Qt. Soft Close Frames
- Full Extension Soft-Close slides - 90 lbs. cap.
- Rear storage on all single units
- Door mount brackets included
- Fast and easy installation

Code	Dimensions	MCO
53WCF-117SC-48	10-7/8" W x 22-1/4" D x 19" H	11-1/2"
53WCF-217SC-48	14-3/8" W x 22-1/4" D x 19" H	15"

Code	Description	List/ea
53WCF-117SC-48	Single 35 Qt. Frame	\$ 194.45
53WCF-217SC-48	Double 35 Qt. Frame	194.45

### UNDER SINK MOUNT WASTE CONTAINERS

Features 2 Stainless Steel Bins



8-785-30-DM2SS



Removable Cans

- Door mount undersink waste container
- Full-Extension, ball bearing slides
- Fits in limited spaces around existing plumbing
- Built-in polymer lid
- Unit has two stainless steel bins:  
 One 10 liter (2.64 gal) bin and One 20 liter (5.28 gal) bin, a covered lid and built in handles for easy removal

Dimensions:  
 10-1/4" W x 18-3/4" D x 15-3/16" H

Code	Description	MCO	List/ea
8-785-30-DM2SS	Door Mount Under Sink Waste Containers	11"	\$ 457.26

### BINS & LIDS FOR 53WCF

See page 1646 for pricing



White 35 Qt. bin



Silver 35 Qt. bin



Silver

White

Bin	Lid	Size	Color
RV-35-8	RV-35-LID	35 Quart	White
RV-35-17-8	RV-35-LID-17	35	Silver
RV-50-8	RV-50-LID	50	White
RV-50-17-8	RV-50-LID-17	50	Silver



## WASTE CONTAINERS

### TOP MOUNT SINGLE WASTE CONTAINERS

4WCTM Soft Close Series / For Face Frame



Top Mount  
Soft-Close

Available in 35  
and 50 Quart  
Containers

Optional Lids  
available - see  
page

4WCTM-12BBSCDM1



Soft-Close Slide and  
Floating Rear Bracket

#### 4WCTM-12BBSCDM1 Features:

- Single 35 Quart silver container
- 1-1/2" over travel soft-close ball-bearing slides
- Includes rear polymer storage bin
- Pre-assembled door mounting brackets
- Innovative floating bracket that ensures soft-close functionality even when your cabinet wood swells or shrinks

Dimensions: 12" W x 22-3/4" D x 17-7/8" H

#### 4WCTM-1550BBSCDM-1 Features:

- Single 50 Quart silver container
- 1-1/2" over travel soft-close ball-bearing slides
- Pre-assembled door mounting brackets
- Rear adjustable mounting brackets for variances in cabinet depth

Dimensions: 12" W x 23-1/4" D x 21-3/4" H

Code	Description	MCO	List
4WCTM-12BBSCDM1	Single 35 Qt. Silver Bin w/ Storage Bin included	12"	\$ 177.59
4WCTM-1550BBSCDM-1	Single 50 Qt. Silver Bin w/ Storage Bin included	12"	186.64

### TOP MOUNT DOUBLE WASTE CONTAINERS

4WCTM Soft Close Series / For Face Frame



Top Mount  
Soft-Close

Available in 27,  
35 and 50 Quart  
Containers

Optional Lids  
available - see  
page

4WCTM-18BBSCDM2

Designed for absolute sturdiness with front side mounting, rear adjustable mounting brackets for variances in cabinet depth and a floating bracket that ensures soft-close functionality even when your cabinet wood swells and shrinks. Complete with pre-assembled door mounting brackets and 1-1/2" overtravel soft-close ball-bearing slides.



- Floating bracket ensuring soft-close functionality
- Pre-assembled door mounting brackets
- Rear adjustable mounting brackets for variances in cabinet depth

#### MCO

4WCTM-15BBSCDM2	12"
4WCTM-18BBSCDM2	15"
4WCTM-2150BBSCDM-2	18"

Code	Description	List
4WCTM-15BBSCDM2	Double 27 Qt. Silver Bins 12" W x 23-1/4" D x 17-3/4" H	\$ 212.69
4WCTM-18BBSCDM2	Double 35 Qt. Silver Bins 15" W x 22-3/4" D x 17-7/8" H	213.24
4WCTM-2150BBSCDM-2	Double 50 Qt. Silver Bins 18" W x 23-1/4" D x 21-3/4" H	227.32



## WASTE CONTAINERS



### 4WCTM SERIES TOP MOUNT WASTE CONTAINERS

These pull-out waste containers all have 150 lb. full extension over-travel slides and a maple frame. Each unit has three mounting options: Front, rear and door. White polymer containers. Optional Lids available - see page 1646.



#### **27 QUART - DOUBLE BIN**

Width: 12"  
Depth: 23-1/4"  
Height: 17-3/4"

Comes with two 27 quart white polymer bins.

<u>Code</u>	<u>List</u>
4WCTM-15DM2	\$ 205.55



#### **35 QUART - DOUBLE BIN**

Width: 18" or 21"  
Depth: 22-3/4"  
Height: 17-7/8"

Comes with two 35 quart white polymer bins.

<u>Code</u>	<u>Width</u>	<u>List</u>
4WCTM-21DM2	18"	\$ 219.22
4WCTM-24DM2	21"	244.98



#### **35 QUART - SINGLE BIN**

Width: 12"  
Depth: 22-3/4"  
Height: 17-7/8"

Extra storage compartment behind single bin.

<u>Code</u>	<u>List</u>
4WCTM-12DM1	\$146.14



#### **50 QUART - SINGLE BIN**

Width: 12"  
Depth: 23-1/4"  
Height: 21-3/4"

Extra storage compartment behind single bin.

<u>Code</u>	<u>List</u>
4WCTM-1550DM-1	\$ 159.77

16



#### **35 QUART - DOUBLE BIN**

Width: 15"  
Depth: 22-3/4"  
Height: 17-7/8"

Comes with two 35 quart white polymer bins.

<u>Code</u>	<u>List</u>
4WCTM-18DM2	\$ 176.21



#### **50 QUART - DOUBLE BIN**

Width: 18"  
Depth: 23-1/4"  
Height: 21-3/4"

Comes with two 50 quart white polymer bins.

<u>Code</u>	<u>List</u>
4WCTM-2150DM-2	\$ 194.20



## WASTE CONTAINERS

### REV-A-SHELF RV SERIES PULL-OUT WASTE CONTAINERS

Heavy duty wire frame construction. White polymer bins (except RUKD series which has gray bins). Easy 4 screw bottom-mount installation. Packaged fully assembled. Optional Door Mount Kits - see page 1645. Optional Lids available - see page 1646.

#### RUKD - Single 20 Qt. w/ Full Ext. Ball Bearing Slides



RUKD-820-1  
8-5/8"W x 15-3/4"D x 16-5/8"H

when rotated:  
14-1/2"W x 15-3/4"D x 16-5/8"H

- Multi-purpose design for dual configuration for under sink applications
- Chrome plated wire frame construction
- Full ext. ball-bearing 100 lb. slides

Code	Description	MCO	List
RUKD-820-1	Single 20 Qt Bin	8-1/2" (14-1/2")	\$ 87.93

#### RV-9PB - Single 30 Qt. w/ 3/4 Extension Slides



3/4 Extension Ball-Bearing Slides - 100 lb. weight rating. Optional Door Mount Kit.

9-1/2"W x 22"D x 19-1/4"H

Code	List
RV-9PB	\$ 99.08

RV-9PB

#### RV-12PB - Single 35 Qt. w/ 3/4 Extension Slides



3/4 Extension Ball-Bearing Slides - 100 lb. weight rating. Optional Door Mount Kit.

10-5/8"W x 22"D x 19"H

Code	List
RV-12PB	\$ 92.52

RV-12PB  
Shown with optional door mount kit

#### RV-12PB-50S - Single 50 Qt. w/ Lid & Full Ext. Slides



Full Extension Ball-Bearing Slides. 100 lb. weight rating. Optional Door Mount Kit.

12-1/4"W x 22"D x 24-1/4"H

Code	List
RV-12PB-50S	\$ 110.23

#### RV-15PB-2S - Double 27 Qt. with Full Ext. Slides



Full Extension Ball-Bearing Slides. 100 lb. weight rating. Optional Door Mount Kit.

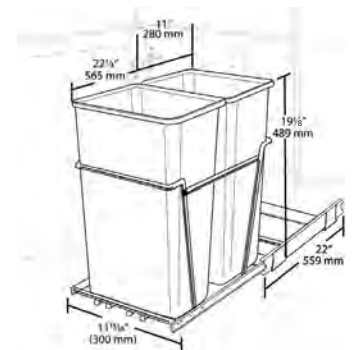

Code	Dimensions	List
RV-15PB-2S	11-13/16"W x 22-1/4"D x 19-1/8"H	\$ 151.23

#### RV-18PB-2S - Double 35 Qt. with Full Ext. Slides



Shown with optional door mount kit

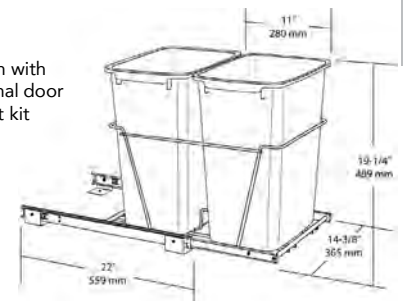

Full Extension Ball-Bearing Slides. 100 lb. weight rating. Optional Door Mount Kit.

Code	Dimensions	List
RV-18PB-2S	14-3/8"W x 22"D x 19-1/4"H	\$ 174.38



## WASTE CONTAINERS



### RV SERIES PULL-OUT WASTE CONTAINERS

Chrome Frame Construction and Black or Silver Bins



RV-18KD-18CS

- Easy Bottom mount installation
- Optional Door Mount Kit: RV-DM17 KIT (see next column)

- Heavy Duty Chrome Wire Frame construction
- Double 27 Qt and 35 Qt bins, black or silver finish
- Full ext, ball bearing 100 lb. slides

RV-15KD-17CS



	<u>Dimensions</u>	<u>MCO</u>
RV-15KD-	11-13/16"W x 22-1/4"D x 19-1/4"H	12"
RV-18KD-	14-3/8"W x 22"D x 19-1/4"H	14-1/2"

<u>Code</u>	<u>Description</u>	<u>List/ea</u>
RV-15KD-17CS	Double 27 Qt. w/ Silver Bins	\$ 117.54
RV-15KD-18CS	Double 27 Qt. w/ Black Bins	135.91
RV-18KD-17CS	Double 35 Qt. w/ Silver Bins	153.93
RV-18KD-18CS	Double 35 Qt. w/ Black Bins	153.91

### UNDERSINK DOUBLE PULL-OUT WASTE CONTAINER

5SBWC Series

- For 24" and larger sink base cabinets
- Double metallic silver bins with handles:
  - (1) 15L (about 16 Qts) and
  - (1) 8L (about 8.5 Qts)
- Full-extension, 75 lb. soft close slides



- Includes (1) white lid and (1) green lid
- Door mount kit sold separately: 5WB-DMKIT

	<u>Dimensions</u>	<u>MCO</u>
	8-15/16"W x 18-5/8"D x 14-1/4"H	9-1/4"

<u>Code</u>	<u>Description</u>	<u>List/ea</u>
5SBWC-815S-1	Undersink Wire Double Waste Container Pull-out	\$ 161.99
5WB-DMKIT	Door Mount Kit	36.16

### REV-A-SHELF HEAVY DUTY DOOR MOUNT KIT



RV-DM17-KIT

- Fits all RV Series Waste Containers
- Fits all HPRV/HRV Hampers
- Fits all 5CW2 Series Cookware Organizers
- Allows cabinet door to be installed easily
- Six-way adjustable bracket
- Includes a complete set of brackets, fasteners and spacers for installation
- Eliminates the need for a sub door panel

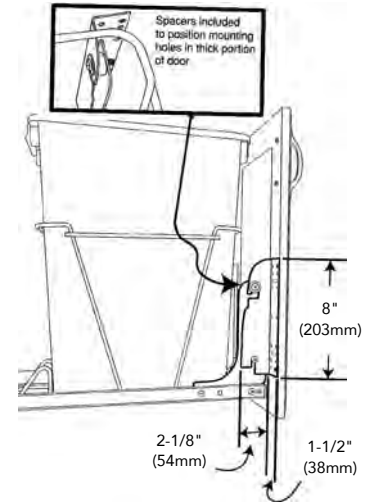

Spacers allow custom installation onto any door style. Door brackets can be faced in or out to ensure mounting to the thick portion of your cabinet door.

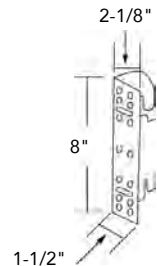

The door mount bracket flange is designed to be able to overlay the face frame of a cabinet. Once installed, the material thickness of 1/8" is less than any standard "bumper pad". Thus, it will not make contact or otherwise interfere with the front of the face frame.

Includes all brackets and fasteners needed for one door. Available in White or Silver.

<u>Code</u>	<u>Description</u>	<u>List/ea</u>
RV-DM KIT	Door Mount Kit, White	\$ 38.57
RV-DM17-KIT	Door Mount Kit, Silver	43.09

RV-814PB and VL-9PB require the Euro Adapter Kit:

RV-8DMADP	Euro Adapter Kit	N/C
-----------	------------------	-----



## WASTE CONTAINERS

## LIDS

### REPLACEMENT WASTE CONTAINERS

#### White Polymer Waste Containers



Code	Size	Where Used
RV-20-6	20 Quart	RV-8, RV-14
RV-1024W	27 Quart	RV-15, 4WC TM-15, 5149, 5349
6700-61-B	30 Quart	RV-9, EZ-300, 568 Series
RV-35-8	35 Quart	RV-12, RV-18, 5149, 5349 and 4WC Series, 53WC Series
RV-50-8	50 Quart	RV-12PB-50 and 4WC Series

Code	Dimensions	List/ea
RV-20-6	8-3/8"W x 14-1/4"D x 15"H	\$ 15.11
RV-1024W	11"W x 10-7/8"D x 17-3/4"H	24.03
6700-61-B	9-3/8"W x 15-3/8"D x 17-7/8"H	23.53
RV-35-8	14-3/16"W x 10-1/2"D x 17-7/8"H	15.31
RV-50-8	14-3/4"W x 10-3/4"D x 21-3/4"H	27.70

#### Silver Polymer Waste Containers



Silver  
35 Qt.

Code	Size	Where Used
RV-35-17-8	35 Quart	5149, 5349, 4WCSD, 4WCSC, RV Series, 53WC Series
RV-50-17-8	50 Quart	5149, 5349, 4WCSD, 4WCSC, RV Series, 53WC Series

Code	Dimensions	List/ea
RV-35-17-8	14-3/16"W x 10-1/2"D x 17-7/8"H	\$ 21.93
RV-50-17-8	14-3/4"W x 10-3/4"D x 21-3/4"H	30.33

### LIDS FOR 35 QT AND 50 QT CONTAINERS

Rev-A-Shelf Polymer flip-up lids for their most popular waste containers.

Available for 35 Quart and 50 Quart containers.

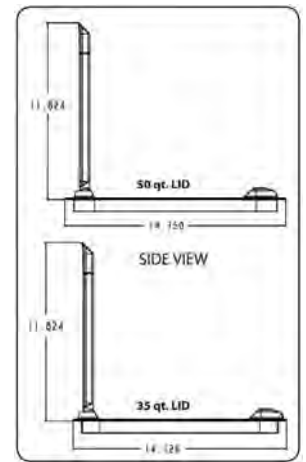
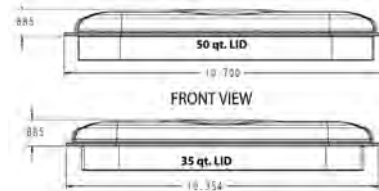

\* These lids will add to the height of the waste containers. We recommend adding 1" to the height. Be sure to take this dimension into account when measuring your cabinet.

Code	Description	List/ea
RV-35-LID	35 Qt. Container Lid - White	\$ 21.39
RV-35-LID-17	35 Qt. Container Lid - Silver	21.80
RV-35-LID-G	35 Qt. Container Lid - Green	21.80
RV-50-LID	50 Qt. Container Lid - White	20.81
RV-50-LID-17	50 Qt. Container Lid - Silver	23.40
RV-50-LID-G-1	50 Qt. Container Lid - Green	23.40

Other colors available special order.

## WASTE CONTAINERS

### REV-A-SHELF PIVOT-OUT WASTE CONTAINERS

Built-In



8-010314-15

For under kitchen  
 or vanity sinks



8-010412-15

White Lacquer or Stainless Steel 15 liter (3.96 Gal) containers. When the door opens, the lid opens and the container moves out for total accessibility. When the door is closed, the container swings back in and the lid closes automatically. Features a black, inner polymer container with built-in handle for easy removal. Can be installed on a left or right hand door - mounts to cabinet door and side walls.

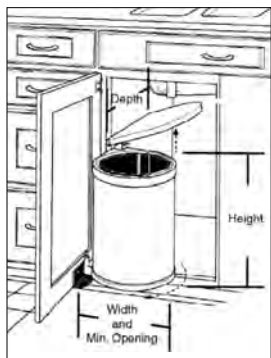

8-010314-15 (Stainless Steel)  
 8-010412-15 (White)  
 Dimensions:  
 11-3/4" W x 10-1/2" D x 15-3/16" H



Code	Description	MCO	List/ea
8-010314-15	Pivot-Out Waste Bin, Stainless Steel	13-3/4"	\$ 144.17
8-010412-15	Pivot-Out Waste Bin, White Lacquer	13-3/4"	115.44

### MAPLE DOOR MOUNT WASTE CONTAINERS

Mounts to cabinet door



- For 30" base cabinets
- Single 8 qt. polymer container, metallic silver and (1) white lid
- Maple dovetail frame with semigloss finish
- Mounts to cabinet door
- Pre-assembled adjustable door mount brackets



Simply mounts to your cabinet door for easy access. The bin features built in handles and a removable lid.

10-3/8" W x 7-3/8" D x 12-5/16" H, MCO: 12-3/4"

Code	Description	List/ea
4SOWC-8-1	Maple Door Mount, Swing Out 8 Qt. Waste Container	\$ 91.15

### DROP OUT CABINET FIXTURES - Special Order

Countertop and Tilt-out Waste Disposal



The 8012 Tilt Waste goes next to the sink, high in the base cabinet. The wastebasket is easy to open and allows for a quick sweep, directly in the trash. Requires top face-frame rail with 3/4" min lip. Includes: (1) Door mount frame, (1) 24 Qt. bin and 35mm soft close hinges.

The 8014 Countertop Covered Waste has a pop-up sealed Stainless lid; for compost into a 9 Qt. removable bucket.

#### All Special Order.

Code	Description	List/ea
8012	Tilt-out Waste System	\$ 250
8014	Countertop Waste System	548



## RECYCLING CENTERS

### RECYCLE CENTER - SOFT CLOSE

5BBSC Series



Soft-Close  
Recycle Center

Dimensions:  
20" W x 22-1/4" D  
x 20-1/4" H

Includes three 25 Quart color polymer bins that allow for easy sorting of plastic, glass and metal, and contains a machine washable canvas bag for recyclable paper products. Features chrome frame and 150 lb. ball-bearing soft-close slides. Includes adjustable door mount brackets.

Code	Description	MCO	List
5BBSC-WMDM24-C	Recycle Center, Soft Close	21"	\$ 446.14

### TOP MOUNT WASTE CONTAINERS - 4 BINS

Metal Frame, Soft Close



- Double 35 Qt and Double 8 Qt Silver bins
- Powder coated metal frame, metallic silver
- Full extension, w/ 1-1/2" over-travel, Grass soft-close slides
- Pre-assembled door mount brackets

Rev-A-Shelf 53TM metal frame waste containers are designed for full access 24" cabinets and features full-extension with 1-1/2" over-travel Grass, soft-close slides and a built-in metal lid. The 8 qt. containers include (1) green and (1) white lid.

Dimensions:  
22-1/8" - 22-3/4" W x 21-11/16" D x 19" H

Code	Description	MCO	List
53TM-24GSCDM4-FL	4 Bin waste containers	22-1/2"	\$ 448.54

### SOFT-CLOSING ECARGO RECYCLING CENTER

E-Cargo Recycling Center with Soft Close - designed for door mounting. Silver grey finish. 110 lbs load.

Includes (2) 38L, (1) 12L, (1) 2.5L Grey Bins

22-1/8" - 22-3/8"  
Net Opening Width,  
20-3/4" Depth,  
21-1/2" Height



- Covered slides helps avoid the accumulation of dust and ensures a longer life
- Over extension slides provide complete access to bins
- Bin equipped with handles for maneuverability
- Lid prevents odors from escaping and provides additional space for recycling newspapers, etc.
- Easy 3-way front adjustment (cam adjustment screw)

Code	Description	List/ea
ECARGO-60-GY	Recycling Center, 4 bin, Soft Close	\$ 653.09



## PILASTER SYSTEMS

### 4PIL SERIES PILASTER SYSTEM



A truly customized pilaster system. Completely adjustable to work with different cabinet openings and work around hinges. Pilaster uprights only - slides and drawer kits special order. Steel material, silver finish.



#### Pilaster dimensions:

Width: 1" to 1-3/8"  
 Depth: 1"  
 Height: 21"

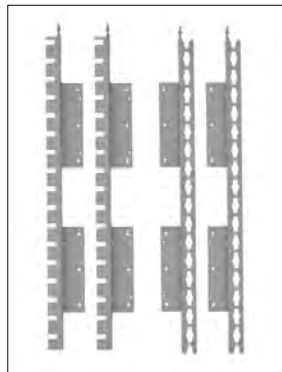

- Designed for 18" and 24" base cabinets
- Stackable for use in pantry applications
- Easily adjustable drawer height locations for storing tall and short items
- Sets contain 12 buttons to connect slides



Code	Description	Ctn	List/St
4PIL-21-SV-1	Pilaster Upright Kit, Silver	1	\$ 94.26
4PIL-21-SV-10	Pilaster Upright Kit, Silver BULK: Must order sets in increments of 10.	10	80.37

### X-SERIES BRACKET SYSTEM

For Adjustable Roll-Outs



High quality, simple, tool-free adjustability for roll-out shelving systems. Installation is quick and easy.

For use with undermount and side mount slides.

**ADJUSTABILITY:** Tool-free adjustability allows users to quickly and easily change their shelving heights to adapt to their evolving needs.

**DURABILITY:** Solid, Appalachian Maple pilasters and high strength, metal brackets have been tested to 400,000+ open/close cycles with a 100 lb. load without any impact on function.



Sets come with brackets and are available with pilaster widths of 1-1/4" or 2-1/2".

- XB150** - Pilaster Ht of 20-7/8" for std height base cabinets
- XB250** - Pilaster Ht of 27-1/8" for full height base cabinets
- XB550** - Pilaster Ht of 58-5/8" for pantry cabinets.



Undermount Installation



Side Mount Installation

Code	Kit Descriptions	Pilaster Width	List
XB150N	8 Brkts, (4) 20-7/8" Pilasters	1-1/4"	\$ 139.80/st
XB150W	8 Brkts, (4) 20-7/8" Pilasters	2-1/2"	183.00
XB250N	8 Brkts, (4) 27-1/8" Pilasters	1-1/4"	175.00
XB250W	8 Brkts, (4) 27-1/8" Pilasters	2-1/2"	230.00
XB550N	20 Brkts, (4) 58-5/8" Pilasters	1-1/4"	320.18
XB550W	20 Brkts, (4) 58-5/8" Pilasters	2-1/2"	384.18
XB1	Brackets only (1 set for 1 rollout)		29.26/bx
XB20	Brackets only (20 sets for 20 rollouts)		468.35
XBSCREW	Xtra screws for X-Series brackets		.15/ea

## ROLL OUT SHELVES

## BASKET PULL-OUTS

### QUICK TRAY™ ROLLOUT SYSTEM

Tenn-Tex Plastics

QuikTray Support  
 20-1/8" length



#### **1" Supports for Frameless Cabinetry**

Rollout tray application in frameless cabinet. Concealed hinges and epoxy-coated metal-sided drawer.

Code	Color	List/bg
B520-01B	Beige	\$ 40.72
B520-00W	White	40.49



#### **1-1/4" Supports for Face Frame Cabinetry**

Face frame cabinet with low profile face frame hinges.

Code	Color	List/bg
B522-01B	Beige	\$ 39.23
B522-00W	White	28.78



#### **2" Supports for Face Frame Cabinetry with Face Frame Adapter Baseplates**

Long-arm hinge and face frame adapter baseplate application.

Code	Color	List/bg
B525-01B	Beige	\$ 61.89
B525-00W	White	41.99

Use on faceframe or frameless cabinets and with any brand of drawer slides. Shelves can be adjusted vertically in 1-1/4" increments. Non-handed. Tool-free adjustment. 75 lb. dynamic, 150 lb. static.

Patented Hook Dowel makes installation easy: simply slide the dowel into the holes and lock into place. No tools required.

Easy tray Height Adjustment: Lift up on slide to unhook and move it to the new position.

Bag includes: 4 Supports, 8 Hook Dowels, and 8 machine screws (6-32 x 3/8).

### WOVEN BASKETS WITH RAILS

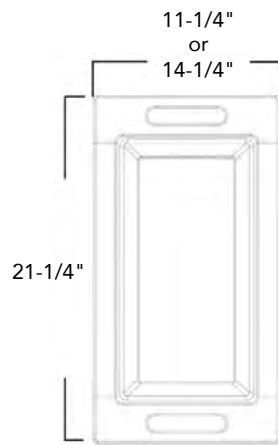

Basket width only (no rails)

- Features machine washable canvas liners
- Basket secured within a natural maple frame, complete with built-in handles
- Easy four screw installation for side mount rails

Code	Width before rails are cut	Min. after rails are cut	Depth	Height
4WV-15MP	14-1/2"	12-1/4"	21-1/4"	7-3/8"
4WV-18MP	17-1/2"	15-1/4"	21-1/4"	7-3/8"

Code	Description	List
4WV-15MP	Base 15 Woven Basket	\$ 186.28
4WV-18MP	Base 18 Woven Basket	195.42

## ROLL OUT SHELVES



### SINGLE PULL-OUT CHROME BASKETS

5WB1 - Load Rating: 100 lbs.

These pull-out chrome baskets are ideal for organizing pots, pans and other bulky items.

Baskets feature full-extension ball-bearing slides, Heavy-Duty Chrome plated frames, and are easy to install.



Slide units install easily with only four screws!

All units 7" Height.

<u>Code</u>	<u>Width x Depth</u>	<u>MCO (FF)</u>	<u>List/ea</u>
5WB1-0918-CR	8-3/8"W x 18"D	8-1/2"	\$ 74.24
5WB1-1222-CR	11-3/8"W x 21-11/16"D	11-1/2"	97.43
5WB1-1522-CR	14-3/8"W x 21-11/16"D	14-1/2"	106.76
5WB1-1822-CR	17-3/8"W x 21-11/16"D	17-1/2"	117.03
5WB1-2122-CR	20-3/8"W x 21-11/16"D	20-1/2"	125.70
5WB-DMKIT	Door Mount Kit 5WB Series		36.16

### TWO TIER PULL-OUT CHROME BASKETS

5WB2 - Load Rating: 100 lbs.



Double Basket has full-extension, ball-bearing slides and chrome plated baskets. To install, simply mount the bottom bracket to the cabinet floor, then attach the upper bracket using the back of the cabinet and face frame.

Available in 18" or 22" slides and four widths to fit in kitchens, bath and laundry. All units 19" Height.

#### With 18" Slides

<u>Code</u>	<u>Width x Depth</u>	<u>MCO (FF)</u>	<u>List</u>
5WB2-0918-CR	8-3/4"W x 18"D	8-1/2"	\$ 151.61
5WB2-1218-CR	11-3/4"W x 18"D	11-1/2"	168.92

#### With 22" Slides

5WB2-1222-CR	11-3/4"W x 21-11/16"D	11-1/2"	\$ 192.12
5WB2-1522-CR	14-3/4"W x 21-11/16"D	14-1/2"	202.94
5WB2-1822-CR	17-3/4"W x 21-11/16"D	17-1/2"	223.31
5WB2-2122-CR	20-3/4"W x 21-11/16"D	20-1/2"	238.77

#### Door Mount Kit

<u>Code</u>	<u>Description</u>	<u>List</u>
5WB-DMKIT	Door Mount Kit 5WB Series	\$ 36.16



## ROLL OUT SHELVES

### PREMIER PULL-OUT SHELVES

5730 Series



5730 Series available bottom mount, side mount or door mount.

#### Side Mount Dimensions:

Code	Description	Width Min.	Width Max.
5730-21CR	21" Pull-out	20-5/16"	22-11/16"
5730-33CR	33" Pull-out	32-3/8"	34-3/4"

Premier Pull-out Shelves to organize all your cooking essentials. Features full-extension undermount soft-close slides as well as adjustable mounting brackets that enable you to affix the unit to the floor or walls of the cabinet. Door mount brackets also included, allowing up to five inches of flexibility for easy installation on any door style. Chrome finish.

All 21-3/4" Depth and 5-5/8" Height.

Code	Description	MCO	List
5730-21CR	Pull-out Shelf, 20-11/16"	20-1/2"	\$ 298.47
5730-33CR	Pull-out Shelf, 32-11/16"	32-1/2"	326.21

### TWO-TIER COOKWARE ORGANIZER

5CW2 Series



5CW2-1222

Top Tier Storage for up to 7 lids. Bottom Tier with adjustable dividers can store a variety of pots and pans.

5CW2-2122

Top Tier Storage for up to 14 lids. Bottom Tier with adjustable dividers can store a variety of pots and pans.



(shown with door mount)

The 5CW2 features independently operating shelves. The top tier organizes lids and the bottom tier features adjustable dividers to store a variety of pans. Made with a heavy-duty chrome plated wire frame.

Glides on 100 lb. rated full-extension ball-bearing slides. Now available with Soft Close slides! The bottom, side, and rear mounting provides stability. Installs easily. Optional Door mounting kit available with the 5WB-DMKIT.

#### Product Dimensions

5CW2-1222	11-3/4" W x 22" D x 18" H
5CW2-2122	20-3/4" W x 22" D x 18-1/8" H

Code	Description	MCO	List/ea
5CW2-1222-CR	Two Tier Cookware Organizer	12"	\$ 191.09
5CW2-2122-CR	Two Tier Cookware Organizer	21"	327.02
5CW2-1222SC-CR	Two Tier Cookware Organizer, Soft Cl	12"	229.12
5CW2-2122SC-CR	Two Tier Cookware Organizer, Soft Cl	21"	374.79
5WB-DMKIT	Door Mount Kit		36.16

## PULL DOWN SHELVES

## KITCHEN STORAGE

### REV-A-SHELF PULL-DOWN SHELVING SYSTEM



5PD-24CR  
 or  
 5PD-36CR

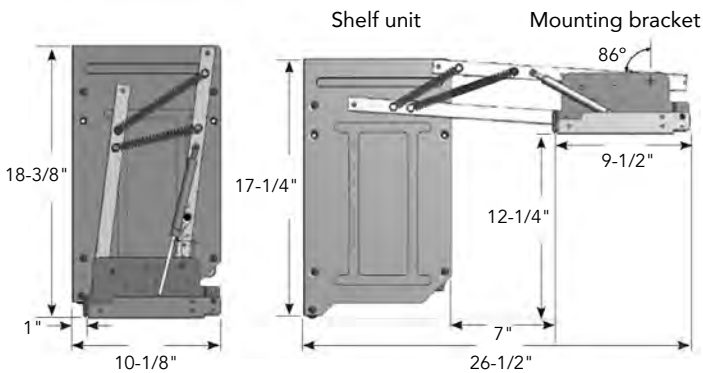

Rev-A-Shelf's pull down shelving system can bring top shelf items to your fingertips. Available for wall 24 and 36 cabinets. Both sizes lower hard-to-reach items 11-1/2" while pulling out 16-3/4" from the cabinet. Unique gas assisted lifting/lowering mechanism provides unparalleled stability through the entire range of motion. Side and bottom mount brackets are included. Locks into down position for hands-free accessibility.

5PD-24CR For Wall 24" Cabinets  
 5PD-36CR For Wall 36" Cabinets

Both units 10-1/8" Depth, 18-3/8" Height

Code	Width	MCO		List
		FF	FL	
5PD-24CR	22-1/4"	21"	22-1/2"	\$ 762.35
5PD-36CR	34-1/4"	33"	34-1/2"	802.05

MCO = Minimum Cabinet Opening  
 FF = Face Frame, FL = Frameless

### Glideware®

#### CABINET ORGANIZERS



- 7 Fully adjustable/removable hooks
- Solid natural maple construction



GLD-W22-BC-7  
 Undermount Glides



GLD-W22-SC-7  
 Side Mount Glides



Made in USA

- Available with either side mount slides or undermount slides
- **Handcrafted:** Solid natural maple construction. Made in the USA.
- **Heavy Duty:** Designed to accommodate heavy cookware up to 100 lbs.
- **Accessible:** Fully extends out of the cabinet
- 7 hooks on each unit are fully adjustable and removable to accommodate any shape or size of cookware. Hooks and glides made from zinc.

Min. Cabinet Opening: 22-3/4"

Code	Description	List/ea
GLD-W22-SC-7	Glideware w/ 22" Side Mount Slide 4" W x 22" D x 4-7/8" H	\$ 160.75
GLD-W22-BC-7	Glideware w/ 22" Undermount Slide 6" W x 22" D x 5-7/16" H	346.30



## KITCHEN STORAGE

### REV-A-SHELF DOOR STORAGE SYSTEM

Trays and standards are ordered separately. Standards allow 1" adjustments. Trays are 4" D x 2-1/2" H in front and 3-9/16" H in rear. Trays are white polymer and come with screw-in clips. Standards are bright aluminum and come with shelf clips.

Available in two or five tray sets, and in two widths.



#### 2-Shelf Kit with Screw-In Clips

<u>Code</u>	<u>Width</u>	<u>List/st</u>
6232-14-11-52	13-3/4"	\$ 26.88

#### 5-Shelf Kit with Screw-In Clips

<u>Code</u>	<u>Width</u>	<u>List/st</u>
6235-14-11-52	13-3/4"	\$ 63.42
6235-20-11-52	19-3/4"	73.08

#### Two standards with screws, mounting clamps and shelf clips

<u>Code</u>	<u>Size</u>	<u>List/pr</u>
6232-26-4528-52	26"	\$ 54.74
6232-58-4528-52	58"	83.84

#### Extra Clips for Door Storage System

<u>Code</u>	<u>Ctn</u>	<u>List/ea</u>
6231-41-4101	100 ea.	\$ 1.61



### REV-A-SHELF WOOD DOOR STORAGE TRAYS

4235-14-5 tray shown with included screw-in clips.



Birch/Maple wood trays with chrome accents are easily installed with included screw-in clips. Trays can also be mounted to 26" or 58" standards (sold separately).

#### Dimensions

14" Wood Tray:  
13-3/4" W x 4-1/4" D x 3-5/8" H

20" Wood Tray :  
19-3/4" W x 4-1/4" D x 3-5/8" H



Packed 5 trays per carton. Sold per each Tray.

<u>Code</u>	<u>Description</u>	<u>List/ea</u>
4235-14-5	14" Wood Tray	\$ 50.77
4235-20-5	20" Wood Tray	53.26

Two standards with screws, mounting clamps and shelf clips. Can be used for above storage trays.

<u>Code</u>	<u>Size</u>	<u>List/pr</u>
6232-26-4528-52	26"	\$ 54.74
6232-58-4528-52	58"	83.84



## KITCHEN STORAGE

### REV-A-SHELF TOWEL RACK

563-32CR

Available in Chrome.  
Stores up to 3 dish towels.

12-3/4" Width x 3-1/2" Depth  
x 6-1/2" Height



Code	Description	List/ea
563-32CR	Chrome Towel Rack	\$ 6.61

### KV SLIDING TOWEL RACKS



Towel Racks mount to side of cabinet and slide out for access to towels; retract to hide, leaving kitchen uncluttered. 1 per bx.

Code	Description	List/ea
793	3 Bars, Side Mount	\$ 50.44

### REV-A-SHELF TOWEL RACKS

2 Prong - Chrome

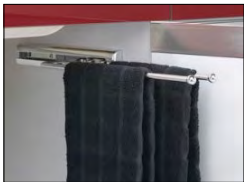

- Stores up to 2 towels
- Features a ball-bearing slide
- Easy 4 screw installation
- Left or Right hand mounting

3 Prong - Chrome or White



- Slides out of the cabinet 12" and stores up to 3 towels
- White or Chrome finish
- Universal brackets for Left or Right hand mounting
- Includes spacers for face frame installation

Code	Description	List/ea
563-47	White 3 Prong Towel Bar	\$ 32.20
563-47C	Chrome 3 Prong Towel Bar	34.93
563-51C	Chrome 2 Prong Towel Bar	33.06

### SUB SLIM PULL OUT TOWEL HOLDER

Soft Close



Vauth Sagel Sub Slim pull out towel holder with Integral soft-closing and self-closing on both runners.

Load cap: 13 lbs. max per shelf element. Chrome finish.



Towel Holder 90004111

- Side Mount installation
- Min Opening width: 4-3/8" (112mm)
- Installation depth: min. 19-1/2" (495mm)
- Installation height: min. 20-15/16" (532mm)
- Easy, tool-free installation
- Simple 3D front adjustment
- Integral soft closing and self closing on both runners

Code	Description	List/ea
90004111*	Sub Slim, w/ Chrome Towel Holder	\$ 192.50

\*disc when out

### SINK BASE WOOD DOOR STORAGE



- Designed for 15" and 18" cabinet doors
- Adjustable door mount brackets for up to 5" adjustability
- Natural maple construction with semi-gloss finish

Store cleaning supplies in a convenient spot under the sink with this wood door storage. The 4SBSU Series is made of Maple hardwood with a UV cured clear finish to ensure an acceptable match to any cabinet.

Code	Dimensions	MCO	List
4SBSU-15	10-1/2"W x 5"D x 18-1/2"H	12"	\$ 84.22
4SBSU-18	13-1/2"W x 5"D x 18-1/2"H	15"	89.17



## KITCHEN STORAGE

### TRA-STA ORGANIZERS

Omega National



The Tra-Sta (tray-stay) is the perfect storage solution for cookie sheets, baking trays, and muffin pans. Four prefinished Maple veneer dividers slide in grooved and pre-drilled top and bottom rails. Designed to be fastened in multiple locations to accept a variety of pots, pans, or lids. Easily trimmable to fit any size cabinet.

Includes: 4 Finished Dividers, 23-3/4" x 23-3/4",  
8 Drilled Rails, 3/4" x 24"

Code	Description	List/st
TS2424	Tra-Sta Maple Organizers	\$ 172.02

### U-SHAPED TRAY DIVIDER

596-10CR-52

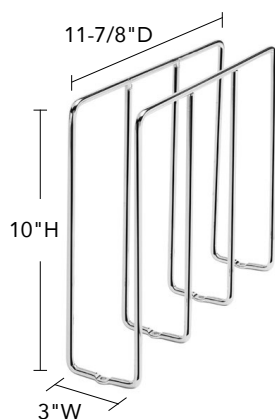

U-shaped, chrome finished tray divider has a simple bottom mount, four screw installation. Use one or more to create custom storage space.

Code	Dimensions	List
596-10CR-52	3"W x 11-7/8"D x 10"H	\$ 23.07

### TRAY DIVIDER WITH CLIPS

597 Series

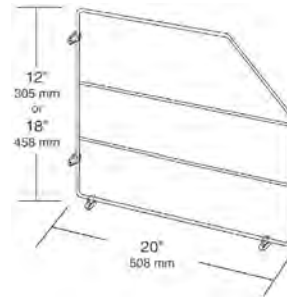

Tray dividers include screw-in clips and fasteners. Available in white or chrome, in 12" and 18" Heights.

Width: 3/4". Pack: 10/box with fasteners.

Code	Color	Height	Depth	List/ea
597-12	White	12"	20"	\$ 16.11
597-18	White	18"	20"	11.17
597-12CR	Chrome	12"	20"	12.38
597-18CR	Chrome	18"	20"	14.24

### SPARE CLIPS FOR 597 TRAY DIVIDER



Pack: 4 clips and screws per bag, 10 bags per carton.

Code	Color	Use for:	List/bg
209-26-99CR	Chrome	597-12CR, 18CR	\$ 3.42
209-26-99WH	White	597-12, 18	3.40

### CHROME TRAY DIVIDER

LD-597 Series

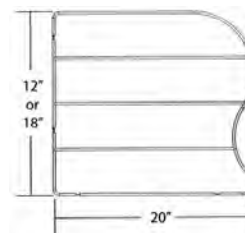

Heavy Duty chrome wire dividers screw directly into cabinet back and bottom. Available in 12" and 18" Heights.

Pack: 10 each/box.

Code	Height	Depth	List/ea
LD-597-12CR	12"	20"	\$ 13.99
LD-597-18CR	18"	20"	16.35



## KITCHEN STORAGE



### BASE CABINET PULL-OUT W/ TRAY DIVIDER / FOIL WRAP HOLDER 447 Series



447-BCSC-8C



447-BCSC-5C

Designed for 9" and 12" base cabinets. Two compartments for storing baking sheets and platters and removable center divider allows for larger platters/bakeware if desired. Door mount brackets provide up to 5" of adjustability for easy installation. T-Bar divider included to hold taller items in place. Includes full extension, 135 lb. slides with Soft-Close.

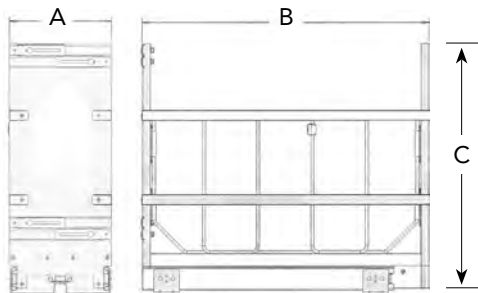

Dimensions	Width (A)	Depth (B)	Height (C)
447-BCSC-5C	6"	21-21/32"	19-1/2"
447-BCSC-6C	7-1/8"	21-21/32"	19-1/2"
447-BCSC-8C	8-3/4"	21-21/32"	19-1/2"
447-BCSC-9C	10-1/8"	21-21/32"	19-1/2"

#### All with Soft Close Slides

Code	FF	FL	List/ea
447-BCSC-5C	5-1/2"	6-1/8"	\$ 356.45
447-BCSC-6C	7-1/2"	7-1/2"	359.16
447-BCSC-8C	8-1/2"	8-3/4"	406.03
447-BCSC-9C	10-1/2"	10-1/2"	419.85

### REV-A-SHELF BREAD DRAWER COVER KIT



BDC-200



Bread drawer Cover Kits contain a one-piece cover with molded-in handle and rear stop, one pair of adjustable sliding rails and mounting screws. Can be trimmed to accommodate any drawer dimension. Available in two sizes.

BDC24-20



Code	Min. Trim Size
BDC-200-	11-5/8" x Any Depth
BDC24-20	16-1/16" x Any Depth

Code	Max Size	Color	List/ea
BDC-200-20	16-3/4"W x 21-3/4"L	Clear	\$ 63.05
BDC-200-11	16-3/4"W x 21-3/4"L	White	38.52
BDC24-20	20-1/8"W x 21-3/4"L	Clear	63.16

### TWO-TIER SINK BASE ORGANIZER

Keep items stored away in this easy to reach sink base pullout. Right or left hand mounting, chrome frame and ball-bearing slides.



- For 30" sink base cabinets
- Chrome-plated wire with L-shaped frame
- Mounts to cabinet side walls
- Non-handed, fits around plumbing

Code	Dimensions	MCO	List
548-10CR-1	9-3/4"W x 16"D x 18"H	10"	\$ 122.61



## UNDERSINK STORAGE

### UNDERSINK U-SHAPED PULL-OUT

Soft Close, Full Extension Slides



- Unique U-Shaped frame fits around obtrusive plumbing
- Soft-close, full-extension slides
- Provides easy access to stored items
- Bottom and side mount brackets included

Dimensions

5786-30CR 29-1/2" - 31-3/4"W x 22"D x 5-1/4"H

5786-33CR 32-1/2" - 34-3/4"W x 22"D x 5-1/4"H

Code	Description	MCO	List/ea
5786-30CR	Undersink Pull-Out w/ Soft Close	29-11/16"	\$ 383.36
5786-33CR	Undersink Pull-Out w/ Soft Close	32-11/16"	402.25

### SINK BASE CLEANING CADDY PULL-OUT

5CC Series



- Designed for 24" and larger sink base cabinets
- Single white container with handle
- Mounts to cabinet floor



Stocking 5CC-915S-11-1 in **WHITE** finish on basket.

Above shown with Orion Gray finish, available special order.

- Full-ext, undermount 75 lb concealed soft close slides
- Includes (2) 1 Liter spray bottles and a removable storage rack

Dimensions:

9-1/4"W x 18-5/8"D x 18-1/2"H

Code	Description	MCO	List/ea
5CC-915S-11-1	Cleaning Caddy Pull-out, White finish	9-1/2"	\$ 157.03

### REV-A-SHELF UNDERSINK CHROME BASKETS

544 Series

- Store multiple cleaning items in removable caddy
- Unique handle adjusts to accommodate plumbing fixtures
- Reversible/Removable top tray ideal for paper towels or sponge storage



Handle adjusts left/right for undersink pipes.



544-10C-1

Removable caddy allows you to take cleaning items with you and the added bottom bumpers provide stability and protect surfaces from marring.

Min Cab Opening: 11-1/2"

Code	Dimensions	List/ea
544-10C-1	11-1/4"W x 16-1/4"D x 19-1/2"H	\$ 115.30

### DRIP TRAY

SBDT Series



- Designed to protect from minor drips and leaks
- Easy wipe clean
- Unique front gravity design
- Can be cut down to fit a 27" or 33" cabinet



Protects the bottom of your cabinet by holding water, the tray actually funnels excessive water to the front of your cabinet and onto the floor alerting you of the leak. Designed for installation in 30 or 36" sink base cabinet construction, and the sleek surface makes for easy clean up. Almond in color.

	Tray Capacity	Min Trim
SBDT-2730	1-1/2 Qt	25-1/2" x 21-1/2"
SBDT-3336	1-3/4" Qt	31-1/2" x 21-1/2"

Code	Dimensions	List/ea
SBDT-2730-A	28-1/2"W x 23-1/4"D x 3/4"H	\$ 55.48
SBDT-3336-A-1	34-1/2"W x 23-1/4"D x 3/4"H	63.59

## SINK FRONT TRAYS



### REV-A-SHELF SINK FRONT TRAYS

Stainless Steel



Regular and Slim Series Stainless Steel Tip-Out Trays

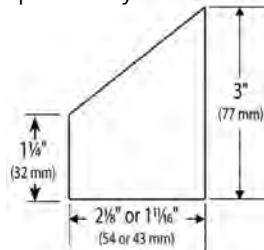

- Slim Series designed to accommodate minimum clearance openings for large sink applications
- Available in sizes ranging from 10" to 31"
- Hinges ordered separately - see next column

Pack: 20 each/box. Order hinges separately.

Regular Stainless Steel Trays, Depth = 2-1/8"

Code	Size (Width)	List/ea
6581-10-52*	10"	\$ 34.56
6581-11-5	11-1/4"	18.94
6581-13-5	13"	18.59
6581-14-5	14-1/4"	18.94
6581-16-5	16"	19.06
6581-19-5	19"	20.55
6581-22-5	22"	22.05
6581-25-5	25"	23.90
6581-28-5	28"	26.87
6581-31-5	31"	29.72

\*Includes hinges

Slim Stainless Steel Trays, Depth = 1-11/16"

Code	Size (Width)	List/ea
6541-13-5	13"	\$ 18.82
6541-14-5	14-1/4"	19.06
6541-16-5	16"	19.06
6541-19-5	19"	20.43
6541-22-5	22"	22.05
6541-25-5	25"	23.90
6541-28-5	28"	25.26
6541-31-5	31"	26.87

### HINGES FOR SINK FRONT TRAYS

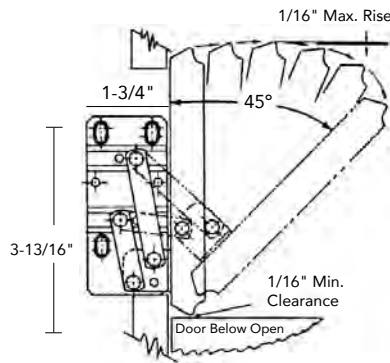

Unique self-closing spring to keep false fronts securely closed

Patented hinges allow the panel to pull out and tip open for full accessibility. Less than 2mm needed for tight clearance of full overlay doors. Hinges mount easily to frame and frameless construction and offer concealed and self-closing features.

Code	Dimensions	Ctn	List/pr
6552-95-0220	1" W x 1-3/4" D x 3-13/16" H	40 pr	\$ 6.80

### SOFT CLOSE HINGES FOR SINK FRONT TRAYS

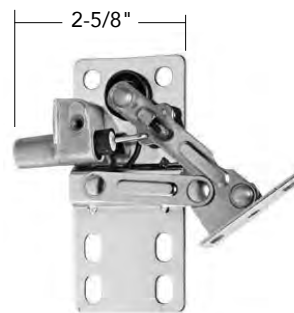

LD-0220-50SC  
 Soft Close

- Works with all Rev-A-Shelf tip-out trays
- Soft-close piston eliminates slamming
- The 50° opening allows complete access
- Spring for self close and stay close action
- Stiffening ribs eliminate side play
- Nickel finish

Code	Dimensions	Ctn	List/pr
LD-0220-50SC	1" W x 2-5/8" D x 3-7/8" H	5 pr	\$ 25.26



## SINK FRONT TRAYS

### REV-A-SHELF POLYMER SINK FRONT TRAYS



Available in white or almond.

Depth: 2-1/8" overall.  
 Back Height: 3-13/16".

**Polymer Trays WITHOUT Hinges** Pack: 40 ea/Ctn.  
 Sold per each.

Code	Size	Color	List/ea
6581-11-11-4	11"	White	\$ 5.96
6581-14-11-4	14"	White	5.96
6581-14-15-4	14"	Almond	6.56

### REV-A-SHELF POLYMER TRAYS WITH TAB STOPS

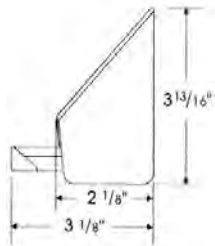

Tabs are engineered to resist twice the force of other trays with tab stops before breaking. Designed for use with standard self-closing hinges used in most cabinetry. Sold per each.

Code	Description	Ctn	List/ea
6561-14-11-4	14", White w/ Stops	40 ea	\$ 6.19

### 6572 SERIES SINK FRONT 2 TRAY SET

One Standard Tray / One Accessory Tray

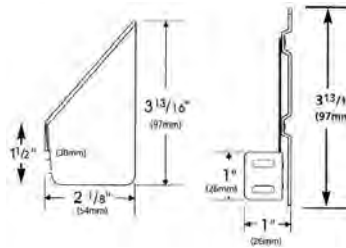
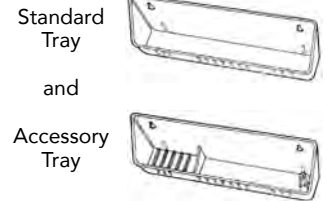

Two pairs of hinges included



Accessory Tray includes Ring Post

The 6572 Series includes one conventional open tray, one accessory tray with ring holder and soap dish and two pairs of hinges. Made of high-impact polystyrene. White in color. 1 set/bx.

Depth: 2-1/8". Back Height: 3-13/16".

Code	Description	Ctn	List/st
6572-11-11-52	White, 11" Wide	1 set	\$ 29.85
6572-14-11-52	White, 14" Wide	1 set	30.10

### EURO-TRAY HINGE FOR LONG FALSE FRONTS

6552-ETH-10

The Euro hinge is designed for long sink front or cooktop false panels in frameless or framed cabinet applications. The opening can be adjusted from 45° to 90°. Chrome plating allows for installation in any application.

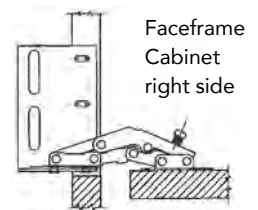
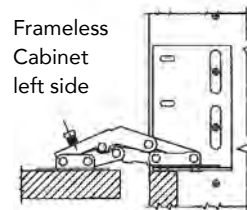

Code	Description	Ctn	List/pr
6552-ETH-10	Euro-TRAY hinge	10 pr.	\$ 16.11

## SINK FRONT TRAYS



### REV-A-SHELF SLIM SERIES

Sink front trays for Minimum clearance applications



The Slim Series polymer trays are designed to fit solid surface countertop and large sink applications. 36" trays can be cut to size. One pair of hinges and end caps are included. White finish. Available soft close.

36" W x 1-11/16" D x 3-15/16" H

Code	Description	Ctn	List/ea
6541-36-11-50	White Tray, End Caps, 1 pr. hinges	1 set	\$ 29.35
6541-36SC-11-50	White Tray, End Caps, 1 pr. Soft Close hinges	1 set	39.75



#### 36" Trays Only:

Code	Ctn	List/ea
6541-36-11-4	20 ea	\$ 16.23

### HINGES AND END CAPS

For Slim Trays

Two hinges and two end caps per bag. Use with the 6541-36 Slim Trays shown above.



Code	Description	Ctn	List/bg
6542-97-11-4	Hinges/End Caps	40 bgs	\$ 16.23

### REV-A-SHELF SINK FRONT TRAYS

36" or 72" - Cut To Size!

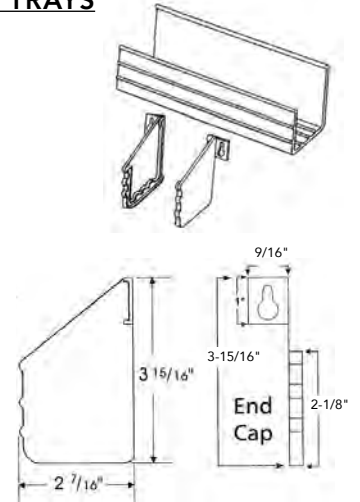

Cut to size sink front trays in 3' or 6' lengths.  
 Depth: 2-7/16".  
 Back Height: 3-15/16".

#### 36" Lengths - Single Pack

Packed one set per box. Each set includes 1 ea. 36" tray, 2 pr. hinges and 2 pr. end caps.

Code	Size	Color	List/st
6551-36-11-52	36"	White	\$ 44.83
6551-36-15-52	36"	Almond	44.83

#### 36" Lengths - Bulk Pack

20 sets per carton. Each set includes 1 ea. 36" tray, 1 pr. hinges and 1 pr. end caps. Trays individually polybagged. Sold in full cartons only.

Code	Size	Color	List/st
6551-36-11-599	36"	White	\$ 29.73

#### 72" Lengths - Bulk Pack

20 ea. 72" trays per carton. Hinges and endcaps must be ordered separately.

Code	Size	Color	List/ea
6571-72-11-4	72"	White	\$ 37.23

### HINGES AND END CAPS

Two hinges, two endcaps and a packet of glue per polybag.



Code	Color	Ctn	List/bg
6552-97-11-4	White	40 bgs	\$ 14.50

## SINK FRONT TRAYS

### HINGES ONLY for Sink Front Trays



Code	Ctn	List/pr
6552-95-0220	40 pr	\$ 6.80

### END CAPS/SCREWS ONLY



Code	Color	Ctn	List/pr
ST-97-11-4	White	40 pr	\$ 8.30
ST-97-15-4	Almond	40	8.30

### GLUE ONLY

2 Grams Adhesive



Code	Ctn	List/ea
6571-60	10	\$ 5.92

### CABINET VENTILATING LOUVERS

Washington Products

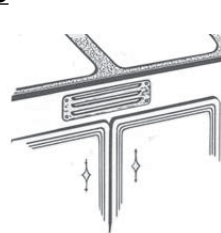

For apron above sink door. Outside dimensions: 10-7/16" x 2-7/8". Cut-Out dimensions: 9" x 2-1/2". 12 per box.

Code	Finish	List/ea
12-26	Bright Chrome	\$ 19.47

## IN-DRAWER OUTLETS

### VANITY OUTLET DRAWER

4VOD Series



- Designed for 18" base cabinet drawers
- (2) compartments, (2) stainless steel bins
- Full extension, 100 lbs, Soft-Close slides
- Includes mounting brackets for drawer front (drawer front not included)

Make the mess of a cluttered vanity a thing of the past with this vanity outlet drawer. Store hair dryers and curling irons in one easy-to-access location and additional compartments are perfect for organizing beauty products. With the integrated outlet you always have a free receptacle to plug items in.

Dimensions:

15" W x 20-1/8" D x 8-15/16" H



Code	Description	MCO	List/ea
4VOD-18SC-1	Vanity Outlet Drawer	15"	\$ 563.97

### DOCKING DRAWER

In Drawer Outlets, 4 AC, 15 amp

One size for any drawer type, this outlet safely plugs directly into the wall. Features an interlocking thermostat that de-energizes the outlet when the surrounding temperature exceeds 120°.



**4AC:**  
 15 amps  
 @ 120 VAC



	Code	Finish	List/ea
○ White	1514-266W	White	\$ 440
● Black	1514-266B	Black	440
● St Steel	1514-266S	St. Steel	440

\* See more Docking Drawer Outlets next two pages

## IN-DRAWER OUTLETS

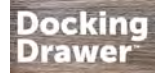

### DOCKING DRAWER

USB Charge and AC Power in one outlet plate

Blade Series In Drawer Outlets offer both 5 V DC charge AND 120 V AC power in a single solution. One size for any drawer type, this outlet safely plugs directly into the wall. Features an interlocking thermostat that de-energizes the outlet when the surrounding temperature exceeds 120°. Available in White, Black and Stainless Steel.

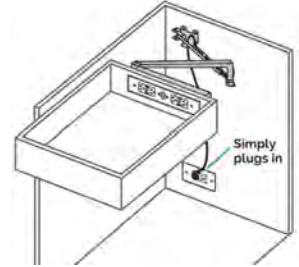
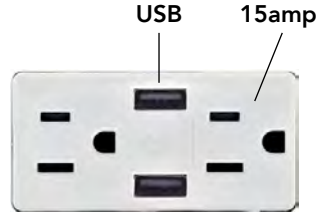

Electrical Connection

### 15 amp Blade In Drawer Outlet



- White
- Black
- Stainless Steel



1514-110W

### 15 amp Blade Duo In Drawer Outlet



- White
- Black
- Stainless Steel



1514-232S

**Cabinet Depth:** ≤ 24"

**Min Drawer Box width:** ≥ 15"

**Min space behind drawer box:** 2"

**Min Interior drawer box height:** 3"

**Cabinet Depth:** ≤ 24"

**Min Drawer Box width:** ≥ 15"

**Min space behind drawer box:** 2"

**Min Interior drawer box height:** 3"

### 2AC & 2 USB-A

AC: 15 amps @ 120 VAC  
 USB-A: 3.6 amps @ 5 VDC

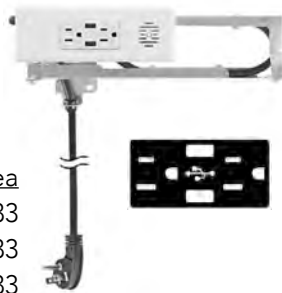

Code	Finish	List/ea
1514-110W	White	\$ 398.33
1514-110B	Black	398.33
1514-110S	St. Steel	398.33

### 2AC, 2 USB-C & 4 USB-A

AC: 15 amps @ 120 VAC  
 USB-A: 3.6 amps @ 5 VDC  
 USB-C: 3 amps\*

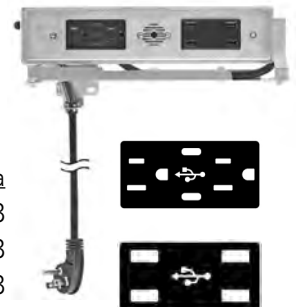

Code	Finish	List/ea
1514-232W	White	\$ 598.33
1514-232B	Black	598.33
1514-232S	St. Steel	598.33

\*varies depending upon devices connected.

### Style Drawer Canisters

Stainless Steel

Create the perfect Styling Station with the Style Drawer Canister. Closed bottom; fits any style blow dryer. This holder is made to fit into your salon styling station so that you can store hot appliances even while they are in use.



Diameter: 5.25",  
 Length: 6.5"

Code 0024-00005 List/ea \$ 45



## DOCKING DRAWER

### DOCKING DRAWER

20 amp Blade In Drawer Outlet



20 amps @  
 120 VAC

- White
- Black
- Stainless Steel



2012-160B

This Blade Series In Drawer Outlet requires a 20 amp wall receptacle with T-shaped prongs for the NEMA 5-20P plug. Features 3' long heavy-duty 12 AWG\* power cord with NEMA 5-20P plug and 20 amp receptacles.

Perfect for bathrooms, commercial applications and any other use case requiring 20 amps. Requires a 20 amp wall plug. ETL Listed for use in the US and Canada. Features an interlocking thermostat that de-energizes the outlet when the surrounding temperature exceeds 120°. Available in White, Black and Stainless Steel.



**Cabinet Depth:** ≤ 24"

**Min Drawer Box width:** ≥ 15"

**Min space behind drawer box:** 2"

**Min Interior drawer box height:** 3"

#### 2AC:

AC: 20 amps @ 120 VAC

Code	Finish	List/ea
2012-160W	White	\$ 398.33
2012-160B	Black	398.33
2012-160S	St. Steel	398.33

\* #12 American Wire Gauge



### MAPLE CHARGING DRAWER



Complete System for Electronics to Replace Existing Drawers



Charge all your electronics together in one complete drawer system with Rev-A-Shelf's 4WCDB Series Charging Drawer. Featuring maple construction with shock absorbent mat and soft-close slides, this easy-to-install unit is designed for 18" base cabinets and boasts an integrated cord guide to ensure safe operation and an in-drawer receptacle with two UL safety listed 120V plugs and 2.1 amp USB ports. Drawer front not included.

- Maple construction with semi-gloss finish
- Complete drawer system, just add your drawer front
- Designed for face frame 18" base cabinet drawers
- Includes door mounting brackets
- Easy installation: mounts to cabinet side and rear wall
- Full-extension, soft close undermount slides
- In-drawer receptacle with two 120V plugs and two 2.1 amp USB ports
- Includes power cord with NEMA 5 - 15 plug
- Integrated cord guide to ensure safe operation
- Max Current: AC: 12 amps @ 120VAC; USB 2.1 amp & 5VDC



**Dimensions:**  
 15" W x 22-3/4" D x 4-5/16" H

Code	Description	MCO	List/ea
4WCDB-18HSC-1	Maple Charging Drawer	15"	\$ 516.32





## DRAWER DIVIDERS



### DRAWER PEG SYSTEM

4DPS Series



4DPS-3921

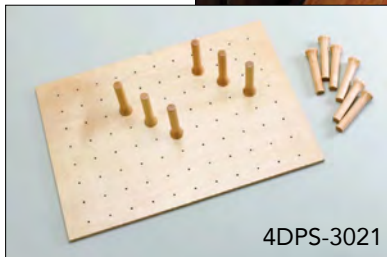

4DPS-3021

Create instant storage for organizing all kinds of items, from dinner plates to plastic containers with dividers for your drawers. The 4DPS board can be trimmed to size and is available in three sizes to fit cabinets from 36", 39" and 42" (4DPS-3921), 30" and 33" cabinets (4DPS-3021) and 27" and smaller (4DPS-2421).

The width of the board is maximized to fit the largest cabinet drawers with undermount slides, is constructed from UV-Cured maple and comes with matching, push-in pegs. Peg Board only available Special Order (4DPB) - Call for price.

#### Small Drawer Peg System (9 Pegs)

Code	Dimensions	List/st
4DPS-2421	24-1/4"W x 21-1/4"D x 6-5/8"H	\$ 131.10

#### Medium Drawer Peg System (12 Pegs)

4DPS-3021	30-1/4"W x 21-1/4"D x 6-5/8"H	146.24
-----------	-------------------------------	--------

#### Large Drawer Peg System (16 Pegs)

4DPS-3921	39-1/4"W x 21-1/4"D x 6-5/8"H	188.67
-----------	-------------------------------	--------

#### Additional Pegs - Must order in increments of 4

Code	Description	List/each peg
4DPSPEG-4	4 ea. pegs/box	\$ 9.28

### POT/PAN & LID ORGANIZER FOR DRAWERS

For Drawer Pegboards



Easy Press-in installation

Designed for use with 4DPS Pegboards



#### 5DCD-1-CR Pot/Pan Organizer - Adjustable

Pot and pan rack for deep drawers. Chrome rack features complete adjustability to keep multiple sizes of cookware organized.

Created to use in combination with 5DLD-1-CR lid organizer, the rack holds up to five pots and pans and features a trimmable handle rest.

7-3/4"W x 15-1/4"D x 7-5/8" H



#### 5DLD-1-CR Lid Organizer

Chrome lid organizer for deep drawers. Designed to work with the 4DPS peg board, this easy press-in rack keeps up to six lids organized, in reach, and when used in combination with our 5DCD-1-CR pot and pan holder you have a complete cooking station at your fingertips.

5-1/4"W x 16-7/8"D x 5-3/8" H



Organizers designed for use with these peg boards:

- 4DPS (Peg board system)
- 4DPB (Wood Peg board only - Special Order)
- 4DPBG (Vinyl Peg Board only - Special Order)

Code	Description	List/ea
5DCD-1-CR	Chrome Adjustable Pot/Pan Organizer for drawer pegboards	\$ 40.39
5DLD-1-CR	Chrome Lid Organizer for drawer pegboards	30.10



### CUTLERY TRAYS

#### TRIMMABLE KNIFE BLOCK INSERT



**4WKB-1**  
18-1/2" W x 22" D  
x 2-3/8" H

Knife Block Tray Insert has 19 slots to store knives and a separate compartment for other utensils. Simple drop-in installation. Natural maple construction with semi-gloss finish. Can be trimmed to fit drawers of various widths and lengths. Designed for 18-1/2" or smaller base cabinet drawers. Compatible with 4WD-22 wood divider when using multiple inserts.

Code	Description	List/ea
4WKB-1	Trimmable Wood Knife Block	\$ 118.89

#### TRIMMABLE DOUBLE KNIFE BLOCK INSERT



**4WDKB-1**  
• 55 Knife slots

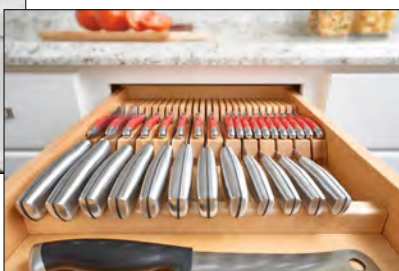

- Additional storage compartments for cleavers and utensils
- Trim to Fit: designed for drawers from 12-1/2" to 18-1/2" in width
- Hilt rest that keeps knives straight and provides ample finger space for easy removal

Product Dims: 18-1/2" W x 22" D x 2" H

Code	Description	List/ea
4WDKB-1	Trimmable Wood Double Knife Block Insert	\$ 145.40

#### WOOD CUTLERY TRAY INSERT



4WCT-1

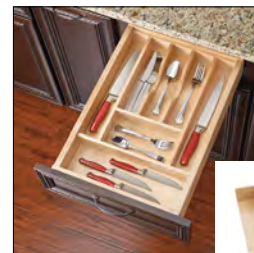

4WCT-1SH  
Shallow Height: 2-3/8"



- Natural maple construction with semi-gloss finish
- Simple Drop-in Installation
- Available in two widths that may be trimmed to fit various drawer sizes
- Shallow height sizes available
- Compatible with 4WD-22 wood divider when using multiple inserts.

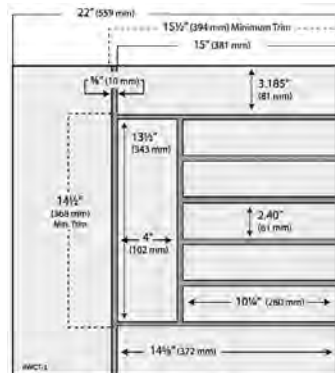

4WCT-3

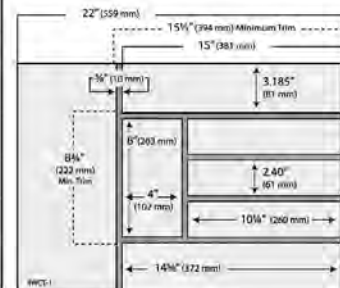

4WCT-1

Code	Size	List/ea
4WCT-1	14-5/8" W x 22" D x 2-7/8" H trimmable to 8-3/4" W x 15-1/2" D	\$ 79.52
4WCT-3	20-5/8" W x 22" D x 2-7/8" H trimmable to 14-1/4" W x 15-1/2" D	109.74
4WCT-1SH	14-5/8" W x 22" D x 2-3/8" H trimmable to 8-3/4" W x 15-1/2" D	73.08
4WCT-3SH	20-5/8" W x 22" D x 2-3/8" H trimmable to 14-1/4" W x 15-1/2" D	94.12

## DRAWER INSERTS

### WOOD UTILITY TRAY INSERT



4WUT-3SH

- Natural maple construction with semi-gloss finish
- Simple Drop-in Installation
- Available in two widths that may be trimmed to fit various drawer sizes
- Shallow height sizes available
- Compatible with 4WD-22 wood divider when using multiple inserts.



4WUT-1

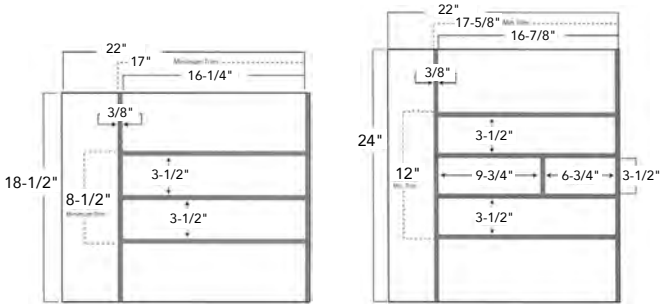

4WUT-1

4WUT-3

### Wide Drawer Insert:

Utility Drawer Insert designed for 36" or smaller base cabinet drawers. Natural maple construction features 11 large storage compartments.



4WUT-36-1

Code	Size	List/ea
4WUT-1	18-1/2" W x 22" D x 2-7/8" H	\$ 83.37
4WUT-3	24" W x 22" D x 2-7/8" H	106.13
4WUT-1SH	18-1/2" W x 22" D x 2-3/8" H	84.09
4WUT-3SH	24" W x 22" D x 2-3/8" H	102.53
4WUT-36-1	33-1/8"W x 19-3/4"D x 2-7/8"H	184.05

### WIDE COMBINATION DRAWER INSERTS

These trim-to-fit inserts are now designed for 33"- 36" base cabinet drawers. Constructed of natural maple with a semi-gloss finish. Simple drop-in installation. Some compartments are adjustable.



4WUTKB-36-1



Features ample space for your utensils, cutlery and knives with up to four static and two adjustable storage compartments, and fifteen knife slots.

Product Dims: 33-1/8" W x 19-3/4" D x 2-7/8" H



4WUTCT-36-1

Combination Utensil and Cutlery Drawer Insert features ample space for your utensils and cutlery with up to ten static and two adjustable storage compartments.

Product Dims: 33-1/8" W x 19-3/4" D x 2-7/8" H

Code	Description	List/ea
4WUTKB-36-1	Combination Utensil/ Knife Drawer Insert	\$ 238.80
4WUTCT-36-1	Combination Utensil/ Cutlery Drawer Insert	195.05



## CUTLERY DRAWERS

### TWO TIERED CUTLERY DRAWERS

4WTCD Series



For base cabinet drawers 15" - 24".

4WTCD-18



- Natural maple construction with semi-gloss finish
- Mounts to cabinet drawer front, rear and side walls

This unique design provides two tiers for double the storage capacity in a pre-assembled drawer box. For use with 3/4" material undermounts (i.e. Dynapro DP-34-21). Designed for typical 1-1/2" Face Frame Construction only. Complete drawer system - just add your drawer front!

#### Face Frame, w/ Soft Close Slides

All 21-3/4" Depth, 4-5/16" Height

Code	Description	Width & MCO*	List/ea
4WTCD-15HSC-1	For 15" Cabinet	12"	\$ 232.53
4WTCD-18HSC-1	For 18" Cabinet	15"	271.43
4WTCD-21HSC-1	For 21" Cabinet	18"	273.08
4WTCD-24HSC-1	For 24" Cabinet	21"	292.91

\*Minimum Cabinet Opening

#### Face Frame, No Slides All 21" Depth, 3-3/4" Height

Code	Description	Width	List/ea
4WTCD-15H-1	For 15" Cabinet	11-1/2"	\$ 172.15
4WTCD-18H-1	For 18" Cabinet	14-1/2"	205.21
4WTCD-21H-1	For 21" Cabinet	17-1/2"	229.11
4WTCD-24H-1	For 24" Cabinet	20-1/2"	241.51

### TIERED COMBINATION CUTLERY DRAWERS

4WTCD Series



4WTCD-30



For Wide drawers 30" and 36"

Shares the same features as the 4WTCD models in the previous column, but also includes a movable upper cutlery tray that conceals a built-in knife organizer. Adjacent compartments provide ample storage.

#### Full Access w/ Soft Close slides

Dims: 28-1/2" W x 22-3/16" D x 4-7/16" H

Code	MCO	List/ea
4WTCD-724HFLSC-1	28-1/2"	\$ 491.72

#### Face Frame, No Slides All 21" Depth, 3-3/4" Height

Code	Description	Width	List/ea
4WTCD-30H-1	For 30" Cabinet	26-1/2"	\$ 288.72
4WTCD-36H-1	For 36" Cabinet	32-1/2"	332.54

#### Face Frame, w/ Soft Close Slides

All 22-1/4" Depth, 4-5/16" Height

Code	Description	Width & MCO*	List/ea
4WTCD-30HSC-1	For 30" Cabinet	27"	\$ 464.43
4WTCD-36HSC-1	For 36" Cabinet	33"	508.37

### WOOD DIVIDER

4WD Series

Wood Divider  
4WD-22

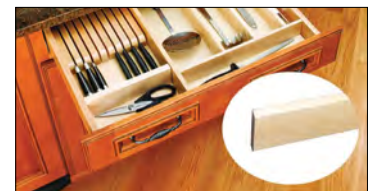

Allows you to combine various drawer inserts for easy organization of utensils and silverware. Use with 4WCT, 4WUT, 4WKB and 4SDI Series inserts. Made of maple hardwood with a UV-Cured clear finish. Trim to fit.

Code	Dimensions	List/ea
4WD-22	1/2" W x 22" D x 2-7/8" H	\$ 13.63



## DRAWER INSERTS



### REV-A-SHELF UTILITY TRAYS



- Available in 3 styles and 3 sizes
- Made of high impact rubberized textured polystyrene
- Easy trimming to fit cabinet drawer size
- Height: 2-3/8"

**UT10**

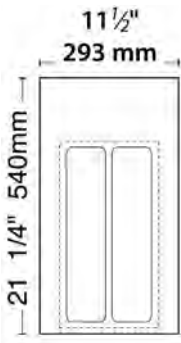

Min. Trim Size  
8-5/8" x 17-3/4"

**UT15**

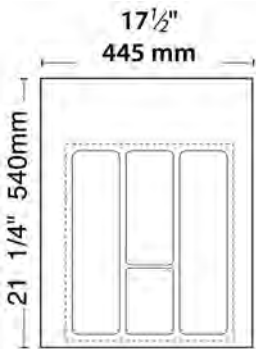

Min. Trim Size  
14-3/4" x 17-3/4"

**UT18**



Min. Trim Size  
18-3/8" x 17-3/4"

### REV-A-SHELF CUTLERY TRAYS



- Available in 4 styles and 4 sizes
- Made of high impact rubberized textured polystyrene
- Easy trimming to fit cabinet drawer size
- Height: 2-3/8"

**CT1**

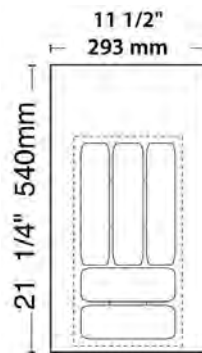

Min. Trim Size  
8-5/8" x 17-3/4"

**CT2**

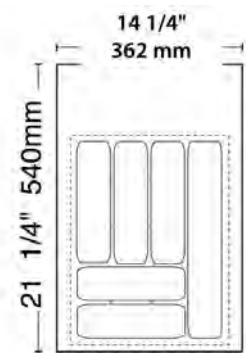

Min. Trim Size  
11-5/8" x 17-3/4"

**CT3**

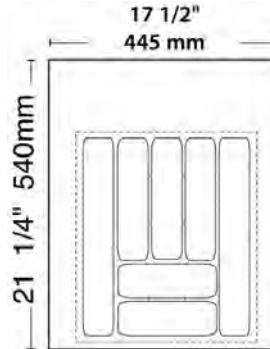

Min. Trim Size  
14-3/4" x 17-3/4"

**CT4**

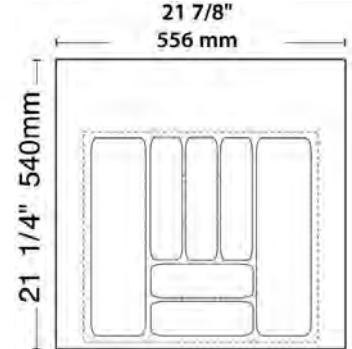

Min. Trim Size  
18-3/8" x 17-3/4"

### WHITE UTILITY TRAYS Height: 2-3/8"

Code	Max. Size	List/ea
UT10WH	11-1/2" W x 21-1/4" D	\$ 26.63
UT15WH	17-1/2" W x 21-1/4" D	29.11
UT18WH	21-7/8" W x 21-1/4" D	40.67

### WHITE CUTLERY TRAYS Height: 2-3/8"

Code	Max. Size	List/ea
CT1WH	11-1/2" W x 21-1/4" D	\$ 21.34
CT2WH	14-1/4" W x 21-1/4" D	29.94
CT3WH	17-1/2" W x 21-1/4" D	33.73
CT4WH	21-7/8" W x 21-1/4" D	38.50



## SPICE TRAYS

### WOOD SPICE DRAWER INSERT



4SDI-24

Compatible with 4WD-22 wood divider (see page ) when using multiple inserts.



4SDI-36-1

With a tiered configuration for total organization and easy access, these natural maple spice drawer inserts can be customized to fit various drawer sizes up to a Base 36". Simple drop-in installation.

Code	Dimensions	List/ea
4SDI-24	22"W x 19-3/4"D x 1-1/2"H	\$ 119.25
4SDI-36-1	33-1/8"W x 19-3/4"D x 1-3/4"H	174.89

### REV-A-SHELF SPICE TRAYS



ST50-21

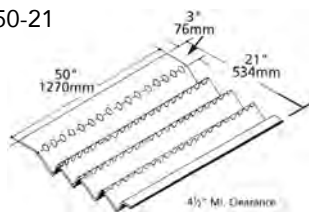

22" drawer slides are required to fully expose and access this tray. Minimum vertical clearance for use with standard 4" spice bottles is 3-1/2". High impact polystyrene is trimmable to any size.

Code	Description	List/ea
ST50-21WH	White Tray, 50" W x 21" D	\$ 72.03
ST50-21AL	Almond Tray, 50" W x 21" D	72.08

## SPICE RACKS

### DOOR MOUNT SPICE RACK



565 Series

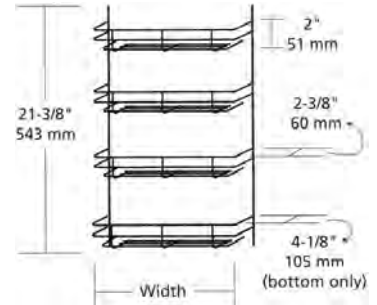

Features 3 small tiers to hold spices and one larger tier that can accommodate canned goods. Heavy gauge wire construction - installs with just 4 screws. White in color.

Code	Dimensions	MCO	List/ea
565-10-52	10-5/8" W x 21-3/8" H	12"	\$ 51.27



## SPICE RACKS

### DOOR MOUNT SPICE RACK

4SR Series

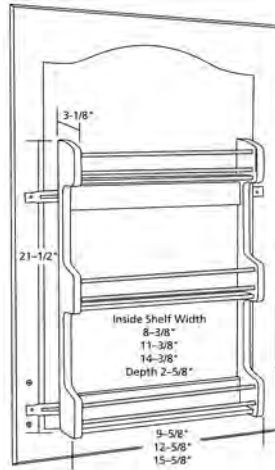

- Can house spice bottles up to 2-1/4" in diameter
- Installs with just four screws (included)



Made of birch/maple hardwood with a UV-cured clear coat finish. Contains 3 shelves, chrome rails and adjustable mounting brackets. Height between racks: 8-5/8".

For 15" Wall Cabinet / Inside Rack: 8-3/8"W x 2-5/8"D

Code	Width x Depth x Height	MCO	List/st
4SR-15	10-1/2" x 3-1/8" x 21-1/4"	11-1/2"	\$ 80.61

16 For 18" Wall Cabinet / Inside Rack: 11-3/8"W x 2-5/8"D

4SR-18	13-1/2" x 3-1/8" x 21-1/4"	14-1/2"	91.16
--------	----------------------------	---------	-------

For 21" Wall Cabinet / Inside Rack: 14-3/8"W x 2-5/8"D

4SR-21	16-1/2" x 3-1/8" x 21-1/4"	17-1/2"	99.79
--------	----------------------------	---------	-------

### ADJUSTABLE DOOR MOUNT SPICE RACK

4ASR Series

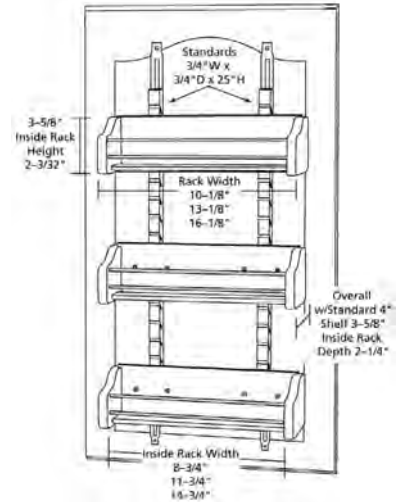

BRACKET ON BACK OF SHELF FOR ATTACHING TO STANDARDS



Maple hardwood rack is available for 15", 18" and 21" wall cabinets. Features adjustable shelves, UV-cured clear coat finish and shelf space to house spice bottles up to 2-1/4" in diameter. Brackets offer up to an extra 5" of mounting adjustability and designed to extend mounting options to the thick portion of the door increasing installation flexibility. Installs with just four screws.

Each set contains 3 Shelves, 2 ea. 25" slotted standards and brackets, and screws.

For 15" Wall Cabinet / Inside Rack: 8-3/4"W x 2-1/4"D

Code	Width x Depth x Height	MCO	List/st
4ASR-15	10-1/8" x 4" x 25"	12"	\$ 112.09

For 18" Wall Cabinet / Inside Rack: 11-3/4"W x 2-1/4"D

4ASR-18	13-1/8" x 4" x 25"	15"	138.35
---------	--------------------	-----	--------

For 21" Wall Cabinet / Inside Rack: 14-3/4"W x 2-1/4"D

4ASR-21	16-1/8" x 4" x 25"	18"	164.47
---------	--------------------	-----	--------



## SPICE RACKS

### DROP OUT CABINET FIXTURES

**Special Order**

#### 8001 - Spice Rack Storage System



Unparalleled convenience and space-saving efficiency at your fingertips!

Min. Depth: 11-1/2"

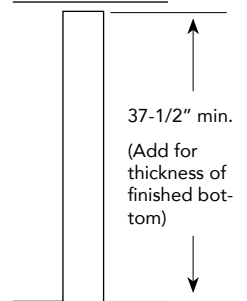

Frees up traditional spice storage spaces, such as drawers and shelves, for other kitchen essentials.

4"  
Front View

- Four inches wide, it opens with a smooth outward and downward motion, bringing the spice rack down to you.
- Brings up to 36 standard-sized spice bottles to your fingertips, all perfectly organized and ready for use - no fuss, and no mess.
- Can be integrated into any style of cabinetry, making it versatile for most any design. Can also be used for other storage needs.

### Spice Rack Storage System Accessories



#### **8006K** **K-Cup Rack**

32 Slot  
Capacity

#### **8005B** **Spice Bottles 12 pack**

Includes shaker insert  
and black cap



<u>Code</u>	<u>Description</u>	<u>List</u>
8001	Spice Rack Storage System	\$ 1347
8006K	K-Cup Rack for Storage System	92
8005B	Spice Bottles for Spice Rack (12 pack)	63





## HAMPERS

### REV-A-SHELF PULL-OUT WIRE HAMPERS

HRV Series

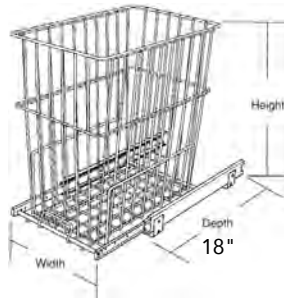

Removable wire hamper with frame and full extension slides. Installs with just four screws. White finish. For door mount, order with RV-DM KIT.

Code	Min. Cabinet Opening	List
HRV1215S	11-3/4"W x 18-1/4"D x 14-7/8"H	\$ 190.60
HRV1220S	11-3/4"W x 18-1/4"D x 14-7/8"H	191.47
HRV1515S	14-3/4"W x 18-1/4"D x 19-1/2"H	194.81
HRV1520S	14-3/4"W x 18-1/4"D x 19-1/2"H	208.68

### Chrome Wire Version

Furnished with Liner.  
 18" Depth.



HRV1520SCR

Code	Min. Cabinet Opening	List
HRV1520SCR	14-3/4"W x 18-1/4"D x 19-1/2"H	\$ 222.55

### Replacement Liners

Code	Description	List
HRV-1520-LINER	Liner for HRV Series Hamper	\$ 47.69

### REV-A SHELF SLIDE-OUT POLYMER HAMPER

20" Depth For Vanity applications

1.5 Bushel (55.8 qt) capacity in this easily removable hamper. For door mount, order with RV-DM KIT.

Contains 1 polymer hamper with frame and full extension slides. Fully assembled.

14-1/4" W x 20" D x 19-3/8" H



Code	Description	MCO	List
HPRV-1520S	Slide-out Hamper	15"	\$ 137.48

### REV-A SHELF SLIDE-OUT POLYMER HAMPER

14" Depth For Closet applications

2.3 Bushel (63 qt) capacity in this easily removable hamper. Includes detachable lid. Available with or without door mount bracket kit.

Contains 1 polymer hamper with frame and full extension slides. Fully assembled.

Dimensions:  
 19-7/8"W x 14"D x 24"H



HPRV-1925DMS

Code	Description	MCO	List
HPRV1925S	Slide-out hamper	20"	\$ 196.67
HPRV-1925DMS	Slide-out hamper w/ Door mount brackets	20"	238.40

MCO = Minimum Cabinet Opening



## HAMPERS

### TILT-OUT HAMPER BASKET

CTOHB Series



Door mount the basket to a bottom hinged cabinet for easy one step "Slide-In/Slide-Out" basket removal. Available in Chrome, Satin Nickel and Oil Rubbed Bronze. Durable 6.6mm wire has a capacity of 55 qts for the 16" wide unit and 74 qts for the 21" wide unit. All models 13-1/2"D and 19-3/4"H.

Code	Width	Finish	MCO	List
CTOHB-161319-CR	15.5"	Chrome	16.5"	\$ 136.88
CTOHB-211319-CR	20.5"	Chrome	21.5"	163.83
CTOHB-161319-SN	15.5"	Sat Nickel	16.5"	129.17
CTOHB-211319-SN	20.5"	Sat Nickel	21.5"	141.87
CTOHB-161319-ORB	15.5"	Oil R Brz	16.5"	129.17
CTOHB-211319-ORB	20.5"	Oil R Brz	21.5"	138.71

### Removable Hamper Bags for CTOHB Baskets

Machine washable Black or Tan Cloth Liners. Designed to fit tight and securely with hook and loop fasteners. Strong handles for easy transport and removal.



Code	Description	List/ea
CTOHB-16-I-1	Black Liner for 16" Basket	\$ 58.95
CTOHB-21-I-1	Black Liner for 21" Basket	75.43
CTOHT-16-I-1	Tan Liner for 16" Basket	72.94
CTOHT-21-I-1	Tan Liner for 21" Basket	76.90



### Flap Stay for Slanted Hampers

Perfect for hamper doors that need more swing control, the flap stay hardware fastens to both the inside and the adjacent vertical section panel. Polished Chrome finish.

Code	Description	List/ea
CTOHBSL-FS-1	Flap Stay for Hamper	\$ 28.49

### WIRE HAMPER WITH SOFT-CLOSE SLIDES

CH Series



5CHB-LINER  
(Sold Separately)

CH-241419-RM-217

- Two removable wire baskets and machine washable cloth liners.
- Silver polymer base
- Bottom mount full extension slides
- Soft-Open/Soft Close Rev-A-Motion™ technology
- Simple four screw installation
- Includes door mount brackets



24" W x 13-15/16" D x 18-7/8" H MCO: 24"

Code	Description	List
CH-241419-RM-217	Double Wire Hamper w/ 2 Canvas Liners	\$ 636.63
5CHB-LINER	Replacement Liners	27.48

### BOTTOM MOUNT WOOD HAMPER 4WH Series



Rev-A-Motion slide system provides 7" of assisted opening and closing.

4WH-RM15DM1

This Soft Open/Soft Close hamper features built-in door mount brackets and a concealed 150 lb. slide. The gas spring assisted Soft-Open allows the unit to open smoothly, and the Soft-Close shuts it softly, even under the heaviest of loads. Maple base with a white hamper basket and lid. Ideal for vanities and closets.

14-1/4" W x 19-3/4" D x 21" H

Code	Min Cabinet Opening	List
4WH-RM15DM1	14.5"W x 19-7/8"D x 21.25"H	\$ 441.81





## HAMPERS



### **BOTTOM MOUNT WOOD HAMPER**

4WH Series for Vanity



- Designed for face frame 24" vanity base cabinets
- Includes Single 1.5 BU (about 56 Qts) white polymer hamper and lid
- Maple frame with semi-gloss finish
- Full extension, 110 lb, soft-close concealed slides
- Pre-assembled door mount brackets

4WH-VCSC-21DM-1

A single 1.5 BU polymer hamper rests in a maple frame with semi-gloss finish and glides on full-extension, 110 lb. rated, concealed soft close slides. Comes complete with rear storage space, one matching lid and pre-assembled door mount brackets.

Dimensions: 20-5/16" W x 18-11/16" D x 21-1/4" H      MCO: 21" W

<u>Code</u>	<u>Description</u>	<u>List/ea</u>
4WH-VCSC-21DM-1	Bottom Mount Hamper, Single white bin and lid	\$ 404.88

### **BOTTOM MOUNT WOOD HAMPER**

4WHOX Series with Extra Storage Compartment

- Soft-close slides
- For 24" full height base cabinets
- Maple dovetail construction with a semi-gloss finish
- Door mount brackets provide 5" of adjustability



**Includes:** (1) storage compartment, (1) 1.3-bushel hamper and (1) 1.7 qt. container

Dimensions: 21" W x 22" D x 19-15/16" H      MCO: 21" W

<u>Code</u>	<u>Description</u>	<u>List/ea</u>
4WHOX-24DMSC-1	Bottom Mount Hamper, Single white bin and lid, w/ storage & accessories	\$ 536.00

### **PULL-OUT CANVAS HAMPER**

5190 Series



- Rev-A-Motion Soft-Open/Soft Close system
- 7" of assisted opening and closing
- Designed for base 18 vanity cabinets
- Easy installation with only 4 screws



Pull-out hamper features a brushed aluminum frame with Rev-A-Motion Soft-Open/Soft-Close technology.

Removable cloth bag and adjustable door mount brackets.

Dimensions: 14-5/16" W x 18-1/16" D x 19-11/32" H      MCO: 14-1/2" W

<u>Code</u>	<u>Description</u>	<u>List</u>
5190-15RM-117	Cloth Hamper w/ Silver Tray	\$ 490.43

### **WOOD DRYING RACK DRAWER**

4WDR Series

This drying solution installs into your existing cabinet; you only need to attach your drawer front. Rack is easy to access and use. Unfold the arms for up to 18 linear ft. of drying space.



4WDR-24HSC-1  
Drawer front not included

Two positions of placement to flat or hang dry items on rust-resistant stainless steel rods.

- Soft-close slides
- Load cap: 90 lbs.
- Maple construction with semi-gloss finish



Dimensions: 21" W x 22" D x 4-13/32" H      MCO: 21" W

<u>Code</u>	<u>Description</u>	<u>List</u>
4WDR-24HSC-1	Wood Drying Rack	\$ 292.00

## IRONING BOARDS

### PULLOUT IRONING BOARD



VIB-20CR



Expandable frame mounts easily in a drawer between cabinet sides from 14-1/4" to 21" wide and the fixed brackets allow for easy mounting of all standard drawer fronts. Features a chrome finish and a ball-bearing slide system that provides sufficient overtravel for maximum utilization. Simply open until the gravity lock engages, unfold board and you are ready to iron.

Height Clearance: 4"  
 Min. Cab. Depth: 20-1/4"  
 Min. Drawer Height: 4"  
 Min. Cab. Opening: 14-1/4" to 21"  
 Mounts in frame or frameless cabinets.  
 Board Size: 12" W x 37-1/2" L

**\*Max Countertop Projection: 1-1/4"**

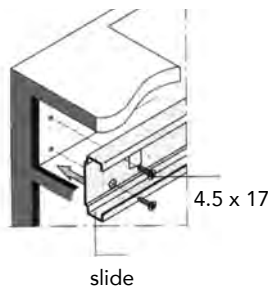
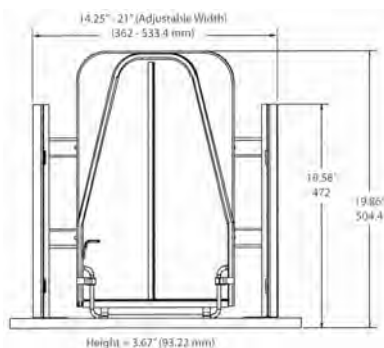

Code	Description	List/ea
VIB-20CR	Fold Out Ironing Board for Vanity Cabinets	\$ 336.88

### FOLD OUT IRONING BOARD

CIB Series



CIB-16CR

The expandable frames of the CIB-16CR mount easily in a closet between panels or in a vanity drawer between cabinet sides from 14-1/4" to 21" wide. The fixed brackets allow for easy mounting of all standard drawer fronts. Ball-bearing slides provide over travel for maximum use. Open until the gravity lock engages, unfold board and you are ready to iron. Fits 16" depth. Board size: 12" x 29-3/16"

Dimensions:

14-1/4 - 21" W x 15-7/8" D x 4" H

Code	Description	List/ea
CIB-16CR	Fold Out Ironing Board - Closet Model	\$ 255.09

### BUILT-IN IRONING BOARD



Fits any drawer space and operates as simply as a drawer. Easy installation in all base cabinets with a drawer front. Sturdy steel construction with an epoxy coating. Screws, instructions and heat-resistant cover are included.

**\*Max Countertop Projection: 1-7/8"**

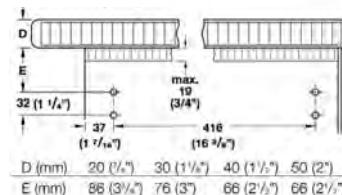
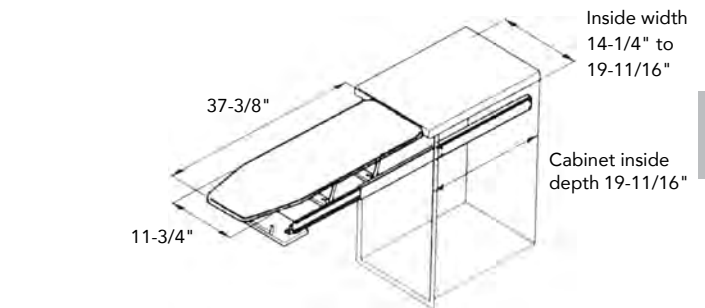

Use dimensions to match surface to countertop height

Code	Description	List/ea
568.60.710	Built-In Ironing Board	\$ 424.33



## IRONING BOARDS

### IRONAWAY IRONING CENTERS

Creates optimal ironing space with style. Complete with an adjustable swivel ironing board, premium electrical features and a hot iron rest. Cabinet is made of poplar wood and features a cool grey interior with unfinished exterior.



#### AE42 ELECTRICAL UNIT

Includes:

- 42" ventilated metal ironing board with cover/pad
- 180° adjustable swivel with 4" height adjustment
- Electrical features including a 60 min motor timer, spotlight, outlet, and a safety disconnect switch
- Cord wrap
- Hot iron rest/ storage area
- Garment bar

Dimensions:

Outside: 15"W x 60-5/8"H x 7-3/4"D  
Rough-in opening: 14-3/8"W x 59-7/8"H x 3-7/8"D

<u>Code</u>	<u>Description</u>	<u>List</u>
AE42ND	42" Swivel Ironing Center, No Door	\$ 985.22

#### AE46 ELECTRICAL UNIT

Includes:

- 46" ventilated metal ironing board with cover/pad
- 180° adjustable swivel with 4" height adjustment
- Electrical features including a 60 min motor timer, spotlight, outlet, and a safety disconnect switch
- Electrical cord cover
- Hot iron rest/ storage area
- Garment bar

Dimensions:

Outside: 15"W x 60-5/8"H x 7-3/4"D  
Rough-in opening: 14-3/8"W x 59-7/8"H x 3-7/8"D

<u>Code</u>	<u>Description</u>	<u>List</u>
AE46ND	46" Swivel Ironing Center, No Door	\$ 1118.49

### IRONAWAY IRONING CENTERS

Convenient for locations with a nearby outlet, these non-electrical NE42 ironing centers feature a fixed position 42-inch ironing board with premium sized hot iron storage. Cabinet is made of poplar wood and features a cool grey interior with unfinished exterior.



#### NE42 NON-ELECTRIC

Includes:

- 42" ventilated metal ironing board with cover/pad
- Cord wrap
- Hot iron rest/ storage area
- Garment bar
- Fully assembled and ready to install
- Unfinished Flush Wood Door (Maple Veneer) on NE42WDU

Dimensions:

Outside: 15"W x 52" H x 7-3/8"D  
Rough-in opening: 14-3/8"W x 51-1/4"H x 3-7/8"D

<u>Code</u>	<u>Description</u>	<u>List</u>
NE42NDU	42" Non-electric, No Door	\$ 676.14
NE42WDU	42" Non-electric, w/ Door	607.00

#### **Determine Mounting Height**

Identify your desired ironing board height (typical ironing board is 35" to 36" high). Then subtract the number below based on the length of your model's ironing board to determine mounting height. For adjustable swivel models, take into consideration the adjusted position of your ironing board, which is 4" higher than the normal default position.

##### **46" Boards: 11"**

Ex: Desired Height 35" - 11" = 24"  
Mounting Height

##### **42" Boards: 7"**

Ex: Desired Height 35" - 7" = 28"  
Mounting Height



## IRONING BOARDS

### **SWIVEL IRONING BOARD** With Over Travel

- Fits any partition at least 14" deep and 8" wide
- Board 38" long, 13" wide
- Tan canvas, 100% cotton cover (included)
- Overall height when stored: 72"
- Adjustable feet



Now there's room for the ironing board right in the closet with your clothes. Hugging a vertical panel, this swivel ironing board is available at a moment's notice. Just slide it out, swivel and lower the unit into position. Can be swiveled into several positions within a 90° radius of its mounting panel. From perpendicular to parallel, adjust it to the position that best suits you! (Iron not included.)

**Dimensions:**

5-1/4" W x 13" D x 53-1/8" H

<u>Code</u>	<u>Description</u>	<u>List</u>
CSWIBSL-14-SM-1	Swivel Ironing Boards	\$ 532.54

### **DROP OUT CABINET FIXTURES - Special Order** 8023 Ironing Center

The Dropout Ironing Center is a complete ironing system in one convenient cabinet. This pullout cabinet contains a full-size, proprietary custom 14" x 53" ironing board, complete with pad and cover, stainless steel iron dock, and ironing accessory storage spaces.



Completely out of sight but easily accessible when needed.

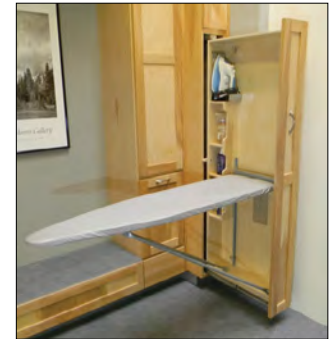

- Min Cab Opening:  
Width: 7"  
Height: 63"  
Depth: 23"
- Open Space requires Flat Top and Bottom for Slide Mounting

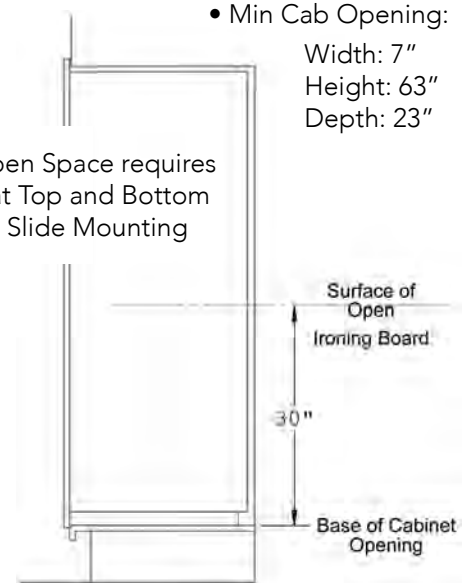

<u>Code</u>	<u>Description</u>	<u>List</u>
8023	Ironing Center	\$ 1838



# GLUE

## TITEBOND ORIGINAL WOOD GLUE



The original yellow PVA aliphatic resin glue; blended PVA and polyvinyl alcohol esters. More than twice as strong as white glue. Bonds wood, and other porous materials. Spreads easily, sets fast and is sandable. Resists heat and solvents. Nontoxic, nonflammable.

<u>Code</u>	<u>Size</u>	<u>Pack</u>	<u>List/ea</u>
506-3	8 oz.	12	\$ 5.26
506-4	16 oz.	12	9.05
506-6	1 Gallon	2	36.05
506-7	5 Gallons	1	172.52

## TITEBOND II PREMIUM WOOD GLUE



Titebond II is a crosslinking PVA glue. First one-part glue to pass type II water resistance. Dries very hard, sands easily, fast tack. High water and heat resistance. Fills small (1/32") gaps with strength. Solvent-free, non-toxic, paintable, water clean-up, freeze/thaw stable, resists solvents, environmentally safe. For wood, particle board and other porous materials. (Not for continuous submersion). Dries yellow.

<u>Code</u>	<u>Size</u>	<u>Ctn</u>	<u>List/ea</u>
500-3	8 oz.	12	\$ 6.44
500-4	16 oz.	12	10.48
500-6	1 Gallon	2	42.72
500-7	5 Gallons	1	192.40

## TITEBOND II EXTEND – longer open time

413-7	5 Gallons	1	\$ 234.75
-------	-----------	---	-----------

## TITEBOND II FLUORESCENT WOOD GLUE

Titebond II glue that contains fluorescent dye so glue can be seen under a black-light. 5 gallon pails only.



<u>Code</u>	<u>Size</u>	<u>List/ea</u>
231-7	5 Gal.	\$ 224.76

## TITEBOND III ULTIMATE WOOD GLUE



Titebond III combines the strength, sandability, ease of use and water cleanup of PVAs (aliphatic resins) with the durability, open time and water-resistance of polyurethanes. Especially useful for outdoor applications in cooler temperatures or when concern for moisture calls for the use of a water-resistant glue.

- Unaffected by finishes
  - Water clean-up, Non-Toxic
  - Sands easily w/o softening
  - Dries Neutral Tan
- |               |            |
|---------------|------------|
| Strength:     | 400psi     |
| Open Time:    | 10 minutes |
| Chalk Temp:   | 47° F      |
| Exterior Use: | Yes        |

<u>Code</u>	<u>Size</u>	<u>Ctn</u>	<u>List/ea</u>
1413	8 oz.	12	\$ 10.77
1414	16 oz.	12	14.91
1416	1 Gallon	2	57.16
1417	5 Gallons	1	301.36

## SUPER TITEBOND WOOD GLUE

A high-quality, professional woodworking glue that offers superior sandability and solvent-resistance. It resists stress imposed by heat and moisture during the production of panels, squares and other wood parts. This makes it the ideal choice for edge and face gluing as well as other woodworking operations.



<u>Code</u>	<u>Size</u>	<u>Ctn</u>	<u>List/ea</u>
507-7	5 Gallons	1	\$ 215.96



## GLUE

## GLUE BOTTLES

### TITEBOND EXTEND WOOD GLUE

Titebond Extend is a slower setting version of the Titebond Original. Use in hot weather or for complex assembly work. It is compatible with all common species of wood, as well as particle board, MDF, plywood and other porous materials. Dries yellow. Keep from freezing. Not for moist areas. For interior use. Clean up with damp cloth or scrape.

Application Temp	Above 40°F
Storage Life	6 mos. at 70°F
Assembly Time	15 mins. at 70°F
Bond Strength	72°F = 3,510 PSI* 150°F = 3,120 PSI*



<u>Code</u>	<u>Size</u>	<u>Ctn</u>	<u>List/ea</u>
910-6	1 Gallon	2	\$ 40.43
910-7	5 Gallon	1	196.73

### TITEBOND WHITE GLUE

Titebond White Glue is a strong, economical white glue that sets faster than most other comparable glues. It provides a strong initial tack and sets fast to reduce clamp time. Translucent glue line, excellent sandability and is unaffected by finishes.



Non-toxic and cleans up with water. Ideal for general wood-working applications, as well as many other porous and semi-porous materials.

<u>Code</u>	<u>Size</u>	<u>Ctn</u>	<u>List/ea</u>
502-6	1 Gallon	2	\$ 36.08
502-7	5 Gallons	1	176.42

### EMPTY GLUE BOTTLES AND SPOUTS

16 oz. Wide Plastic Bottles with Wide Spouts.

Order bottles and spouts separately.



<u>Code</u>	<u>Description</u>	<u>List/ea</u>
GBW	16 oz, 2-3/8" Dia.	\$ 2.24
GSW	1-1/4" Spout for GBW	.58

### GLU-BOT SPILL-PROOF GLUE BOTTLE

Fastcap



- Spill-proof nozzle
- Easy-squeeze bottle
- Never drip again
- Essential for every craftsman
- Vacuum valve keeps glue level high, even when you're getting low!
- Replacement tips sold separately

<u>Code</u>	<u>Description</u>	<u>List</u>
GLU-BOT	16 oz. Glue Bottle	\$ 11.26/ea
GB-BLADE	Replacement blade tips, 5 ea/ pack	2.83/pk





## GLUE

### MELAMINE GLUE

"ROO-CLEAR"

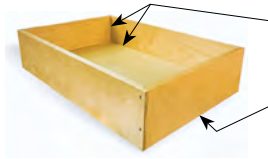

AV56-1



AV56-16

For all melamine butt joints, including anchoring drawer bottoms to sides, especially at front & back where currently only staples are holding bottoms to front & back pieces.

Melamine "Roo" Glue is specifically made for bonding melamine coated boards. Makes butt joints stonger than the board's surfaces. Dries translucent (clear). Waterbased and non-toxic. 20 years in use; proven long term.

<u>Code</u>	<u>Size</u>	<u>Ctn</u>	<u>List/ea</u>
AV56-16	16 oz.	12	\$ 12.15
AV56-1	1 Gallon	4	61.23

### TITEBOND MELAMINE GLUE

Thick formula bonds wood, particle board, MDF and other porous substrates to synthetic materials such as melamine, vinyl and HPL as well as metals. Fast initial tack, yet has a long open time that allows for the accurate alignment of working materials.



A water-based adhesive that is non-flammable, has low odor, dries clear and cleans up with water. Thick formulation for fewer runs and drips. Assembly time after glue application: 10-15 min (at 70° F).

<u>Code</u>	<u>Size</u>	<u>Ctn</u>	<u>List/ea</u>
4014	16 oz.	12	\$ 10.47
4016	1 Gallon	2	41.92

### TITEBOND DOWELING GLUE

Low Viscosity



Designed for use with automatic doweling equipment. Its low viscosity (140 cps) allows the appropriate flow through the narrow feed lines and injectors of European-made doweling machinery. Sets fast to reduce assembly time, offers excellent strength and provides a translucent glue line.

For use on solid wood, particle board, MDF, plywood and other porous materials. 5 Gallon pails.

<u>Code</u>	<u>Description</u>	<u>List/ea</u>
381-7	Doweling Glue, 5 Gal.	\$ 167.11

### TITEBOND SPEED SET WOOD GLUE

Titebond Speed Set Wood Glue is an extremely fast-setting, high solids PVA adhesive. It provides exceptional gap filling properties developing a bond stronger than the wood itself. This product offers excellent sandability, unaffected by finishes, and increases productivity through its shorter clamp time with no increase in viscosity. Titebond Speed Set is non-toxic and cleans up with water.



- Extremely fast set – 15 minute clamp time
- Excellent strength & durability
- Visible under black light
- Unaffected by finishes
- Heat resistant – Sands easily
- Easy water cleanup

<u>Code</u>	<u>Size</u>	<u>Ctn</u>	<u>List/ea</u>
436-6	1 Gallon	2	\$ 55.00

## GLUE

### SUPER BOND ADHESIVE SYSTEM - Fastcap 2P10

With 2P-10 you can easily glue the hardest joints in cabinetry without clamping!  
 Bonding time: 10 seconds, Cure time: 30 seconds.

**Solo Kit:**

12 oz Activator  
 2+ oz Thick Adhesive



**Sold Separately:**



12 oz. or 3.5 oz.  
 (mini) Activator



10 oz.  
 Adhesive



2.25 oz.  
 Adhesive



2P - 2 parts



Breaks the wood, not the glue

Choose from four adhesive types:



- Excellent for filling micro cracks
- Zero glue line



- For use on smooth surfaces such as laminate
- Excellent for filling medium cracks



- For use on porous surfaces such as particle board



- Will not run
- All purpose application
- Excellent for vertical surfaces

Code	Description	List/ea
2P10-ACTIVATOR	12 oz. Activator Aerosol	\$ 23.01
2P10-JEL-2	Jel Adhesive, 2.25 oz.	23.01
2P10-JEL-10	Jel Adhesive, 10 oz.	89.74
2P10-THICK-2	Thick Adhesive, 2.25 oz.	18.40
2P10-THICK-10	Thick Adhesive, 10 oz.	64.06
2P10-MED-2	Med Adhesive, 2.25 oz.	18.40
2P10-MED-10	Med Adhesive, 10 oz.	65.16
2P10-THIN-2	Thin Adhesive, 2.25 oz.	18.40
2P10SOLO	Kit Includes: 1 ea. 12 oz. Activator 1 ea. 2+ oz. Thick Adhesive	40.95

### TITEBOND MOLDING & TRIM WOOD GLUE

Quick & Thick



Thickest, fastest drying glue for use with porous and semi-porous materials. Ideal for finish trim, crown molding, baseboards, window casings and other applications requiring a professional strength, no run wood glue.

Strong initial tack and fast speed of set, yet allows realignment of working pieces.

Develops a bond stronger than the wood itself, offers excellent sandability and is unaffected by finishes.

Code	Size	Ctn	List/ea
2404-	16 oz.	12	\$ 10.41

### TITEBOND COLD PRESS FOR VENEER

A high quality, economical alternative to contact cement for large-scale bonding of veneers to flat surfaces. Specifically formulated PVA glue for cold press laminating of wood to solid woods, particle board, MDF, plywood and other porous materials. Water-based.



- Economical alternative to contact cement
- Formulated to minimize "bleed-through"
- Moderate speed of set, 15 min. at 70° F
- No harmful vapors
- Safe - nonflammable
- Application Temp: Above 50° F
- Clamp at 100-200 PSI
- Freeze-Thaw stable (stir before using)
- Tan in color, dries dark brown

Code	Size	Ctn	List/ea
517-6	1 Gallon	2	\$ 43.18
517-7	5 Gallon	1	166.82



## CONTACT CEMENT

### 3M "FASTBOND" No. 10 - BRUSH TYPE



Yellow  
Contact Cement  
**FB10**

For professional or industrial use only. A yellow adhesive used for bonding decorative laminates, aluminum, steel, copper, wallboard, plywood panels, wood and wood veneer, masonry, rubber, leather, canvas, and other porous and non-porous materials to each other or to themselves. Oil, water, and heat resistant. Coverage: up to 200 square feet/ gallon. Flammable. VOC Rating: 422 grams/liter.

<u>Code</u>	<u>Size</u>	<u>List/ea</u>
FB10-1NU	1 Gallon	\$ 189.65
FB10-5NU	5 Gallon	714.37

### 3M "FASTBOND" No. 30 - WATER BASE



Neutral  
Contact Cement  
**FB30**

A water dispersed adhesive available in green or neutral. Has high immediate bond strength, a long bonding range, and good heat resistance. Used to bond foamed plastics, plastic laminate, wood, plywood and wood veneer, wall board, plaster and canvas to themselves and to each other as well as for post forming operations. Meets requirements of MIL-A-24179-A. Non-flammable, odorless, liquid adhesive for brush, roller or spray application. Not recommended for use on metal surfaces. Covers up to 320 square feet/ gallon.

<u>Code</u>	<u>Color</u>	<u>Size</u>	<u>List/ea</u>
FB30-1NU	Neutral	1 Gallon	\$ 214.31

### DAP WELDWOOD CONTACT CEMENT

Contact cement, Smooth Spreading Grade: Maximum strength, waterproof, fast drying. Neoprene and resin formulation provides maximum strength and toughness. Permanently bonds laminates to wood, plywood, hardboard, metal, or plaster. Heat resistant and waterproof. Fast drying. Tan color. VOC Rating: 700-710 grams/liter.



00273

Can be applied with a brush or a roller.

<u>Code</u>	<u>Size</u>	<u>Ctn</u>	<u>List/ea</u>
00273	1 Gallon	4 ea.	\$ 63.91

## CONTACT CEMENT

## EVERSTRONG

### EVERSTRONG CONTACT ADHESIVE ES10

A high performance industrial strength contact adhesive formulated with extremely low VOCs to comply with CA and OTC state regulations. Water resistant and temp resistant to over 200° F, ES10 is designed for bonding a wide range of substrates to include decorative laminates and veneers, fiberglass, glass, fabrics and particle board. Flammable. Postformable.



ES10P-13C



ES10-05C



ES10-27

- High Temp resistance
- Pebble spray pattern
- Postformable
- Low VOCs: Rated < 80 g/L. No Haps.
- SCAQMD Rule 1168 & OTC Compliant
- LEED Compliant
- Everstrong Fast Tack Bond Performance



ES10-130

Code	Description	List/ea
ES10P-13C	13 oz. Aerosol Spray, Clear	\$ 14.71
ES10-27C	27 lb Canister, Clear	491.51
ES10-27R	27 lb Canister, Red	468.10
ES10-05C	5 Gallon pails, Clear Bulk	408.04
ES10-05R	5 Gallon pails, Red Bulk	408.04
ES10-130C	130 lb Canister, Clear	2027.51
ES10-130R	130 lb Canister, Red	2027.51

### Tips for using Newstar Everstrong



#### 1. Canister Version

- Existing Hoses & Guns can be used.
- Hoses & Gun should be purged.
- A new tip needs to be added to existing spraygun, part no: TIP, in order to properly disperse product.
- Larger user should purchase an extra tip for backup.
- Product will spray in "pebble" pattern.

#### 2. Pail Version

- We stock 5 gallon pails.
- You can brush, roll or spray. Spray with pressure pot or 55 gallon "pogo pump" cylinder.
- Spray Gun recommendations:  
 The Binks # MACH1 gun is commonly used.  
 Use a 94 or 86 Tip with a 1.4mm opening.
- Product will spray in "pebble" pattern.

#### 4. General Info

- Canisters coverage:
  - 80-90 sq ft per lb.
  - 8 lb = 640 - 720 sq ft
  - 27 lb = 2,160 - 2,430 sq ft
- 5 gallon pail coverage:  
 1250-1500 sq ft per 5 gallons approx.
- No gluebond reaches 100% for at least 24 hrs, but applied Everstrong products are ready to machine immediately.
- Easy clean-up with Acetone.
- Acetone does dry out bearings in flush trim router bits, paint thinner can also be used for clean up - easier on bearings.

#### Storage for ES10, ES80, ES110, ES180:

After use leave valve open, leave gun and hose connected to canister. Ensure that the adhesives and substrates are at 60° F or higher.

#### Shelf Life for ES10, ES80, ES110, ES180:

15 months. Not damaged by freezing but return to room temp before use.



## EVERSTRONG

## CONTACT CEMENT

### EVERSTRONG CONTACT ADHESIVE ES80

ES80 is a high strength, high temperature, low odor contact adhesive with long open time. Provides strong permanent bonds for a wide variety of substrates to include decorative laminates and veneers, fiberglass, glass, fabrics, foam, cork and particle board. Low VOCs to comply with CA and OTC states regulations.

- Long Open Time
- Low Odor
- Low VOCs: Rated < 80 g/L. No Haps. No ODS.
- SCAQMD Rule 1168 & OTC Compliant
- LEED Compliant, CA Compliant
- Fast Tack Bond Performance
- High Temp resistance
- Web spray pattern
- Flammable DOT



ES80-27

<u>Code</u>	<u>Description</u>	<u>List/ea</u>
ES80-05C	5 Gallon pails, Clear	\$ 390.35
ES80-05R	5 Gallon pails, Red	473.72
ES80-27C	27 lb Canister, Clear	544.94
ES80-27R	27 lb Canister, Red	506.36
ES80-140C	140 lb Canister, Clear	2687.05
ES80-140R	140 lb Canister, Red	2687.05

### SPRAY GUNS / TIPS

Can be used with all stocking canisters.



<u>Code</u>	<u>Description</u>	<u>List/ea</u>
ES007	Spray Gun w/ 6501 Tip	\$ 437.38
TP6501	Brass Tip for Gun	34.10

### EVERSTRONG CONTACT ADHESIVE ES35 - NF

EverStrong™ ES35 is a high performance versatile industrial strength contact adhesive that is rated NF/NF. Water resistant and temperature resistant to over 200°F, designed for bonding a wide range of substrates including decorative laminates and veneers and particle board.

Designed to be applied to both surfaces about to be joined. Spray an even coat of adhesive with at least 80% to 100% coverage of each surface. Allow to dry 3-5 minutes until tacky. Place the surfaces together and apply pressure evenly across the full bonding surface.

- Non-Flammable (Green Label)
- No ODS (Ozone depleting substances)
- High Temperature Resistance
- Fast Tack
- Water Resistant



<u>Code</u>	<u>Description</u>	<u>List/ea</u>
ES35-38R	38 lb Canister, Red	\$ 959.62



## Air-Assist Canister Adhesives....The Best of Both Worlds!

NewStar's unique hybrid Air Assist adhesive spray system combines the best of conventional spray and canister adhesive systems.

NewStar's proprietary formulations significantly reduce VOCs from propellants while increasing the payload of adhesives in every canister. Improved yields and improved emissions.



- Greater yields
- Full range of spray patterns
- Fast, easy, clean set up
- No messy pressure pot or cup
- Longer, uninterrupted adhesive supply
- No mixing, no stirring, no pumping, no clean up
- Lower VOCs
- Everstrong Fast tack bond performance
- High temperature resistance
- Low maintenance

### Installation:

- 1) Attach compressed air line to air inlet (5), initial air pressure set at ZERO.
- 2) Check and confirm that adhesive tank valve is fully closed.
- 3) Attach adhesive hose to canister.
- 4) Attach a hose adaptor fitting (1/4" male NPT/ 3/8" female NPT) to adhesive hose (adaptor fitting wavailable at most hardware supply).
- 5) Attach adhesive hose to adhesive/fluid passage fitting on BINKS 2101 type spray gun.

### Spray Set Up:

- 1) Confirm air pressure adjustment is at ZERO pressure.
- 2) Open adhesive tank valve 1/2 turn such that adhesive stream is shallow arc from gun tip.
- 3) Slowly increase air pressure from 0 psi until desired spray pattern. Optimal spray air pressure is typically between 10 to 20 psi.

**CAUTION:** Higher air pressure will result in excess atomization and 'fogging' spray.

### Recommended Spray Gun spec:

BINKS 2101-4308-2  
(or equal)

Air nozzle: 66SD-3

Fluid tip: 66SS (.070)

Needle: 565

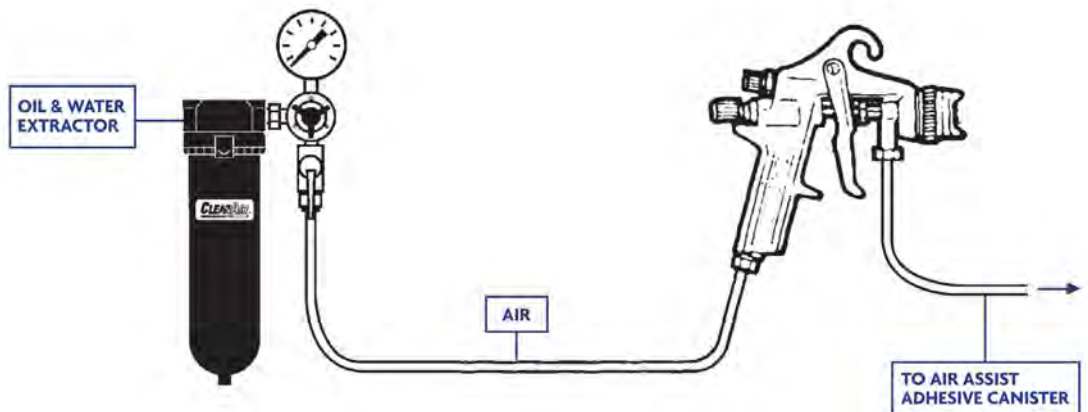

### CA Compliant Contact Adhesive

Code	Description	List/ea
ES110-27C	27 lb Canister, Clear	\$ 468.58
ES110-130C	130 lb Canister, Clear	2238.98

### CA Compliant W/ Extended Open Time

Code	Description	List/ea
ES180-27C	27 lb Canister, Clear	\$ 725.00
ES180-140C	140 lb Canister, Clear	1877.88
ES180-140R	140 lb Canister, Red	1877.88

## EVERSTRONG AIR ASSIST

### EVERSTRONG ADHESIVE ES110 - AIR ASSIST

An industrial contact adhesive specifically designed for air assist spray application. Applied on both surfaces to be adhered, ES110 is a high strength, high temp (over 200° F) contact adhesive providing strong permanent bonds for a wide variety of substrates to include decorative laminates and veneers, fiberglass, glass, fabrics and particle board. Formulated with no VOCs to comply with CA and OTC states regulations. Flammable. Postformable.

- Specifically designed for Air Assist Spray
  - Uses most std. spray guns
  - Requires connection to clean, compressed air source
  - Pebble Spray Pattern
- No VOCs: Rated 0 g/L. No Haps.
- SCAQMD Rule 1168 & OTC Compliant
- LEED Compliant
- Postformable



ES110

Code	Description	List/ea
ES110-27C	27 lb Canister, Clear	\$ 468.58
ES110-130C	130 lb Canister, Clear	2238.98

### EVERSTRONG ADHESIVE ES180 - AIR ASSIST

Specifically designed for air assist spray application. Its excellent performance characteristics combined with its extended open time and CA compliance make it a truly superior adhesive. Applied on both surfaces to be adhered, ES180 is a high strength, high temp (over 200° F) contact adhesive providing strong permanent bonds for a wide variety of substrates to include decorative laminates and veneers, fiberglass, glass, fabrics and particle board. Formulated with extremely low VOCs to comply with CA and OTC states regulations. Flammable. Postformable.

- **Long Open Time, Extra Strength**
- Specifically designed for Air Assist Spray
  - Uses most std. spray guns
  - Requires connection to clean, compressed air source
  - Web or Pebble Spray (w/ typical adjustable gun)
- VOCs: <80 g/L, No ODS, No Haps.
- SCAQMD Rule 1168 & OTC Compliant
- LEED Compliant



ES180

Code	Description	List/ea
ES180-27C	27 lb Canister, Clear	\$ 725
ES180-140C	140 lb Canister, Clear	1877.88
ES180-140R	140 lb Canister, Red	1877.88

## ADHESIVE REMOVER

### EVERSTRONG CITRUS ADHESIVE REMOVER

EverStrong CC is a citrus-based adhesive cleaner designed to remove most adhesives from surfaces. Removes adhesives, oil, ink, decals, tar and similar residues. Flammable.



ES10-CC

- Environmentally Friendly
- No Chlorinated Solvents
- Flammable
- Biodegradable
- Citrus-based, Pleasant Odor
- No ODS (Ozone Depleting Substances)



ES10-CC

Code	Description	List/ea
ES10-CC	14 oz. Aerosol can	\$ 15.21
ES10-8C	8 lb. canister	190.10

### 3M™ ADHESIVE REMOVER

Low Voc



3M™ Industrial Cleaner and Adhesive Remover. Low VOC <20% is ideal for helping dissolve and remove dirt, grease, tar, and many non-curing type adhesives. Cleans without streaking and is excellent for surface preparation in adhesive applications. While these multipurpose cleaners are suitable for industrial use, they are also safe enough for everyday projects.

24 fl. oz. (Net Wt 18.7 oz.)

Code	Description	Ctn	List/ea
97974	Adhesive Remover, Low VOC	12 ea	\$ 51.30



## SPRAY ADHESIVES

### EVERSTRONG CONTACT ADHESIVE



#### **ES10+ Spray Adhesive**

A high performance industrial strength contact adhesive formulated with extremely low VOCs to comply with CA and OTC state regulations. Water resistant and temp resistant to over 200° F, ES10 is designed for bonding a wide range of substrates to include decorative laminates and veneers, fiberglass, glass, fabrics and particle board.

Longer open time, better spray pattern, CA VOC Compliant. Flammable. Postformable.

<u>Code</u>	<u>Description</u>	<u>Ctn</u>	<u>List/ea</u>
ES10P-13C	13 oz. Aerosol Spray, Clear	12 ea	\$ 14.71

### 3M™ SUPER 77CA MULTI-PURPOSE SPRAY



3M™ Super 77™ CA Multi-Purpose Spray Adhesive - Low VOC <25% is an extremely versatile, fast-drying adhesive that bonds a wide range of lightweight materials quickly, without soaking through. Its fast, aggressive tack makes it ideal for a wide variety of projects.

This adhesive is CARB\* and SCAQMD compliant, GREENGUARD® certified and helps contribute to LEED® credits. 24 fl. oz. (Net Wt 18 oz.)

<u>Code</u>	<u>Description</u>	<u>Ctn</u>	<u>List/ea</u>
77-CA	Spray Adhesive, Clear Low VOC, Carb Compl.	12 ea	\$ 33.30

### 3M™ HIGH STRENGTH SPRAY ADHESIVE



3M™ Hi-Strength 90 CA Spray Adhesive - Low VOC <25% is an extremely versatile, fast-drying spray adhesive that bonds strongly to a wide range of materials. Easy to dispense and offers a variable-width spray pattern, applying directly onto surfaces and materials where needed.

Has a very aggressive tack that combines a high initial grab with sufficient open time to position materials properly. CARB\* and SCAQMD compliant, GREENGUARD® certified, helps contribute to LEED® credits. 24 fl. oz. (Net Wt 19 oz.)

<u>Code</u>	<u>Description</u>	<u>Ctn</u>	<u>List/ea</u>
90-CA	Spray Adhesive, Clear Low VOC, Carb Compl.	12 ea	\$ 45.00





## HOT MELT

### 3M HOT MELT APPLICATOR TC/TC-Q GEN II

From high volume to detail work, 3M Hot Melt Applicators ensure optimum performance through melt-on-demand or progressive feed technology to meet your production deadlines.



- Lightweight designs offer easy handling
- Uniquely designed for 3M Hot Melt adhesives sticks
- Balanced design for easy, controlled application
- Comfortable and ergonomic

Operating Temperature: 385 °F  
 Stick or Slug Diameter: 5/8"  
 Flow Rate: 3.5 lb/hr  
 Voltage Rating: 120V

Code	Description	List/ea
TC-TCQ	Hot Melt Applicator	\$ 295

### 3M JET MELT ADHESIVE



Mini - 2" x 5/8"  
3792-2



Quadrack - 8" x 5/8"  
3747-8  
3792-8

- 3747: General purpose including melamine, plastic and wood. Good thermal stability. Good heat resistance & flexibility.
- 3792: Clear, high-performance, general purpose adhesive with a long open time and good delivery rate. Excellent adhesion to most plastics, glass and wood. Good resistance to shock at both 0°F and ambient temp.

Code	Description	Case	List/case
3792-2	Mini, Clear	11 lbs.	\$ 347.13
3747-8	Quadrack, Tan	11 lbs.	465.14
3792-8	Quadrack, Clear	11 lbs.	364.13

### 3M SCOTCH-WELD HOT MELT ADHESIVE

Provides a tough, reliable bond for a wide variety of applications. Formulated to have moderate heat resistance, it offers you a bond that can withstand elevated temperatures without lifting or deformation, delivering long-term durability and exceptional performance.



Code	Description	Box	List/bx
3747PG	Hot Melt, 1" x 3"	22 lbs.	\$ 862.73

### FASTCAP SPEEDTAPE Contact Cement on a Roll



1" - Great for edgebanding



2" - Great for face frames

SpeedTape is an ultra bond transfer adhesive. Apply to a substrate then peel off paper backing and stick on laminate or veneer. Excellent for refacing, locating moldings, eliminating nail holes, and cabinet scribe. Apply edging without the glue clean-up from sprayed or rolled glue. Rolls are 50'. Other sizes can be special ordered.

Code	Size	List/rl
ST-34	3/4" x 50'	\$ 13.27
ST-1	1" x 50'	17.58
ST-2	2" x 50'	35.16

## CAULK

### DAP TUB & TILE CAULK

"Kwik Seal"

Gives a watertight seal around tubs, showers, and sinks. Easy clean-up with damp cloth. Dries fast, stays flexible. Resets loose tile. Collapsible plastic tubes. 5.5 fl. oz. each.

Code	Color	Ctn	List/ea
18003	White	12	\$ 5.69
18013	Almond	12	5.69

### LOCTITE POLYSEAMSEAL ADHESIVE CAULK

An all-purpose waterbase adhesive caulk for exterior or interior seams requiring a flexible seal. Water and mildew resistant. Bonds wood, brick, aluminum, painted surfaces, masonry, plastics metal, plaster, drywall & cement/concrete.

Cartridges: 10 fl. oz.

Code	Color	Ctn	List/ea
J20WH	White	12	\$ 10.64
J20TR	Translucent	12	17.18

### DAP SILICONE

100% Silicone rubber protects and seals without crumbling, cracking or drying out. Waterproof and weatherproof. 10 fl. oz. cartridge. 12 ea/ctn.

Code	Color	Ctn	List/ea
08641	Clear	12	\$ 15.23

1711



## ADHESIVE CAULK

### PHENOSEAL ADHESIVE CAULK

The Phenolic-Vinyl Caulking Adhesive. Rugged, permanently flexible, heat resistant, waterproof. Bonds wood, tile, metal, glass, fiberglass, stone - almost any material to any other material. Forms wood joints stronger than wood itself. Does not crystallize or crumble. Completely unaffected by exposure to sunlight, salt, water, gasoline, oil, mild acids, and alkalis. Waterbased and environmentally safe. 10 fl. oz. cartridges.



Code	Color	Ctn	List/ea
102B	Black	12	\$ 12.35
102MG	Metal Gray	12	8.07
102TR	Transparent	12	10.96
102WH	White	12	12.38

### DAP '33' WINDOW GLAZING

A ready-to-use glazing compound ideal for face glazing wood or metal sash. Its knife grade consistency allows for smooth, easy applications. It adheres tightly to glass and sash and resists sagging, cracking, shrinking and chalking, forming an airtight and watertight seal. Interior/exterior use. Paintable. One Gallon size.



Code	Size	Ctn	List/ea
12019	Gallon	2	\$ 61.38

### DAP SPACKLING COMPOUND

A smooth, easy working white vinyl paste spackling compound. Patches plaster, dry wall and wood surfaces. Ready-mixed, takes paint almost immediately without priming. Meets Fed Spec. SS-P-00450A, Type II



Code	Size	Ctn	List/ea
12130	8 oz.	12	\$ 6.15
12002	Quart	6	13.44



## BUILDING ADHESIVES

### TITEBOND 100% SILICONE SEALANT

A versatile 100% silicone formula. It offers excellent adhesion to many common construction materials, including vinyl, aluminum, glass and painted surfaces. Provides a strong, flexible seal that offers excellent water-resistance. Extrudes easily in lower temperatures and dries quickly. 10.1 fl. oz. cartridge.



<u>Code</u>	<u>Color</u>	<u>Ctn</u>	<u>List/ea</u>
2601	White	12	\$ 20.29
2611	Clear	12	16.85

### DAP "ALEX PLUS"

Acrylic Latex Caulk Plus Silicone

Acrylic latex caulk plus silicone is a professional quality, paintable, multi-purpose caulk for interior or exterior use. The silicone adds better adhesion and durable flexibility. Fast drying and cleans up with water. 25 year durability. 10.1 fl. oz. cartridge.



<u>Code</u>	<u>Color</u>	<u>Ctn</u>	<u>List/ea</u>
18101	White	12	\$ 6.04
18156	Clear	12	6.63

### DAP '230' SEALANT LATEX CAULK

The '230' latex sealant has the superior performance features of silicone. It withstands up to 50% total joint movement for weathertight protection. Paintable and cleans up with water. Permanent adhesion and lifetime flexibility. 50 year durability. 10.1 fl. oz. cartridge.



<u>Code</u>	<u>Color</u>	<u>Ctn</u>	<u>List/ea</u>
18300	White	12	\$ 9.58
18306	Almond	12	9.54
18412	Cedar Tan	12	8.48
18302	Brown	12	9.41
18303	Dk Bronze	12	7.36
18280	Black	12	9.58
18305	Clear	12	8.51

### LOCTITE HEAVY DUTY SUB-FLOOR & DECK ADHESIVE

A powerful permanent bond for all heavy duty construction, interior or exterior, such as sub-flooring, exterior sheathing, siding, decks, metal and FRP panels. Virtually unaffected by weather extremes.

VOC compliant formula for California. Product meets stringent new California State CARB and Federal VOC Regulations.

White in Color.



<u>Code</u>	<u>Size</u>	<u>Ctn</u>	<u>List/ea</u>
P125-V	10 oz.	12	\$ 5.69
P145-V	28 oz.	12	11.29



## BUILDING ADHESIVES

### LOCTITE PREMIUM CONSTRUCTION ADHESIVE

A one component, polyurethane based, moisture-curing adhesive. VOC compliant and contains no chlorinated solvents or water. Provides superior adhesion to most common construction materials: wood, treated wood, hardwood flooring, concrete, stone, marble, slate, masonry, brick, foam insulation of all sorts, carpets, metal, lead, cement-based products, ceramic, fiberglass, drywall and mirrors.

Can be used for interior or exterior projects and is three times as strong as conventional solvent based construction adhesives. Waterproof, paintable and cures even in cold temperatures. Ideal for sub floor installations. Open time: 30 minutes. Tan in color. Cartridge is 10 fl. oz.



<u>Feature</u>	<u>Benefits</u>
Low VOC content (45g/L).....	Meets stringent state & federal regulatory requirements
Waterproof.....	Great for interior or exterior applications
Meets & exceeds APA.....	Can be applied directly to dry, wet or frozen lumber
Low Odor.....	No strong solvent odor; great for interior use
Strong & versatile.....	Permanently bonds together almost any substrate
High Strength.....	Stronger than many substrates it joins together; up to 3 times the strength of conventional adhesives
Broad Service Temp.....	Suitable for use in hot and cold environments (0° F to 160° F)

<u>Code</u>	<u>Color</u>	<u>Ctn</u>	<u>List/ea</u>
PL-PREM	Tan	12	\$ 10.86

(Not recommended for plastic tub surrounds, water submersion, polystyrene, polyethylene or polypropylene. Some materials such as rubbers and plastics may have bonding difficulties and you should test before using.)

### LOCTITE POWER GRAB CONSTRUCTION ADHESIVE

High-quality, easy-to-use construction adhesive for bonding most common construction materials such as wood, plywood, MDF, tile, and more. Reduces need for bracing and nailing with quick initial tack; formula sets in 10 minutes and cures in 24 hours. Solvent free and VOC compliant.

**Strong & Versatile:** Works in all conditions and on most materials, including wet surfaces and can even bond two non-porous surfaces.

**Tough against Weather:** Strong adhesion with no shrinkage that's waterproof and resistant against extreme temperatures from 40°F to 104°F for interior and exterior projects.



**GREENGUARD certified** and meets subfloor rated spec ASTM D-3498 and APA AFG-01.

<u>Code</u>	<u>Color</u>	<u>Ctn</u>	<u>List/ea</u>
PG-9	White	12	\$ 15.94

### TITEBOND PRO HEAVY DUTY ADHESIVE Construction Adhesive

Ideal for bonding most common materials including wood, metal, brick, marble, ceramic tile, concrete, drywall and wet, frozen and treated lumber. Meets today's most stringent State and Federal VOC regulatory requirements. Fills gaps between materials and reduces the amount of nailing.



- VOC Compliant
- Waterproof
- Superior strength
- Fast initial grab
- Bonds heaviest materials
- Extrudes 0° F - 100° F
- Passes AFG-01, ASTM D3498

<u>Code</u>	<u>Size</u>	<u>Case</u>	<u>List/ea</u>
525-1	10 oz. tube	12 ea.	\$ 6.58



## BUILDING ADHESIVES

### QUICK CURE 5 ADHESIVE

Quick Cure-5 is the standard quick setting "five minute epoxy" system. Mix at 1:1 by volume ratio. Ideal for all small jobs requiring a strong bond and rapid cure. Highly water resistant, but not waterproof. Quick Cure is quite thick, but is easily measured by squeezing equal sized lumps from the convenient application bottles.



**Recommended uses:** Use Quick Cure for installing bungs, repairing missed staple holes prior to fiberglassing, "tack welding" wood, and for those other glue jobs which require a fast cure. Do not use below the water line.

<u>Code</u>	<u>Description</u>	<u>List/Kit</u>
1000K10	Quick Cure 8 oz.	\$ 37.35
1000K14	Quick Cure 1 pint	67.80
1000K16	Quick Cure 1 qt.	96.58

### T-88 STRUCTURAL EPOXY ADHESIVE

T-88 is a high-performance, non-brittle, two part epoxy adhesive designed to give superior results under adverse conditions. The adhesive may be used without modifications in normally fitted, and will cure in any thickness without shrinkage. T-88 is clear amber and becomes virtually invisible when varnished. Exhibits outstanding adhesion and permanence on a wide variety of materials.



**Recommended uses:** For well over 25 years T-88 has been the most widely used structural adhesive for marine and general woodworking use in the U.S. Mixed at 1:1 by volume ratio, T-88 will cure at temperatures as low as 35° F. When fully cured, it is unaffected by water, oil, kerosene, and many other chemicals. It will not stain wood and is immune to fungus and rot. T-88 is unique in that it may be applied to damp wood, provided it is worked well into the surface.

<u>Code</u>	<u>Description</u>	<u>List/Kit</u>
1100K14	T-88, 1 pint	\$ 55.96



## LUBRICANTS

### BOSTIK GLIDECOTE

Tool & Surface Sealant

For saw tables, jointer tables, etc. Forms a transparent shield that dries in seconds. Dramatically reduces sliding friction and allows you to handle heavy sheets of wood easily.



Contains no silicones or petroleum oils, so it will not stain wood or affect wood-finishing. Also prevents rust and corrosion. Use with ventilation.

<u>Code</u>	<u>Size</u>	<u>Ctn</u>	<u>List/ea</u>
278-3110	10.75 oz.	12	\$ 36.05

### BOSTIK BLADECOTE

Dry Lubricant

Aerosol lubricant spray to be used on blades, bits, and other cutting tools. Forms a thin, transparent, low friction coating that mechanically bonds to the coated surface. Ideal for wood-cutting tools.



Does not contain any silicones or petroleum oils so will not affect the wood finish. Prolongs tool life, allows finer cuts. Use on sawblades, router bits, shaper cutters, drill bits, planer blades, ball-bearings and moving mechanisms. Use with ventilation.

<u>Code</u>	<u>Size</u>	<u>Ctn</u>	<u>List/ea</u>
278-1110	10.75 oz.	12	\$ 36.56

### 3M SILICONE LUBRICANT

Low VOC

Silicone based release agent for industrial lubrication applications. A green, environmentally sustainable product designed to improve the safety of your projects without sacrificing product performance. Fast drying to maintain productivity. Long lasting and non-staining to keep work surfaces clean. California compliant, 13.4 oz. aerosol cans.



<u>Code</u>	<u>Size</u>	<u>Ctn</u>	<u>List/ea</u>
SL-CA	13.4 fl. oz.	12	\$ 31.27

### SLIPIT LUBRICANT

Slipit silicone-free, non-flammable and non-toxic lubricant acts as a sealant and lubricant for sliding surfaces and tools. Slipit is parafin and mineral oil based for user safety.



Does not affect finishing process. Reduces friction, wear and sticking. Extends the life of tools, blades and bits. Prevents rust and oxidation. Out-performs paste wax. Seals wood to prevent sticking, swelling and binding.

<u>Code</u>	<u>Size</u>	<u>Ctn</u>	<u>List/ea</u>
12236	12 oz.	12	\$ 19.32



## MOHAWK

## WOOD REPAIR

### MOHAWK TOUCH-UP MARKER SET

12 Marker Assortment

**M267-1208**  
Marker Assortment  
Contains 12 colors



The Pro-Mark™ II capillary marker features excellent flow, 1 inch or 20 feet. The colors are fade-resistant, resistant to color shift from topcoating and are bleed resistant. Lacquer based solvent formula.

The nib remains usable for the life of the marker. Marks equally well with the edge, the bottom or the tip. Good adhesion to most surfaces and resistance to polishes is built-in.

Sold as a full set of 12. Individuals available special order.

<u>Code</u>	<u>Description</u>	<u>List/st</u>
M267-1208	12 Marker Assortment	\$ 125.56

The M267-1208 contains one each of:

- M267-0094 Warm Brown Walnut
- M267-0207 Med. Walnut/Brown Pecan
- M267-0224 Plum Black
- M267-0227 Dark Red Mahogany
- M267-0266 Newport-Ebonized Cherry
- M267-0337 Golden Oak
- M267-0355 Medium Oak
- M267-0365 Warm Walnut
- M267-0387 Mahogany
- M267-0406 Salem Maple
- M267-0477 Natural Maple
- M267-1516 Pine



### MOHAWK TOUCH-UP MARKER SET

36 Marker Assortment

**M267-3600**  
Marker Assortment  
Contains 36 colors



Sold as a full set of 36. Individuals available special order.

<u>Code</u>	<u>Description</u>	<u>List/st</u>
M267-3600	36 Marker Assortment	\$ 376.55

The M267-1208 contains one each of:

- M267-0003 Natural Ash
- M267-0004 Light Oak
- M267-0207 Walnut/Pecan Med. Brown
- M267-0209 Extra Dark Walnut
- M267-0224 Plum Black
- M267-0227 Dark Red Mahogany
- M267-0246 Red Brown Mahogany
- M267-0249 Perfect Brown
- M267-0252 Walnut/Brown Oak Lt.
- M267-0321 Lt. Natural Oak
- M267-0355 Medium Oak
- M267-0363 Dark Red Walnut
- M267-0364 Heartwood Walnut
- M267-0365 Warm Walnut
- M267-0385 Deep Cordovan
- M267-0387 Mahogany
- M267-0388 Cherry/Fruitwood
- M267-0406 Salem/Maple
- M267-0408 Cherry
- M267-0411 Nutmeg
- M267-1478 Van Dyke Brown
- M267-1516 Pine
- M267-2052 Medium Dark Oak
- M267-0063 Honey Maple
- M267-0081 Natural Amber
- M267-0094 Warm Brown Walnut
- M267-0194 Antique Maple
- M267-0208 Old World Walnut
- M267-0266 Newport Ebonized Cherry
- M267-0337 Golden Oak
- M267-0381 Cherry/Walnut
- M267-0418 Mocha Brown
- M267-0474 Warm Oak
- M267-0477 Natural Maple
- M267-0479 Maple Glaze
- M267-0484 Brown Paprika

## WOOD REPAIR

## MOHAWK

### MOHAWK BRUSH TIP MARKER ASSORTMENT

6 pack assortments

Mohawk Brush Tip Marker 6 Pack Assortments. Markers feature a micro brush-tip applicator to apply color exactly where it is needed without any messy powders, fluids or odors. Simple and easy to use, this wood graining marker applies color to imitate the natural grain appearance of wood surfaces after minor repairs. Low to no odor, easy to use.



- Use to add grain lines or alter color after application of putty sticks
- Add color to small sand thru areas on a face or edges of a wooden part
- Add or alter color in any small defect

**Marker Asst #1** Includes:

- 2000 - Raw Umber
- 2001 - Dark Cherry
- 2002 - Perfect Brown
- 2003 - Dark Perfect Brown
- 2004 - Honey Spice
- 2005 - Marker Black

**Marker Asst #2** Includes:

- 2006 - Light Oak
- 2007 - Van Dyke Brown
- 2008 - Dk Brown Mahogany
- 2009 - Burnt Umber
- 2010 - Burnt Sienna
- 2011 - Deep Brn Mahogany

**Marker Asst #3** Includes:

- 2012 - Ash Tone
- 2013 - Honey Maple Tone
- 2014 - Wrm Brn Walnut Tone
- 2015 - Golden Oak Tone
- 2016 - Deep Cordovan
- 2017 - Nat Light Oak Tone

**Marker Asst #4** Includes:

- 2018 - Warm Oak Tone
- 2019 - Maple Glaze Tone
- 2020 - Med Dark Oak Tone
- 2021 - Lt Golden Oak Tone
- 2022 - Nutmeg Tone
- 2023 - Antique Maple Tone

Code	Description	List/pk
M265-2201	Brush Tip Marker Asst #1	\$ 69.87
M265-2202	Brush Tip Marker Asst #2	69.87
M265-1203	Brush Tip Marker Asst #3	69.87
M265-1204	Brush Tip Marker Asst #4	69.87

### MOHAWK BACKGROUND MARKER TOUCH UP

12 Marker Assortment

Dispenses a thin, highly opaque, fast drying, low sheen film to replace background color over fills, glue lines, dark areas in raw wood, and other stains. Touch up on MDF, particle-board, and other very absorbent substrates, which go dark with other types of markers.

**M294-1210**

Marker Assortment

Contains 12 gray colors



Code	Description	List/pk
M294-1210	12 Marker Assortment	\$ 129.52

### MOHAWK ULTRA MARK MARKERS

Touch-up furniture defects instantly! Contains light-fast pigments which seal, stain and finish. Ideal for edge and scratch recoloring. Use in conjunction with Mohawk Fil-Stik® Putty Sticks and E-Z Flow™ Burn-In Sticks. For further protection, can be sprayed over with Tone Finish Clears.

**M280-1210**

Gray Assortment



Code	Description	List
M280-1210	Ultra Mark Gray, 12 pc asst.	\$ 126.48 /pk
M280-0202	Single Marker, White S8	12.95 /ea





MOHAWK

PUTTY STICKS

MOHAWK FIL-STIK™ PUTTY STICKS

Semi-hard putty sticks used to fill in nicks and scratches or open corner joints. No heat or special tools required, simply rub in and wipe off. Can be top coat protected with Tone Finish® aerosols or other coatings.



M230-2400

Marker Assortment

Contains 24 colors

M230-2400 contains one of each:

0401 Almond	0411 Nutmeg
0224 Black	0333 Oak Heritage
0408 Cherry	2052 Oak Medium
9839 Rustic Cherry	0206 Walnut Light
0300 Fontana	0207 Walnut Med Brwn
L404 Fruitwood Light	0358 Walnut Dark
0115 Mahogany Deep	0209 Walnut Extr Drk
0218 Mahogany Lt Red	0202 White
9838 Mahogany Old World	1506 White Provincial
0237 Maple Med Rock	0331 Pickle Frost
0100 Natural	1516 Pine
0102 Natural Tone	0504 Pine Winter

<u>Code</u>	<u>Description</u>	<u>List/st</u>
M230-2400	24 Marker Assortment	\$ 116.40

Individual Fil Stik Putty Stiks



<u>Code</u>	<u>Description</u>	<u>List/ea</u>
M230-0100	1 ea. Natural	\$ 5.06
M230-0202	1 ea. White	5.06
M230-0334	1 ea. Off-White	5.06
M231-8226	1 ea. Black	5.06
M231-8618	1 ea. White Arctic	5.06
M231-9033	1 ea. Newport Ebonized Cherry	5.06

MOHAWK FIL-STIK™ PUTTY STICKS cont.

M230-1230

Light Gray Assortment



M230-1240

Med/Dark Gray Assortment

Light Gray Asst

- 0104 Clay
- 0029 Gray Maple
- 0036 Repose Gray
- 0047 Fashion Gray
- 0055 Crystal Fog
- 0110 Moonshine
- 0113 Pebble Gray
- 0114 Pebble Gray Glaze
- 0122 Modern Gray
- 0128 Platinum
- 11858 Rag and Bone UC
- 11860 Lunar Gray UC

Med/Dk Gray Asst

- 0005 Sharkfin
- 0006 Silverado
- 0017 Slate/Morel
- 0033 Gray Wolf
- 0035 Gun Metal Gray
- 0057 Platinum Gray
- 0066 Blue Ridge
- 0103 Flagstone
- 0027 Nebulous Gray
- 0135 Dovetail
- 11707 Storm Gray on Red Birch
- 11708 Storm Gray on Alder

<u>Code</u>	<u>Description</u>	<u>List/st</u>
M230-1230	Light Gray 12 pc asst.	\$ 58.23
M230-1240	Med/Dk Gray 12 pc asst.	58.23

## WOOD REPAIR

### MOHAWK EPOXY STICKS

Mohawk's Wood Epoxy Putty Stick enables you to restore, rebuild and repair all kinds of wood and other hard surfaces.



- Easy to use
- Makes durable, permanent repairs
- 3-5 minute workable time
- Fast curing, hardens in less than 20 minutes
- No shrinkage - molds to any shape
- May be sanded, drilled, stained or painted
- Adheres well to wood, metal, glass and ceramic

Pack: 12 ea. 7" long, 7/8" dia, 2.7 oz. net wt.

Code	Color	List/ea
M743-1500	Beige	\$ 17.59
M743-1510	Pine	17.59
M743-1520	White	22.02
M743-1530	Oak/Light Walnut	22.02
M743-1540	Mahogany	22.02
M743-1550	Cherry	22.02
M743-1560	Walnut	22.02
M743-1570	Black	22.02
M743-1575	Natural Oak	22.02
M743-1580	Natural Maple	22.02
M743-1585	Natural Cherry	22.02
M743-1590	Raw Umber	22.02

### SOFT WAX FILLER SYSTEM

FastCap



Fill the hole with wax



Remove excess wax



Buff with pad

Replacement/Refill items:



White Softwax Refill #01



Wax Wedge



Buffing Pad

Softwax, by Fastcap, is a great way to fill holes! These easy to use wax filler sticks make touch ups and repairs quick and simple. The hard shell case keeps your wax organized and clean. Kit includes 20 colors (blend colors to match just about anything), wax wedge and buffing pad. Refills are available in all colors.

Code	Description	List/ea
WAXKIT.20S	Wax Filler Kit	\$ 55.05
WAX01S	White Softwax Refill	4.26
WAXBUFFPAD	Buffing Pad	2.38
WAXWEDGE	Wax Wedge	2.38



## WOOD FILLER

### FAMOWOOD WOOD FILLER

An all purpose wood filler. It is waterproof and non-shrinking. Dries quickly. Also for marine use. Sands easily to the desired finish. Takes spirit dye stains freely.



12 each/ctn.

<u>Color</u>	<u>6 oz./ \$ 5.50 ea.</u>	<u>23 oz./ \$ 11.81 ea</u>
Alder	32 ALD	8 ALD
Ash	32 ASH	8 ASH
Birch	32 BIR	8 BIR
Cedar	32 CEDAR	8 CEDAR
Fir/Pine	32 FIR	8 FIR
Mahogany	32 MAH	8 MAH
Maple	32 MAP	8 MAP
Natural/Tupelo/ White Pine	32 NAT	8 NAT
Oak	32 OAK	8 OAK
Red Oak/Cherry	32 ROAK	8 ROAK
Walnut	32 WAL	8 WAL
White	32 WHI	8 WHI

### SOLVENT FREE FAMOWOOD

Water-based Famowood. Performs like regular Famowood with exceptionally high solids content. Won't crack, shrink, or crumble.



You can paint or stain it - anything you would do to ordinary wood. Non-toxic and non-flammable. Cleans easily with water prior to drying. Approx 15 min. dry time. Contains wood flour.

24 oz. tubs. 12 each/ctn.

<u>Code</u>	<u>Wood</u>	<u>List/ea</u>
16BIR-SF	Birch	\$ 10.04
16GOAK-SF	Golden Oak	9.68
16MAP-SF	Maple/Fir	10.06
16NAT-SF	Natural	10.02
16OAK-SF	Oak	9.66
16ROAK-SF	Red Oak	9.64
16WAL-SF	Walnut	9.66
16WHI-SF	White	9.66
16MAH-SF	Dk Mahogany/Cherry	8.97
16PINE-SF	Pine	8.94

### MOHAWK WOOD FILLER

A water-based premium grade, solvent free filler that sets firmly to all wood surfaces. Offers minimal shrinkage and will not crack or fall out. Accepts most stains, tints or finishes and all finishing operations; painting, staining, sanding, drilling, sawing and lacquers. Ideal for edge veneering and woodgrain filling.



Quick drying, easy clean-up. 16 oz. tubs.

<u>Code</u>	<u>Description</u>	<u>List/ea</u>
M741-0025	Alder/Cherry, 16 oz.	\$ 14.02
M741-0035	Natural Maple, 16 oz.	14.02

### 3M BONDO

Lightweight polyester body filler cures tack-free in 15 to 20 minutes. The creamy texture spreads smoothly and is easy to sand. Vacuum processed to minimize pinholing. Comes with a tube of blue creme hardener.



<u>Code</u>	<u>Size</u>	<u>Ctn</u>	<u>List</u>
05800	Quart	6 ea	\$ 31.65
05801	Gallon	4	65.66
05766	Extra Creme Hardener	12	14.00



## WOOD REPAIR

## MOHAWK

### MOHAWK BLENDAL™ STICKS

#### **M340-1200**

12 stick assortment  
(0000-0011 colors)

#### **M340-1202**

12 stick assortment  
(0012-0025 colors)



Mohawk Blendal™ Sticks are used to add or alter color when repairing and touching up wood. Allows quick color replacement on raw or finished edges and flat surfaces. For one-step matching, blend the colors to accomplish a perfect match. Then, top coat with a clear aerosol.

To layer color, draw streaks of background, smear lightly & top coat. Repeat with a foreground color, then a grain color, sealing each with a clear top coat.

Code	Contains	List/st
M340-1200	M340-0000 to 0011	\$ 110.52
M340-1202	M340-0012 to 0025	110.52
M340-0011	White	10.28

M340-1200 contains one each of:

0000	Raw Sienna	0006	True Brown
0001	Ginger Brown	0007	Burnt Sienna
0002	Harvest Brown	0008	Mahogany
0003	Burnt Umber	0009	Cordovan
0004	Heritage Cherry	0010	Black
0005	Raw Umber	0011	White

M340-1202 contains one each of:

0012	Beige Tone	0020	Van Dyke Brown
0013	Rock Maple	0021	Honey Maple
0015	Wheat	0022	Lt Red Mahogany
0016	Cinnamon	0023	Natural Maple
0017	Cayenne	0024	Pale Gold
0019	Natural Oak	0025	Yellow

### MOHAWK PATCHAL™ PUTTY

Patchal™ Putty is designed to be used on finished wood to fill nail holes, miter joints and cabinet seams. Great for picture frames, trim and molding.

- Fast and easy application
- Simple clean up
- Can be top coated within minutes
- Superior color selection matched to current industry trends
- Easy to open lid keeps putty fresh
- Color labels on the lids make it easy to find the right color



#### Individual 4.4 oz. containers

Code	Color	List/ea
M734-0001	Black	\$ 15.95
M734-0002	White	15.95
M734-0007	Cherry	15.95
M734-0013	Hickory	15.95
M734-0015	Extra Dark Walnut	15.95
M734-0017	Natural Oak	15.95
M734-0018	Natural Maple	15.95
M734-0020	Raw Sienna	15.95
M734-0022	Honey Spice	15.95
M734-0023	Natural Maple Laminate	15.95

#### 24 Pack Assortment

M734-2400	Assorted Colors	\$ 538.42
-----------	-----------------	-----------

Includes one each of the following:

0001	Black	0013	Hickory
0002	White	0014	Mocha
0003	Beige Tone	0015	Extra Dark Walnut
0004	Light Red Mgny	0016	Van Dyke Brown
0005	Cordovan	0017	Natural Oak
0006	Wine	0018	Natural Maple
0007	Cherry	0019	Ginger
0008	Warm Cherry	0020	Raw Sienna
0009	Rock Maple	0021	Nutmeg
0010	Cinnamon	0022	Honey Spice
0011	Natural Cherry	0023	Nat Maple Lam.
0012	Burnt Sienna	0024	Fawn

17



## WOOD FILLER

### TIMBERMATE WOOD FILLER

Interior Waterbase Wood Putty

- Won't shrink, crack or fall out
- Takes every stain and coating
- Mixes with any oil or waterbase stain
- Freeze and thaw stable
- No waste - easily reconstituted when dry
- Saws, sands and drills when dry



8 oz. containers



4 lbs.

- Designed for interior use
  - Seal with finish top coat(s) to cure surface and protect from water
  - Putty is silica based. Colorants are light-stable, ferrous metal oxides
- \* Use plastic or stainless putty tools to prevent ferrous metallic tool stains.

Size	Ctn	List/ea
8 oz.	12 ea.	\$ 12.08
4 lbs.	1 ea.	28.27

8 oz.	4 lbs.	Species
AMB25	AMB2	Maple / Beech
BB25	BB2-TM	American Cherry
ABC25	-	Brazilian Cherry*
ARO25	ARO2	Red Oak*
AW25	AW2	Walnut
AWO25	AWO2	White Oak*
AAM25	-	Mahogany
ALD25	-	Alder
AE25	-	Rustic Ebony
ATB25	ATB2	Natural/Tint base
TAO25	-	Tasmanian Oak
AWH25	AWH2	White
AAC25	-	Teak / Heart Pine

### COLOR PUTTY

For Woodworking or Paneling



1 lb. Jars

3.68 oz.

#### Easy to use!

1. Stain (if necessary). Do not use on bare wood.
2. Seal or varnish.
3. Fill nail holes and imperfections with matching Color Putty. You may intermix Color Putty for desired shade.
4. Apply one finish coat of seal or varnish (except epoxy).

Note: Try test sample of wood or paneling before using Color Putty. Not recommended for table tops or floors. Does not dry to sandable hardness.

Size	Ctn	List/ea
3.68 oz. Jars	6 ea.	\$ 5.09
1 lb. Jars	12 ea.	13.27

3.68 oz.	1 lb.	Species
CP100-368	CP100-1	White
CP106-368	CP106-1	Light Birch
CP108-368	-	Light Oak
CP110-368	-	Fruitwood
CP116-368	-	Butternut
CP118-368	CP118-1	Cherry
CP124-368	-	Redwood
CP126-368	CP126-1	Br. Mahogany
CP130-368	CP130-1	Dark Walnut
CP134-368	-	Ebony
CP136-368	-	Nutmeg
CP138-368	-	Pecan
CP140-368	-	Briarwood
CP144-368	-	Teakwood

### MEAN STREAK FIL-STIK

For Melamine



85018

Waterproof Permanent Marking Fil-Stik. Fills and repairs melamine chip-outs, nail holes and nicks. Glides on, then dries and hardens within 5 minutes. Solves a lot of finish problems FAST!

Code	Description	Ctn	List/ea
85018	Wht Melamine Fil-Stik	12 ea.	\$ 10.42

### WOOD REPAIR SOLVENT

Rejuvenate thickened putty which has lost its pliability due to solvent evaporation. A small amount of solvent is all that is needed to return the putty to its original viscosity. 16 oz. (pint) size.



Code	Description	List/ea
M740-2005	Wood Repair Solvent, One Pint size	\$ 23.85



WOOD STAINS

MOHAWK

MOHAWK ULTRA PENETRATING STAIN™

A truly new dye type stain that offers superior transparent qualities found only in dye stains. Excellent lightfastness; fade and UV resistant on interior wood. Will not bleed into most solvent-borne top coat finishes.

May be brushed or sprayed directly on wood or mixed in lacquer for toning. May be used as base or for under wood tone wiping stain. Colors may be intermixed to create additional shades. Ultra Penetrating Stain™ offers the best combined characteristics of water, alcohol, or lacquer type dyes.

7 follows product code for Gallon sizes, 6 follows code for Quart sizes. 120 VOC compliant. Greenguard.



1 Gallon



1 Quart



M520-01A4 Jet Black



M520-203 Yellow



M520-205 Mustard



M520-206 Light Walnut



M520-207 Medium Brown Walnut

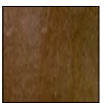

M520-209 Extra Dark Walnut



M520-218 Light Red Mahogany

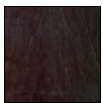

M520-224 Black



M520-227 Dark Red Mahogany



M520-229 Brown Mahogany



M520-234 Medium Dark Walnut



M520-236 Brown Maple



M520-238 Orange



M520-240 Colonial Maple



M520-242 Red



M520-245 Oxblood



M520-249 Perfect Brown



M520-273 Modern Mahogany



M520-337 Golden Oak



M520-386 Medium Mahogany



M520-408 Cherry



M520-413 Green



M520-414 Blue



M520-415 Light Golden Oak



M520-476 Burnt Sienna



M520-477 Raw Sienna



M520-0143 Raw Umber



M520-0205 Medium Walnut



M520-1435 Burnt Umber



M520-1478 Van Dyke Brown



M520-2046 Lemon Yellow

Quart

- M520-2036
- M520-2056
- M520-2066
- M520-2076
- M520-2096
- M520-2186
- M520-2246
- M520-2276
- M520-2296
- M520-2346
- M520-2366
- M520-2386
- M520-2406
- M520-2426
- M520-2456

Gallon

- M520-2037
- M520-2057
- M520-2067
- M520-2077
- M520-2097
- M520-2187
- M520-2247
- M520-2277
- M520-2297
- M520-2347
- M520-2367
- M520-2387
- M520-2407
- M520-2427
- M520-2457

Color

- Yellow
- Mustard
- Light Walnut
- Med. Brn. Walnut
- Extra Dark Walnut
- Lt. Rd. Mahogany
- Black
- Dk. Rd. Mahogany
- Brown Mahogany
- Md. Dark Walnut
- Brown Maple
- Orange
- Colonial Maple
- Red
- Oxblood

Quart

- M520-2496
- M520-2736
- M520-3376
- M520-3866
- M520-4086
- M520-4136
- M520-4146
- M520-4156
- M520-4766
- M520-4776
- M520-01436
- M520-02056
- M520-14356
- M520-14786
- M520-20466
- M520-01A46

Gallon

- M520-2497
- 
- M520-3377
- M520-3867
- M520-4087
- M520-4137
- M520-4147
- M520-4157
- M520-4767
- M520-4777
- M520-01437
- M520-02057
- M520-14357
- M520-14787
- M520-20467
- M520-01A47

Color

- Perfect Brown
- Mod. Mahogany
- Golden Oak
- Med. Mahogany
- Cherry
- Green
- Blue
- Lt. Golden Oak
- Burnt Sienna
- Raw Sienna
- Raw Umber
- Med. Walnut
- Burnt Umber
- Van Dyke Brown
- Lemon Yellow
- Jet Black

Ultra Penetrating Stain

- Quarts: 4 per carton
- Gallons: 2 pails per carton

List \$ 48.35 ea. 107.67

M900-1002\*

Stain Deck Wood Color Chips

\$ 105.32

## MOHAWK

## WOOD STAIN

### SEAL & STAIN™ PRE-STAIN/CLEAR STAIN BASE

Use as a pre-stain treatment of wooden surfaces to reduce blotchy areas in soft woods before staining. Apply by spray, brush or rag liberally over entire surface and remove excess by wiping with a cloth. Allow to dry 15-30 minutes before applying any stain color. May also be added to any wiping stain to reduce color intensity.



Code	Size	List/ea
M545-0107	116 oz.	\$ 107.67

### PAINT STRAINERS

Strong, durable cone-shaped construction. 250/ pack.



Ideal for removing unwanted dust and other impurities from small quantities of paint. Made with synthetic mesh for more accurate pore sizes, better filtration of paint, and faster straining. Medium mesh strainers work on latex or oil based paints, and fine mesh strainers are especially suited for all lacquers and enamels.

Code	Description	List/pack
11105-250	Med. mesh paint strainer	\$ 80.00
11107-250	Fine mesh paint strainer	80.00

### STAINING PAD

Ideal for applying stain to any surface without drips or blemishes. Uniquely composed of two layers: the terry cloth cover is soft and absorbent, while the inner sponge soaks up excess liquid to prevent drips and running.



Code	Description	List/ea
10101B	Staining Pad	\$ 2.75

### FINISHER'S GLAZE™ GLAZING STAIN

A truly new glazing stain. Features a super concentrated colorant in a medium viscosity base. Unique combination of resins provide excellent adhesion between the sealer, glaze and topcoat. Colors can be intermixed to achieve a variety of new shades.



Quart size

Compatible for use with conventional and modern catalyzed finishes as well as conversion varnishes and urethanes. Size: 1 Quart.

Code	Color	List/ea
M504-2026	○ White	\$ 48.35
M504-2246	● Black	48.35
M504-2276	● Dark Red Mahogany	48.35
M504-4766	● Burnt Sienna	48.35
M504-4776	● Raw Sienna	48.35
M504-01436	● Raw Umber	48.35
M504-14356	● Burnt Umber	48.35
M504-14786	● Van Dyke Brown	48.35
M504-0006	○ Clear	48.35

### FINISHER'S GLAZE™ STAIN ASSORTMENT

- Raw Umber
- Burnt Umber
- Raw Sienna
- Burnt Sienna
- Van Dyke Brown
- White
- Black
- Clear



Glazing kit contains 8 jars (4 oz. each) of the most popular basic colors. Each of these shades can be mixed to help produce the desired color. Add richness and color depth to your final finish. Glazing has many different uses:

- Use to get a desired effect or to help produce a certain color
- Produces attractive alternatives to just plain stains and lacquers
- Use as a stain; wipe or brush over sealer

Code	Description	List/asst
M504-1200	Stain assortment	\$ 165.07



## STAINS & COLORANTS

## MOHAWK

### BASE CONCENTRATE PIGMENTED STAIN COLORANT

A finely ground pigment in a high viscosity liquid form, free of fillers and extenders. Recommended for making Wiping Wood™ Stains, Heavy Body Glazing Stain, Shading Lacquer and Tinting Lacquers. This pigmented colorant will mix with lacquer thinner, lacquer, glaze, lacquer sealers and synthetic finishes. Not recommended for water reducible, shellac or alcohol based coatings. Size: One Quart.



Recommended Reducing Proportions:

- Wiping Stains - 20% Colorant and 80% Reducer S15
- Glazing Stains - 20% Colorant and 80% Clear Heavy Body Glaze
- Shading & Tinting Lacquers
  - Add 1 to 3 oz. color per gallon of lacquer

<u>Code</u>	<u>Color</u>	<u>List/ea</u>
M500-01436	Raw Umber	\$ 107.67
M500-14356	Burnt Umber	107.67
M500-14786	Van Dyke Brown	107.67
M500-2026	White	107.67
M500-2246	Black	107.67
M500-4776	Raw Sienna	107.67

### BLEACHTONE™ PICKLEFROST/WHITEWASH

Bleachtone™ is a unique product that is used to create the popular pickle-frost look. Achieve a transparent layer of color on maple that does not block out the grain. White in color but can be tinted.



Can be sprayed directly onto the wood or added (no more than 40%) to E-Z Vinyl® Sealer for improved color control. Glaze can be applied over Bleachtone™ to create a variety of popular looks. Reducer is used to control intensity - use in limited amounts, 4 parts reducer to 1 part Bleachtone.

<u>Code</u>	<u>Description</u>	<u>List/ea</u>
M550-2027	Bleachtone, 1 Gal.	\$ 107.67
M550-2227	Beachtone Reducer	108.61

### M603 FINISH-UP™ POLYURETHANE

Wipe-on, Low odor, Waterbase.



- On site finish repair
- Easy wipe on application
- Good flow characteristics
- Quick drying
- Good durability
- Moisture & alcohol resistant
- Water clear
- Low VOC
- Excellent adhesion
- Nonflammable

A user friendly wipe-on finish. Finish Up™ Polyurethane can be applied over repairs such as Burn-ins, Fil-Stik™ Putty Sticks, Blendal™ Powders and Touch Up Markers to seal in the repair, leaving a durable protective finish.

Can be applied over properly cleaned existing finishes to improve appearance and durability. Finish up™ Polyurethane adheres well to most types of lacquers, vinyl clads, high pressure laminates as well as many other substrates. Water based and has almost no odor.

<u>Code</u>	<u>Description</u>	<u>List/ea</u>
M603-4206	Finish Up, Satin, 1 Quart	\$ 101.66

### M830 PLUSH™ FURNITURE CLEANER AND RESTORER

Cleans and maintains the original sheen of a finish. Helps to prevent printing and dries completely free of oily residue. Recommended as a general prep cleaner and preservative for all finished surfaces. Does not contain silicones.



One Gallon size.

<u>Code</u>	<u>Description</u>	<u>List/ea</u>
M830-2007	Furniture Cleaner, 1 Gallon	\$ 63.83





## STAIN MARKER

### MOHAWK BRUSHES

#### Red Sable Art and Graining Brushes

Excellent touch up brush for spot touch up work and graining. Red sable bristles, tapered to a fine point.



Code	Description	List/ea
M901-1271	Graining brush, 127-1	\$ 10.72
M901-1272	Graining brush, 127-2	12.40
M901-1276	Graining brush, 127-6	26.82
M901-4910	Art brush, 149-1	12.40
M901-4970	Art brush, 149-7	22.29

### MOHAWK STIR STICKS

12" & 21" sizes



Code	Description	List/ea
Z115-4030	12" Stir Stick, PFS	\$ .10
Z115-4031	21" Stir Stick, PFS	.15

### 3M TACK CLOTH



3M™ Wood Refinishers Tack Cloth removes dust, dirt, lint and other particles that settle on wood surfaces. Use it to prepare surfaces before applying the first coat of stain, finish or sealer and again between coats to obtain a super smooth finish.

Code	Description	List/ea
10132NA	Tack Cloth, 17" x 36"	\$ 5.00

### PERFECT MATCH STAIN MARKER

Use your own stain to achieve a perfect match! Touch up custom stained cabinetry, molding, floors or any stainable wood product.



Perfect Match Stain Marker is all you need for touch up. Just add your own water, oil or lacquer based stain and follow the instructions for a perfect match! Use to touch up scratches, nicks, nail holes and imperfections on your wood. Perfect for cabinet installers and finishers. Holds up to 7.5ml, 1/4 fl oz.

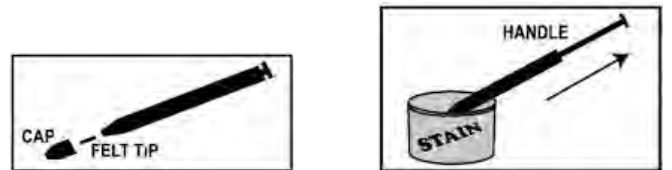

1) REMOVE cap and felt tip



2) Place end of marker in stain. Pull handle until fully extended to fill with stain.

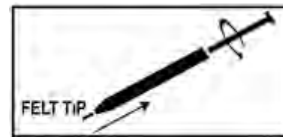

3) UNSCREW handle in a counter-clockwise motion, discard handle, insert felt tip into opposite end.



4) SHAKE marker to agitate stain. Depress tip gently on to scrap of wood or paper until stain begins to flow.

Code	Description	List/pack
PMSM-01	Single Marker	\$ 10.00
PMSM-04	4-Pack Markers	30.02
PMSM-TIPS	5 pcs. replacement tips	3.49



## LACQUERS & SEALERS

## MOHAWK

### MOHAWK WATERBORNE PRE-CATALYZED LACQUER

A freeze-thaw stable formula that is water reducible, self cross-linking, low VOC technology that has excellent color retention and is suitable for cabinet, millwork, furniture and other high traffic interior wooden surfaces. It passes all KCMA performance standards and can be used as a self sealing system.



An environmentally friendly alternative to comparable solvent base products. May be applied over any Mohawk stain. Allow oil type stains to dry a minimum of 1 hour for improved adhesion. Solids: 35%.

- Water-clear product, will not change the color when applied over a color coat
- Improved flow and lay out on the surface due to having more open time
- Suitable for LEED® credits: EQ Credit 4.2 Low Emitting Materials - Paints & Coatings
- Contains no formaldehyde or isocyanate, low odor, water clean up

Code	Finish	Size	List/ea
M640-21207	Matte	1 Gallon	\$ 96.38

Sealer and other sheens available special order.

### BOX OF FINISHING RAGS



Reclaimed clean, washed white T-shirt cotton knit. Low lint. Domestic.

S702-10: 10 lb. Box  
S702-50: 50 lb. Box

Sold in 10 and 50 lb. boxes. Rags range in size, most are approx. 12" x 24" to 21" x 24".

Code	Description	List/bx
S702-10	10 lb. box of reclaimed rags	\$ 49.95
S702-50	50 lb. box of reclaimed rags	215.00

### E-Z VINYL SEALER

A professional grade, high solids formula designed for high contact areas where durability, water resistance, and adhesion are critical. A key advantage is improved system flexibility.



When properly applied under Mohawk pre-catalyzed or post-catalyzed systems, E-Z Vinyl™ passes or exceeds KCMA testing. No Catalyst needed. Ready to spray (RTS) high solids-low viscosity formula. Enables users to achieve the best flow and build without reduction. Meets AWI TR-1 standards. 24% solids. 275 or 550 VOC Compliant.

Code	VOCs	Size	List/ea
M610-8008	550	5 Gallon	\$ 307.12
M610-8007	550	1 Gallon	72.75
M612-8008	275	5 Gallon	378.99

E-Z Vinyl Sealer Aerosol M102-8000 also available. See page 1732 for details.

### E-Z VINYL WHITE SEALER

This high solids, ready to spray, white vinyl primer has excellent moisture resistant characteristics.



When topcoated with Mohawk's DuraCoat™ Pre-Catalyzed White or Ultra™ White Conversion Varnish, the system will pass KCMA testing. It's the perfect choice for priming cabinets, millwork and MDF. Exceptionally user friendly. Solids 41%. Meets AWI Code TR-1 standards. 275 or 550 VOC Compliant.

- Easy to use, builds and dries fast
- Exceptional hiding qualities
- Promotes adhesion with Pre-Catalyzed and Conversion Varnish Topcoats.

Code	VOCs	Size	List/ea
M610-1068	550	5 Gallon	\$ 413.08
M610-1067	550	1 Gallon	90.76
M612-1068	275	5 Gallon	425.39



## MOHAWK

## LACQUER

### PRE-CATALYZED CLEAR LACQUER

The DuraCoat™ 550 VOC is pre-catalyzed, the 275 VOC is post-catalyzed (use with M612-3017 catalyst). A premium quality finish for furniture, cabinets and millwork.



25% solids, moisture resistance, good flexibility and mar resistance. Much more durable than regular nitrocellulose lacquers. When used over our vinyl or high solids pre-catalyzed sealers, DuraCoat produces an exceptional finish system for furniture and passes KCMA testing. Low VOC.

### 550 VOC Pre-Cat

<u>5 Gallon</u>	<u>Finish</u>	<u>Sheen</u>	<u>List/ea</u>
M610-24808	Gloss	80	\$ 335.00
M610-24608	Semi-Gloss	60	335.00
M610-24408	Satin	40	335.00
M610-24208	Matte	20	335.00
M610-24108	Dead Flat	10	335.00

### 1 Gallon

M610-24807	Gloss	80	75.42
M610-24607	Semi-Gloss	60	75.42
M610-24407	Satin	40	75.42
M610-24207	Matte	20	75.42
M610-24107	Dead Flat	10	75.00

### 275 VOC Post-Cat : Needs Catalyst M612-3017

### 5 Gallon

M612-34408	Satin	40	\$ 404.39
M612-34208	Matte	20	404.39
M612-34108	Dead Flat	10	404.39

### 1 Gallon

M612-34607	Semi-Gloss	60	86.03
M612-34407	Satin	40	86.03
M612-34207	Matte	20	86.03
M612-34107	Dead Flat	10	86.03

### LACQUER REDUCER 2255

Formulated with only the highest quality solvents. The special blend helps prevent orange peel and helps provide good flowout.

Recommended for use with all Mohawk Nitrocellulose Lacquers.



<u>Code</u>	<u>Size</u>	<u>List/ea</u>
M650-0108	5 Gallon pails	\$ 293.92

### PRE-CATALYZED WHITE LACQUER

For furniture, kitchen or bath cabinets, DuraCoat™ White topcoats offer high opacity and excellent coverage. When used over the E-Z Vinyl™ White Primer, the system passes KCMA tests. Solids 29%. Meets AWI TR-2 standards.



- No catalyst needed
- Stir and spray
- Resists yellowing
- Durable
- Mar resistant
- Fast dry

### 550 VOC Pre-Cat

<u>Code</u>	<u>Finish</u>	<u>Sheen</u>	<u>Size</u>	<u>List/ea</u>
M610-6408	White Satin	40	5 Gal.	\$ 413.08
M610-6407	White Satin	40	1 Gal.	90.76
M610-6208	White Matte	20	5 Gal.	413.08
M610-6207	White Matte	20	1 Gal.	90.76

### ULTRA WHITE CONVERSION VARNISH Post Catalyzed

Maximum protection against moisture, wear, and resistance to household chemicals. Contains UV inhibitor to resist yellowing.



Performs in high moisture areas such as kitchen cabinets and vanities. Ultra™ White Conversion Varnish topcoats exceed KCMA test when used over the Mohawk E-Z Vinyl™ White Primer. Must catalyze with M615-7017 Conversion Varnish Catalyst at a rate of 8 oz/gal. Meets AWI TR-4 standards. 69% solids.

- 69% solids, high build
- Maximum durability
- High opacity white
- Spray viscosity

### 550 VOC Post-Cat

<u>Code</u>	<u>Finish</u>	<u>Sheen</u>	<u>Size</u>	<u>List/ea</u>
M615-27807	Gloss	80	1 Gal.	\$ 176.19
M615-27607	Semi-Gloss	60	1 Gal.	176.19
M615-27408	White Satin	40	5 Gal.	781.73
M615-27407	White Satin	40	1 Gal.	176.19
M615-27208	White Matte	20	5 Gal.	781.73
M615-27207	White Matte	20	1 Gal.	176.19

## CONVERSION VARNISH

## MOHAWK

### ULTRA CLEAR™ CONVERSION VARNISH

Post Catalyzed / 275 or 550 VOC

Provides the ultimate high-end interior finish. Exceeds the KCMA Household Chemical Tests. This post-catalyzed water white conversion varnish, when used with conversion varnish sealer, creates a finish system of maximum durability, wear and moisture resistance.



A UV inhibitor is included. Can be sprayed with conventional, airless, HVLP and air-assist airless equipment. Use on kitchen and bath cabinets, laboratory, dormitory, office furniture and display fixtures. Low VOC. Before use, must be catalyzed at a rate of 8 oz. per gallon with M615-701. Ultra Clear™ Conversion Varnishes are high-solids low viscosity formulas that enables users to achieve the best flow and build without reduction. Meets AWI TR-4 standards.

- Ultra clear water white
- Ultra high solids / high build
- 40% sprayable solids
- Ultra durable / moisture resist.
- UV stable
- HAPS free
- 275 or 550 VOC compliant

### 275 VOC Compliant

<u>Code</u>	<u>Finish</u>	<u>Sheen</u>	<u>List/ 5 Gal</u>
M612-28408	Satin	40	\$ 574.11
M612-28208	Matte	20	574.11
M612-28108	Flat	10	574.11

### Sealers

M612-8008	EZ Vinyl Sealer	-	\$ 378.99
M612-1068	EZ Vinyl White	-	425.39

### 550 VOC Compliant

<u>5 Gallon</u>	<u>Finish</u>	<u>Sheen</u>	<u>List/ea</u>
M615-29808	Gloss	80	\$ 523.03
M615-29608	Semi-Gloss	60	523.03
M615-29408	Satin	40	523.03
M615-29208	Matte	20	523.03
M615-29108	Flat	10	523.03

### 1 Gallon

M615-29807	Gloss	80	110.18
M615-29607	Semi-Gloss	60	110.18
M615-29407	Satin	40	110.18
M615-29207	Matte	20	110.18
M615-29107	Flat	10	110.18

### CONVERSION VARNISH CATALYST

Use with Mohawk Conversion Varnish topcoats, sealers, and primers in order for them to dry and cure properly.



Use with M615-29XXX and M61527XXX Series.

<u>Code</u>	<u>For VOC</u>	<u>Size</u>	<u>List/ea</u>
M615-7014	550	8 oz.	\$ 20.07
M615-7017	550	1 Gallon	147.90

Use with M612-28XXX Series.

M612-7017	275	1 Gallon	195.00
-----------	-----	----------	--------

Use with M612-34XXX Series.

M612-3017	275	1 Gallon	280.00
-----------	-----	----------	--------



## MOHAWK

## SOLVENTS & RETARDERS

### CONVERSION VARNISH REDUCER / RETARDER

Specifically blended for Mohawk conversion topcoats and sealers. It can be used to reduce the viscosity, slow down the drying time or for clean up. Use only the Mohawk Conversion Varnish Reducer/ Retarder to insure compatibility and professional results with the Ultra Clear™ or VersaClad® Conversion Varnish topcoats and sealer.



Warning: This is not a VOC exempt solvent. If an exempt solvent is needed, use Acetone (M650-001) to reduce Mohawk's VOC compliant conversion varnish products at a rate of no more than 20%.

<u>Code</u>	<u>Size</u>	<u>List/ea</u>
M650-1057	1 Gallon	\$ 69.61

### NO BLUSH™ RETARDER

Prevents lacquer from turning white and prevents orange peel. Prevents lacquer from blushing or turning white (a cloudy effect) in humid or cold weather. Helps prevent orange peel caused by too rapid drying of the finish. Add 5% to 10% No-Blush to the lacquer thinner used to reduce lacquer. 1 Gallon size.



<u>Code</u>	<u>Size</u>	<u>List/ea</u>
M716-2407	1 Gallon	\$ 88.55

### FLATTING PASTE

Mohawk's Flattening Paste may be used to reduce the sheen of their nitrocellulose, pre-catalyzed or conversion varnish topcoats. See Mohawk Flattening Paste Product Data Sheet (PDS) for recommended additions to achieve specific sheens.



<u>Code</u>	<u>Size</u>	<u>List/ea</u>
M716-1706	1 Quart	\$ 63.63

### SUPER BLUSH RETARDER

Super Blush™ Retarder is a premium, very slow solvent for use where conditions of extreme high heat and humidity exist. This solvent used in small amounts will enhance the flow and leveling of all Mohawk nitrocellulose, pre-catalyzed lacquer and post-catalyzed lacquer coatings.



- Formulated for high heat and humid conditions
- Eliminate blushing
- Slowest retarding solvent available

<u>Code</u>	<u>Size</u>	<u>List/ea</u>
M716-3407	1 Gallon	\$ 88.55

### FLASH-OFF CONTROL SOLVENT

Used to improve the flow of lacquers and sealers without slowing the drying. Additions of one or two ounces per gallon of lacquer will eliminate overspray roughness in the finish and improve the overall smoothness. Not a blush retarder.



<u>Code</u>	<u>Size</u>	<u>List/ea</u>
M716-5007	1 Gallon	\$ 88.55

### RETARDER FOR LOW VOC COATINGS

Retarder for Low VOC Coatings is ideal for extending the flow out and open time of Low VOC, solvent based coatings and stains in high heat and humid environments. Retarder for Low VOC Coatings is a blend of VOC exempt solvents that will not affect the total VOC content of a product.



<u>Code</u>	<u>Size</u>	<u>List/ea</u>
M612-1047	1 Gallon	\$ 124.08

## SOLVENTS & REDUCERS

## MOHAWK

### ULTRA PENETRATING STAIN REDUCER

Reducer for Ultra Penetrating Stain reduces the intensity of any color. Reducer can be mixed in any proportion with the colored stain.

120 VOC compliant.



Code	Size	Ctn	List/ea
M520-00017	1 Gallon	2 ea.	\$ 67.82

### MOHAWK POUR-N-WIPE™ FINISH Polyurethane Finish

An alternative to brush or spray finish application. A versatile finish with applications in finishing, refinishing and restoration work. Imparts a satin sheen, protecting wood against alcohol and water staining and is very mar resistant.

- Wipes on as easily as furniture polish!
- Provides a tough, alcohol resistant polyurethane finish
- Apply with a cloth or by a 'squeegee' for large surfaces
- Pour-N-Wipe™ finish is self sealing.



Code	Size	Ctn	List/ea
M603-3017	1 Gallon	2 ea.	\$ 145.60

### MOHAWK ACETONE

Acetone is considered an exempt VOC. It is a strong, fast evaporating solvent used for thinning and cleaning lacquers and adhesives. Acetone is very flammable, and should be used only with adequate ventilation.

May be used as needed for reducing some stains and finishes and as a general cleaner. Acetone will not contribute any additional VOCs to products.



Code	Size	List/ea
M650-0018	5 Gallon	\$ 293.92
M650-0017	1 Gallon	67.82

### MOHAWK CLEAN-UP SOLVENT

Reclaimed Acetone

Mohawk Clean-Up Solvent is reclaimed solvent that contains a high percentage of acetone. It is suitable for effectively cleaning spray guns, brushes and other finishing equipment.



Do not use Clean-Up Solvent to thin or reduce any Mohawk coating or stain. Due to the reclaimed nature of this product the solvent color and odor may vary slightly from batch to batch, which does not affect the product's performance.

Code	Size	List/ea
M650-9008	5 Gallon	\$ 156.18

### TWO-MINUTE TOUCH UP BRUSHING SOLVENT

A brushing type clear liquid used with Blendal Powder Stains for spot brush touch-up and coloring edges. Stays wet on the brush, dries in minutes on the repaired surface. A must in every finisher's kit for use in areas where the "padding" method is not practical. Quart size.



Code	Size	List/ea
M441-0006	1 Quart	\$ 42.63

### SHELLAC REDUCER

Shellac Reducer is used to thin or reduce shellac based products, cleans glass and other non-lacquered surfaces. Shellac Reducer may also be used to clean fine bristle brushes after using with shellac based products. One Gallon size.



Code	Size	List/ea
M650-0057	1 Gallon	\$ 67.82

## MOHAWK

## FINISH AEROSOLS

### TONE FINISH CLEARS

Clear Nitrocellulose based lacquers are recommended as topcoats for wood finishes. Provides excellent flow and protection on repairs.

Net Wt. 13 oz. Pack: 12 each.

Code	Finish	List/ea
M102-0422	Satin	\$ 14.93



### FINISHER'S CHOICE™ CLEARS

A high solids aerosol lacquer that eliminates the need to mix bulk finishes for your small refinishing and restoration jobs. Net Wt. 13 oz. Pack: 12 each.

- Higher Solids
- Outstanding atomization
- Fast build
- Excellent blush resistance
- Superior flow out

Code	Description	List/ea
M102-0543	Sanding Sealer	\$ 14.93



### TONE FINISH TONERS

Finely ground, non-fading pigment for color repairs that last. Used throughout the industry for quick, efficient professional touch-up. Adapts to various methods for blending in spot repairs. Adjustment of sheen is achieved with a topcoat of clear lacquers available in gloss, satin, flat and dead flat.

Net Wt. 13 oz. Pack: 12 each.

Code	Color	List/ea
M101-0249	Perfect Brown	\$ 6.07
M115-1613	Newport - Ebonized Cherry	14.93



### MOHAWK AEROSOL LACQUERS

#### Pre-Catalyzed Clears

Features excellent flowout for touch-up use. The dry film is very durable and adheres where other finishes will not. Has been tested and approved for in-factory touch-up on catalyzed finishes: passes KCMA standards. Nt. Wt. 13 oz. Pack: 12 each.

- Excellent atomization and adhesion
- Very good clarity and durability

Code	Finish	Sheen	List/ea
M102-0410	Gloss	≥75	\$ 11.89
M102-0411	Flat	8-12	14.93
M102-0412	Satin	35-40	14.93
M102-0414	Dead Flat	3-5	14.93
M102-0415	Semi-Gloss	60-65	14.93
M102-0416	Matte	20-25	14.93



### E-Z VINYL SEALER AEROSOL

The choice for spot repairs on kitchen cabinetry, furniture or millwork. Proven durability, moisture resistance and adhesion. E-Z Vinyl Sealer is a water clear, quick build sealer and is designed for use under mid to higher sheen finishes. Provides a flexible, moisture resistant surface when applied under all Mohawk aerosol clear topcoats. Net Wt. 13 oz. Pack: 12 each.

- 42-46 Sheen
- Compatible to use under any Mohawk aerosol topcoat
- Non-Stearated formulation

Code	Description	List/ea
M102-8000	Aerosol Sealer	\$ 14.93



### SUPER BLUSH™ RETARDER

Humidity or cold weather can cause a finish to turn white (blush). Super Blush™ Retarder is a highly effective blush remover aerosol designed for solving the most severe blushing problems. Net. Wt. 13 oz. Pack: 12 each.

Code	Description	List/ea
M103-0476	Aerosol Retarder	\$ 14.93





## FINISH AEROSOLS

## MOHAWK

### COLORED LACQUER ENAMEL

Opaque finish for interior use only. Fast drying, lacquer based enamel. Superior hiding power for producing opaque finishes. Net Wt. 13 oz.



<u>Code</u>	<u>Description</u>	<u>List/ea</u>
M104-S202	White Satin Enamel Lacq	\$ 14.93
M104-F202	White Flat Enamel Lacq	14.93

### PRIMER SEALER

White

Primer coat for use under colored lacquer enamels. Insures good adhesion for the final topcoat. Primer Sealer is fast drying and easy sanding, resulting in a smooth base. Has excellent color strength. Net Wt. 13 oz.



<u>Code</u>	<u>Description</u>	<u>List/ea</u>
M103-0447	Primer Sealer, White, 13 oz. Aerosol	\$ 14.93

### REPLACEMENT SPRAY HEADS

Mohawk



Change spray heads on aerosols to customize the spray pattern, or to replace clogged heads.

<u>Code</u>	<u>Description</u>	<u>List/ea</u>
M120-0210	Heavy Spray	\$ .82
M120-2030	Fan Spray	.82

### WAX WASH™ REMOVER

Removes wax, oil and foreign materials from most surfaces in one application. The presence of these can retard drying or cause defects in finishing topcoats. Prior to applying a new finish or repair, clean surface with Wax Wash™ Remover. Ideal for furniture, appliances, woodwork and other surfaces. Net Wt. 12 oz.



<u>Code</u>	<u>Description</u>	<u>List/ea</u>
M107-0190	Wax-Wash remover, 12 oz. aerosol	\$ 24.72

### OZ® CREAM POLISH

- Antistatic agent for less dusting
- Ultraviolet light absorber to protect the color of the wood
- Lemon scent for a fresh, clean fragrance
- Extended evaporation rate meaning larger pieces can be polished with greater ease
- Lower VOC



The "all-in-one" furniture cream polish in an aerosol! Cleans - polishes - protects. Use on any smooth finish surface such as furniture, tile, marble, cabinets, fixtures, chrome, etc. Non-abrasive, greaseless and quick drying. Net Wt. 13 oz.

<u>Code</u>	<u>Description</u>	<u>List/ea</u>
M107-0860	OZ® cream polish, 13 oz. aerosol	\$ 21.28





### Chemcraft Pre-Catalyzed Products

## LACQUER

Pre-Catalyzed finishes are simple yet versatile. Self-seal, or use with a Chemcraft sealer. Spray straight out of the pail, or add a catalyst for even more resistance. Recommended for office and household furniture, kitchen cabinets, as well as many other interior wood applications.



#### **OPTICLEAR LIGHT 550 CLEAR TOPCOAT**

A one-component high solids, cross-linking coating with very good moisture, household wear, chemical and mar resistance. Dries quickly and sands easily. Can be catalyzed to further enhance durability. Ready to spray.

Meets: KCMA Standards  
Recommended AWI Pre-Cat Lacquer

Weight solids: 24%  
Shelf Life: 6 months

Mixing Ratio: 100 parts 431-85XX to 1 part  
873-1205 (when catalyzed)

Coverage: 250 sq. ft/gal at 1 mil dry. Varies depending on method of application or coating thickness.

#### **550 VOC Pre-Cat**

<u>5 Gallon</u>	<u>Finish</u>	<u>Sheen</u>	<u>List/ea</u>
431-8510-5	Matte	10	\$ 429.94
431-8520-5	Low Gloss	20	432.63
431-8540-5	Satin	40	431.80
431-8560-5	Semi Gloss	60	431.80
431-8590-5	High Gloss	90	431.89
<u>1 Gallon</u>			
431-8520-1	Low Gloss	20	\$ 166.82
431-8540-1	Satin	40	166.82

#### **OPTISEAL 550 CLEAR SEALER**

A one-component high solids, cross-linking easy sanding sealer. Provides excellent sealing properties and very rapid dry. May be catalyzed to further enhance its durability.

Recommended AWI Pre-Cat Lacquer

Weight solids: 24%  
Shelf Life: 6 months

Mixing Ratio: 100 parts 431-1961 to 1 part  
873-1205 catalyst

Coverage: 250 sq. ft/gal at 1 mil dry. Varies depending on method of application or coating thickness.

#### **550 VOC Pre-Cat**

<u>Code</u>	<u>Description</u>	<u>Size</u>	<u>List/ea</u>
431-1961-1	Pre-cat sealer	1 Gal	\$ 166.82
431-1961-5	Pre-cat sealer	5 Gal	399.62

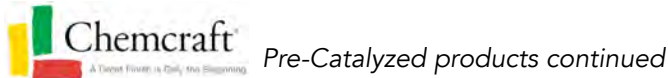

**OPTIPRIME 275 WHITE PRIMER**

A one-component, high solids coating used as a primer for pre-catalyzed or catalyzed systems. Has high build and filling properties, good hiding characteristics and sands to a smooth finish.



Weight solids: 39%  
 Shelf Life: 3 months

Mixing Ratio: 100 parts 545-5900 to 1 part 873-1900 catalyst

**275 VOC Pre-Cat**

Code	Description	Size	List/ea
545-5900-1	Pre-cat primer	1 Gal	\$ 165.97
545-5900-5	Pre-cat primer	5 Gal	583.95

**OPTISEAL 275 CLEAR SEALER**

A one-component high solids pre-catalyzed sealer that provides excellent sealing properties and very rapid dry. Labor saving through the elimination of a coating step or two is generally realized due to the high solids in the product. Meets KCMA standards.



Weight solids: 27%  
 Shelf Life: 3 months

Mixing Ratio: 100 parts 546-5900, 1 part 873-1205 catalyst

Coverage: 332 sq. ft/gal at 1 mil dry. Varies depending on method of application or coating thickness.

**275 VOC Pre-Cat**

Code	Description	Size	List/ea
546-5900-5	Pre-cat sealer	5 Gal	\$ 397.85

**Chemcraft Vinyl Products**

**CHEMVINYL 275 CLEAR SEALER**

A single component vinyl modified nitrocellulose sealer that provides excellent sealing properties and very rapid dry. Developed to improve adhesion and moisture resistance. An easy sanding sealer that shows improved adhesion with various stain systems.



All nitrocellulose lacquers will yellow over time. This could become an issue if this product is used over white surfaces. This yellowing generally adds a warm patina when applied over most other colors and stains.

**Recommended AWI - Nitrocellulose Lacquer System**

Weight solids: 23%  
 Shelf Life: 12 months

Coverage: 262 sq. ft/gal at 1 mil dry. Varies depending on method of application or coating thickness.

Reducer: 800-5500

Retarder: 800-5915

**275 VOC Pre-Cat**

Code	Description	Size	List/ea
546-8900-1	Clear sealer	1 Gal	\$ 166.66
546-8900-5	Clear sealer	5 Gal	405.97

17



Pre-Catalyzed products continued

**LACQUER**

**VARICURE 275 CLEAR TOP COAT**

A one-component high solids, cross-linking pre-catalyzed top coat. Fast building, demonstrates very good moisture, household wear, chemical, solvent and mar resistance. Very fast hardness development resulting in early print resistance and packaging. Dries quickly and sands easily.



Ready to spray. Varicure 275 can be used as a self-seal or over Variseal 275 (431-1701).

Meets KCMA Standards  
 Recommended AWI T.R.2.

Weight solids: 23%  
 Shelf Life: 6 months

Mixing Ratio: 99 parts 431-17XX, 1 part  
 873-1900 catalyst

Coverage: 372 sq. ft/gal at 1 mil dry. Varies  
 depending on method of application or  
 coating thickness.

**275 VOC Pre-Cat**

5 Gallon	Finish	Sheen	List/ea
431-1710-5	Matte	10	\$ 486.16
431-1720-5	Low Gloss	20	486.16
431-1740-5	Satin	40	485.98
431-1760-5	Semi Gloss	60	485.98
431-1790-5	High Gloss	90	485.98
1 Gallon			
431-1720-1	Low Gloss	20	165.86
431-1740-1	Satin	40	166.68

**VARISEAL 275 CLEAR SEALER**

A one-component, cross-linking pre-catalyzed sealer designed to be used with the Varicure 275 system. It dries fast and sands easily to provide a smooth finish. Ready to spray.



Meets KCMA Standards  
 Recommended AWI T.R.2.

Weight solids: 19.9%  
 Shelf Life: 6 months

Mixing Ratio: 99 parts 431-1701, 1 part  
 873-1900 catalyst

Coverage: 227 sq. ft/gal at 1 mil dry. Varies  
 depending on method of application or  
 coating thickness.

**275 VOC Pre-Cat**

Code	Description	Size	List/ea
431-1701-1	Pre-cat sealer	1 Gal	\$ 166.82
431-1701-5	Pre-cat sealer	5 Gal	479.68

**VERSAPRIME 275 WHITE PRIMER**

A one-component, high solids, pre-catalyzed pigmented lacquer used as a primer. Provides chemical resistance along with adhesion over all wood species. The coating is supplied at a ready to spray viscosity.



Weight solids: 43.8%  
 Shelf Life: 3 months  
 Mixing Ratio: 100 parts 545-5120 to 1.75 parts  
 873-1900 (as a post-cat)

Coverage: 445 sq. ft/gal at 1 mil dry and at 100%  
 transfer efficiency.

**275 VOC Pre-Cat**

Code	Description	Size	List/ea
545-5120-5	Pre-cat primer	5 Gal	\$ 643.32

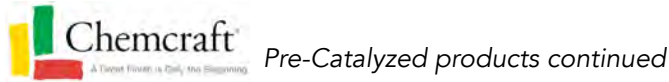

**VARISSET 275 PIGMENTED TOP COAT**

A one-component, pigmented pre-catalyzed coating with very good moisture, household wear, chemical and mar resistance. Dries quickly and sands easily. May be catalyzed to further enhance its durability.



Meets: KCMA Standards  
Recommended AWI Pre-Cat Opaque

- Weight solids: 36%
- Shelf Life: 6 months
- Mixing Ratio: 100 parts 131-17XX to 1 part 873-1900 catalyst
- Reducer: 803-1325 or 803-1349
- Retarder: 800-5815

**275 VOC Pre-Cat Neutral**

<u>5 Gallon</u>	<u>Finish</u>	<u>Sheen</u>	<u>List/ea</u>
131-1720-5	Low Gloss	20	\$ 570.82
131-1740-5	Satin	40	567.91
<u>1 Gallon</u>			
131-1720-1	Low Gloss	20	159.60
131-1740-1	Satin	40	159.60

**OPTISET 550 WHITE PIGMENTED TOP COAT**

A one-component, pigmented pre-catalyzed coating with good resistance properties. Meets the German "E-1" classification for the emission of formaldehyde as tested by an accredited laboratory using North American test methods.



Fast building, demonstrates very good moisture, household wear, chemical and mar resistance. The coating has light stable properties due to the type of resin used. May be catalyzed to further enhance its durability. Optiset 550 has very low odor during the curing process while maintaining its rapid dry and cure properties.

Meets: KCMA Standards  
Recommended AWI O.P.2.

- Weight solids: 49%
- Shelf Life: 6 months
- Mixing Ratio: 100 parts 131-82XX, 1 part 873-1205 catalyst
- Coverage: 575 sq. ft/gal at 1 mil dry. Varies depending on method of application or coating thickness.
- Reducer: 803-1325 or 800-5500
- Retarder: 800-5328

**550 VOC Pre-Cat**

<u>Code</u>	<u>Description</u>	<u>Size</u>	<u>List/ea</u>
131-8240-1	White, Satin Sheen	1 Gal	\$ 135.95
131-8240-5	White, Satin Sheen	5 Gal	455.51



**Chemcraft Post-Catalyzed Products**

**CONVERSION VARNISH**

For lasting performance that's also user-friendly. Perfect for furniture, cabinetry or any wood surface that needs to weather a household storm of cleansers and chemicals. Recommended for office and household furniture, kitchen cabinets, as well as many other high performance interior wood applications.



**COVAR 275 CONVERSION VARNISH CLEAR TOPCOAT**

A two-component coating that is a fast drying, good building product that shows excellent resistance to chemicals and physical wear. Has excellent leveling and a smooth, even appearance, even on open-grain woods. Sands easily and can be used as a self seal finish. Ready to spray. Very low HAPs and very low VOC.

Meets KCMA Standards, AWI 8th Ed.

- Weight solids: 33%
- Shelf Life: 6 months
- Mixing Ratio: 100 parts 421-71XX, 3.5 parts 873-1205 catalyst
- Coverage: 472 sq. ft/gal at 1 mil dry. Varies depending on method of application or coating thickness.
- Reducer: 803-1325 or 803-1349
- Retarder: 800-5328

**275 VOC Post-Cat**

<u>5 Gallon</u>	<u>Finish</u>	<u>Sheen</u>	<u>List/ea</u>
421-7110-5	Matte	10	\$ 550.97
421-7120-5	Low Gloss	20	550.97
421-7140-5	Satin	40	573.17
<u>1 Gallon</u>			
421-7120-1	Low Gloss	20	166.00
421-7140-1	Satin	40	166.40

**COVAR 275 WHITE CONVERSION VARNISH TOP COAT**

A two-component coating that is a fast drying, good building product that shows excellent resistance to chemicals and physical wear. Has excellent leveling and a smooth, even appearance, even on open-grain woods. Sands easily and can be used as a self seal finish.

Ready to spray. Very low HAPs and very low VOC. Designed for use as a final coat on all types of solid wood and veneer meant for interior use.

Meets KCMA Standards, AWI 8th Ed.

- Weight solids: 46%
- Shelf Life: 6 months
- Mixing Ratio: 100 parts 117-71XX, 3.5 parts 873-1205 catalyst
- Coverage: 548 sq. ft/gal at 1 mil dry. Varies depending on method of application or coating thickness.

**275 VOC Pre-Cat**

<u>5 Gallon</u>	<u>Finish</u>	<u>Sheen</u>	<u>List/ea</u>
117-7110-5	Matte	10	\$ 646.00
117-7120-5	Low Gloss	20	645.76
117-7140-5	Satin	40	645.54
117-7160-5	Semi Gloss	60	500.00
<u>1 Gallon</u>			
117-7110-1	Matte	10	166.82
117-7120-1	Low Gloss	20	165.98
117-7140-1	Satin	40	166.79



**PLASTICOLOR WHITE TOP COAT**

**Plasticolor 275** white is a two-component, high solids topcoat. Gives a smooth, tough and hardwearing surface resistance influence from alcohol, water, etc. Very good light stability based on the type of resin used.



Meets ANSI/KCMA A161.1. Recommended AWI 8th Ed.

**Plasticolor 550** White is an acid curing, light stable, high solids, fast drying coating with good building properties. Gives a smooth, knock-proof and hardwearing surface resisting influence from alcohol, water, etc.

Meets ANSI/KCMA A161.1. Recommended AWI O.P.4.

- Weight solids: 275: 54% 550: 65%
- Shelf Life: 12 months
- Pot Life: 8 hours
- Mixing Ratio: 275: 100 part 117-19XX, 5 part 873-1900  
550: 100 part 117-10XX, 10 part 873-0870
- Coverage: 275: N/A  
550: 866 sq. ft/gal at 1 mil dry. Varies depending on method of application or coating thickness.

**275 VOC Post-Cat**

5 Gallon	Finish	Sheen	List/ea
117-1920-5	Low Gloss	20	\$ 736.60

1 Gallon	Finish	Sheen	List/ea
117-1920-1	Low Gloss	20	162.56

Reducer: 800-5500-5  
 Retarder: 800-5328

**550 VOC Post-Cat**

5 Gallon	Finish	Sheen	List/ea
117-1020-5	Low Gloss	20	\$ 663.70
117-1035-5	Satin	35	663.63
117-1050-5	Semi Gloss	50	664.30

1 Gallon	Finish	Sheen	List/ea
117-1020-1	Low Gloss	20	166.55
117-1035-1	Satin	35	166.82

Reducer: 803-1325, Retarder: 800-5328

**PLASTIPRIMER HARDWOOD WHITE PRIMER**

A fast drying, two part acid curing primer for interior use that gives a smooth, dense finish suitable for top-coating to produce very high quality pieces. Provides an excellent base and is extremely easy to sand. Designed for hardwoods. With excellent filling abilities due to high solids.



- Weight solids: 60%
- Shelf Life: 12 months
- Pot Life: 12 hours
- Mixing Ratio: 10 parts 522-1420, 1 part 873-0870 catalyst
- Coverage: 684 sq. ft/gal at 1 mil dry. Varies depending on method of application or coating thickness.
- Reducer: 803-1325
- Retarder: 800-5328

**550 VOC Post-Cat**

Code	Description	Size	List/ea
522-1420-5	White primer	5 Gal	\$ 618.82
522-1420-1	White primer	1 Gal	166.82

17



**E-VAR CLEAR TOPCOAT**

A two-component coating that is a fast drying, good building product that shows excellent resistance to chemicals and physical wear. Has excellent leveling and a smooth, even appearance, even on open-grain woods. Sands easily and can be used as a self seal finish. Ready to spray.



Meets ANSI/KCMA A161.1. Recommended AWI 8th Ed.

Weight solids: 275: 41% 550: 48%  
 Shelf Life: 12 months  
 Pot Life: 8 hours

Mixing Ratio: 100 parts 421-8XXX, 3 parts  
 873-1205 catalyst

Coverage: 576 sq. ft/gal at 1 mil dry. Varies depending on method of application or coating thickness.

**275 VOC Post-Cat**

5 Gallon	Finish	Sheen	List/ea
421-8410-5	Matte	10	\$ 564.00
421-8420-5	Low Gloss	20	564.00
421-8440-5	Satin	40	563.94
421-8460-5	Semi Gloss	60	532.02

**1 Gallon**

421-8420-1	Low Gloss	20	166.03
421-8440-1	Satin	40	166.82
421-8460-1	Semi Gloss	60	165.42
421-8490-1	High Gloss	90	150.90

Reducer: 803-1325, Retarder: 800-5328

**550 VOC Post-Cat**

5 Gallon	Finish	Sheen	List/ea
421-8220-5	Low Gloss	20	\$ 474.10
421-8240-5	Satin	40	472.30
421-8260-5	Semi Gloss	60	473.88

**1 Gallon**

421-8220-1	Low Gloss	20	165.57
421-8240-1	Satin	40	135.95

Reducer: N/A, Retarder: 800-5328

**COLORANTS for COATINGS**

These colorants are designed for use in high-performance, solvent-borne industrial coatings and stains. Widely compatible and available in a broad spectrum of colors.



**One Gallon Size**

Code	Color	List/ea
827-1224-1	Titanium White	\$ 290.03

**One Quart Size**

827-1224-D.25QL	Titanium White	\$ 85.53
827-1226-D.25QL	Red Oxide Y/S	89.96
827-1232-D.25QL	Burnt Umber	68.65
827-1233-D.25QL	Yellow Iron Oxide	62.66
827-1236-D.25QL	Lamp Black	52.62
827-1237-D.25QL	Quinacridone Red	194.11
827-1239-D.25QL	Quinacridone Violet	187.94
827-1246-D.25QL	Phthalo Green B/S	113.70
827-1247-D.25QL	Phthalo Blue I/S	114.85
827-1248-D.25QL	Med. Yellow	124.71
827-1249-D.25QL	Red	242.64
827-1337-D.25QL	Organic Yellow G/S	184.00
827-1442-D.25QL	Lead Free Orange	131.51

**REDUCER**



**803-1360** Reducer is formulated with a special blend of solvents to enhance the performance of our acid curing Reactive Amino Coatings (RAC). It is recommended that this product be used in hot climates.

Designed as a reducer blend for acid catalyzed coatings. It is also effective in nitrocellulose coatings.

Code	Description	Size	List/ea
803-1360-1	Reducer	1 Gal	\$ 64.83



## Chemcraft Waterborne Products

Chemcraft goes green without sacrificing top performance by taking the best attributes of existing products and adapting them into waterborne systems. From fast-drying primers to chemically resistant clear topcoats.

### AQUALUX UNICLEAR WATERBORNE CLEAR TC

An extremely durable acrylic with superior mar resistance. A water white resin system with excellent chemical resistance that offers hardness, clarity, soft feel and excellent surface slip.

Designed for interior furniture, fittings, kitchen cabinet and other wood applications.



Meets KCMA Standards. Rec. AWI Water Acrylic 8th Ed.

Weight solids: 30 +/-1%  
 Shelf Life: 6 months

<u>5 Gallon</u>	<u>Finish</u>	<u>Sheen</u>	<u>List/ea</u>
423-4610-5	Matte	10	\$ 544.48
423-4620-5	Low Gloss	20	544.49
423-4635-5	Satin	35	544.48
423-4650-5	Semi-Gloss	50	544.49

<u>1 Gallon</u>	<u>Finish</u>	<u>Sheen</u>	<u>List/ea</u>
423-4620-1	Low Gloss	20	166.00
423-4635-1	Satin	35	166.05

### AQUASET WATERBORNE WHITE TOP COAT

A very durable white topcoat, formulated with a self-cross-linking polymer for maximum chemical resistance. Aquaset will give a smooth and hardwearing surface, resisting influence from alcohol, water, etc. Non-yellowing and has very good light stability based on the type of resin used.

<u>5 Gallon</u>	<u>Finish</u>	<u>Sheen</u>	<u>List/ea</u>
423-2720-5	Low Gloss	20	\$ 725.93
423-2735-5	Satin	35	723.30

<u>1 Gallon</u>	<u>Finish</u>	<u>Sheen</u>	<u>List/ea</u>
423-2720-1	Low Gloss	20	166.58
423-2735-1	Satin	35	166.82

### AQUAPRIME PRIMERS

#### **550-1600 Aquaprime Waterborne White Primer**



Ready to use. Provides very good hiding when used as a primer only on hardwoods and MDF. Offers excellent filling due to its high solids content. Easy to sand, and may be topcoated with any Chemcraft topcoats. Formulated especially for windows, door frames, joinery pieces and cabinets.

Weight solids: 66%  
 Shelf Life: 6 months

<u>Code</u>	<u>Description</u>	<u>Size</u>	<u>List/ea</u>
550-1600-1	WB White primer	1 Gal	\$ 161.81
550-1600-5	WB White primer	5 Gal	487.10

#### **550-1602 Aquaprime II Waterborne Neutral Primer**

Ready to use primer. Same qualities as above, when tinted.

Weight solids: 64%  
 Shelf Life: 6 months

<u>Code</u>	<u>Description</u>	<u>Size</u>	<u>List/ea</u>
550-1602-1	WB primer	1 Gal	\$ 167.58
550-1602-5	WB primer	5 Gal	406.12

#### **550-1611 Waterborne White Stainblock Primer - Acrylic Resin**

Weight solids: 65%  
 Shelf Life: 6 months

<u>Code</u>	<u>Description</u>	<u>Size</u>	<u>List/ea</u>
550-1611-5	WB White Stainblock primer	5 Gal	\$ 522.28



**STAIN / STAIN BASE**



**PROMATCH C-MIX 275 WIPING STAIN**

An all purpose wipe stain for furniture, millwork and cabinets. Offers a simple, low VOC one step stain color with good clarity and ease of workability. May be clear coated with any of the solvent based Chemlack 275, Opticlear 275 or Plastofix Light 275 products as well as their sealers.



Acid stable - will not change color when an acid cured Chemcraft product is used to seal and topcoat them.

Code	Color	Size	List/ea
825-3901-1	Natural	1 Gal	\$ 165.52
825-3901-5	Natural	5 Gal	420.95

**PROMATCH C-MIX 240 STAIN BASE**

An all purpose wipe stain base for furniture and cabinets formulated to low levels of VOC for application in regulated areas. Hand or spray application. Offers a simple, one step stain color base, good clarity and grain fill with ease of workability.



Code	Description	Size	List/ea
825-9300-1	Clear stain base	1 Gal	\$ 166.82
825-9300-5	Clear stain base	5 Gal	639.91

**LOW VOC SPRAY STAIN BASE**

A spray stain base that offers a simple, low VOC one step color with good clarity. Can be tinted, as well as using permatone dyes or concentrated liquid dyes for the development of rich and deep colors.



Code	Description	Size	List/ea
890-6720-5	Spray stain base	5 Gal	\$ 339.10

**PROMATCH AQUA WATERBORNE SPRAY STAIN BASE**

A clear stain base that can be tinted to any color using 896, 888, 877 colorants, and Promatch Aqua dye.



Code	Description	Size	List/ea
824-2912-1	WB Clear stain base	1 Gal	\$ 166.82
824-2912-5	WB Clear stain base	5 Gal	520.62

**PROMATCH DYE CONCENTRATES**

Can be used to tint various stains or stain bases as well as a first coat on wood to give bright, clear transparent effects. Consists of dyes dissolved in acetone for zero VOC and compliant applications. For interior applications. 1 Gallon pails.



Code	Color	List/ea
890-8239-1	Black	\$ 166.82
890-8240-1	Warm Brown	166.82
890-8242-1	Red	166.82
890-8243-1	Yellow	166.82

## CATALYST / SOLVENT



### CATALYSTS

**873-1205** is a catalyst for acid catalyzed lacquers.



<u>Code</u>	<u>Description</u>	<u>Size</u>	<u>List/ea</u>
873-1205-1	Catalyst	1 Gal	\$ 136.12

**873-0870** is designed as a fast catalyst for Reactive Amino Coatings (RAC).

<u>Code</u>	<u>Description</u>	<u>Size</u>	<u>List/ea</u>
873-0870-1	Catalyst	1 Gal	\$ 105.85
873-0870-5	Catalyst	5 Gal	506.06

**873-1900** is designed as a catalyst for Reactive Amino Coatings (RAC) using the 275 VOC chemistry

<u>Code</u>	<u>Description</u>	<u>Size</u>	<u>List/ea</u>
873-1900-1	Catalyst	1 Gal	\$ 89.79

### RETARDER



**800-5742** Butyl Cellosolve is a glycol ether with a very slow evaporation rate. Use as a retarder solvent for nitrocellulose containing coatings when severe blushing due to extreme humidity is experienced. Significantly slows drying time, so it is recommended to start with an addition of 1% and not exceed 3%.

<u>Code</u>	<u>Description</u>	<u>Size</u>	<u>List/ea</u>
800-5742-1	Retarder	1 Gal	\$ 66.39

### FLATTENING PASTE

A powder dispersion used for gloss adjustment.



<u>Code</u>	<u>Description</u>	<u>Size</u>	<u>List/ea</u>
870-1432-1	Flattening Paste	1 Gal	\$ 167.30

### ACETONE

**800-5500** is a Ketone solvent with very fast evaporation. Very effective to reduce viscosity of nitrocellulose based lacquers. Also used for cleaning of equipment.



<u>Code</u>	<u>Description</u>	<u>Size</u>	<u>List/ea</u>
800-5500-5	Acetone	5 Gal	\$ 257.75

### MAK SOLVENT

MAK (Methyl n-Amyl Ketone) has a high solvent activity, slow evaporation rate, low density, low surface tension, and high boiling point. These properties make MAK a very good solvent for cellulosic lacquers, acrylic lacquers, and high-solids coatings.



<u>Code</u>	<u>Description</u>	<u>Size</u>	<u>List/ea</u>
800-5531-1	MAK solvent	1 Gal	\$ 167.53
800-5531-5	MAK solvent	5 Gal	414.33

### SOLVENT GLAZE

<u>Code</u>	<u>Description</u>	<u>Size</u>	<u>List/ea</u>
825-4011-5	Solvent glaze	5 Gal	\$ 519.83

### LOW VOC GLAZE BASE

<u>Code</u>	<u>Description</u>	<u>Size</u>	<u>List/ea</u>
825-5300-1	Glaze base	1 Gal	\$ 166.82



## THINNERS / CLEANERS

### **PREMIUM LACQUER THINNER**

5 Gallons

Thinner, Med Dry CA  
Compliant. 5 Gals.



<u>Code</u>	<u>Size</u>	<u>List/ea</u>
THINNER-5	5 Gals	\$ 199.00

### **ACETONE**

5 Gallons

5 Gallon Acetone. Clear, color-  
less volatile liquid. 99.5% pure.  
Highly flammable. California  
compliant.



<u>Code</u>	<u>Size</u>	<u>List/ea</u>
ACETONE-5	5 Gals	\$ 199.00

### **MINERAL SPIRITS**

1 Gallon

Mineral spirits is a clean, clear  
product that's used for thinning  
oil-based paint. It can also be  
used for thinning or cleaning  
stains and varnishes, as well as  
for cleaning up oil stains or spills.



<u>Code</u>	<u>Size</u>	<u>List/ea</u>
MS-1	1 Gal	\$ 33.00

### **NAPHTHA**

1 Gallon

Good for cleaning oily and waxy  
surfaces, including crayon marks.  
Naphtha is a stronger solvent than  
mineral spirits but not so strong  
that it damages any finish other  
than wax as long as you don't soak  
the surface. Evaporates quickly.



<u>Code</u>	<u>Size</u>	<u>List/ea</u>
NAPHTHA-1	1 Gal	\$ 35.00



### 3M SANDPAPER

#### HOW TO ORDER 3M COATED ABRASIVES:

Precut abrasive sheets are stocked in standard 9" x 11" sheets with the weight of the paper backing specified as either "A" light, "C" medium, or "D" heavy. Coatings are "open" for resistance to dust build-up. Order By Sleeve!



#### 3M PRODUCTION PAPER SHEETS

For wood and metal sanding. Stands up to heavy sanding heat and pressure. Open-coated with tough, hard aluminum oxide mineral. Tan in Color.



The following are all **Open Coat.**

Code	Sheet Size	Grit & Weight	Sheets/ Sleeve	List/ Sleeve
911-60DP	9" x 11"	60D	50	\$ 85.81
911-80DP	"	80D	50	68.58
911-100CP	"	100C	100	133.74
911-120CP	"	120C	100	133.74
911-150CP	"	150C	100	133.74
911-180AP	"	180A	100	92.00

#### 3M GARNET PAPER SHEETS

Sands wood to a smooth finish with light pressure. Sharp natural garnet "crushes down," exposing fresh sharp grit during use. Orange in color.



The following are all **Open Coat.**

Code	Sheet Size	Grit & Weight	Sheets/ Sleeve	List/ Sleeve
911-50DG	9" x 11"	50D	50	\$ 110.91
911-60DG	"	60D	50	90.00
911-80DG	"	80D	50	77.00
911-120CG	"	120C	100	151.00
911-180AG	"	180A	100	95.00
911-220AG	"	220A	100	99.48

#### 3M "WET-OR-DRY TRI-M-ITE" PAPER SHEETS

Coated with silicon carbide mineral. Ideal for obtaining a satin smooth finish on lacquer, varnish enamel, and synthetic coating. For use on wood, metal, plastic, fiberglass and for auto refinishing. Black in Color.



The following are all **Closed Coat.**

Code	Sheet Size	Grit & Weight	Sheets/ Sleeve	List/ Sleeve
911-220AW	9" x 11"	220A	50	\$ 105.00
911-320AW	"	320A	50	105.00
911-400AW	"	400A	50	105.00
911-600AW	"	600A	50	105.00



### 3M

### SANDPAPER

#### "TRI-M-ITE FRE-CUT" PAPER SHEETS

A stearated open coat paper for sanding of knotty pine, mahogany, fibre glass, or any surface where filling or loading is a problem. Silicon carbide grit. Light gray in color.



Order Per Sleeve!

<u>Code</u>	<u>Sheet Size</u>	<u>Grit/Wt.</u>	<u>Sheets/Sleeve</u>	<u>List/Sleeve</u>
911-80AF	9" x 11"	80A	50	\$ 116.00
911-100AF	"	100A	100	158.00
911-100CF	"	100C	100	180.00
911-120CF	"	120C	100	180.00
911-150AF	9" x 11"	150A	100	158.64
911-150CF	"	150C	100	180.00
911-180AF	"	180A	100	158.00
911-220AF	"	220A	100	158.00
911-280AF	9" x 11"	280A	100	158.00
911-320AF	"	320A	100	158.00

#### 3M PRODUCTION FRE-CUT GOLD RN PAPER SHEETS

For final hand or machine sanding of most materials including wood, metal, sealer/primer, plastics, and fibre glass. Open Coat, Aluminum Oxide on sturdy A wt. paper.



<u>Code</u>	<u>Sheet Size</u>	<u>Grit/Wt.</u>	<u>Sheets/Sleeve</u>	<u>List/Sleeve</u>
911-80ARN	9" x 11"	80A	50	\$ 100.13
911-100ARN	"	100A	50	88.60
911-120ARN	"	120A	50	88.60
911-150ARN	"	150A	50	88.60
911-180ARN	"	180A	50	88.60
911-220ARN	"	220A	50	88.60
911-320ARN	"	320A	50	88.60

#### 3M PAPER SHEETS 405U

- Fast cutting silicon carbide delivers exceptional finishes
- Load-resistant coating and open coat construction minimize loading for better finish and longer abrasive life
- Silicon carbide is ideal for general purpose sanding on wood, metal, plastic, dry wall, fiberglass, glass and ceramic
- Light A-weight paper backing has excellent conformability



<u>Code</u>	<u>Sheet Size</u>	<u>Grit/Wt.</u>	<u>Sheets/Sleeve</u>	<u>List/Sleeve</u>
9X11-150AF	9" x 11"	150A	100	\$ 149.00
9X11-180AF	"	180A	100	149.00
9X11-220AF	"	220A	100	149.00
9X11-280AF	"	280A	100	149.00
9X11-320AF	"	320A	100	149.00
9X11-400AF	"	400A	100	149.00

#### NORTON 9 x 11 SHEETS

Series A275  
No-Fil Magnum "Champagne"  
Size: 9" x 11"  
and 4-1/2" x 11"



Fast cutting premium white Aluminum Oxide grit on a tear-resistant paper back. Stearated. Open coat. Heavy duty yet flexible. B weight sheets.

<u>Code</u>	<u>Sheets/Slv</u>	<u>List/slv</u>
N911-80B	50 ea.	\$ 84.08
N911-100B	100	158.73
N911-120B	100	158.73
N911-150B	100	158.73
N911-180B	100	158.73
N911-220B	100	158.73
N911-280B	100	158.73
N911-320B	100	158.73
N911-400B	100	158.73
N911-600B	100	158.73



## SANDING BELTS

### 3M RESIN BOND BELTS

Closed Coat.  
Sold in Full Cartons.



Extra long life sanding belts, with resin bonding for resistance to frictional heat. For use on any material, including metal. Dark Brown color.

Code	Size	Grit	Ctn	List/ea
21480-80	2-1/4" x 80"	80X	10	\$ 14.95

### GRAPHITE COATED CANVAS

Graphite has long proven the most effective dry lubricant available for use in back of sanding belts to reduce heat and friction, increase speed and provide longer abrasive belt wear. Recommended by most belt-sander manufacturers.



Available in 12' lengths only.

Code	Width x Length	List/ea
GC4-1	4" x 12'	\$ 39.22
GC6-1	6" x 12'	52.07
GC8-1	8" x 12'	73.83

### JISCO MADE-TO-ORDER BELTS Special Order



Aluminum oxide, zirconia or silicon carbide, paper or cloth, regular or anti-static abrasive belts. From 1/4" to 52" wide in any length. Made to order with a lead time of around 2 days.

### NORTON PORTABLE SANDING BELTS

#### Open Coat

Norton Alum Oxide Cloth Belts. Strong "plyweld" butt joint runs smoothly in either direction.



Long lasting. X-wt. cotton backing. Made in U.S.A. Open Coat. 10 each per box. Sold in full boxes.

Code	Size	Grit	List/ea
N321-60	3" x 21"	60X	\$ 5.00
N321-80	3" x 21"	80X	4.65
N321-100	3" x 21"	100X	5.34
N321-120	3" x 21"	120X	5.92
N324-40	3" x 24"	40X	\$ 4.87
N324-50	3" x 24"	50X	5.43
N324-60	3" x 24"	60X	5.43
N324-80	3" x 24"	80X	5.23
N324-100	3" x 24"	100X	4.87
N324-120	3" x 24"	120X	4.87
N424-40	4" x 24"	40X	\$ 6.98
N424-50	4" x 24"	50X	6.98
N424-60	4" x 24"	60X	7.37
N424-80	4" x 24"	80X	7.24
N424-100	4" x 24"	100X	7.36
N424-120	4" x 24"	120X	7.36

### NORTON SANDING BELTS

#### Blue Belts



The premier edge-sanding belt for long life, rapid stock removal, and resistance to loading. Self-sharpening Zirconia Alumina abrasive is open-coated and resin-bonded on special Y-weight cloth backing for consistent finishes. Plyweld butt joint runs in either direction. Singleflex. Blue in color.

5 each per carton.

Code	Size	Grit	List/ea
N4132-80	4" x 132"	80	\$ 28.25
N6X89-80	6" x 89"	80	72.80

## SANDING BELTS

### VSM SANDING BELTS

Heavyweight  
Anti-Static



Aluminum Oxide Cloth Vitex Belts. Combination Closed/Open Coat to resist loading. Excellent for hardwood, plywood and particle board. Anti-Static Heavyweight Polyester Cloth is washable. Non-shrink and non-stretch. Grits 60-150 are black in color. Grits 40-50 are brown in color. Full Cartons only.

10 each per carton.

Code	Size	Grit	List/ea
V321-150	3" x 21"	150X	\$ 4.16
V321-120	" "	120X	4.16
V321-100	" "	100X	4.16
V321-80	" "	80X	4.46
V321-60	" "	60X	5.11
V321-50	" "	50X	5.95
V321-40	" "	40X	6.48
V324-150	3" x 24"	150X	\$ 5.33
V324-120	" "	120X	5.33
V324-100	" "	100X	5.33
V324-80	" "	80X	5.29
V324-60	" "	60X	6.55
V324-40	" "	40X	7.12
V424-150	4" x 24"	150X	\$ 7.30
V424-120	" "	120X	7.30
V424-100	" "	100X	7.30
V424-80	" "	80X	7.53
V424-60	" "	60X	7.67
V424-50	" "	50X	9.76
V424-40	" "	40X	10.04
V4132-120	4" x 132"	120X	\$ 30.28
V4132-100	" "	100X	30.28
V4132-80	" "	80X	31.78
V4132-60	" "	60X	32.42

## WIDE SANDING BELTS

### 3M 340D CLOTH WIDE BELTS

**3M**



- Premium alum oxide on a durable X-weight cotton cloth backing
- Open Coat grain for good cut on woods, with less loading
- Resin bond takes high heat & pressure for long life
- Washable backing for repeat use on high load woods

Pack: 60, 80 Grit - 3/box  
100, 120, 150, 180, 220 Grit - 5/box

Code	Size	60	80	100,120 150,180	220
3760-	37" x 60"	\$ 110	\$ 111	\$ 122	122
3775-	37" x 75"	-	151	159	-
4360-	43" x 60"	-	-	160	-
4375-	43" x 75"	163	168	160	160
5275-	52" x 75"	-	210	195	-

### VSM WIDE BELTS

Made in Germany



- Polyester cloth back is washable, non-shrink and non-stretch.
- Butt joint is reversible
- Open coated aluminum oxide
- Anti-static for dust control, spark control and longer belt life.
- Convenient 2-pack carton

2 each  
per carton.

Code	Size	Grit	List/ea
V3760-80	37" x 60"	80X	\$ 166
V3760-100	" "	100X	144
V3760-120	" "	120X	144
V3760-150	" "	150X	144
V3775-60	37" x 75"	60X	\$ 187
V3775-80	" "	80X	176
V3775-100	" "	100X	165

## SURFPREP WIDE BELTS



### WIDE BELTS, ALUMINUM OXIDE CLOTH

Surfprep - Special Order Only

- Unique Antistatic treatment
- Less heat, Less loading
- Semi-open coat
- 65% poly & 35% cotton blend
- Butt joint
- Level joint, no skipping
- Made in California



Cloth back belt with precision grain height and orientation in an open coat for a consistent finish. Ultra sharp grains require lower cutting force for less heat and compression. Tightest tolerance tape joint in the industry, and unique anti-static treatment.

Belt Size	Grit
37" x 60"	60
37" x 60"	80
37" x 60"	100-220
37" x 75"	60
37" x 75"	80
37" x 75"	100-220
43" x 75"	60
43" x 75"	80
43" x 75"	100-220
52" x 75"	60
52" x 75"	80
52" x 75"	100-220
52" x 103"	60
52" x 103"	80
52" x 103"	100-220

**CALL FOR QUOTE**

### WIDE BELTS, ALUMINUM OXIDE, PAPERBACK

Surfprep

- Unique Antistatic Treatment
- Less Heat, Less Loading
- Open Coat
- Paperback
- Superior Lap Joint
- Level joint, no bump
- Made in the USA

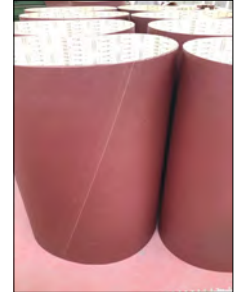

Paper back belt with precision grain height and orientation in an open coat for a consistent finish. Ultra sharp grains require lower cutting force for less heat and compression. Tightest tolerance tape joint in the industry, and unique anti-static treatment.

5 belts per carton.

Code	Size	Grit	List/ea
SP54103-80PA	54" x 103"	80PA	\$ 145.00
SP54103-100PA	" "	100PA	119.82
SP54103-120PA	" "	120PA	119.83
SP54103-150PA	" "	150PA	119.83
SP54103-180PA	" "	180PA	119.85
SP52103-80-PAOL	52" x 103"	80PA	\$ 126.98
SP52103-120-PAOL	" "	120PA	118.80
SP52103-150-PAOL	" "	150PA	118.80
SP52103-180-PAOL	" "	180PA	118.80

### WIDE BELTS, SILICONE CARBIDE, PAPERBACK

Surfprep



Code	Size	Grit	List/ea
SP54103-220PS	54" x 103"	220	\$ 127.92
SP52103-180-PSCL	52" x 103"	180	120.77
SP52103-220-PSCL	" "	220	120.77





## ABRASIVE ROLLS

### RESIN BOND ROLLS

Aluminum oxide material provides maximum cutting efficiency on most oscillating & block sanding operations. Resin bond construction assures mineral retention under extreme sanding pressure.

### 3M STIKIT ABRASIVE ROLLS

Self-Stick : PSA

For Finishing Sanders - A-wt.  
Light Gray in Color.



10 rolls per carton.

<u>Code</u>	<u>Size</u>	<u>Grit</u>	<u>List/rl</u>
41210-80AST	4-1/2" x 10 yds	80A	\$ 53.87
41210-100AST	" "	100A	53.84
41210-120AST	" "	120A	53.84
41210-150AST	" "	150A	53.84
41210-180AST	" "	180A	53.84
41210-220AST	" "	220A	53.84
41210-320AST	" "	320A	53.84

### VSM SANDING ROLLS

Aluminum Oxide paper "Vitex."  
Open coat. Anti-static E-weight  
paper backing. Red in Color.



6 rolls per carton.

<u>Code</u>	<u>Size</u>	<u>Grit</u>	<u>List/rl</u>
V41250-80	4-1/2" x 50 yds	80XE	\$ 197.95
V41250-100	" "	100XE	180.00
V41250-120	" "	120XE	180.00
V41250-150	" "	150XE	180.00

### 3M STIKIT TRI-M-ITE

#### REFILL ROLLS

Self-Stick : PSA

Light Gray in Color



<u>Code</u>	<u>Size</u>	<u>Grit</u>	<u>List/rl</u>
31445-80AST	3.25" x 55"	80A	\$ 8.51
31455-100AST	3.25" x 55"	100A	10.84
31470-120AST	3.25" x 70"	120A	8.81
31480-150AST	3.25" x 80"	150A	8.81
31485-180AST	3.25" x 85"	180A	8.81
31495-220AST	3.25" x 95"	220A	8.81

### 3M STIKIT SANDING BLOCKS

With Built-in Dispenser

Stickit sanding blocks fit the hand. Dispenses fresh abrasives easily. Unique design allows access to both curved areas and square edges.



45204

<u>Code</u>	<u>Description</u>	<u>List/ea</u>
45204-3M	Stickit Sand Block, 3-1/4" wide	\$ 43.18



## ABRASIVE PSA DISCS



### MIRKA SANDING DISCS PSA (Stick On), No Holes



Mirka "Bull Dog Gold" Finishing Discs offer a sharp, durable aluminum oxide abrasive grain. Its high-strength resin holds the grain in place for a longer-lasting disc, while the C-wt. backing is 50% stronger than A-wt. Gold in Color. No Holes. 100 discs per box. Sold in full boxes only.

<b>5" Dia.</b> Pack: 100 discs/bx	<u>List/ per box</u>
Code            80 <u>100,120,150,180, 220, 320</u>	
23-388-            \$ 69.54            \$ 56.21	

<b>6" Dia.</b> Pack: 100 discs/bx	<u>List/ per box</u>
Code            80 <u>100,120,150,180, 220</u>	
23-379-            \$ 93.68            \$ 88.00	

### MIRKA GOLD STICK-ON DISCS FOR VACUUM SYSTEMS

PSA (Stick On) discs for vacuum systems. Gold in Color.



80 = D-wt.  
100-220 = C-wt. 100 discs per box. Full boxes only.

<b>5" Dia, 5-hole Vacuum</b>	<u>List/ per box</u>
Code            80 <u>100,120,150,180, 220</u>	
23-321-            \$ 69.25            \$ 56.42	

### MIRKA 400 SERIES 5" PSA DISCS

5" PSA Discs. Gold in Color  
No holes, Plain White Box.



These Mirka supplied 5" C Wt. Aluminum Oxide discs have an aggressive cut rate. The heavy C Wt. Paper allows strong pressure especially at the edge of the disc. Lightly steared. No Holes. P-Graded grit. Gold in Color. Excellent value. Made in Finland.

<b>5" Dia.</b> Pack: 100 discs/bx	<u>List/ per box</u>
Code            80 <u>180, 220</u>	
5-420-            \$ 36.49            \$ 35.25	



### NORTON PSA DISCS

Series A275 No-fil Magnum. "Champagne" discs feature premium "White" Aluminum Oxide grit. Open Coat on flexible, tough B-weight paper, tear resistant for long life. No Holes.



<b>5" Dia.</b> Pack: 100 discs/roll	<u>List/ per roll</u>
Code            80 <u>100,120,150,180, 220, 320</u>	
N5-XXXB            \$ 101.90            \$ 90.61	

e.g. N5-100B

<b>6" Dia.</b> Pack: 100 discs/roll	<u>List/ per roll</u>
Code            80 <u>100,120,150,180, 220, 320</u>	
N6-XXXB            \$ 125.11            \$ 119.41	

e.g. N6-100B



### 3M ABRASIVE PSA DISCS

#### 3M HIGH PERFORMANCE CLOTH STIKIT DISC

900DZ (Purple) 5" discs. No Holes.  
Self-Stick : PSA

- Ceramic mineral, J-wt. cloth, open coat
- Premium, durable, long lasting Cubitron™ abrasive grain, flagship of the Stikit line
- Flexible, tear resistant cloth
- 3M Xodust products reduce static
- Individual discs with liner
- 5", No holes



Code	Description	Discs/bx	List/bx
5-100J	100 grit, " "	50 ea.	\$ 118.00
5-120J	120 grit, " "	50	118.00
5-150J	150 grit, " "	50	118.53
5-180J	180 grit, " "	50	118.53

#### 3M STIKIT DISC ROLLS

Self-Stick : PSA  
426U, No Holes

Silicone Carbide. No Hole, A-wt. paper for general purpose sanding of wood, glass, and fiber-glass. Treated for minimum loading. Light Gray in Color.



Code	Dia.	Grit	Discs/Roll	List/rl
5-80AST	5"	80A	125	\$ 92.61
5-100AST	5"	100A	125	98.28
5-120AST	5"	120A	125	98.28
5-150AST	5"	150A	175	121.24
5-180AST	5"	180A	175	121.24
5-220AST	5"	220A	175	121.24
5-320AST	5"	320A	175	121.24

#### 3M STIKIT GOLD FILM DISC ROLLS

5" discs. No Holes. Film Back.  
Self-Stick : PSA

An aluminum oxide Stikit gold disc roll constructed on a film backing. Features an anti-loading stearate coating. P graded. Open Coat. No holes. Works well with most wood species. The flexible film backing provides a consistent finish with greater tear-resistance than a comparable paper product.



Discs/Roll: 125, Rolls/Ctn: 4

Code	Diameter	Grit	List/rl
5-100ASTGF	5"	100A	\$ 148.33
5-120ASTGF	5"	120A	148.33
5-150ASTGF	5"	150A	148.33
5-180ASTGF	5"	180A	148.33
5-220ASTGF	5"	220A	148.33

#### 3M STIKIT GOLD DISC ROLLS

Self-Stick : PSA  
216U, No Holes

For final hand or machine sanding of most materials including wood, metal, sealer, primer, plastics, and fiber-glass. No holes. Gold Color.



Code	Dia	Grit	Disc/RI	Rls/Ctn	List/rl
5-80ASTG	5"	80A	125	10	\$ 123.14
5-120ASTG	5"	120A	125	10	120.51
5-150ASTG	5"	150A	175	6	168.00



## ABRASIVE DISCS



### FILM DISCS: VELCRO & PSA No-Hole 5" & 6"



**PSA 5" No-hole Film Abrasive Disc**



**VELCRO No-hole Film Abrasive Disc**

These no-hole discs have a strong and even film backing that allows for an even surface finish and longer life. Excellent for corner and edge sanding; more durable than paper discs, will not tear easily. Green in color. Available in PSA and Velcro.

#### Technical Specifications

Grain: Premium Aluminum Oxide  
Backing: Polyester Film  
Coating: Open Coat

#### After Sanding

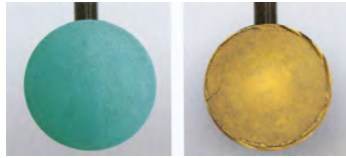

Film Product Paper Product

#### PSA 5" No Hole, Film Discs

Pack: 100 discs per box. List/ per box

<u>Code</u>	<u>80</u>	<u>100,120,150,180, 220, 320</u>
5FD-XXX	\$ 60.84	\$ 57.37

#### Velcro 5" No Hole, Film Discs

Pack: 50 discs per box. List/ per box

<u>Code</u>	<u>80</u>	<u>100,120,150,180, 220, 320</u>
5FD-XXX-V	\$ 48.60	\$ 43.26

e.g. 5FD-100-V

#### Velcro 6" No Hole, Film Discs

Pack: 50 discs per box. List/ per box

<u>Code</u>	<u>80</u>	<u>100,120,150,180, 220, 320</u>
6FD-XXX-V	\$ 58.30	\$ 57.30

e.g. 6FD-100-V



### HERMES VC152 5" PSA DISCS Peel and Stick

- 5" discs with peel-off back liner
- B/C Weight paper back
- Aluminum Oxide with anti-loading
- Pastel Tan color
- Made in USA



80 Grit: 50 discs/bx.  
120-220 Grit: 100 discs/bx.

List/ per box

<u>Code</u>	<u>80</u>	<u>120,150, 180, 220</u>
VC152V-XXX	\$ 29.65	54.25

### SIA 9-Hole HOOK & LOOP DISCS For Festool Sanders

- 5" or 6" 9-hole discs
- Aluminum oxide grit
- B-weight paper, Light Blue color
- Very high stock removal w/ good finish
- Ideal for manual use thanks to high flexibility
- Ideal for sanding large areas
- Can be used for a universal range of applications and materials

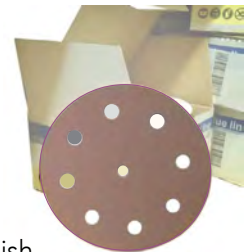

Pack: 100 discs per box.

<u>Code</u>	<u>Size</u>	<u>Grit</u>	<u>List/bx</u>
3547.7578.100	5"	100	\$ 94.42
3547.7578.120	5"	120	94.28
3547.7578.150	5"	150	94.42
3547.7578.180	5"	180	94.42
3547.7578.220	5"	220	95.92

<u>Code</u>	<u>Size</u>	<u>Grit</u>	<u>List/bx</u>
3365.8780.80	6"	80	\$ 132.00
3365.8780.100	6"	100	129.17
3365.8780.120	6"	120	129.17
3365.8780.150	6"	150	129.17
3365.8780.180	6"	180	129.17
3365.8780.220	6"	220	129.17

## HOOK & LOOP



### NORTON A275 5" HOOK & LOOP

5" 5-hole with hook & loop "Champagne" discs feature premium "White" Aluminum Oxide grit. Open coat on flexible, tough B-weight paper, tear resistant for long life. 5-holes. 100 discs per box.

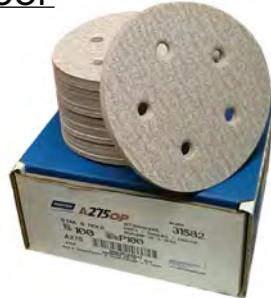

List/ per box

Code	80	100,120,150,180, 220, 320
N5-XXX-5H	\$ 142.00	\$ 132.71

### NORTON 5" HOOK & LOOP DISCS

With Hook & Loop Backing. A275 No-Fil Magnum "Champagne". Open Coat, B-wt paper. Premium "White" Aluminum Oxide grit. No Holes. 100 discs per box.



List/ per box

Code	80	100,120,150,180, 220, 320
N5-XXX-NH	\$ 137.00	\$ 135.17

## ABRASIVE DISCS



### HERMES VC151 - LONG LIFE 5" DISCS Hook & Loop

Available "No Hole" and "8 hole".

Hermes VC 151 Longlife VEL C Weight velour backed discs are designed for both metal and woodworking applications. This highly flexible tear resistant disc is used for intermediate and finish sanding on soft or hard woods, automotive primer, aluminum panels, parts and composite plastic and fiberglass mouldings. A stearate coating reduces premature loading and clogging. Sold per box.

- 5" Velour backed discs - C weight
- Resistance to loading and clogging
- Tough aluminum oxide grain assures long life and high stock removal rates
- Improved surface quality
- Conformability to contoured as well as flat surfaces
- Lasts longer and runs cooler due to open coat and velour backing.



VC151V8H  
8 Hole



VC151V  
No Holes

60, 80 Grit: 50 discs/bx.  
 120-320 Grit: 100 discs/bx.

### VC151V8H Hook & Loop, 8 Hole List/ per box

Code	60	80	100,120,150,180,220,320
VC151V8H-XXX	31.12	27.12	\$ 53.00

### VC151V Hook & Loop, No Holes List/ per box

Code	80	100,120,150,180,220,320
VC151V-XXX	\$ 28.00	\$ 54.25



## ABRASIVE DISCS

### SURFPREP ABRASIVES

Consistent finish, premium grit & long lasting

#### 5" Film Discs, Hook & Loop

Aluminum Oxide Film backed abrasive discs are used for leveling & finish sanding. Provides consistent finish, faster cut, tear resistant edges, and overall longer life. Sacrificial stearate allows for minimal loading.



Pack: 100 discs/box		List/ per box
Code	120	150, 180, 220, 320
SP5HLFXXX	\$ 76.00	\$ 72.42

#### 5" PaperBack Discs, Hook & Loop

5" Paper Backed, Aluminum Oxide discs. Fiber reinforced back for better edge-wear. Premium grit in an open coat for wood. Uniform scratch for even staining, less blotching.



Pack: 100 discs/box		List/ per box
<b>Hook &amp; Loop</b>	D wt: 80-150, C wt: 180-320	List/ per box
Code	80	100,120,150,180,220,320
SP5HLLPBXXX	\$ 45.13	\$ 42.39

<b>PSA</b>	D wt: 80-150, C wt: 180-320	List/ per box
Code	80	100,120,150,180,220,320
SP5PSALPBXXX	\$ 45.00	\$ 42.39

#### 5" Film Discs, PSA

Aluminum Oxide Film backed abrasives are used for leveling & finish sanding. Provides consistent finish, faster cut, tear resistant edges, and overall longer life. Sacrificial stearate allows for minimal loading. PSA.



Pack: 100 discs/box		List/ per box
Code	80, 100, 120	150, 180, 220, 320
SP5PSAFXXX	\$ 72.14	\$ 64.89

### High Performance Foam Abrasives, Hook & Loop

Red Aluminum Oxide Foam Hook & Loop Pads for even cutting and flat sanding. A must use inside drawer boxes where manual hand sanding is a challenge or where discs sanders do not allow for full coverage into a corner. Can be used to sand detailed white wood beading on moldings. This pad will not load or pill.



#### 3" x 4" Foam Pads

Sold per each, 25/ea per box.

Code	Grit	Holes	Thickness	List/ea
SPRF5R080	M+	No Hole	5mm thin	\$ 1.89
SPRF5R100	F	No Hole	5mm thin	1.89
SPRF5R150	VF	No Hole	5mm thin	1.89
SPRF5R180	SF	No Hole	5mm thin	1.89
SPRF5R220	SF+	No Hole	5mm thin	1.89
SPRF10R060	M	No Hole	10mm firm	\$ 2.25
SPRF10R100	F	No Hole	10mm firm	2.25
SPRF10R150	VF	No Hole	10mm firm	2.25
SPRF10R100.4	F	4 Hole	10mm firm	2.25
SPRFHR100	F	No Hole	1/2" squishy	\$ 1.75
SPRFHR150	VF	No Hole	1/2" squishy	1.75
SPRFHR180	SF	No Hole	1/2" squishy	1.75
SPRFHR220	SF+	No Hole	1/2" squishy	1.75

#### 3" x 7" Foam Pads

5mm pads: 25/ea per box.  
 1/2" pads: 10/ea per box.



Code	Grit	Holes	Thickness	List/ea
SPRF75R100	F	No Hole	5mm thin	\$ 3.91
SPRF75R150	VF	No Hole	5mm thin	3.91
SPRF7HR060	M	No Hole	1/2" squishy	3.91
SPRF7HR150	VF	No Hole	1/2" squishy	3.91
SPRF7HR220	SF+	No Hole	1/2" squishy	3.91

Description	Grit	Finish/Scratch
M	Medium	120 - 150
M+	Medium +	150 - 180
F	Fine	220 - 240
VF	Very Fine	280 - 380
SF	Super Fine	450 - 600
SF+	Super Fine +	600 - 700

## ABRASIVE DISCS

### SURFPREP, Hook & Loop Cont.

#### **5", 5-Hole Foam Discs**

Sold per each, 25/ea per box.



Code	Grit	Holes	Thickness	List/ea
SPDF55R150.5	VF	5 Hole	5mm thin	\$ 4.13

#### **5", 8-Hole Red Aluminum Oxide Paperback**

50/ea per box, Sold per box.



Code	List/ per box
SP5RHLPPXXX.8	100,120,150,180,220 \$ 35

### **SURFPREP FILM SHEETS**

Hook & Loop, Film backed.



100 sheets/box, sold per box.

Code	Size	Grit	Holes	List/bx
SP3X4HLF320	3" x 4"	320	No hole	\$ 69.30
SP3X7HLF180	3" x 7"	180	No hole	96.00

### **3M MICROFINISHING DISCS**

Micron Stikit Discs  
 Film Back



3M™ Imperial Microfinishing Film is fast-cutting and provides a precise, consistent finish. Strong polyester film is coated with premium, micron-graded mineral. Particles are electrostatically oriented for greater cutting efficiency, and resin-bonded for durability. Aluminum oxide. Adhesive backed. Widely used on solid surface products such as Corian™.

Pack: 25 discs per pack. Sold in full packs.

Code	Diameter	Microns	List/bg
5-100MIC	5"	100	\$ 61.42
5-60MIC	5"	25	61.34
5-30MIC	5"	25	61.34

### **MIRKA 5" PSA CLOTH DISCS**

The Mirka Hiolit discs are for sanding operations requiring both flexibility and the tear resistance of cloth.



Offers fast cut and long life where paper discs tend to tear. For use on metals, wood and most unfinished surfaces. Stands up to hard maple! Aluminum Oxide, cloth back/resin bond. Maroon in Color. 5" Discs. Full boxes only.

Pack: 50 discs/box

Code	60	80	120
5B-332-XXX	\$ 46.08	\$ 58.00	\$ 48.07

### **MIRKA ABRALON 6" HOOK & LOOP DISCS**

For Solid Surface



- Combines the benefits of abrasive cloth and non-woven products
- Foam center gives even pressure on contoured surfaces, corners and sharp edges



Fabric Face



Foam center,  
 Hook & Loop  
 Backing

Constructed with a fabric face, foam center and a hook & loop backing. Abrasive grains are bonded evenly to the fabric face. Openings in the fabric allow water, solvent and air to flow freely around the abrasive. Works especially well when sanding contoured surfaces, corners and sharp edges. Open-cell design holds large amounts of water or solvent for lubrication and cooling. Foam center also provides for even surface pressure that helps eliminate "finger marks" when hand sanding. No holes.

Pack: 20 discs per box. Sold per box.

Code	Diameter	Grit	List/bx
8A-241-180	6"	180	\$ 155.53
8A-241-360	6"	360	155.53
8A-241-500	6"	500	155.53
8A-241-1000	6"	1000	155.53
8A-241-2000	6"	2000	155.53
8A-241-3000	6"	3000	155.53
8A-241-4000	6"	4000	155.53



## SANDING DISCS

**MIRKA AUTONET** - Mesh Hook & Loop Sanding Discs  
(For solid surface and wood)

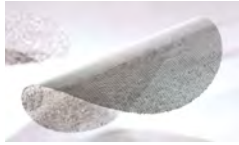

Autonet has a heavy mesh backing for high durability and better edge-wear. The coating of grain gives an aggressive rate of cut and the thicker loop backing diameter gives a better connection to the backup pad. Aluminum oxide grain with a polyamide mesh backing. For use with all vacuum and non-vacuum hook & loop disc pads.

**5" Dia.** Pack: 50 discs/box List/ per box

<u>Code</u>	<u>80</u>	<u>120, 150, 180, 240, 320</u>
AN-5-XXX	\$ 58.94	\$ 48.14

**6" Dia.** Pack: 50 discs/box List/ per box

<u>Code</u>	<u>80</u>	<u>120, 150, 180, 240, 320</u>
AN-6-XXX	\$ 68.00	\$ 58.75

## SUNMIGHT SOFT FLEX ROLLS

- Stocking 180, 220, 280, 320 and 400 Grits
- Designed for hand sanding applications
- Made with premium aluminum oxide grain, high quality latex paper, and strong phenol resin
- Flexible sponge backing
- Perforated to allow easy pad dispensing from box



<u>Code</u>	<u>Description</u>	<u>List/bx</u>
32110	4-1/2" W x 27 Yards / 180 Grit	\$ 105.86
32111	4-1/2" W x 27 Yards / 220 Grit	105.86
32113	4-1/2" W x 27 Yards / 280 Grit	105.86
32114	4-1/2" W x 27 Yards / 320 Grit	105.86
32116	4-1/2" W x 27 Yards / 400 Grit	105.86

## SANDING ACCESSORIES

### SURFPREP SANDING PAD

2-sided, Aluminum Oxide



150 grit. Size: 4-3/4" x 3-3/4" x 1/2".

2-sided soft hand pads. Eco-friendly brown A/O (Aluminum Oxide) soft hand pad features an innovative adhesive that allows it to stay sharper and last longer than any other pad in the market. Resists loading and outperforms any 'traditional' hand pads.

<u>Code</u>	<u>Description</u>	<u>Ctn</u>	<u>List/ea</u>
P150AO	2-sided sanding pad	250 ea.	\$ 1.82

### SANDING BLOCK

Aluminum Oxide abrasive coated over firm foam core. Fits easily into the palm of your hand.



Size: 2-3/4" x 3-3/4" x 1"

<u>Code</u>	<u>Grit</u>	<u>Ctn</u>	<u>List/ea</u>
BG150	150	250 ea.	\$ 2.25
BG180	180	250	2.25
BG220	220	250	2.25

### NORTON SANDING SPONGE

Norton high density sanding sponges can be used wet or dry. Only 3/16" thick for accurate and comfortable contour sanding. Coated on one side with a tough abrasive. Lasts 3x longer than sandpaper. Use for light material removal on wood, metal and other materials. Size: 4-1/2" x 5-1/2" x 3/16". Brown in color.



<u>Code</u>	<u>Description</u>	<u>Ctn</u>	<u>List/ea</u>
02255	Sanding sponge 220 x Fine	100	\$ 3.65
02256	Sanding sponge 150 x Fine	100	3.74





## SANDING ACCESSORIES

### MIRKA SANDING SPONGE

Professional Grade

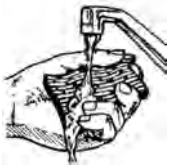

Rinse  
and Reuse!



Sanding sponge is made of Resin Bond cloth coated with a tough abrasive and laminated to a flexible 3/8" thick sponge. It can be used for all types of sanding jobs, (metal or wood surfaces), with maximum handling comfort from the three sponge sides. Works efficiently on contoured, flat, and hard-to-reach surfaces. Reusable - simply rinse clean and squeeze.

<u>Code</u>	<u>Description</u>	<u>Pack</u>	<u>List/pk</u>
1350-220	4" x 5" x 1/2", 220 grit	10 ea.	\$ 24.70

### 3M SANDING SPONGE

3-3/4" x 2-5/8" x 1" thick. Can be used on all types of sanding jobs. Reusable – simply rinse clean and squeeze. Abrasive material covers 4 sides of each sponge. Use wet or dry on wood, metal, and many other surfaces.



<u>Code</u>	<u>Description</u>	<u>List/ea</u>
908-3PK	3 Pack sponges, Fine on 2 sides, Medium on 2 sides	\$ 11.00
CP-001	Fine on all 4 sides, 150 grit	4.12

### 3M SANDING SPONGE

Bulk sanding sponge, 3-3/4" Length, 4-3/4" Width, 1/2" Thickness, Medium and fine grits available.

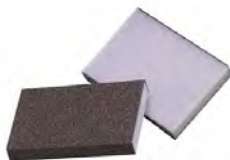

<u>Code</u>	<u>Description</u>	<u>Ctn</u>	<u>List/ea</u>
51065	Sanding sponge, Med grit	250	\$ 2.05
51066	Sanding sponge, Fine grit	250	2.83

### 3M "SCOTCH BRITE" ABRASIVE HAND PADS

Use like Steel-Wool



6" x 9"  
Pads

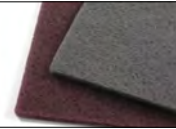

- 7447: Maroon, medium. For general purpose finishing of wood and cleaning of machinery. Approximately equal to #1 steel wool.
- 7448: Light gray, fine. For wood deburring and light finishing. Approximately equal to #00 steel wool.

<u>Code</u>	<u>Grade</u>	<u>Color</u>	<u>Ctn</u>	<u>List/pad</u>
7447	Medium	Maroon	60	\$ 3.09
7448	Fine	Lt. Gray	60	2.74

### 3M STIKIT DISC HAND PADS



Stickit Disc Hand Pads are made of neoprene rubber with a nylon face and an elastic band on back. For going into tight corners and curves with ease.

<u>Code</u>	<u>Description</u>	<u>Ctn</u>	<u>List/ea</u>
45189	5" x 1/4" Pad	20 ea.	\$ 19.14



## BACKING PADS

### 3M BACKUP PADS

Stickit vinyl disc face provides good disc adhesion and easy disc removal. Tough plastic hub and a comfortable foam body. No holes.

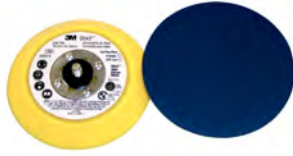

Use for paint repair, sanding between coats, sanding primer, white wood, and sealer sanding.

Hookit Low Profile Back-up Pad. Low profile soft density yellow pad provides flexibility to reduce loading. Tapered edge is ideal for finishing on flat or contoured surfaces. 5 holes.



Code	Description	Ctn	List/ea
05575	5" Stickit Disc Pad, No holes	10 ea.	\$ 38.52
05855	5" Hook & Loop Pad, 5-hole	10	50.66



Low Profile 6" Disc Pad. Precise multi-hole pattern provides superior dust extraction to prevent loading, increase productivity, and provide a cleaner work environment. Provides easy disc changes and optimizes disc life. 6", 52-hole, Hook & Loop.

Code	Description	Ctn	List/ea
20356	6" Hookit Disc Pad	10 ea.	\$ 69.00

### PORTER CABLE BACKING PADS



Code	Description	List/ea
13900	5" PSA, for 332PC	\$ 31.31
13901	5" PSA, 5-hole, for 334PC	37.18
13904	5" Hook & Loop, 5-hole	38.27

### SURFPREP BACKUP PADS

Consistent finish, durable & long lasting

Hook & Loop Backup Pads are made with smaller 'hooks' which are excellent for the 'quick release' of SurfPrep Foam abrasives. PSA are meant to be used with 'Pressure Sensitive Adhesive' (sticky) backed abrasives for flat sanding. Available for 3"x4", 3"x7", and 5" Sanders.



Code	Description	List/ea
SPBP5HL	Backup Pad, 5", Hook & Loop, No hole	\$ 35.44
SPBP5	Backup Pad	
SPBP5PSA	Backup Pad, 5", PSA, No hole	33.75



Code	Description	List/ea
SPBP3X4	Backup Pad, 3" x 4", Hook & Loop, No hole	\$ 31.50
SPBP3X7	Backup Pad, 3" x 7", Hook & Loop, No hole	42.00
SPBP	Backup Pad	

### MIRKA ABRANET VACUUM BACKUP PADS

Backup Pad Hook faced for use with Mirka Abranet® Abrasive Discs 5/16" x 24 Thread Size

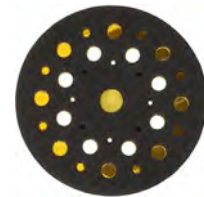

Code	Description	Ctn	List
916GV	6" Backup Pad	10 ea.	\$ 73.74 /ea
915GV28	5" Backup Pad	10	69.00
9955	5" Pad Saver	1	33.99 /bg
9956	6" Pad Saver	1	45.19

**TAPE**

**DISC BACKING PADS**

Velcro or PSA, 5" or 6", with or without holes.  
 Back-up pads are top quality molded polymer.



Mirka  
 6-hole, Velcro



Mirka  
 No hole, Velcro



Dynabrade  
 No hole, PSA

Code	Description	List/ea
M105	5" PSA, No Hole	\$ 45.17
56106	5" PSA, No Hole (Dynabrade)	36.40
M106	6" PSA, No Hole	40.23
M105V	5" PSA, 5 Hole	47.40
M106V	6" PSA, 6 Hole	36.09
M105GG	5" Velcro, No Hole	47.76
M105GV	5" Velcro, 5 Hole	47.61
M106GV	6" Velcro, 6 Hole	61.81

**See Festool Backing Pads pg 2061**

**BELT/DISC CLEANERS**



Sanding Belt and Disc Cleaner. Most belts and discs are discarded because they are clogged, not worn out. When held firmly (and carefully) against a running belt or disc, this rubberized substance removes the gummy clogging and restores the cutting ability. Abrasive life is extended many times, and downtime to change belt or disc is also reduced. Not to be used on wide belts or conveyor-type sanders. 2" x 2" x 8".

Code	Size	Ctn	List/ea
BC-228	2" x 2" x 8"	6	\$ 23.10

**SPEEDTAPE From Fastcap Contact Cement on a Roll**



An ultra bond transfer adhesive. Apply to a substrate then peel off paper backing and stick on laminate or veneer. Excellent for refacing, locating moldings, eliminating nail holes, and cabinet scribe. Apply edging without the glue clean-up from sprayed or rolled glue. Rolls are 50'. Other sizes can be special ordered.

Code	Size	List/rl
ST-34	3/4" x 50'	\$ 13.27
ST-1	1" x 50'	17.58
ST-2	2" x 50'	35.16



1" - Great for edgbanding



2" - Great for face frames

**DOUBLE-SIDED ADHESIVE TAPE**



Strong Temporary Bonds! Holds without clamps for quick jigs, router work and setting drawer fronts.

This strong paper tape is coated on both sides with an aggressive rubber-based adhesive. Makes instant, strong temporary bonds to a variety of surfaces. Convenient for hanging drawer fronts! Moisture-resistant and protected by a treated paper liner. Solves many odd clamping problems on the spot.

Code	Size	Ctn	List/rl
591	1"W x 36 yards	36 rolls	\$ 21.45

**CLAMP TAPE**



Heavy brown paper tape. Useful for light clamping, as well as boxing and packaging.

Clamps edge moldings & irregular assemblies

Code	Size	Ctn	List/rl
534-34	3/4"	48	\$ 5.63
534-1	1"	36	8.80
534-112	1-1/2"	24	13.12
534-2	2"	24	18.90

## ADHESIVE TAPES

### PG5 MASKING TAPE

A smooth crepe, premium painters' tape. PG5 offers an excellent balance of quick stick, holding properties and adhesive transfer resistance. Provides for easy application and clean, crisp paint lines. Allows excellent cornering and clean removal. Will support masking paper aprons at 160° F for 30 minutes. Not recommended for outdoor exposure.



Tensile strength rating: 25 lbs/in. of width. Thickness is 6.3 mils. Temperature resistant operating range of 50° F to 200° F. Adhesion to steel is 33 oz/in. of width. Bulk 60 yds/roll. Tan in color.

Government Specification Conformance  
 C.I.D. A-A-883B Type 1. Made in USA.

Code	Size	Ctn	List/rl
PG5-34	3/4"	48	\$ 7.29
PG5-1	1"	36	9.40
PG5-112	1-1/2"	24	17.07
PG5-2	2"	24	18.34

### 3M 2050 PAINTERS MASKING TAPE



The 2050 is a tan masking tape with a medium-high level of adhesion designed to release cleanly and easily from previously painted surfaces. Ideal for windows, doors, wall trim, cabinets, carpet and vinyl flooring. Conforms well to most surfaces, and produces good paint lines. Clean removal up to 3 days. (Not for automotive.) 60 yard rolls. Tan in color.

Code	Size	Ctn	List/rl
2050-34	3/4"	48	\$ 4.23
2050-1	1"	36	5.19
2050-112	1-1/2"	24	7.84
2050-2	2"	24	10.38

### 3M 2060 LACQUER GREEN MASKING TAPE

For Hard-to-Stick Surfaces



Designed for use with, or on, lacquer coatings. Does not lift, curl, or transfer adhesive with most lacquers. This tape can also be used on rough, uneven or hard to stick to surfaces. Conforms well to most surfaces, which produces an excellent paint line. Premium grade. High adhesion. 60 yds/roll.

Code	Size	Ctn	List/rl
2060-34	3/4"	48	\$ 4.87
2060-1	1"	36	7.16
2060-112	1-1/2"	24	10.21
2060-2	2"	24	14.13

Can Be Removed  
 Cleanly and Easily!

### 3M 2090 MULTI-SURFACE BLUE MASKING TAPE



Adhesive that allows the tape to be applied for up to seven days, then removed cleanly and easily from almost any type of surface. Even after prolonged exposure to sunlight, the 2090 tape can still be removed with virtually no adhesive transfer - even on glass. Use whenever there is concern about adhesive transfer or paint bleed-through. 60 yds/roll.

Code	Size	Ctn	List/rl
2090-34	3/4"	48	\$ 5.96
2090-1	1"	36	9.22
2090-112	1-1/2"	24	11.99
2090-2	2"	24	16.02

### HAND MASKER

Works with an array of masking papers, films, and tapes to fit any job's needs. The masker attaches tape to the edges of either film or paper, allowing a painter to easily mask off large areas.



Code	Description	List/ea
QM5000	Hand Masker	\$ 66.57
QM1012	12" Repl. Blade	25.00



## MASKING

### 3M YELLOW TAPE 60 Yard Rolls



- Solvent-free adhesive formula removes cleanly in one piece with no residue
- Withstands surface temperatures up to 225°F/107°C for 30 minutes
- Resists paint bleed-through to help create good paint lines
- Sticks with confidence on rubber moldings, plastic, glass, wood, concrete, metal and painted surfaces
- Smooth crepe paper is yellow in color and improves visibility and accuracy during paint masking
- Remains in place around corners, over contours and irregular surfaces

Tensile Strength: 22 lbs./in. width  
 Total Thickness: 6.3 mils (0.160mm)  
 Adhesion to Steel: 30 oz./in. width

Code	Size	Ctn	List/rl
301-34	3/4"	48	\$ 6.61
301-1	1"	36	9.79
301-1.5	1-1/2"	24	14.72
301-2.0	2"	24	19.83



### MASKING PAPER

12" x 180' Rolls

Great for masking off windows and door trim to prep for painting. Brown General Purpose Masking Paper is ideal for water based materials such as latex, plaster, drywall texture, etc. Ideal for residential and lighter applications, brown masking paper protects from paint overspray and splatters.

Green Premium Masking Paper is great for most water and oil based materials including lacquers and acrylics. This green masking paper protects from overspray and can be used for heavier applications.

Code	Description	Ctn	List/rl
12912	Brown (general purpose) Masking Paper	12	\$ 7.50
12212	Green (premium) Masking Paper	12	7.50

## TAPE

### CLEAR PACKING TAPE

2" x 110 yard rolls

Code	Ctn	List/roll
Q21108	36	\$ 4.72



### DUCT TAPE

Gray Cloth duct tape

2" x 60 yds, 24 rolls/ctn.

Code	List/roll
CD200-2	\$ 13.82



### FILAMENT TAPE

Bulk 60 yard rolls. Industrial grade fiberglass reinforced filament tape. 180 lbs. tensile strength in 3/4" size. Transparent back. Meets Federal Spec. PPP-T-97D Type 11.



Code	Size	Ctn	List/rl
RG15-12	1/2"	72	\$ 6.79
RG15-34	3/4"	48	10.33
RG15-1	1"	36	14.19

### 3M RESILIENT TREAD



3M™ Safety Walk™ Rolls and Strips are ideal for helping prevent slips and falls. Resilient Non-Slip Surfacing material is pressure sensitive and applies like tape. Resilient and durable, adheres to any dry, smooth surface. Color fast, completely washable. Can be painted.

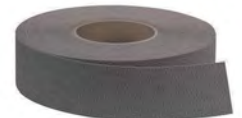

Code	Description	List/rl
7737	2" x 60', Black	\$ 95.20
7740	2" x 60', Gray	83.21

## SHRINK WRAP

### SHRINK WRAP FILM TAPE



Film tape is ideal for securing merchandise on a pallet, for transportation, or storage purposes. No residue. Secures and protects. Each full case includes one dispenser handle.

Code	Size	Ctn	List/rl
Q3120	3" W x 700' L	18	\$ 10.19
Q380	3" W x 1000' L	18	11.37
HF1781800-00	18" W x 1500' L	4	46.10

### SHRINK WRAP DISPENSER

For 3" Wide Shrink Wrap.



Code	List/ea
Q3HDL	\$ 7.68

### SHRINK WRAP FILM TAPE With Cardboard Handle

Now includes heavy duty built-in cardboard handle on each roll.



Pack: 18 rolls/carton

Code	Size	Gauge	List/Roll
Q3120D	3" W x 700' L	120	\$ 10.91
Q380D	3" W x 1000' L	80	10.04

## SAFETY GLASSES

### 3M SAFETY GLASSES

Anti-Scratch, Anti-Fog



- Economy-rated glasses are stylish and comfortable
- Wraparound design
- Integrated side-shields provide extra protection
- Contoured temples fit comfortably and snugly
- Polycarbonate lenses absorb 99.9% UVA and UVB

Code	Description	List/ea
11818	Contoured Frame, Anti-Scratch, Anti-Fog Lens	\$ 6.43

### FASTCAP SAFETY GLASSES

These quality safety glasses have a durable shatter-proof wraparound lens, reinforced temples and a comfortable rubber nose and bridge piece.



Code	Description	List/ea
SG-P510	Wraparound, Clear Lenses	\$ 12.17

### FASTCAP SAFETY READING GLASSES - 3 Diopters

- Comfortable, shatterproof, scratch resistant, wrap-around
- Anti-fog & anti-static coated lenses
- 35% lighter than standard glasses
- UV protection, ANSI / OSHA approved

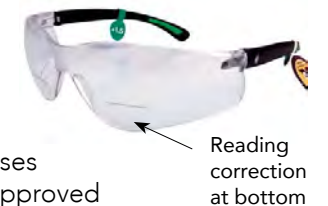

Code	Magnification	List/ea
SG-AF-MAG1.5	1.5 Diopter (least)	\$ 12.30
SG-AF-MAG2.0	2.0 Diopter (medium)	12.29
SG-AF-MAG2.5	2.5 Diopter (most)	12.29

### BLACK NECK BAND "Chums"

Soft, adjustable neck band to keep your glasses close by and ready to use. Black in color.



Code	List/ea
CHUMS-BLK	\$ 5.23

## EAR PROTECTION

### MOLDEX PURA-FIT DISPOSABLE EARPLUGS

6800



Pura-fit disposable earplugs are tapered so they are easier to insert in any size ear canal. Special foam formulated for softness and comfort. Outer surface is smooth; does not irritate worker's ears. Green in color. \*NRR: 31. 200 pairs per box. Full boxes only.

<u>Code</u>	<u>Bx</u>	<u>List/bx</u>
6800	200 pr	\$ 86.82

### MOLDEX SPARK PLUG DISPOSABLE EARPLUGS



Extra-soft, extra light foam seals ear canal without pressure. Tapered for a snug fit. \*NRR: 33. "Spark Plugs" are in bright neon colors. 200 pairs per box. Full boxes only.

<u>Code</u>	<u>Bx</u>	<u>List/bx</u>
6604	200 pr	\$ 73.44

### 3M DISPOSABLE EARPLUGS

1100-3M



Disposable earplugs are tapered so they are easier to insert in any size ear canal. The special foam is formulated for softness and comfort and the outer surface is smooth, so it does not irritate ears. These earplugs have shown a high rating under the new standard. \*NRR: 29. 200 pairs per box. Full boxes only.

<u>Code</u>	<u>Bx</u>	<u>List/bx</u>
1100-3M	200 pr	\$ 44.45

### 3M BANDED HEARING PROTECTOR

Lightweight and convenient, the 3M Banded Style Hearing Protector is comfortable for extended wear and helps reduce exposure to hazardous noise. Low profile; popular for use with a hard hat and additional safety gear.



The soft, flexible foam conforms to your ear canal, providing a personalized fit that helps protect your ears from potentially damaging sound.

- Pivots with the wearer to help provide consistent protection
- Attached band rests around your neck when not in use
- Ear tips are easily removable and replaceable
- Lightweight alternative to earmuffs
- Highly visible color for easy location on a busy jobsite
- Noise Reduction Rating (NRR) of 28 dB\*
- Helps protect against harmful noises that are at 85 dB and above



Replacement Tips are designed for use with the 3M Banded Hearing Protector #90537. 2 Pair per pack.

<u>Code</u>	<u>Description</u>	<u>List</u>
90537	Banded Hearing Protector	\$ 10.94 /ea
90538	Replacement Tips, 2 pr.	7.39 /pk

### 3M EARMUFFS

3M™ Peltor™ Optime™ 105 over-the-head earmuffs feature double-shell technology to provide effective hearing protection.



- Noise Reduction Rating (NRR) of 30 dB\*, highest available in over-the-head style earmuffs
- For noise exposures up to 105dBa
- Durable stainless steel headband resists bending and warping

<u>Code</u>	<u>Description</u>	<u>List/ea</u>
H10A	Ear Muffs	\$ 63.25



## FILTER MASKS

### MOLDEX DUST RESPIRATOR

2200

Smooth rubber straps don't irritate neck or hair. Molded nose bridge maintains seal without a metal band that can work open. Naturally contours to face. Longer lasting. NIOSH/MSHA approved. Protects against dust & mists.



20 Masks/Box  
Full Boxes only!

Code	Description	Ctn	List/ea
2200	Disposable Particulate Respirator	20 ea.	\$ 3.36

### MOLDEX DUST RESPIRATOR

2300 - With Exhale Valve

Exhale valve lets worker breathe out easily without hot air build-up. Smooth rubber straps don't irritate neck or hair. Molded nose bridge maintains seal without band that can work open. Naturally contours to face. Longer-lasting NIOSH/MSHA approved. Protects against dust & mists.



10 Masks/Box. Full Boxes only!

Code	Description	Ctn	List/ea
2300MO	Disposable Particulate Respirator w/ exhale valve	10 ea.	\$ 5.35

### MOLDEX DISPOSABLE/REUSABLE RESPIRATOR

For Paint Spray or Pesticides

Comes fully assembled. Includes cartridges, prefilters, and retainers.



Easy snap-off disposable cartridges make replacement fast and economical. A low maintenance reusable mask that is affordably disposable.

Code	Description	Ctn	List
M8112	Respirator	1 ea.	\$ 72.10
8010-	Replacement Pre-filters 10 pcs/bag, Full bags only	10 bgs.	91.10
8100	Replacement cartridges	30 pr.	30.17

1765

### 3M FILTER MASK

8210



NIOSH/MSHA approved. Dependable protection against dusts and mists with a PEL (permissible exposure level) not less than .05 mg/m<sup>3</sup>. Completely disposable, lightweight, and comfortable. Weighs only 1/4 oz. Soft self-supporting filter cup contours to facial features. Low profile for clear vision. Easy breathing and communication at normal tones.

Code	Description	Ctn	List/ea
8210	Dust Respirator	20 ea.	\$ 2.05

### 3M PARTICULATE MASK

8511

- NIOSH Approved: N95
- 3M "Cool Flow" valve
- Lightweight construction
- Stapled straps
- M-noseclip



The 3M 8511 mask is NIOSH approved: N95. At least 95% filtration efficiency against solid and liquid aerosols which do not contain oil.

Code	Description	Ctn	List/ea
8511	Particulate Respirator	10 ea.	\$ 3.88

### 3M PARTICULATE MASK

8200-3M



- N95 NIOSH Approved
- Dual Strap design for more secure fit
- Patented Filter Media with easy air flow.
- 3M recommended for light-duty applications.

Code	Description	Ctn	List/ea
8200-3M	Particulate Mask	20 ea.	\$ 1.05



## 3M RESPIRATORS

### 3M HALF FACEPIECE RESPIRATORS

6000 Series, Reusable

- Use with 3M bayonet style cartridges and filters
- Reusable
- Available in 3 sizes to fit most faces



Code	Size	Ctn	List/ea
6100	Small	24	\$ 22.23
6200	Medium	24	26.33
6300	Large	24	28.69

### 3M HALF FACEPIECE RESPIRATORS

7500 Series, Reusable

- Advanced silicone material provides a softer feel on the face
- Unique adjustment design helps reduce tension and pressure points on the face for unsurpassed comfort
- Adjusts easily so user has the option to wear the respirator in either traditional or drop-down mode
- Valve design helps make breathing easier
- Helps reduce heat and moisture buildup for cool, dry comfort
- Use with 3M bayonet style cartridges and filters



Code	Size	Ctn	List/ea
7502	Medium	10	\$ 65.97
7503	Large	10	72.57

### 3M RETAINER - 571

Used to hold 3M Particulate Filters 5N11 and 5P71/07194 (AAD) in place on top of 3M Respirators 5000 Series and 3M Cartridge 6000 Series.



Code	Description	Ctn	List/ea
571	Retainer for Mask	20 ea.	\$ 4.51

## 3M CARTRIDGES

### 3M ORGANIC VAPOR CARTRIDGE - 6001

NIOSH approved against over 80 organic vapors such as acetone, benzene, and carbon tetrachloride. Use with 3M Facepieces 6000 Series and 7000 Series with bayonet style cartridge holders. 2 ea per bag.



Code	Description	Ctn	List/bg
6001	Replacement Cartridge	30 bgs	\$ 26.06

### 3M ORGANIC VAPOR CARTRIDGE - 6005

NIOSH approved against formaldehyde and over 80 organic vapors such as acetone, benzene and carbon tetrachloride. Use with 3M Facepieces 6000 Series and 7000 Series with bayonet style cartridge holders. 2 ea per bag.



Code	Description	Ctn	List/bg
6005	Replacement Cartridge	30 bgs	\$ 32.59

### 3M PARTICULATE FILTER - 5P71



NIOSH approved for environments containing certain oil and non-oil based particles. Tested against particles approximately 0.3 micron in size.

Suggested uses: spray painting, lacquering, pesticide spraying. Use with 3M Respirators 5000 Series or 3M Cartridges 6000 Series, and 3M Filter Retainer 571.

Code	Description	Bx	List/bx
5P71	Pre-Filter 07194	10 ea.	\$ 40.32



## FILTER MASKS

### RZ™ M2 FILTER MASKS

RZ™ M2 Filter Masks are lightweight with a full mesh main body, for improved airflow and breathability.

Available in 3 different sizes plus different filter replacement packs (next column). Please make sure your filter replacements match the size of your mask! To get the right size mask for your face: Measure from the bridge of your nose to just below your chin.

**Med:** 3.5" - 4"

**Large:** 4" - 4.5"

**Xtra Large:** 4.5" and up



**Black**



**Titanium**



- Mesh Construction, Lightweight & Breathable
- 99.9% Effective - traps particulates down to .1 microns
- Replaceable Filters
- Dual one-way discharge valves - Reduce condensation
- Adjustable Velcro Strap - Universal fit
- 360 Degree seal - Prevents leakage
- Versatile - Durable - Washable

- Includes:**
- (1) RZ Mask
  - (2) F1 RZ Filters
  - (1) Storage bag

<b>Black</b>	<u>Size</u>	<u>List/ea</u>
M2-BL-M	Medium	\$ 61.58
M2-BL-L	Large	61.58
M2-BL-XL	Xtra Large	61.58

<b>Titanium</b>	<u>Size</u>	<u>List/ea</u>
M2-TI-M	Medium	\$ 61.58
M2-TI-L	Large	61.58
M2-TI-XL	Xtra Large	61.58

### RZ™ FILTER REPLACEMENT PACKS

3 Filters per Pack. Available in Medium, Large, and Extra Large to match your mask.



**F1** standard filter has two filter layers, the outer particulate filter and the internal active carbon element - effective towards fumes and odors.



**F2** High-Flo Filter has 40% better 'breathability' than the standard F1 filter. It has two layers of particulate filters. The F2 is for screening particulates, not fumes.



**F3** is the *premium* filter. It has the improved breathability of the High-Flo along with the active carbon filter. It is designed to filter particulates *AND* fumes.

<u>Code</u>	<u>Size</u>	<u>List/pk</u>
F1-	(M) Med, (L) Lg, or (XL) Xtra Lg	\$ 8.95
F2-	(M) Med, (L) Lg, or (XL) Xtra Lg	16.26
F3-	(M) Med, (L) Lg, or (XL) Xtra Lg	16.32

### 3M RESPIRATOR CLEANING WIPES



The 3M™ Respirator Cleaning Wipes clean and refresh elastomeric facepiece respirators, eliminating dirt and perspiration. Each disposable towelette is sealed in its own protective wrapper for maximum freshness and moistness. The towelettes easily clean away lint and light dirt and contain no alcohol or harsh chemicals. 100 per box.

- 8" x 10" (when unfolded) towelettes are individually packaged and sealed to ensure uncompromised sanitary quality
- Disposable, one-time-use for convenience
- Will not damage the facepiece materials
- Towelettes contain no alcohol or harsh chemical

<u>Code</u>	<u>Description</u>	<u>List/bx</u>
07065	Respirator Cleaning Wipes, 8" x 10", 100 per box	\$ 104.40



## SHOP TOOLS

### BOX OF FINISHING RAGS



Reclaimed clean, washed white T-shirt cotton knit. Low lint. Domestic.

S702-10: 10 lb. Box  
S702-50: 50 lb. Box

Sold in 10 and 50 lb. boxes. Rags range in size, most are approx. 12" x 24" to 21" x 24".

<u>Code</u>	<u>Description</u>	<u>List/bx</u>
S702-10	10 lb. box of reclaimed rags	\$ 49.95
S702-50	50 lb. box of reclaimed rags	215.00

### BENCH BRUSH



2618

This top quality duster brush has a 100% black horsehair fill. The beavertail-style lightweight hard wood block is 14". Bristle length is 8" and has a 2-1/2" trim depth.

<u>Code</u>	<u>Description</u>	<u>Ctn</u>	<u>List</u>
2618	Bench Duster Brush	12	\$ 21.96

### SHOE HANDLE WIRE BRUSHES



#300



#301B

Brass Wire Brush for furniture finishing.

<u>Code</u>	<u>Rows</u>	<u>Trim</u>	<u>L x W</u>	<u>Ctn</u>	<u>List/ea</u>
300	4 x 16	1-3/16"	11" x 1"	12	\$ 4.48
301B	3 x 7	1/2"	7-1/2" x 1/2"	36	1.64

## PACKING/MOVING SUPPLIES

### FURNITURE PADS

New Haven



Added protection for your cabinets during shipping! Blankets are offered in Standard Duty, Heavy Duty and Premium. All blankets 72" x 80".

#### 200-7280 Standard Duty Blanket

Made from heavy, non-woven synthetic material, strengthened by zig-zag quilting, double stitched binding and square corners for firmness and neatness. Blue in color.

#### CS-7280 Heavy Duty Blanket

For strong and long-lasting professional protection. Made from high-thread count woven, strong polyester and 1" zig-zag lock-stitched quilting. Double stitched binding on all 4 sides and secured with square corners. 38 oz. batting. Two-tone Dark Blue/Light Blue.

#### 55-7280 Premium Professional Blanket

Designed for the professional mover. Perfect for wrapping and moving high-end, valuable furnishings. Made with densely woven poly-cotton with a very high thread count. 1" zig-zag lock-stitched quilting, 38 oz. batting, double stitched binding on all 4 sides and secured with square corners. Two-tone Dark Blue/Light Blue.

<u>Code</u>	<u>Description</u>	<u>Fil</u>	<u>List/ea</u>
200-7280	Standard Duty	3.5 lbs.	\$ 15.83
CS-7280	Heavy Duty	7 lbs.	33.52
55-7280	Premium	7 lbs.	58.95

### WEBBING ROLLS

New Haven



Super strong 1" tubular webbing has many moving and storage uses. Helps protect load! Will outlast ordinary rope and costs less. 150' in length.

<u>Code</u>	<u>Description</u>	<u>Ctn</u>	<u>List/rl</u>
543-1	Nylon Webbing	1 roll	\$ 37.07



## GLOVES

### CLOTH GLOVES

These cloth gloves are made of a comfortable cotton polyester blend. Dotted with rubber on both sides. Natural color. Reversible.  
12 pr per carton. Full Cartons only.



Code	Size	Ctn	List/pr
3855S-P	Small	12 pr.	\$ 2.50
SKPVCDD-L	Large	12	2.64

### NON-SLIP WORK GLOVES

Blue textured latex coated palm and finger tips provide a secure non-slip grip. Great for material handling, shipping/delivery and general purpose.



Cotton/polyester blend fabric breathes while absorbing perspiration. Seamless knit construction allows great dexterity. Continuous knit wrist.

Material: 10 gauge, 40% polyester/cotton shell. 60% Latex (Rubber) coating.

Code	Size	Ctn	List/pr
3893-M	Medium Non-Slip gloves	12 pr.	\$ 3.34
3893-L	Large Non-Slip gloves	12	3.35

### MEDIUM DUTY GLOVES

Orange Latex Rubber



Comfortable rubber latex gloves with 13" cuff, pebble palm for safe grip. Resists paint & varnish remover, thinners, turpentine, mineral spirits, stains, shellacs, varnish & polyurethane.

Code	Size	Ctn	List/pr
2208-LG	Large Orange Latex gloves	12 pr.	\$ 6.76

### FASTCAP "SKINS" GLOVES



Fastcap Skin Gloves are the ultimate glove/hand relationship. Made of durable textured Nitrile rubber, these lightweight, seamless gloves have exceptional grip and are excellent for puncture and abrasion resistance.

Will work on most touchscreens. May not be as responsive with a screen protector. Cut, snag, and abrasion resistant. Machine washable and dries quickly. Great for light construction, glass handling and automotive repair.



Order size based on color-coded cuff:

- **Blue** = Small
- **Yellow** = Medium
- **Green** = Large
- **Red** = Xtra Large
- **Orange** = XX Large (special order)



Extreme dexterity and durability



Works with touchscreen devices!

Sold Full Pack Only, 12 pairs per pack.

Code	Description	List/pk
SKINS-12PK-SM	Skins, Small (Blue cuff)	\$ 91.98
SKINS-12PK-MED	Skins, Medium (Yellow cuff)	91.96
SKINS-12PK-LG	Skins, Large (Green cuff)	91.98
SKINS-12PK-XL	Skins, Xtra Large (Red cuff)	91.98



## GLOVES

### NITRILE EXAMINATION GLOVES

100% soft Nitrile. Broad range of chemical resistance. Strong puncture resistance. Lightly textured surface for wet or dry grip. Low-modulus design lets the glove conform gently to hand for wearing comfort. (4 to 6mm thickness). Blue in color. Medical grade.



Packed: 100 gloves per box.  
Sold in full boxes.



<u>Code</u>	<u>Size</u>	<u>Ctn</u>	<u>List/Box</u>
3116	Small	10 boxes	\$ 36.76
3117	Medium	10	36.67
3118	Large	10	36.40
3119	X-large	10	36.55

### NITRILE 7-MIL ORANGE GLOVES

Powder-Free, Latex-Free Nitrile 7-mil Industrial grade gloves. High visibility orange in color, puncture-resistant and chemical-resistant. Orange in color with Tetra Grip. 50 gloves/ box.



<u>Code</u>	<u>Size</u>	<u>Ctn</u>	<u>List/Box</u>
20424	Large	10 boxes	\$ 40.00
20425	X-large	10	40.00

### DISPOSABLE GLOVES

Latex powder-free industrial grade gloves. White in color. 100 ea/box. Sold in full boxes only.



<u>Code</u>	<u>Size</u>	<u>Ctn</u>	<u>List/Box</u>
10152	Small	10 boxes	\$ 26.79
10153	Medium	10	23.65
5818	Large	10	25.23

### VINYL STAINING GLOVES



Powder-free vinyl gloves resist most household chemicals. Excellent for painting, refinishing and general cleaning purposes. Unhanded. Soft vinyl comfort. No odor, white in color. Quality Std. ASTM D5250-92 medical grade. 100 ea/box. Sold in full boxes only.

<u>Code</u>	<u>Size</u>	<u>Ctn</u>	<u>List/Box</u>
3018	Large	10 boxes	\$ 18.35
3019	X-large	10	18.35

### 3M PROTECTIVE COVERALLS

A highly versatile protective coverall, which is mostly made from a unique microporous PE laminate, designed to be softer and drape better over the body. It is designed to offer a good barrier to particles and limited liquid splash but it also features a breathable SMMMS back panel.



One coverall per bag.  
Stocking Large and Extra Large sizes.

<u>Code</u>	<u>Description</u>	<u>List/bg</u>
4540-L	Coverall with Hood, Large	\$ 18.87
4540-XL	Coverall with Hood, X-Large	18.50



## PAINTING TOOLS

### 3M PAINT PREPARATION SYSTEM (PPS)

Adapters, Cups and Liners

#### Spray Gun Adapter

Allows for spraying in any direction.  
Maintains a consistent spray pattern



Code	Description	List/ea
16046	Type 15	\$ 31.74
16054	Type 18	71.46

#### Paint Cups and Collars

- Hard cups to support liners
- Contents can be mixed and/or shaken in cup
- Clear cup allows for amount remaining to always be visible



Code	Description	Box	List/bx
16115	Mini Cup, 6 oz (170 ml)	2 cups & 2 collars	\$ 60.00
16001	Standard Cup, 22 oz (650 ml)	2 cups & 2 collars	74.64
16023	Large Cup, 28 oz (850 ml)	1 cup & 1 collar	73.30

#### Disposable Liner and Lid



- Eliminates use of solvent for cleaning, in turn eliminates disposal of hazardous waste.
- 200 micron filter built into every lid which eliminates the need for strainers or filters
- Filter can be easily removed if spraying contact cements.

Code	Description	Box	List/bx
16114	Mini Liner/Lid, 6 oz (170 ml)	50 lids, 50 liners & 20 sealing plugs	\$ 218.15
16000	Standard Liner/Lid, 22 oz (650 ml)	50 lids, 50 liners & 20 sealing plugs	270.26
16024	Large Liner/Lid, 28 oz (850 ml)	25 lids, 25 liners & 10 sealing plugs	172.84

Sold in Full Boxes Only

1771

### 3M ACCUSPRAY ONE SPRAY GUN KIT

An all-in-one solution for mixing/measuring, filtering and spraying of primer, sealer, base and clear coat. Spray Gun features a lightweight, composite spray gun body that is molded in one piece, eliminating the complexity, wear and cleaning of small parts and pieces.



Uses a series of replaceable, transparent atomizing heads which can be reused 5-10 times and then simply removed and replaced.

Code	Description	List/kt
16580	Accuspray Spray Gun Kit	\$ 460.00
16609	2.0mm atomizing head (red)	44.00
16611	1.8mm atomizing head (clear)	45.76

#### PAINT STRAINERS

Strong, durable cone-shaped construction. 250/ pack.



Ideal for removing unwanted dust and other impurities from small quantities of paint. Made with synthetic mesh for more accurate pore sizes, better filtration of paint, and faster straining. Medium mesh strainers work on latex or oil based paints, and fine mesh strainers are especially suited for all lacquers and enamels.

Code	Description	List/pack
11105-250	Med. mesh paint strainer	\$ 80.00
11107-250	Fine mesh paint strainer	80.00

#### STAINING PAD

Ideal for applying stain to any surface without drips or blemishes. Uniquely composed of two layers: the terry cloth cover is soft and absorbent, while the inner sponge soaks up excess liquid to prevent drips and running.



Code	Description	List/ea
10101B	Staining Pad	\$ 2.75



## PAINTING TOOLS

### **DISPOSABLE PAINT BRUSHES**

These economy paint brushes have white Chinese bristles and a quality plain wood handle. Use to apply glue, varnish, or paint. So inexpensive you can simply throw brush away when done using. No need to waste valuable shop time cleaning brushes!



<u>Code</u>	<u>Width</u>	<u>Bristle Length</u>	<u>Ctn</u>	<u>List/ea</u>
1500-1	1"	1-1/2"	36	\$ .97
1500-112	1-1/2"	1-1/2"	36	1.20
1500-2	2"	1-1/2"	24	1.43
1500-212	2-1/2"	1-5/8"	12	1.66
1500-3	3"	1-5/8"	12	3.03
1500-4	4"	2"	12	4.97

### **DISPOSABLE FOAM BRUSHES**

Foam brushes have wooden handles. Paint flows on without brush marks. Use with oil base, enamel, latex and acrylic paints and varnish. Not recommended for shellac or lacquer. Disposable, for one-time use only.



<u>Code</u>	<u>Brush Width</u>	<u>Ctn</u>	<u>List/ea</u>
8500-1	1"	50 ea	\$ .79
8500-2	2"	50	1.23
8500-3	3"	40	1.52
8500-4	4"	30	1.90

### **ACID & GLUE BRUSH**

With a Tin Handle

6 ea/bag



<u>Code</u>	<u>Bristle Width</u>	<u>Bristle Length</u>	<u>Ctn</u>	<u>List/bg</u>
9002	1/2"	13/16"	36 bgs	\$ 2.70

### **ROLLER FRAME**

Heavy-duty 9" roller frame. 5-wire cage style, 5/16" diameter rod, plastic threaded grip with metal ferrule.



<u>Code</u>	<u>Description</u>	<u>Ctn</u>	<u>List/ea</u>
RF209-9	Roller Frame	12 ea	\$ 5.99

### **ROLLER COVER**



9" phenolic core roller, for use with glue, rubber cement, etc. Nap Length: 1/8".

<u>Code</u>	<u>Description</u>	<u>Ctn</u>	<u>List/ea</u>
RC118	Roller Cover	12 ea	\$ 5.64

### **TRIM ROLLER**

3" Throw-a-way economy roller with non-removable cover. Wire handle.



<u>Code</u>	<u>Description</u>	<u>Ctn</u>	<u>List/ea</u>
RT315	Trim Roller	12 ea	\$ 3.71



# Fastener Recognition/Tech Sheet

Nominal or Screw Diameter	Threads per inch	Major Diameter	Minor Diameter	Length Range	Min. Torque Lbs./inch
#5 0.125	14	.128/.122	.078/.072	3/8" - 1"	18
#6 0.138	13	.141/.135	.0787/.087	3/8" - 1-1/2"	18
#7 0.151	12	.154/.148	.0874/.096	1/2" - 2"	22
#8 0.164	11	.168/.161	.0937/.1028	1/2" - 3"	28
#9 0.177	10	.181/.174	.0984/.1098	1" - 4"	32
#10 0.190	9	.194/.187	.1098/.1189	5/8" - 6"	39

### Flat Heads



Size	Head Diameter		Driver Size
	Max	Min	
#4	.225	.195	1
#5	.252	.220	2R
#6	.255	.240	2R
#7	.295	.267	2
#8	.332	.292	2
#9	.335	.295	2
#10	.385	.340	2

### Pan Heads for Framing Screws



Size	Head Diameter		Driver Size
	Max	Min	
#7	Modified	Modified	2R

### Truss Heads



Size	Head Diameter		Driver Size
	Max	Min	
#6	.321	.303	2R

### Oval Heads



Size	Head Diameter		Driver Size
	Max	Min	
#5	.252	.220	2R
#6	.279	.244	2R

### Combo-Truss Heads for Machine Screws



Size	Head Diameter		Driver Size
	Max	Min	
#8	.384	.364	2,2R

### Pan Heads



Size	Head Diameter		Driver Size
	Max	Min	
#6	.270	.256	2R
#7	.296	.281	2
#8	.322	.306	2
#9	.373	.357	2

### Combo-Round Washer Heads



Size	Head Diameter		Driver Size
	Max	Min	
#8	.321	.303	2R
#9	.471	.376	2
#10	.500	.472	2

### Large Round Washer Heads

















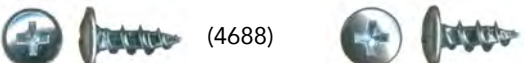

Size	Head Diameter		Driver Size
	Max	Min	
#8	.500	.472	2,2R





# SCREW & FASTENER INDEX

Page No.

BUGLE HEAD (Drywall) SCREWS		1811
CABINET CONNECTING SCREWS		1823, 1828
CONFIRMAT SCREWS/CAPS/DRILLS		1821
COVER CAPS		1823, 1831
DRAWBOLTS		1837
DRAWERFRONT SCREWS/ADJUSTERS		1822
DRAWERSLIDE SCREWS (Euro guide)	 (6-58FPDT)	1815
DRAWERSLIDE SCREWS (ball-bearing)	 (4688)  (4460)	1814
DRAWERSLIDE SCREWS (undermount)	 (7-58FPDT) use 6-58FPDT, 58-6 PHDT for clips	1815
EURO/SYSTEM SCREWS		1818
FACE FRAME SCREWS		1807
FASTAP SCREWS (Interior/Exterior)		1812, 1813
FLAT HEAD WOOD SCREWS (FHWS)		1816
FLAT HEAD TAPPING SCREWS (FHTS)		1817
GRASS WOOD SCREWS		1815
HARDWARE (Machine) SCREWS		1814



## SCREW & FASTENER INDEX cont.

Page No.

HEX HEAD SCREWS		1821
INSTALLATION SCREWS (WIC, dif. head finishes)		1810
KOLBE KORNER		1830
LAMELLO CABINET CONNECTORS		1825-1828
MELAMINE SCREWS		1813
PAN HEAD SCREWS		1816, 1817
PARTICLE BOARD SCREWS		1807
NIBBED HEAD SCREWS (self-countersinking)		1808, 1809
REAR SOCKET SCREWS		1815
SALICE EURO SCREWS		1818
SCREW DRIVER TIPS (Pozi, Phillips, Square)		1819
SQUARE DRIVE CABINET MAKER SCREWS		1807, 1809 1816, 1818
TITUS CONNECTORS		1823, 1825
TITUS SCREWS (Hi-Lo)		1823
TRIM HEAD STREAKERS		1811



## SENCO STAPLES

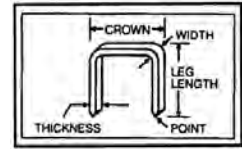

Note: Dimensions over each staple show leg length.

### FINE WIRE STAPLES - 3/16" Crown

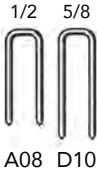

Crown: 3/16 (4.8)  
Width: .030  
Thickness: .0215  
Gauge: 22

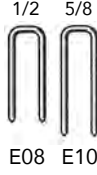

Crown: 3/16 (4.8)  
Width: .050  
Thickness: .019  
Gauge: 20

Use the E10 with  
KV 255 standards!

Code	Finish	Length	Box Qty	Boxes/Case	List/bx
A08BABP	Galv.	1/2"	30,000	8	\$ 120.96
D10BABPN	Galv.	5/8"	23,000	8	150.80
E08BAA	Galv.	1/2"	10,000	16	74.03
E10BAA	Galv.	5/8"	5,000	25	54.90

### MEDIUM WIRE STAPLES

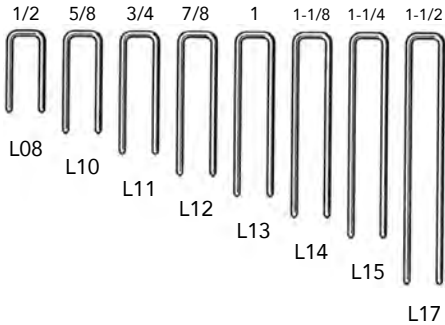

Crown: 1/4 (6.4)  
Width: .050  
Thickness: .044  
Gauge: 18

### MEDIUM WIRE STAPLES - 1/4" Crown

L08BAB	Galv.	1/2"	10,000	8	\$ 55.31
L10BABN	Galv.	5/8"	5,000	12	35.77
L11BRB	Metallic	3/4"	5,000	10	29.45
L12BAB	Galv.	7/8"	5,000	10	45.29
L13BRBN	Metallic	1"	5,000	8	\$ 41.44
L14BRB	Metallic	1-1/8"	5,000	6	53.05
L15BRB	Metallic	1-1/4"	5,000	6	52.42
L17BAB	Galv.	1-1/2"	6,000	6	60.08

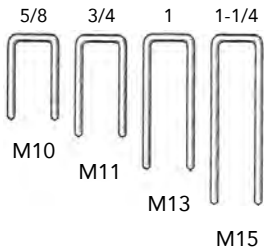

Crown: 3/8 (9.5)  
Width: .050  
Thickness: .044  
Gauge: 18

### MEDIUM WIRE STAPLES - 3/8" Crown

M08BAB	Galv.	1/2"	10,000	6	\$ 89.00
M10BRBN	Metallic	5/8"	5,000	9	51.42
M11BRBN	Metallic	3/4"	5,000	8	65.82
M13BRB	Metallic	1"	5,000	6	70.74
M15BAB	Galv.	1-1/4"	10,000	1	175.84

### HEAVY WIRE STAPLES - 7/16" Crown

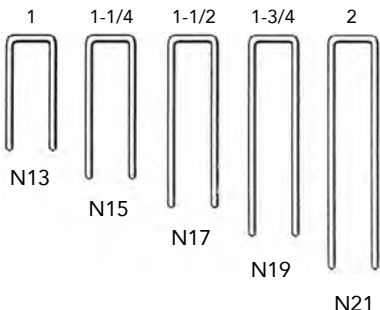

Crown: 7/16 (11.1)  
Width: .062  
Thickness: .055  
Gauge: 16

N13BAB	Galv.	1"	5,000	4	\$ 77.18
N15BRB	Metallic	1-1/4"	10,000	1	160.96
N17BRB	Metallic	1-1/2"	10,000	1	156.15
N19BRB	Metallic	1-3/4"	10,000	1	190.02
N21BRB	Metallic	2"	10,000	1	198.44



## STAPLES & BRAD NAILS

### MASTER FASTENERS MEDIUM WIRE STAPLES

Fits major brands of Staple guns.

**18 Gauge, 1/4" Crown, Galvanized.**

5000 per box.



Code	Length	Boxes/Cs	List/bx
MFL10BABN	5/8"	10	\$ 26.36
MFL11BRB	3/4"	10	22.14
MFL13BRBN	1"	10	31.17
MFL14BRB	1-1/8"	6	40.19
MFL15BRB	1-1/4"	6	33.42
MFL17BAB	1-1/2"	6	39.38

### MASTER FASTENERS FINISH AND BRAD NAILS

Fits major brands of Nail guns.

**15 Gauge Angled Finish Nails, Bright Metallic**

4000 per box.



Code	Length	Boxes/Cs	List/bx
MFDA13	1"	4	\$ 49.92
MFDA19	1-3/4"	4	57.89
MFDA21	2"	4	70.85

**18 Gauge Brad Nails, Galvanized**

5000 per box.



Code	Length	Boxes/Cs	List/bx
MFAX10	5/8"	20	\$ 28.98
MFAX11	3/4"	20	22.19
MFAX13	1"	20	32.95
MFAX15	1-1/4"	10	21.17
MFAX17	1-1/2"	10	25.28
MFAX21	2"	10	44.98

### SENCO FINISHING NAILS



**16 Gauge, Straight Strip Finish Nails**

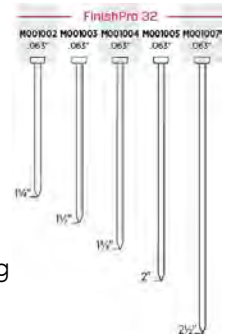

Best for furniture and cabinets, molding and trim, baseboard, chair rail, window casings and upholstery trim panels.

Galvanized finish, 2000 per box.

Code	Length	Boxes/Cs	List/bx
M001002	1-1/4"	6	\$ 19.73
M001003	1-1/2"	6	25.02
M001004	1-3/4"	6	26.87
M001005	2"	6	23.42
M001007	2-1/2"	6	25.76

### SENCO MEDIUM HEAD PINS

**21 gauge** pins offer significantly more holding power than 23 gauge pins while leaving a much smaller indent than an 18 gauge brad.

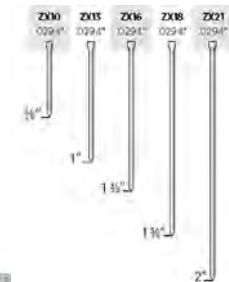

Straight Strip, Medium Head Pins 5/8" - 2".  
5000/bx.



Code	Length	Boxes/Cs	List/bx
ZX10EAA	5/8"	12	\$ 15.44
ZX13EAA	1"	12	22.50
ZX16EAA	1-3/8"	10	30.85
ZX18EAA	1-5/8"	10	33.91
ZX21EAA	2"	10	41.04

## SENCO BRADS & NAILS

### SENCO FINISHING NAILS & BRADS & PINS

#### 15 Ga. 34° Angled Strip Finish Nails

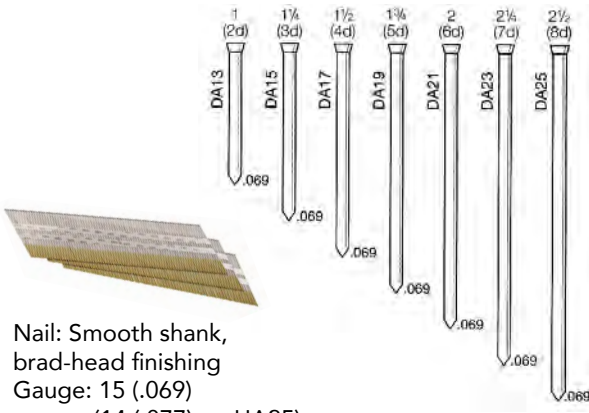

Nail: Smooth shank,  
 brad-head finishing  
 Gauge: 15 (.069)  
 (14 (.077) on UA25)

Code	Finish	Length	Qty	Boxes/ Case	List/bx
DA13EPB	Metallic	1"	4000	5	\$ 72.99
DA15EPB	Metallic	1-1/4"	4000	5	71.35
DA17EPB	Metallic	1-1/2"	4000	5	76.44
DA17EABN	Galv.	1-1/2"	4000	5	97.97
DA19EPB	Metallic	1-3/4"	4000	4	98.04
DA21EPB	Metallic	2"	4000	4	\$ 90.34
DA21EABN	Galv.	2"	4000	4	123.48
DA23EPB	Metallic	2-1/4"	4000	3	97.15
DA25EPB	Metallic	2-1/2"	4000	3	74.69
DA25EAB	Galv.	2-1/2"	3000	3	84.97

#### 18 Ga. Straight Strip Brad Nails



AX = Medium Head Brad  
 AY = Slight Head Brad

AY10	Galv.	5/8"	5000	16	\$ 63.11
AY11	Galv.	3/4"	5000	16	55.28
AY13	Galv.	1"	5000	10	53.16
AX13	Galv.	1"	5000	10	33.35
AX15	Galv.	1-1/4"	5000	10	33.84
AX17	Galv.	1-1/2"	5000	8	40.59
AX18	Galv.	1-5/8"	5000	8	40.29
AX19	Galv.	1-3/4"	5000	6	60.51
A202009	Galv.	2"	800	5	14.57
AX21EAAAN	Galv.	2"	5000	6	54.54

#### Straight Strip Micro Pins

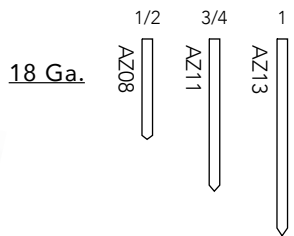

#### 18 Gauge Pins

AZ08EAAAN	Galv.	1/2"	5000	32	\$ 52.72
AZ11EAAAN	Galv.	3/4"	5000	24	59.93
AZ13EAAAN	Galv.	1"	5000	16	60.16

#### 23 Gauge Pins

A100509	Galv.	1/2"	2600	5	\$ 19.96
A100629	Galv.	5/8"	2600	5	21.59
A100759	Galv.	3/4"	2600	5	21.59
CZ11EAA	Galv.	3/4"	15500	4	26.79
A101009	Galv.	1"	2600	5	22.58
A101259	Galv.	1-1/4"	2600	5	29.96
A101379	Galv.	1-3/8"	2600	5	24.65
A101509	Galv.	1-1/2"	2600	5	28.53

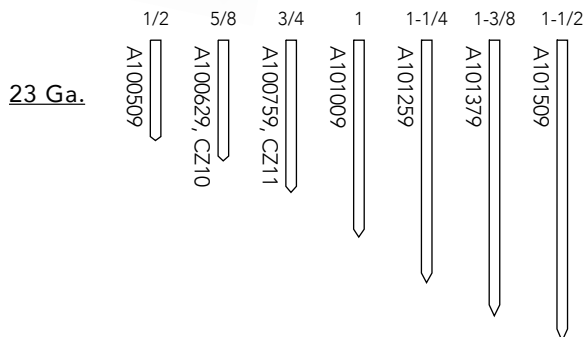



## GREX

## BRADS & FASTENERS

### GREX TOOLS

Headless Pinners and Pins

#### 23 Gauge Headless Pinner

Pinner

P635 3/8" - 1-3/8"

P650 3/8" - 2"



Code	Description	List/ea
P635	3/8" - 1-3/8" Pinner	\$ 372.40
P650L	3/8" - 2" Pinner	580.00

#### Headless Pins / Med Head Brads

P6 Series  
23 gauge  
Headless pins  
10,000/box

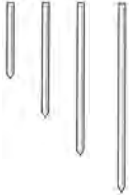

GBN Series  
18 gauge  
Brad Nails  
Medium  
Head  
5,000/box

23 Gauge	Description	List/bx
P6/10L	3/8" Headless Pins	\$ 19.87
P6/12L	1/2" Headless Pins	19.94
P6/15L	5/8" Headless Pins	19.13
P6/20L	3/4" Headless Pins	26.40
P6/22L	7/8" Headless Pins	27.45
P6/25L	1" Headless Pins	27.50
P6/28L	1-1/8" Headless Pins	21.81
P6/30L	1-3/16" Headless Pins	33.70
P6/35L	1-3/8" Headless Pins	35.70
P6/38L	1-1/2" Headless Pins	42.26
P6/40L	1-9/16" Headless Pins	36.52
P6/45L	1-3/4" Headless Pins	38.67
P6/50L	2" Headless Pins	53.19

#### 18 Gauge

GBN18-15	5/8" Brad Nails	\$ 28.62
GBN18-25	1" Brad Nails	30.85
GBN18-32	1-1/4" Brad Nails	31.42
GBN18-38	1-1/2" Brad Nails	32.90
GBN18-50	2" Brad Nails	34.67

### GREX TOOLS

Driver Kits

P6 Series 23 Gauge Headless Pinners are designed for longevity and optimal performance. Over time, drivers do fatigue and require replacement.



Code	Description	List/ea
P635-KB	For P635 tool. Includes: Driver Piston (63502), O-rings (96634, 96649, 96632), bumper (63309) and instructions	\$ 61.02
P650-KB	For P650 tool. Includes: Driver Piston (64503), O-rings (96649, 96603, 96604), bumper (64505) and instructions	69.36

### SENCORT™ CORRUGATED FASTENERS

Senco - For the SC2 Tool



X06NRA - 3/8"



X08NRA - 1/2"



Crown: 1", Thickness: .020", Gauge: 25  
Order by the box.

Code	Size	Box Qty	Boxes/ case	List/bx
X06NRA	3/8"	5,000	1	\$ 296.97
X08NRA	1/2"	4,000	1	291.22

### SENCLAMP FASTENERS

Senco - For the SC1XP  
Senclamp Tool



Crown: 7/16" (11.1)  
Thickness: .20  
Gauge: 25  
Bright Brass finish

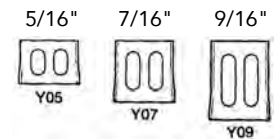

Code	Size	Box Qty	Boxes/ case	List/bx
Y05	5/16"	3000	8	\$ 184.43
Y07	7/16"	3000	8	219.59
Y09	9/16"	3000	6	236.00

## FACE FRAME SCREWS

### FACE FRAME SCREWS

Quickscrews

Pan Head with Type 17 Auger Point for quicker penetration. For hardwoods such as Oak or Maple.

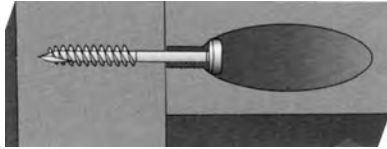

Square Dr	Size	Ctn	List/M
2722	6 x 1-1/4"	8000	\$ 30.82
2724	6 x 1-1/2"	7000	36.07

Phillips Hd	Size	Ctn	List/M
5715	6 x 1-1/4"	8000	\$ 32.15
5716	6 x 1-1/2"	7000	25.31

### "QUICK CUTTER" FACE FRAME SCREWS

Quickscrews

Square Pan Head Face Frame screws with a double auger point for fast cutting. For easy installation in extremely hard woods, such as hickory.



Code	Size	Ctn	List/M
4082	6 x 1-1/4"	8000	\$ 39.04
5215	6 x 1-1/2"	7000	39.26

### FACE FRAME SCREWS - For Particle Board

Quickscrews

A face frame screw with a coarse thread for faster driving and superior holding in softwoods, MDF, and particleboard. Type 17 Auger Point and #2 Square Dr.



Code	Size	Finish	Ctn	List/M
4080	7 x 1-1/4"	Zinc	8000	\$ 32.81
4080-XL	7 x 1-1/4"	Plain Steel	8000	27.02
4081	7 x 1-1/2"	Plain Steel	7000	34.74

### "HI-LOW" FACE FRAME SCREWS

Quickscrews

Plain Steel Finish. #2 Square Drive Head. Hi-Low Thread. Type 17 Auger Pt.



Code	Size	Ctn	List/M
4084	7 x 1-1/4"	8000	\$ 30.74
4085	7 x 1-1/2"	7000	35.39

### FACE FRAME SCREWS

Grabber

Pan Head Self-Tapping - for hardwoods. For cabinet assembly and installation. Has a special auger point designed to bore a pilot hole in the hardest wood. Drives faster, eliminates splitting. Black.



### PHILLIPS HEAD - Five Pound Boxes

Code	Size	Box	List/bx
V90-4	6 x 1-1/4"	1060	\$ 44.35
V90	6 x 1-1/2"	920	62.77

### PHILLIPS HEAD - Bulk Pack

Code	Size	Box	List/M
90S	6 x 1-1/4"	10000	\$ 43.13
90GR	6 x 1-1/2"	5000	70.52

### SQUARE DRIVE - Five Pound Boxes

Code	Size	Box	List/bx
V902Q4	6 x 1-1/4"	1105	\$ 58.70
V902Q	6 x 1-1/2"	950	63.43

### SQUARE DRIVE - Bulk Pack

Code	Size	Box	List/M
902Q4	6 x 1-1/4"	10000	\$ 61.81
902Q	6 x 1-1/2"	5000	69.62





# SCREWS

## CABINET ASSEMBLY SCREWS

### Quickscrews

Flat head with 4 nibs for self-countersinking. Zinc plated.



<u>Small Pack</u>	<u>Size</u>	<u>Ctn</u>	<u>List/M</u>
1177	1 x 8	1000	\$ 28.66
1178	1-1/4 x 8	1000	36.16
1179	1-1/2 x 8	1000	40.17
1180	1-5/8 x 8	1000	44.19
1181	2 x 8	1000	49.46
1183	2-1/2 x 9	500	78.26
1184	3 x 9	500	78.19

<u>Bulk Pack</u>	<u>Size</u>	<u>Ctn</u>	<u>List/M</u>
136	1 x 8	11000	\$ 26.70
137	1-1/4 x 8	9000	30.87
138	1-1/2 x 8	7000	33.40
139	1-5/8 x 8	6000	35.65
140	2 x 8	4000	44.19
142	2-1/2 x 9	2500	62.99
143	3 x 9	2000	70.75

## CABINET ASSEMBLY SCREWS

Type 17 Auger point for quicker penetration. Phillips Flat Head with 4 nibs for self-countersinking. Zinc plated.



<u>Small Pack</u>	<u>Size</u>	<u>Ctn</u>	<u>List/M</u>
9124	1 x 8	1000	\$ 33.28
13404	1-1/8 x 8	1000	40.70
9126	1-1/4 x 8	1000	37.60
9127	1-1/2 x 8	1000	41.73
9128	1-5/8 x 8	1000	48.27
9129	1-3/4 x 8	1000	45.47
9131	2 x 8	1000	46.21
9134	2-1/2 x 9	500	77.16
9135	3 x 9	500	82.30

## CABINET ASSEMBLY SCREWS cont.



<u>Bulk Pack</u>	<u>Size</u>	<u>Ctn</u>	<u>List/M</u>
9005SG	1 x 8	11000	\$ 26.81
13362	1-1/8 x 8	10000	31.06
9006SG	1-1/4 x 8	9000	30.41
9007	1-1/2 x 8	7000	36.25
9008	1-5/8 x 8	6000	37.38
9009	1-3/4 x 8	5000	40.81
9010	2 x 8	4000	49.51
9011	2-1/4 x 8	3000	55.48
9012	2-1/2 x 9	2500	62.89
9013	3 x 9	2000	77.12

## CABINET ASSEMBLY SCREWS

### Type 17 Combo Head

Type 17 Auger point for quicker penetration. Combo Square/Cross recess Flat Head with 4 nibs for self-countersinking. Coarse thread. Black finish available in some sizes.



<u>Small Pack</u>	<u>Size</u>	<u>Ctn</u>	<u>List/M</u>
2477	1 x 8	1000	\$ 29.76
2478	1-1/4 x 8	1000	34.22
2482	1-1/2 x 8	1000	39.33
2483	1-5/8 x 8	1000	44.33
2484	2 x 8	1000	53.36
2485	2-1/2 x 9	500	90.52
2486	3 x 9	500	101.44

<u>Bulk Pack</u>	<u>Zinc</u>	<u>Black</u>	<u>Size</u>	<u>Ctn</u>	<u>List/M</u>
1245	-	-	1 x 8	11000	\$ 25.94
1247	1249	-	1-1/4 x 8	9000	32.08
1250	1251	-	1-1/2 x 8	7000	36.73
1252	1253	-	1-5/8 x 8	6000	40.47
1254	1255	-	2 x 8	4000	48.41
1256	1257	-	2-1/2 x 9	2500	74.22
1258	1259	-	3 x 9	2000	88.78



**SCREWS**

**CABINET ASSEMBLY SCREWS**

Type 17 #2 Square Drive

Square Drive Flat Head Screws. Four nibs on-head for self counter-sinking and a type 17 auger point for quicker penetration. Zinc in color.

All sizes 1" length and shorter are fully threaded.



<b>Small Pack</b>	<u>Size</u>	<u>Ctn</u>	<u>List/M</u>
12657	1 x 8	1000	\$ 31.38
12658	1-1/4 x 8	1000	35.29
12659	1-1/2 x 8	1000	41.69
12660	1-5/8 x 8	1000	44.67
12661	1-3/4 x 8	1000	48.73
12662	2 x 8	1000	53.80
12664	2-1/2 x 9	500	77.79
12665	3 x 9	500	85.73

<b>Bulk Pack</b>	<u>Size</u>	<u>Ctn</u>	<u>List/M</u>
12613	1 x 8	11000	\$ 26.70
12614	1-1/4 x 8	9000	31.81
12615	1-1/2 x 8	7000	37.73
12616	1-5/8 x 8	6000	44.02
12617	1-3/4 x 8	5500	43.18
12618	2 x 8	4000	45.56
12620	2-1/2 x 9	2500	68.22
12621	3 x 9	2000	79.10

**CABINET ASSEMBLY SCREWS**

Quickscrews, Black finish

Square Drive, Flat Head, Coarse Thread, Black Screws.



Sq. Dr.

<u>Code</u>	<u>QS#</u>	<u>Size</u>	<u>Ctn</u>	<u>List/M</u>
34-8B-SQ	178	3/4" x 8	12000	\$ 22.30
1-8B-SQ	179	1" x 8	10000	25.79
114-8B-SQ	185	1-1/4" x 8	9000	28.55
112-8B-SQ	186	1-1/2" x 8	7000	49.09
134-8B-SQ	187	1-3/4" x 8	5000	38.53
2-8B-SQ	188	2" x 8	4000	42.40
212-8B-SQ	189	2-1/2" x 9	2500	64.66

**CABINET ASSEMBLY SCREWS  
 ROUND WASHER HEAD**

Round Washer Head, Combo Drive #2 Square/Phillips, Coarse Thread.

Designed for softer woods or particle board.



**Combo Square/Phillips Drive**

<u>Code</u>	<u>Size</u>	<u>Finish</u>	<u>Ctn</u>	<u>List/M</u>
6468	1-1/8 x 8	Zinc	9000	\$ 33.88
4321	1-1/4 x 8	Plain Steel	8000	25.20
1636	1-1/4 x 8	Zinc , White (head)	8000	73.94

**Type 17 #2 Square Drive**

13292	1-1/4 x 8	Zinc	9000	\$ 36.33
-------	-----------	------	------	----------



**CABINET ASSEMBLY SCREWS  
 QUICK CUTTER**

Type 17 Phillips Flat Head

For Hardwood Applications

Phillips flat Head with 4 nibs, Double Auger Shank, and Type 17 Auger Point. Minimizes pre-drilling in hardwood applications. Replaces Twinfast-type fasteners. Zinc in color.



<u>Code</u>	<u>Size</u>	<u>Ctn</u>	<u>List/M</u>
7317	1-1/4 x 8	9000	\$ 41.47
7318	1-1/2 x 8	7000	44.51
7319	1-5/8 x 8	6000	51.11
7320	1-3/4 x 8	5000	53.70
7322	2 x 8	4000	63.98
7323	2-1/4 x 8	3000	73.38
7324	2-1/2 x 8	2500	87.16
7325	3 x 8	2000	98.79
7326	3-1/2 x 10	1000	174.39
7327	4 x 10	1000	200.07



## SCREWS

### CABINET INSTALLATION SCREW

Works in both Wood or Metal Studs

These WI approved installation screws work in wood or metal studs. They have a #3 Phillips Round Washer Head, Hi-Lo thread and a double auger. Zinc in color.



WI Approved



Code	Size	Ctn	List/C
8214	2-1/2 x 14	1500	\$ 19.93
8215	3 x 14	1200	24.35
8216	3-1/2 x 14	1000	41.73
8217	4 x 14	700	46.05

Code	Description	Ctn	List/M
11980	3 x 14, White head	1200	\$ 365.09

### CABINET INSTALLATION SCREW

Round Washer Head

Combo Square Drive and Phillips Head. Zinc Plate or Painted Head: White, Sand or Black. Quick Cutter™ Double Auger.



White



Sand



Black

Zinc



Code	Size	Head	Ctn	List/M
7927	2-1/2 x 10	Zinc	1500	\$107.93
7935	3 x 10	Zinc	1500	112.30
7936	3-1/2 x 10	Zinc	1000	155.63
8010SG	2-1/2 x 10	Ptd. White	1500	123.21
8011	3 x 10	Ptd. White	1500	165.82
13794	3 x 10	Sand	1500	178.01
9912	3 x 10	Black	1500	140.61

### CABINET INSTALLATION SCREW

Drill point penetrates 12-16g Steel Gauge Metal studs. Self Drilling (or SDS Screws). Phillips drive, Zinc plated.

15178



11976



Code	Size	Head	Ctn	List/M
15178	3" x 8	Phil, Flat head	1250	\$ 114.65
11976	3" x 14	Phil, Round washer head	1000	300.17

### SELF-TAPPING SCREWS

Phillips, Truss Head

Type A SMS #14 X 3 Phillips Truss Head Self Tapping Screw with Type 17 Auger point. Zinc Plated. Used for Cabinet Install with Wood or light gauge metal studs. WI Approved. Drive Phil. #2.

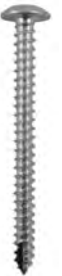

Code	Size	Head	Ctn	List/M
2052	3" x 14	Truss	100	\$ 221.46

### QUADREX WHITE POWDER COATED SCREWS

Epoxy coated, Quadrex head

White, epoxy-coated Quadrex head screws are deep thread with a pan/washer head. Head size is 3/8" diameter. Drives best with the 13113 Quickscrews screwdriver bit, though a #2 Square driver (11778) will work.

White



Code	Size	Box	List/bx
8114B	1-1/4" x 8	7000	\$ 392.04

Code	Description	List/ea
13113	Combo Head Bit	\$ 3.99





## SCREWS

### BUGLE HEAD COARSE SCREW

Grabber



Fastens sheetrock to wood, with superior holding power and ease of penetration. No. 2 Phillips recess. Black.

#### One Pound Boxes

(Approx. count)

<u>Code</u>	<u>Size</u>	<u>Box</u>	<u>List/bx</u>
X300	1-1/4 x 6	262	\$ 7.60
X400	1-5/8 x 6	202	7.60
X500	2 x 7	140	7.63
X1100	3 x 8	80	11.45

#### Five Pound Boxes

<u>Code</u>	<u>Size</u>	<u>Box</u>	<u>List/bx</u>
V100	1 x 6	1580	\$ 33.75
V300	1-1/4 x 6	1315	43.86
V400	1-5/8 x 6	1010	35.61
V500	2 x 7	702	48.10
V1100	3 x 8	400	43.44

#### Bulk Boxes

<u>Code</u>	<u>Size</u>	<u>Box</u>	<u>List/M</u>
100GR	1 x 6	10000	\$ 22.89
300GR	1-1/4 x 6	8000	29.61
400GR	1-5/8 x 6	5000	28.71
500GR	2 x 7	3500	57.26
900	2-1/2 x 8	2500	79.08
1100GR	3 x 8	2000	59.81

### PHILLIPS BUGLE HEAD DRYWALL SCREW

Quickscrews



Coarse thread, Zinc gold plated, sharp point.

<u>Code</u>	<u>Size</u>	<u>Finish</u>	<u>Ctn</u>	<u>List/M</u>
9703	3" x 8	Zinc, yellow	2000	\$ 55.75

### BUGLE HEAD FINE SCREW

Grabber



For sheetrock and metal studs. Attaches sheetrock to 20-25 gauge steel. Standard bugle head. No. 2 Phillips recess. Black.

#### Five Pound Boxes

(Approx. count)

<u>Code</u>	<u>Size</u>	<u>Box</u>	<u>List/bx</u>
V1368	4 x 10	235	\$ 99.15

#### Bulk Boxes

<u>Code</u>	<u>Size</u>	<u>Ctn</u>	<u>List/M</u>
368	1-1/4 x 6	8000	\$ 16.98
968	2-1/2 x 8	2500	\$ 75.46

### BUGLE HEAD CABINET SCREW

Grabber



For cabinet assembly and installation. No. 2 Phillips recess. Black.

<u>Code</u>	<u>Size</u>	<u>Ctn</u>	<u>List/M</u>
6W	1-1/2 x 7	5000	\$ 40.31

### TRIM HEAD STREAKERS

Grabber



Attaches wood trim over single or double layer gypsum board to 20-25 ga. steel. Square Drive. Black.

<u>Code</u>	<u>Size</u>	<u>Ctn</u>	<u>List/M</u>
17S	1-5/8 x 7	10000	\$ 33.65
18S	2-1/4 x 7	5000	51.84
17S76	3 x 8	2000	111.11

Self-Drilling Streaker:

17SD76	3 x 8	2000	\$ 160.22
--------	-------	------	-----------

## FASTAP SCREWS

### FASTAP SELF-DRILLING CARPENTRY SCREWS

Tougher Than  
 Drywall Screws!

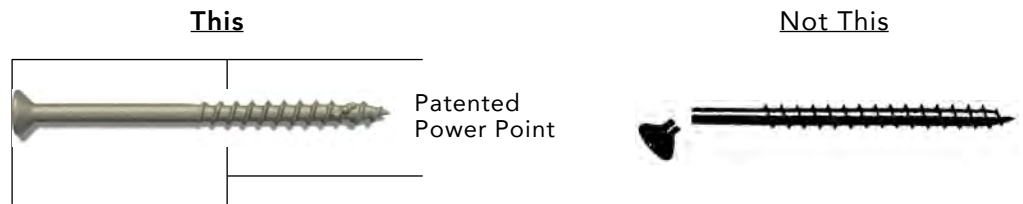

**Self-Drilling:** Revolutionary Power Point creates a pilot hole as you drive the screw. No pre-drilling needed even in the hardest wood.

**45° Threads:** Coarse threads with unique 45° angle holds tight for superior pull-out resistance in all woods. Hardened and tempered for greater strength. No need to worry about screws breaking on the job!

**Self-Countersinks:** Flat head with nibs head design helps resist over-driving and gives you a flush fitting countersink that locks screws tight. Phillips head unless otherwise noted as Square Drive.

#### SMALL PACKS - FULL CARTONS ONLY

Bugle Head. Black or Unichrome (highly polished zinc).

Order by Box.

Code	Size	Color	Box	List/Box
FTPB100	1" x 7	Black	100 ea.	\$ 4.63
FTP100W	"	Black	1000	33.75
FTP100WU	"	Unichr.	1000	32.49
FTPB125	1-1/4" x 7	Black.	100	5.24
FTP125W	"	Black	1000	38.82
FTP125WU	"	Unichr.	1000	37.33
FTP125WSQ	" Sq Dr.	Black	1000	37.65
FTPB162	1-5/8" x 7	Black	100	6.18
FTP162W	"	Black	1000	48.66
FTP162WU	"	Unichr.	1000	48.66
FTP162WSQ	" Sq Dr.	Black	1000	46.73
FTPB200	2" x 7	Black	100	7.88
FTP200W	"	Black	1000	60.60
FTP200WU	"	Unichr.	1000	60.24
FTP200WSQ	" Sq Dr.	Black	1000	60.16
FTPB225	2-1/4" x 8	Black	100	10.51
FTP225W	"	Black	500	37.61
FTPB250	2-1/2" x 8	Black	100	12.47
FTP250W	"	Black	500	46.79
FTP250WU	"	Unichr.	500	48.61
FTP250WSQ	" Sq Dr.	Black	500	43.68
FTPB300	3" x 8	Black	100	14.69
FTP300W	"	Black	500	53.72
FTP300WU	"	Unichr.	500	55.95
FTP300WSQ	" Sq Dr.	Black	500	49.74

#### BULK PACK - FULL CARTONS ONLY

Bugle Head. Black or Unichrome (highly polished zinc).

Order by Box.

Code	Size	Color	Box	List/Box
FTP125B	1-1/4" x 7	Black	8000	\$ 286.19
FTP125BU	"	Unichr.	8000	285.88
FTP162B	1-5/8" x 7	Black.	5000	225.63
FTP162BU	"	Unichr.	5000	215.19
FTP200B	2" x 7	Black	3500	193.22
FTP200BU	"	Unichr.	3500	200.60
FTP250B	2-1/2" x 8	Black	2500	219.13
FTP250BU	"	Unichr.	2500	227.90
FTP300B	3" x 8	Black	2000	186.81
FTP300BU	"	Unichr.	2000	199.78
FTP300BSQ	" Sq. Dr.	Black	2000	201.76



## FASTAP SCREWS

### FASTAP PLUS DURACOAT XT EXTERIOR SCREWS

Silver Duracoat XT all-weather screws for exterior use. Self-Drilling and Self-Countersinking.

Far outlasts zinc fasteners on decks, construction, marine, etc....45° threads. Phillips head with nibs.



Self-Drilling and Toughened to Bend without Breaking

Full cartons only.  
Order by Box.

Small Pack	Size	Box	List/Box
DAC138	1-3/8 x 8	100	\$ 8.97
DAC200	2 x 8	100	12.61
DAC225	2-1/4 x 9	100	16.34
DAC250	2-1/2 x 9	100	17.16
DAC300	3 x 9	100	19.82
DAC334	3-3/4 x 10	50	19.99
DAC450	4-1/2 x 10	50	28.71
DAC500	5 x 10	25	19.82
DAC600	6 x 10	25	28.58

Whs Pack	Size	Box	List/Box
DAC134W	1-3/4 x 8	1000	\$ 81.17
DAC138W	1-3/8 x 8	1000	66.62
DAC200W	2 x 8	1000	95.98
DAC250W	2-1/2 x 9	500	72.07
DAC300W	3 x 9	500	79.76
DAC334W	3-3/4 x 10	250	88.15
DAC450W	4-1/2 x 10	250	125.94
DAC500W	5 x 10	250	174.20
DAC600W	6 x 10	250	226.15

Bulk Pack	Size	Box	List/Box
DAC134B	1-3/4 x 8	5000	\$ 381.12
DAC138B	1-3/8 x 8	7000	402.63
DAC250B	2-1/2 x 9	2500	335.26
DAC300B	3 x 9	2000	323.46
DAC334B	3-3/4 x 10	1500	447.06
DAC450B	4-1/2 x 10	1000	485.35
DAC600B	6 x 10	800	693.11

### FASTAP MELAMINE SCREWS



Unique design joins melamine without predrilling. The Flat Head screws have nibs for a flush fit. All with Phillips drive. Unichrome finish.

Warehouse Pack: 1000 per box, Order by Box.

Code	Size	Box	List/Box
MEL100W	1 x 8	1000	\$ 41.24
MEL125W	1-1/4 x 8	1000	50.00
MEL138W	1-3/8 x 8	1000	49.98
MEL158W	1-5/8 x 8	1000	64.79
MEL200W	2 x 8	1000	74.65

### FASTAP TRIM HEAD FINISHING SCREWS



Gold in color. Self-drilling and self-countersinking. With 45° threads. Square Drive. Full boxes only.

Order by Box.

Code	Size	Box	List/Box
B150TTSQ	1-1/2 x 6	100	\$ 6.15
FTP150TTWSQ	1-1/2 x 6	1000	43.60
B225TTSQ	2-1/4 x 7	100	8.41
FTP225TTWSQ	2-1/4 x 7	1000	61.82
FTP225TTBSQ	2-1/4 x 7	3000	187.63
FTP300TTBSQ	3 x 8	2000	208.90

### FASTAP BIT TIPS



Code	Description	Ctn	List/bg
PBT #2	Phil. Hd. 2 ea/bag For 1" - 3" Screws	10 bgs	\$ 1.33
PBT #3	Phil. Hd. 1 ea/bag For 3-1/4" to 6" Screws	10	.61
SBT #1	Sq. Hd. 2 ea/bag For Trim Hd. Screws	10	1.21
SBT #2	Sq. Hd. 2 ea/bag For 1" - 3" Screws	10	1.33



## QUICKSCREWS

## SCREWS

### TRUSS HEAD MACHINE SCREWS

Quickscrews

For knobs and pulls.  
Phillips/Slotted Combo.  
Zinc Plated.



Code	QS #	Length	Ctn	List/C
C832-12	1206	1/2"	100	\$ 3.43
C832-58	1207	5/8"	100	4.67
C832-34	1208	3/4"	100	4.95
C832-78	1209	7/8"	100	4.28
C832-1	1196	1"	100	4.83
C832-118	1211	1-1/8"	100	5.94
C832-114	1212	1-1/4"	100	7.10
C832-138	1213	1-3/8"	100	6.98
C832-112	1214	1-1/2"	100	6.36
C832-158	1215	1-5/8"	100	7.14
C832-134	1216	1-3/4"	100	7.88
C832-2	1218	2"	100	7.36

### Bulk

313	313	1-1/8"	6500	33.63/M
QS314	314	1-1/4"	5500	36.83/M
317	317	1-5/8"	4000	47.61/M
318	318	1-3/4"	4000	39.96/M

### METRIC TRUSS HEAD MACHINE SCREWS

Quickscrews

For knobs and pulls.  
Phillips/Slotted Combo.  
Zinc Plated.



Code	Size	Ctn	List/C
10950	M4 x 25mm (1")	100	\$ 8.15
10952	M4 x 35mm (1-3/8")	100	5.75
10953	M4 x 38mm (1-1/2")	100	6.15
10955	M4 x 45mm (1-3/4")	100	8.98

### BREAKAWAY TRUSS HEAD MACHINE SCREW

Quickscrews

Breakaway machine screw with Truss head and Phillips/Slotted combo drive. Screws have 4 small Notches. Requires pliers to snap off at desired length. Zinc.



Code	Size	Ctn	List/M
8903	#8-32 x 1-3/4"	1000	\$ 62.50
8892	M4 x 45mm	1000	72.50

### DRAWER SLIDE SCREWS

Phillips Truss Head,  
Type AB Thread  
Size: #8 x 7/16"  
(Replaces 716-8AC)



#229

Code	Color	List/C
229	Zinc	\$ 2.17
11549	Black	1.82
12649	White	5.03

Phillips Low Profile Pan Head,  
Type A Thread, Zinc.  
Size: #6 x 7/16"



#11572

Code	List/C
11572	\$ 2.35

Combo Truss Head,  
Coarse Thread, Zinc.  
Size: #8 x 7/16"



#10255

Code	List/M
10255	\$ 18.40

Phillips Truss Head,  
Coarse Thread, Zinc.  
Size: #8 x 7/16"



#4460

Code	List/C
4460	\$ 1.96

Phillips Round Washer Head,  
Zinc, Low Profile

Code	Size	Ctn	List/M
5213 (Bulk)	#8 x 7/16"	20000	\$ 19.54
8810	#8 x 7/16"	1000	28.54
4688	#8 x 1/2"	14000	20.06





## SCREWS

### DECORATIVE HINGE SCREWS

Phillips Drive



Various finishes and head sizes.

Code	Description	Finish	List/M
12-5 PHFT-AB	1/2" x 5 Flat Hd	Ant. Brass	\$ 10.30
12-5 PHFT-BB	1/2" x 5 Flat Hd	Brt. Brass	9.64
12-6 PHFT-AB	1/2" x 6 Flat Hd	Ant. Brass	13.53
58-6 PHOT-AB	5/8" x 6 Oval Hd	Ant. Brass	16.60
58-6 PHFT-AB	5/8" x 6 Flat Hd	Ant. Brass	15.01

### ROUND WASHER HEAD COMBO DRIVE

#8 x 3/4" Round Washer Head,  
#2 Combo Drive, Coarse Thread,  
Type 17 Auger Point, Zinc



Code	Size	Ctn	List/M
8883	#8 x 3/4"	10000	\$ 31.13

### DRAWER SOCKET SCREWS

Pan head, sharp tipped, deep  
thread screw for rear drawer  
mounting sockets. Phillips drive.



Code	Drive	Size	Ctn	List/M
165	Phillips	#8 x 3/4"	100	\$ 29.36

With Type 17 Auger Point for quicker penetration:

Code	Drive	Size	Ctn	List/M
8085	Phillips	#8 x 5/8"	12000	\$ 26.93
8086	Phillips	#8 x 3/4"	1000	30.66
13580	Square	#8 x 3/4"	1000	32.86

Truss head, sharp tipped, deep  
thread screw for rear drawer  
mounting sockets. Phillips drive.



Code	Drive	Size	Ctn	List/M
6802	Phillips	#8 x 3/4"	10000	\$ 28.64
7892	Phillips	#8 x 5/8"	10000	32.96



### COARSE THREAD WOOD SCREWS

Quickscrews

Flat head phillips wood screws for hinge  
cups, baseplates, drawer slides, etc. Coarse  
thread for better holding power. Sharp point  
for easy penetration into melamine.



ZC: Zinc Plated, NP: Nickel Plated, BL: Black

Code	QS #	Finish	Size	Ctn	List/M
5-12FPDT	109	ZC	1/2" x 5	40000	\$ 16.83
6-12FPDT*	9526	ZC	1/2" x 6	25000	15.42
114		ZC	1/2" x 6	25000	16.20
11322		NP	5/8" x 5	30000	16.09
6-58FPDT*	9501	ZC	5/8" x 6	25000	15.24
116		ZC	5/8" x 6	25000	12.90
10506		NP	5/8" x 6	25000	20.28
6-58FPDT-BL	6251	BL	5/8" x 6	5000	13.13
7-58FPDT	9223	NP	5/8" x 7	5000	27.57
126		NP	5/8" x 7	20000	20.91
(7-58FPDT Bulk)					
8-58FPDT	127	ZC	5/8" x 8	14000	22.74
6-34FPDT*	9594	ZC	3/4" x 6	20000	17.14
7-34FPDT	3368	NP	3/4" x 7	500	34.33
10166		NP	3/4" x 7	20000	24.69
(7-34FPDT Bulk)					
8-34FPDT	5790	ZC	3/4" x 8	1000	23.47
6-1FPDT	123	ZC	1" x 6	13000	21.06
7-1FPDT	9218	NP	1" x 7	1000	29.37

\*Head OD .275

### COARSE THREAD WOOD SCREWS

Grass



Phillips Flat Head. Nickel plated. 500/bag.  
One bag per carton. Sold in full bags only.

Code	Size	List/bag
81014	1/2" x 6	\$ 32.21
81001	5/8" x 6	36.17
81003	3/4" x 6	35.01
81004	1" x 6	35.28



## FLAT HEAD WOOD SCREWS

### SQUARE DRIVE COARSE THREAD WOOD SCREWS

Quickscrews

For Slides and Hinge Baseplates.  
#2 Square Drive, Flat Head  
Type 17 Auger Point. Zinc plated.



Code	Size	Ctn	List/M
13465	1/2" x 6	25000	\$ 19.81
13466	5/8" x 6	25000	17.13
13467	3/4" x 6	20000	21.70
13562	1" x 6	1000	22.44

### PAN HEAD WOOD SCREWS

Quickscrews

Phillips Pan Head.  
Coarse Thread.



Code	Size	Finish	Ctn	List/M
58-6 PHDT	5/8" x 6	Zinc	25000	\$ 15.80
12-6 PHDT	1/2" x 6	Zinc	30000	25.19
163	1/2" x 8	Zinc	15000	21.31
147	5/8" x 8	Black	12000	29.14
148	3/4" x 8	Black	10000	22.29
150	1" x 8	Black	9000	28.62
58-10 PHDT	5/8" x 10	Zinc	1000	56.31
7635	1" x 10	Zinc	500	List/C \$ 7.96

### PHILLIPS PAN HEAD TYPE 17 SCREWS

Quickscrews

# 12-8 X 3/4" Phillips Pan Head Coarse Thread  
Type 17 Zinc Plated Screws.

Can be used with Heavy Duty Workstation  
Support Brackets and the Heavy Duty Speed-  
brace Stealth Brackets (see pages 1409, 1411).



Code	Description	Ctn	List/C
9807	# 12-8 X 3/4" Phillips Pan Head	100	\$ 6.47

### PHILLIPS FLAT HEAD WOOD SCREWS

Quickscrews

Used for hardwoods where attaching  
close to the edge is required.



Pack: 1000 ea/box. Full Boxes Only.

Code	Size	Ctn	List/M
QS6176	1/2" x 4	1000	\$ 19.65

### FLAT UNDERCUT HEAD SCREWS

Quickscrews

Phillips Drive, Flat Undercut Head  
Coarse Thread Type 17 Zinc Plated  
Screws. Sits flush in countersunk holes.



Code	Size	Finish	Ctn	List/M
6057	5/8" x 6	Zinc	25000	\$ 16.35

### PHILLIPS FLAT HEAD WOOD SCREWS

Pack: 100 ea/box.  
Full Boxes Only.



Zinc Plated  
Steel

Code	Size	List/C
12-5 PHFW	5 x 1/2"	\$ 4.72
12-6 PHFW	6 x 1/2"	7.44
58-4 PHFW	4 x 5/8"	7.37
58-6 PHFW	6 x 5/8"	6.02
34-6 PHFW	6 x 3/4"	6.99
34-7 PHFW	7 x 3/4"	13.25
34-8 PHFW	8 x 3/4"	9.95
112-6 PHFW	6 x 1-1/2"	5.66
112-8 PHFW	8 x 1-1/2"	8.57
112-10 PHFW	10 x 1-1/2"	9.41
2-6 PHFW	6 x 2"	7.04
2-8 PHFW	8 x 2"	15.54
2-10 PHFW	10 x 2"	8.84
212-10 PHFW	10 x 2-1/2"	13.56
212-12 PHFW	12 x 2-1/2"	38.85
3-10 PHFW	10 x 3"	21.12
3-12 PHFW	12 x 3"	29.00



## TAPPING SCREWS

### PHILLIPS FLAT HEAD TAPPING SCREWS



Phillips Flat Head



Zinc Plated Steel

Pack: 100 ea/box. Full Boxes Only.

Code	Size	List/C
38-6 PHFT	6 x 3/8"	\$ 4.06
12-4 PHFT	4 x 1/2"	9.72
12-6 PHFT	6 x 1/2"	5.16
12-8 PHFT	8 x 1/2"	5.22
12-10 PHFT	10 x 1/2"	12.51
58-6 PHFT	6 x 5/8"	4.82
58-8 PHFT	8 x 5/8"	5.15
58-10 PHFT	10 x 5/8"	10.61
34-4 PHFT	4 x 3/4"	8.11
34-6 PHFT	6 x 3/4"	6.76
34-8 PHFT	8 x 3/4"	14.47
34-10 PHFT	10 x 3/4"	12.24
34-12 PHFT	12 x 3/4"	11.23
1-6 PHFT	6 x 1"	7.94
1-8 PHFT	8 x 1"	7.89
1-10 PHFT	10 x 1"	7.77
1-12 PHFT	12 x 1"	11.41
114-6 PHFT	6 x 1-1/4"	7.34
114-8 PHFT	8 x 1-1/4"	8.52
114-10 PHFT	10 x 1-1/4"	11.18
112-8 PHFT	8 x 1-1/2"	14.36
112-10 PHFT	10 x 1-1/2"	14.28
2-8 PHFT	8 x 2"	12.10
2-10 PHFT	10 x 2"	15.71

### PHILLIPS PAN HEAD TAPPING SCREWS



Phillips Pan Head



Zinc Plated Steel

Pack: 100 ea/box. Full Boxes Only.

Code	Size	List/C
38-4 PHPT	4 x 3/8"	\$ 4.51
38-6 PHPT	6 x 3/8"	4.22
38-8 PHPT	8 x 3/8"	4.70
12-4 PHPT	4 x 1/2"	3.99
12-6 PHPT	6 x 1/2"	5.11
12-8 PHPT	8 x 1/2"	6.18
12-10 PHPT	10 x 1/2"	6.51
58-4 PHPT	4 x 5/8"	4.34
58-6 PHPT	6 x 5/8"	6.01
58-8 PHPT	8 x 5/8"	7.25
58-10 PHPT	10 x 5/8"	16.46
34-4 PHPT	4 x 3/4"	5.28
34-6 PHPT	6 x 3/4"	6.60
34-8 PHPT	8 x 3/4"	11.43
34-10 PHPT	10 x 3/4"	12.50
34-12 PHPT	12 x 3/4"	13.10
9807 (type 17)	12 x 3/4"	6.47
1-6 PHPT	6 x 1"	5.25
1-8 PHPT	8 x 1"	7.94
7635	10 x 1"	7.96
1-14 PHPT	14 x 1"	19.52
114-6 PHPT	6 x 1-1/4"	6.45
114-8 PHPT	8 x 1-1/4"	7.66
114-10 PHPT	10 x 1-1/4"	9.24
112-8 PHPT	8 x 1-1/2"	8.21
112-10 PHPT	10 x 1-1/2"	11.31
134-12 PHPT	12 x 1-3/4"	19.34
2-10 PHPT	10 x 2"	15.45

**18 Ant. Brass  
Phillips Flat Head  
Tapping Screws**



Code	Size	Ctn	List/M
12-5 PHFT-AB	5 x 1/2"	25000	\$ 10.30
58-6 PHFT-AB	6 x 5/8"	20000	15.01

### Bulk Phillips Pan Head Tapping Screws

Code	Size	Ctn	List/M
166	8 x 1"	9000	22.60
167	8 x 1-1/4"	9000	27.27
168SG	8 x 1-1/2"	6000	28.65

## EURO SCREWS

### GRASS EURO SCREWS

Phillips Flat Head



Code	Length	Ctn	List/M
83001	7.5mm	500	\$ 112.22
81015	13mm	500	129.93
83000	18mm	500	165.97

### GRASS EURO SCREW APPLICATIONS

Use Grass Euro screws with their metal drawer systems. (Some generic Euro screws go right through the cabinet member.) Grass Euroscrews are phillips drive.

The 13mm is most common. The 18mm (83000) are for use on drawer guides with "Life Saver"  shaped spacers (seldom used).

The 7.5mm is used where either drawer guides or Euro hinge base plates are used back to back on a "common wall".

Grass hinge base plates don't always come with prefixed Euro-screws. You can select the one which serves your need - i.e., 13mm on standard configurations, or 7.5mm for back to back mounting.

### SALICE EURO SCREWS

Pozi Drive Pan Head

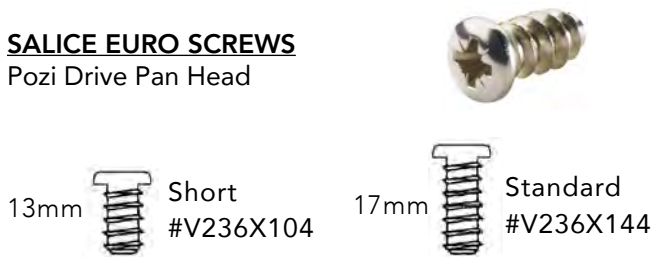

Code	Length	Ctn	List/C
V236X104	13mm	100	\$ 11.15
V236X144	17mm	100	12.20
V136X156 (titanium finish)	14.5mm	100	17.91

### SALICE EURO SCREWS

Salice Euro screws have a stock pan head shape which lends itself only to Salice hinges. Use short 10mm screw for common wall applications. Salice Euro-screw plates always come with prefixed screws unless they are removed at the shop.

### GENERIC EURO SCREWS

Generic Euro Screws are a lower cost version of the Grass type. Quality is less consistent. Most are Pozi-drive. They are in general used for Euroslides and for ball-bearing slides.



### EURO SCREWS



Code	Head dia x Length	Drive	Ctn	List/M
1220	6.3mm x 10mm	Pozi	1000	\$ 38.28
1097*	6.3mm x 10mm	Pozi	10000	32.78
13358	6.3mm x 11.5mm	Sq #2	10000	25.47
227-	6.3mm x 13mm	Pozi	10000	38.07
10589	6.3mm x 13mm	Sq #2	10000	36.61
3500	6.3mm x 13mm	Phil	10000	39.49
11735	6.3mm x 14.5mm	Pozi	1000	44.16

\*Full Carton Only

Baseplates



Common Wall

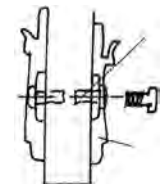

Ball Bearing Slides

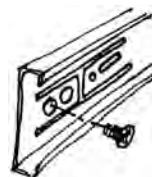

Euro Slides

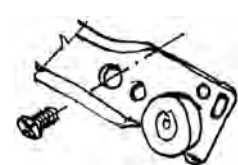

## SCREWDRIVER BITS

- X - Prefix for extra hardness bits to be used for driving sheet metal or case hardened screws.
- I - Prefix for intermediate hardness bits to be used for driving heat-treated screws and for impact use.



1" Standard Length



Long Length

### FOR PHILLIPS SCREWS - 1/4" Hex Insert 440 Series

Code	Pt. Size	O.A. Length	List/ea
I440-1	1	1"	\$ 1.30
X440-1	1	1"	1.43
QS440-2-I	2	1"	2.31
X440-2	2	1"	1.74
I440-3	3	1"	2.90
X440-3	3	1"	1.64
I440-22	2	2"	5.71
X440-22	2	2"	3.04
X440-23	2	3"	6.27
X440-215	2	2-1/2"	2.41

### FOR POZI DRIVE SCREWS 1/4" Hex Insert, 440 Series

11769	2	1"	\$ .82
X440-3-PZD	3	1"	3.05
QS440-3-PZD	3	1"	1.87



### FOR PHILLIPS SCREWS

1/4" Hex Shank, 446 Series

I446-2	2	1"	\$ 1.83
X446-1	1	1"	1.61
X446-2	2	1"	1.71
QS446-2-I	2	1"	2.17
11759	2	1"	.86
11760	2	1"	1.23



### FOR PHILLIPS SCREWS

5/16" Hex Shank  
480 Series

I480-2	2	1-1/4"	\$ 4.50
--------	---	--------	---------



## SQUARE DRIVE BITS



1/4" Hex Insert



1/4" Hex Power Drive

Code	Description	Ctn	List/ea
11774	1" Square Dr, #1	10	\$ .58
11778	1" Square Dr, #2	10	1.41
QS954-2-I	1-15/16" Square Dr, #2	10	3.93
QS954B-2-I	3-1/2" Square Dr, #2	10	7.57

### FOR PHILLIPS SCREWS

1/4" Hex Power Drive



**QS492-I**  
Phillips Power Magnetic  
Impact Drive Bit

**11905**  
Phillips Power Bit. Use  
to drive Phillips screws  
with # 6, 7, 8, 10



**QS492B**  
Phillips Magnetic Power Bit.  
Used to drive Phillips screws  
with # 5, 6, 7, 8, 10

Code	Pt. Size	O.A. Length	List/ea
QS492-I	2	1-15/16"	\$ 1.63
11905	2	1-15/16"	3.27
QS492B	2	3-1/2"	5.67

### Note:

When a #2 bit is needed we recommend the #2 446 Apex series for #5, #6 and short to medium #8 screws (this bit is also known as a #2 recess bit). The 446 series is commonly used to mount drawer slides, face frame plates, and Amerock style hinges.

The #2 440 Apex series is recommended for driving #8 and #10 screws (the 440 will fit smaller screws too, it just performs best on larger screw heads).



## SCREWDRIVER BITS

### MAGNETIC POWER BITS

Quickscrews



6" Power Bit. Available in Phillips or Square Drive.

Pack: 10 ea.

<u>Code</u>	<u>Description</u>	<u>List/ea</u>
12694	6" Phillips Drive #2	\$ 6.22
12698	6" Square Drive #2	5.91

### SCREWDRIVER BIT

Square/Phillips Drive Combo Head



The 13113 combo head screwdriver bit has both Square drive and Phillips drive "teeth." Works well with the Quadrex white screws.

<u>Code</u>	<u>Description</u>	<u>List</u>
13113	Combo Head Bit	\$ 3.99

## BIT HOLDERS

### MAGNETIC BIT HOLDER



11794 or M490

Use With 1/4" Hex Insert Bit. Body Dia: 1/4"

<u>Code</u>	<u>Manufacturer</u>	<u>Overall Length</u>	<u>Pack</u>	<u>List/ea</u>
11794	Quickscrews	2-7/8"	1 ea.	\$ 9.88
M490	Apex	3"	1	28.50

### QUICK RELEASE MAGNETIC BIT HOLDER

Quickscrews



14203

Stainless Steel Magnetic Bit Holder use with any type insert bit works in any standard drill chuck - Quick Release & Super Magnetic. 1/4" x 3".

<u>Code</u>	<u>Description</u>	<u>List/ea</u>
14203	Quick Release Bit Holder	\$ 31.63

## CONNECTING SCREWS

### CONNECTING SCREWS

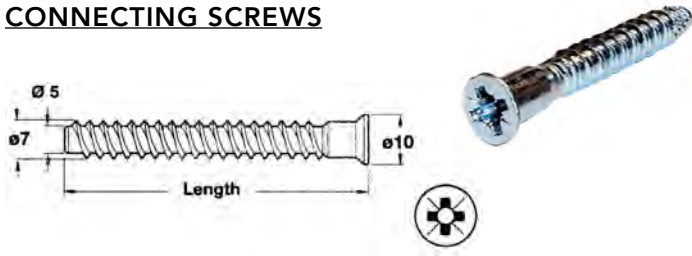

Zinc-plated, pozidrive with hole for cover cap, blunt tipped

Code	Shank	Length	Ctn	List/C
10552	5mm	50mm	3000	\$ 9.83
10752	7mm	50mm	2000	14.86

### STEP DRILL FOR CONNECTING SCREWS

Quickscrews



Drills 3 different diameters: 5mm, 7mm, 10mm.

Code	Description	List/ea
12793P	Step Drill Bit, High Speed Steel, USA	\$ 97.16

### HEX HEAD CONFIRMAT SCREW

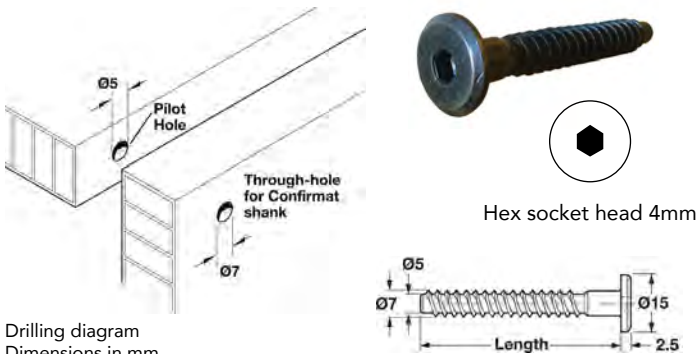

Code	Description	Ctn	List/C
264.47.138	Bronzed, 50mm	100	\$ 27.50

### CONNECTING SCREWS

QuickScrews Int'l

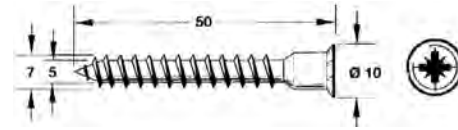

With nibs and a sharp point. Pozi Flat Head.  
 Size: 7mm x 50mm. Head Dia: 7.3mm - 7.5mm.  
 Use with cover caps.

Code	Description	Ctn	List/M
5502	7mm x 50mm	2000	\$ 103.14

### CONNECTING SCREWS

QuickScrews Int'l

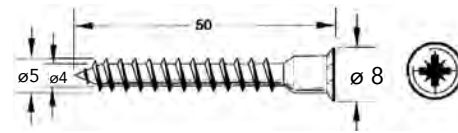

With nibs and a sharp point. Pozi Flat Head.  
 Size: 5mm x 50mm.

Code	Description	Ctn	List/M
13720	5mm x 50mm	4000	\$ 71.73

## DRAWER FRONT SCREWS

### DRAWER FRONT ADJUSTING SCREWS



Phillips Washerhead  
 Coarse Thread Screw

Code	QS#	Size	Ctn	List/M
8-1DFS	1047	1" x 8	7000	\$ 41.14
8-118DFS	2757	1-1/8" x 8	6000	42.95
8-114DFS	4103	1-1/4" x 8	6000	46.18

With Type 17 Auger Point for quicker penetration in hardwoods:

Code	QS#	Size	Ctn	List/M
8-118DFS-17	9024	1-1/8" x 8	6000	\$ 43.80
8-114DFS-17	9025	1-1/4" x 8	6000	48.17

Combo-Drive (Sq/Phil), Type 17 Auger Point:

Code	Size	Ctn	List/M
12625	1" x 8	7000	\$ 44.41
12626	1-1/8" x 8	6000	48.99
12627	1-1/4" x 8	6000	52.72

### TITUS DRAWER FRONT ADJUSTER

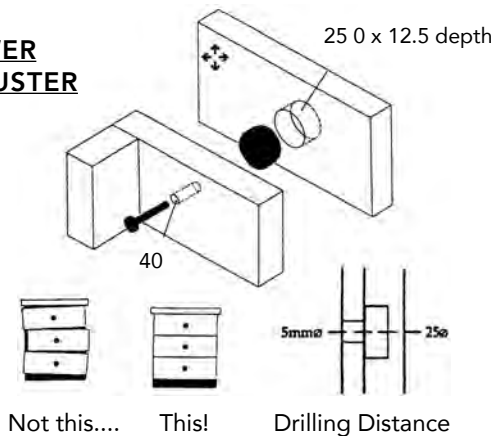

Use adjuster in pairs to provide alignment on fronts attached to four-sided drawers. 2mm of adjustment in vertical and horizontal directions. Nylon material. 100 per box (8/32" machine screws are not included).

Code	Description	Ctn	List/ea
6309	25mm adjuster	100	\$ .87

## FALSE FRONTS

### PUSH FIT SET

Allows panels to be mounted directly from the front. Panel component locks into the frame as the panels are pushed together. Holds heavy panels securely, yet the fasteners can be quickly released again without any special tools. Male/Female component set. For #8 wood screws.



Code	Description	Ctn	List/st
KEKU-P	Push-In Set, screw-on w/ #8 screws	100	\$ 3.00

### FALSE FRONT CLIPS/DOWELS

False Front Catch:  
 Metal Clip and Front Dowel



Code	Description	Ctn	List/C
FFS11	False Front Dowel	100	\$ 25.77
FFC11	Metal Clip	100	25.77

### FALSE FRONT CONNECTOR

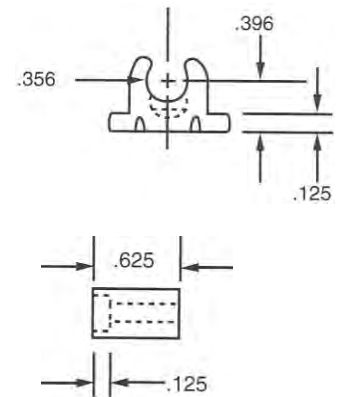
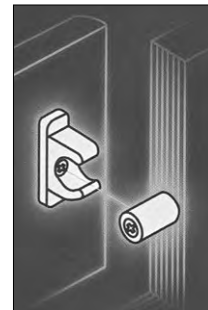

Use the T191 Snap Clip with the T190 dowel

Code	Description	Ctn	List/M
T191	Snap Clip, Clear	8000	\$136.94
T190	Dowel, Screw Size: #8 x 1 Pan Hd Phil, Clear	8000	121.02



## CABINET CONNECTORS

### TITUS CONNECTOR SCREWS

Pozi Drive, Funnel Head

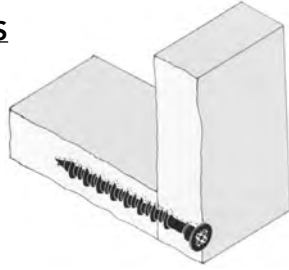

Excellent for cabinet and wall unit construction. The Hi-Lo thread and narrow shaft offer low bursting pressure and good holding performance. Hole Boring: Simple straight through or straight blind holes drilled from one side of the board only. Drill 3mm (1/8") dia. hole for screw shank. Use on 5/8" or 3/4" board. Case hardened carbon steel. Pozidrive; funnel head.

Code	Size	Ctn	List/M
00062PH	25mm x 8mm	10000	\$ 29.98
00071PH	33mm x 8mm	14000	40.24
00077PH	45mm x 8mm	10000	44.85
06077PH	50mm x 8mm	6000	67.32
06080PH	50mm x 11mm	6000	82.00

### TITUS SCREW COVER CAPS

Specifically designed for insertion into the head of the above screws. Simply knock into screw head with a hammer.



Code	Color	Ctn	List/M
01020TAO	Light Brown	1000	\$ 27.60
01020WAO	White	1000	22.62

### SCREW COVER CAPS



Flexible plastic screw caps give a flush finished look to surfaces. Flexible grooved pegs with hollow core ensure a firm hold on screw races. Use finger or hammer to tap into screw head. Fits any #2 square drive or pozi drive screws.

Bulk: Sold in Full Cartons only.

Code	Color	Ctn	List/M
5525-014B	Black	1000	\$ 81.40

### TITUS DOWEL & CAM CONNECTORS



### PUSH-IN DOWEL



5474-880

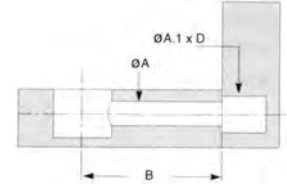

Push-in dowel with plastic expanding sleeve. Tool-free fixing of dowel into face boring cuts assembly time by 50%. Klix feature provides a strong, vibration proof connection. Dark Gray in color. Dimensions: A = 8mm, A.1 = 8mm B = 34mm, D = 12mm

Code	Description	Ctn	List/M
5474-880	Dowel, 8mm x 34mm	1000	\$ 188.99

### TITUS CAM



5656

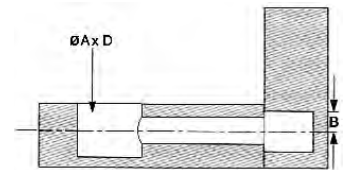

Suits all Titus dowels. Straight lower edge facilitates alignment and positioning during production. Klix feature provides a strong, vibration-proof connection. Die-cast zinc. Dimensions: A = 15mm, D = 14mm, B = 9.0-9.5mm

Code	Description	Ctn	List/M
5656ZN	Cam, 15mm x 14mm	2000	\$ 161.24

## QUICKFIT

### TITUS SYSTEM 6, QUICKFIT EXPANDO

20mm CamFix outrigger

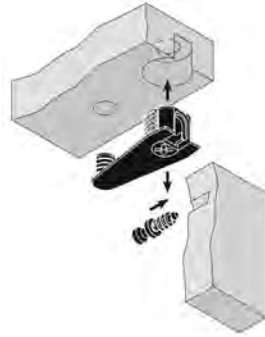
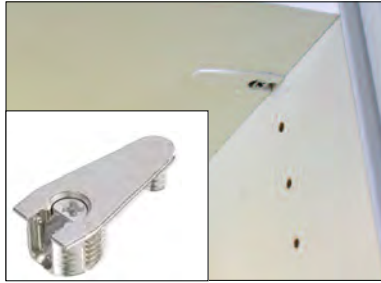

- Housing expands when cam is tightened: provides a tight joint
- Drop-on insertion of shelf panel
- All metal (stronger) or metal/plastic
- Strong vibration-proof connection with locking feature
- Face boring only - no edge boring required
- Angle drive feature on cam for driving comfort

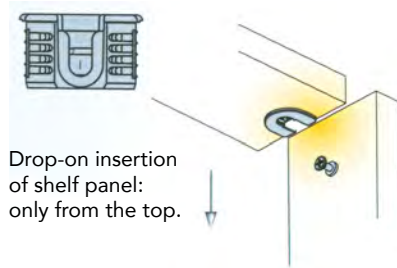
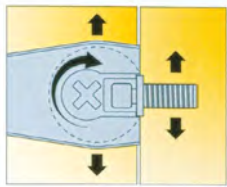

Drop-on insertion  
 of shelf panel:  
 only from the top.

Expanding housings and  
 dowels provide a tight joint.

Code	Drill Depth	Panel Thickness	Color	Ctn	List/ea
06439-835*	12.5mm	16mm (5/8")	Black	1250	\$.22
06439-877	12.5mm	16mm "	White	1250	.30
06439-841	12.5mm	16mm "	Almond	1250	.31
06439-898	12.5mm	16mm "	Brown	1250	.41
06397-835	14mm	19mm (3/4")	Black	1250	\$.29
06397-877	14mm	19mm "	White	1250	.33
06397-841	14mm	19mm "	Almond	1250	.32
06397-861	14mm	19mm "	Silver	1250	.27
06397-898	14mm	19mm "	Brown	1250	.29
06397-927*	14mm	19mm "	Candlelight	1250	.23
06457-847	14mm	19mm "	Nickel	500	2.05

Dowels not included - order separately.

\*Special order when out.

## CABINET CONNECTORS

### TITUS SYSTEM 6, QUICKFIT EXPANDO

Expanding Dowels and Double-ended Dowels

#### Expanding Dowels

Dowel Ø5

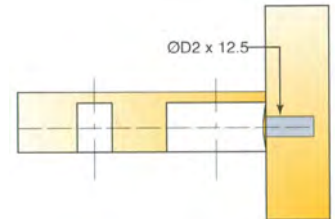
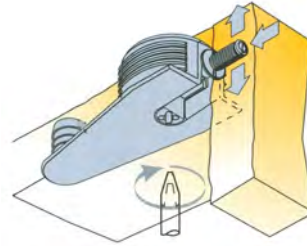

Code	Description	Ctn	List/ea
6408	Dowel, ø5	5000	\$.13

### TITUS EXPANDO WEDGEFIX-6 CONNECTOR

06472

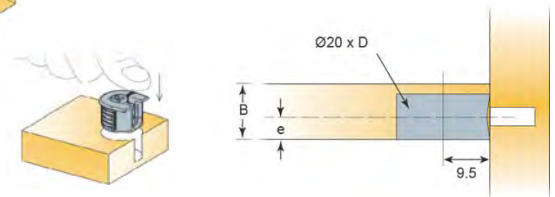
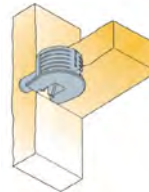

- All plastic connector without inner cam
- Wedgefix may be snapped into position on the dowel. It can be unsnapped, should the panel need to be relocated later.
- Corrosion-proof
- Use only push-in (tool-free) Quickfit-6 expanding dowels

Pack: 2500 each

Code	Description	Panel	Color	List/M
06472WA	Wedgefix Connector	18/19mm	White	\$ 249.91



## CONNECTORS

### TITUS SYSTEM 6, QUICKFIT EXPANDO

20mm Knock-in Housing, Non-outrigger



Drop-on (tool-free) housing is quick and easy to install. Housing is high grade nylon, inner cam made of die-cast zinc. For 18/19 panel thickness. When housing is pushed into underside of shelving, pozi-drive locking of cam may take place from above or below, and will expand inside panel on locking. Provides a strong, vibration-proof connection.

Code	Color	List/M
06387-835	Black	\$ 326.86
06387-841	Maple	316.14
06387-877	White	358.67
06387-898	Brown	372.44

### TITUS QUICKFIT DOWELS

For Expando-6 Housing



06406

Screw-in Dowel:

- Has 5mm Eurothread
- Integral skirt acts as positive stop during insertion



6416

Double-ended (Dogbone) Dowel:

- For 19mm board
- Push-in (tool-free) installation

These Zinc die-cast dowels are for Ø5mm system holes; they provide a strong, vibration-proof connection.

Code	Description	Ctn	List
06406	Screw-in Dowel	5000	\$ 93.26/M
6416	Double Dowel	2500	.14/ea

### 20mm CMT BORING BIT - RH

Carbide tipped boring bit. 20mm dia. 57.5mm overall length. Shank: 10mm outside dia.



Code	Description	List/ea
317.200.11	RH 20mm Boring Bit	\$ 45.53



### CABINEO CABINET CONNECTORS

For CNC

Signal White



Black



- One piece cabinet unit fitting - no edge drilling is necessary and no need for wooden dowels
- More efficient production, faster installation, higher clamping force
- Can be used with all kinds of CNC machines, including very simple 3 axis and nesting machines
- Shallow element of 10mm allows for panels from 12mm thickness



Install Cabineo into a drilled or routed shape



Preinstalled screw inside fitting is screwed into 5mm drill hole in corresponding workpiece.

#### Cabineo 8

For dividing panels from 16mm and corner joints from 12mm.

#### Cabineo 12

For dividing panels from 24mm and corner joints from 13mm.

Code	Description	Bx Qty	Net/bx
186310	Cab 8, Connector, Wht	500	\$ 200
186320	Cab 12, Connector, Wht	500	195
186321	Cab 12, Connector, Wht	2000	695
186331	Cab 12, Connector, Black	2000	695

### Cabineo Cover Caps

100 caps per pack, List \$12/pk



186350A  
Dark Grey



186350B  
Brown Beige



186350C  
Silver



186350D  
Dark Steel



186350F  
Window Grey



186350H  
Ivory



186350N  
Nickel



186350P  
Papyrus White



186350R  
Fawn Brown



186350S  
Signal White



186350T  
Black



186350W  
Pure White

## CONNECTORS



### P2 SYSTEM CONNECTORS

Use with Zeta P2 Joiners

See Page 2014 for  
**Zeta P2 Joiner machines**



### Clamex P

The Detachable, Eccentric Cam Connector slides into place--No Tools Required



- Fits into T-groove slot made with a Zeta P2 machine: Simply slide connectors in pre-cut slot, match up panels with built in alignment tabs, lock cam lever by a turn of a hex key.
- Joins any miter angle without glue or screws to create nearly invisible Ready To Assemble (RTA) connections.

#### Clamex P-14 - For Panels from 16mm 66 x 28 x 9.7mm

Code	Box	Net/Bx
145334	80 pr	\$ 135.20
145346	300 pr	458.35
145356	1000 pr	1364.75

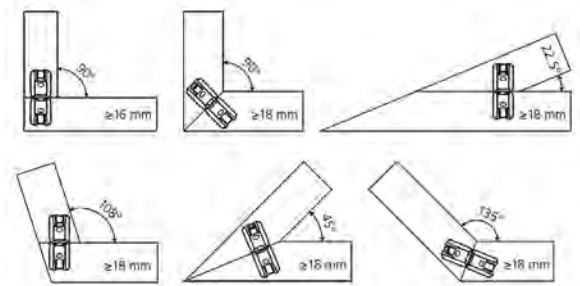

#### Clamex P-10 - For Panels from 13mm 52 x 19 x 9.7mm

Code	Box	Net/Bx
145372	80 pr	\$ 135.01
145373	300 pr	445.00
145374	1000 pr	1325.00

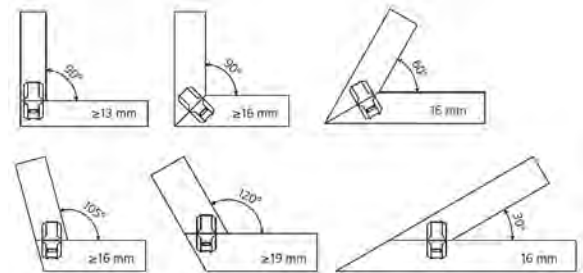

#### Clamex Flexus P-14

Detachable furniture connector like the Clamex P-14 above, but with flexible positioning pins.



- Flexible assembly sequence – Flexible positioning pins allow freely selectable assembly sequence
- Simple alignment – Pins align the workpiece and keep it in position
- Versatile assembly – Bevelled and movable positioning pins enable the tilting of the workpiece in both directions
- Installation of fixed shelves – Fixed shelves or vertical separators can be installed in an assembled cabinet unit
- Compatible with all Clamex P connector halves without levers – P-14 without lever, P-10 without lever and P-10 Medius without lever

Code	Box	Net/Bx
145315	80 pr	\$ 135.01
145316	300 pr	458.35

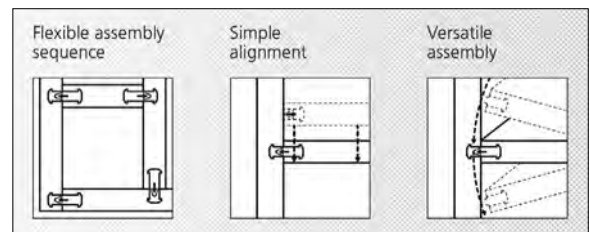



## CONNECTORS



### ZETA P2 continued P2 SYSTEM CONNECTORS

#### Tenso P

Glue Faster: Invisible  
Self-Clamping Glue Aid



A self-clamping fitting with three functions: alignment, clamping and connecting. The high clamping force allows work pieces to be glued without clamps or pressure. Anchors the work piece in just seconds, without tools.

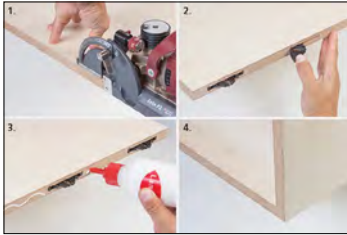

#### Tenso P-14 - For Panels from 13mm 66 x 28 x 9.7mm

Code	Box	Net/Bx
145415	80 pr	\$ 77.25
145425	300 pr	265.21



#### Tenso P-10 - For Panels from 12mm 52 x 19 x 9.7mm - Includes Preload clip

Code	Box	Net/Bx
145418	80 pr	\$ 95.00
145438	1000 pr	910.01



For Tenso accessories, see page 2016

### ZETA P2 continued P2 SYSTEM CONNECTORS

#### Bisco P

Alignment aid for Clamex & Tenso P-10 & P-14



An alignment element that is part of the Clamex P system. It is easily installed using the Zeta P2 or CNC as it fits easily into the P-system groove without changing the cutter. Bisco P is 7mm thick, made of thick plastic and used in combination with Clamex P. The element is not only used for alignment of panels but can be used for glueing, and increasing shear strength.

#### Bisco P-14 65 x 27 x 7mm

Code	Box	Net/Bx
145301	80 ea	\$ 40.18
145302	300 ea	105.00



7mm thickness

#### Bisco P-10 52 x 19 x 7mm

Code	Box	Net/Bx
145304	80 ea	\$ 42.00



#### Divario P-18

Self-clamping, invisible fitting for slide insertion.  
65 x 16 x 9.7mm

- Completely invisible joint
- Joins & clamps during insertion for perfectly closed joints
- Narrow element for the use in shelves from 19mm
- No resistance while inserting until shortly before building the clamping force
- Insertion of shelves after transport for lower transport weight
- Divario installation tool # 125500 sold separately (required for fixing the Divario in the workpiece)

Code	Box	Net/Bx
145550	80 pr	\$ 95.40
145560	300 pr	329.61

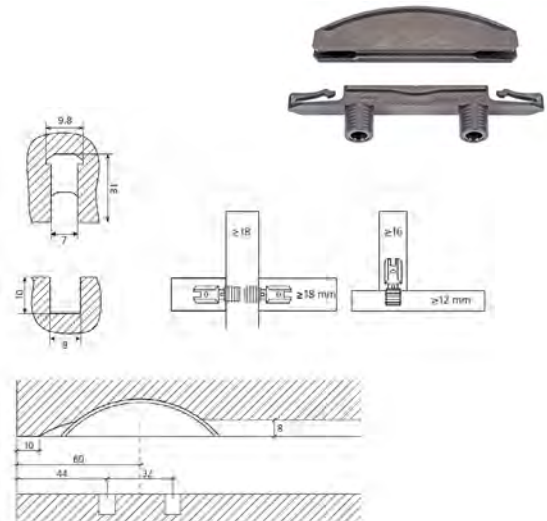



## PANEL CONNECTORS

### LAMELLO JOINTING BISCUITS

Beech



Oval jointing plates fit easily into slot & allow adjustment for perfect alignments without jigs. Dampness of glue swells plate to great strength. Made of compressed beech. Will join panels to 3/8" thick.

**Sold in Full Cartons only.**

Code	Size	Ctn	List/M
0LA	1-3/4" Plate	1000	\$ 89.40
10LA	2-1/8" Plate	1000	89.40
20LA	2-1/2" Plate	1000	92.98

### FASTenon CONNECTORS

Fastcap

FASTenon allows you to pull your joints together without clamps. The barbs bite into your material; holding your workpiece firmly together. Add a little glue inside each joint and it's even stronger. Also great for aligning components when assembling. 6mm x 38mm.



100 piece per pack, Sold per pack.

Code	Description	Pack	List/pk
FT-100	Fastenon Connectors	100	\$ 41.79

### SEX BOLTS

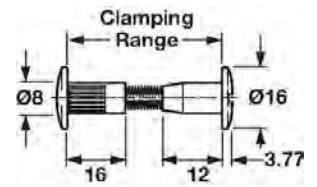

Complete fittings for connecting single furniture carcasses, base frames & constructions. For slotted or phillips. Material: steel, galvanized

Code	Thickness	Ctn	List/ea
267.07.902	32-38mm	100	\$ 1.50
267.07.903	36-42mm	100	.82

### PANEL CONNECTORS



1072393 + 1058986

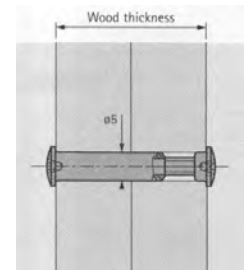

The two cabinet sides are fixed precisely by means of the long thread covers.

This panel connector has a high torque pressure. For 5mm diameter drilling. The thread cover is set back and makes it easier to screw in the connecting screw. The screw is an M4 x 15. All nickel plated steel.

Code	Thickness	Ctn	List/C
1058986	36-44mm (male)	2000	\$ 13.98
1072393	36-44mm (female)	2000	25.08

### PANEL CONNECTORS

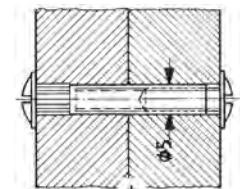

Order screw and sleeve separately. Made of nickel-plated steel. Screw is M4 x 15.

Code	Description	Ctn	List
7401M4X15	Screw, L=15mm	1000	\$ 13.44/C
749310435	Sleeve, 35mm	5000	313.41/M



# CONNECTORS



## STRIPLOX CONNECTORS

Striplox Concealed Connectors are used on solid timber, MDF, composite panels, aluminium and more. Easy to install, adjustable, and made from durable, heat stabilized glass reinforced nylon. Replaces visible screws, brackets, fittings and connectors and can be surface or recessed mounted in either vertical or horizontal positions.

### Striplox Pro 23

Ideal for installing modern timber battens, hanging cabinets, floating shelves, bookcases, artwork frames, mirrors and other panels. Strong, versatile, with a wide range of uses. Has a narrow profile for tidy concealment.

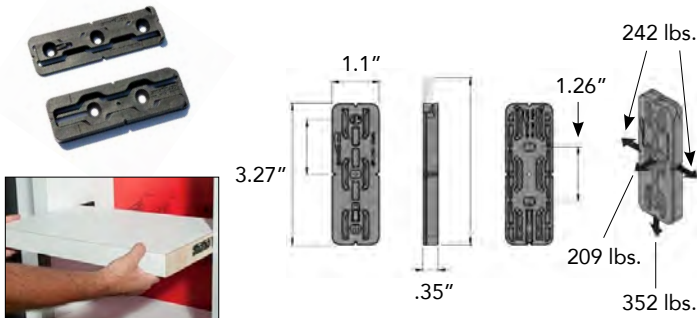

Code	Description	Ctn	List/pr
STRIPLOX-23	3.5" Panel Connector	100	\$ 3.95

### Striplox Pro 55

Same design as the Pro 23 but larger, for extra heavy duty requirements and a larger load capacity. Create unique key design elements such as feature batten ceiling designs, mantle piece installations plus numerous structural innovations.

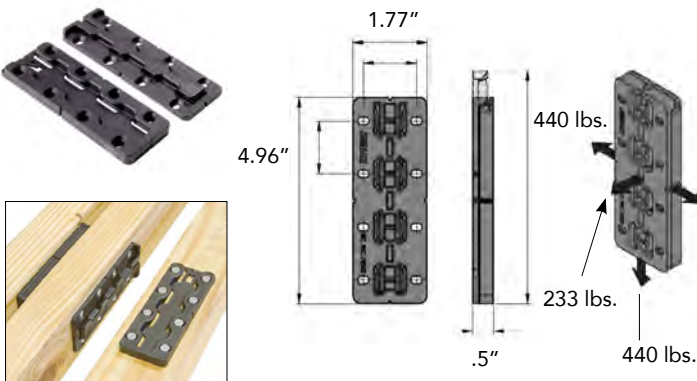

Code	Description	Ctn	List/pr
STRIPLOX-55	4.96" Panel Connector	50	\$ 5.95

### Striplox Clip 50

Designed with some smaller, precise applications in mind, this versatile and strong connecting system can be used in the tightest of places quickly and efficiently in commercial, architectural or domestic applications. It offers an advantage when being used on a less than perfectly square wall with its unique locking system and the option of permanent or reusable assembly. The locking key can also swivel for easy positioning.

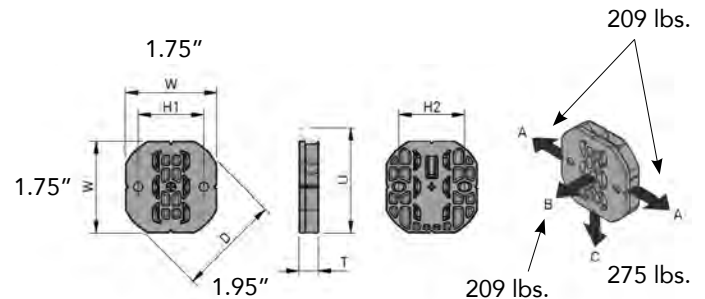

Code	Description	Ctn	List/pr
STRIPLOX-50	1.75" Panel Connector	100	\$ 4.50

### Striplox Jigs

The range of jigs aids installation to save time by accurately marking fixing center points. Red in color.



Code	Description	Ctn	List/st
STRIPLOX-23-JIG	Jig for Striplox-23	50	\$ 18.00
STRIPLOX-50-JIG	Jig for Striplox-50	50	18.00
STRIPLOX-55-JIG	Jig for Striplox-55	50	18.00

## CABINET CONNECTORS

### KOLBE KORNERS FOR PANEL DRAWER FRONTS

Fastcap



Mount Shaker drawer fronts and Euro drawer bottoms quickly and easily with Kolbe Korners!

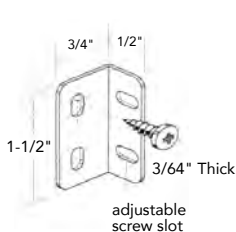
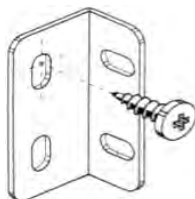
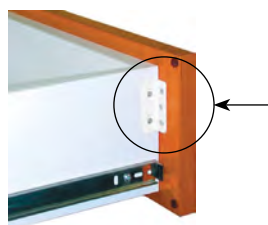

Metal Kolbe Korner



Plastic Kolbe Korner

Clean, easy and secure, the Kolbe Korner mounting brackets are used for 5-pc. Shaker style drawer fronts. Allows the drawer face to be easily mounted to the box. For Euro drawer slides they can be used as a brace for the drawer bottom.

**Metal Korners** - Screws and Korners sold separately.  
 Full Cartons only.

Code	Description	List/box
KK50PCMET.WH	Korner, White, 50 pack	\$ 57.03
KK50PCMET.TAN	Korner, Tan, 50 pack	57.04
KK.MET50SCR.WH	Wht Caps & Screws for 50 Korners	23.75
KK.MET50SCR.TAN	Tan Caps & Screws for 50 Korners	23.75

### Plastic Korners

Each 50 pack contains 50 Korners, 250 screws, 50 sets (2 pcs.) Fastcap screw covers.

Code	Description	List/pk
KK50PC.LM	Light Maple, 50 pack	\$ 33.39
KK50PC.WH	White, 50 pack	33.40

### CONNECTING BRACKETS



Used to install false drawer fronts in a frameless cabinet.

Sink Cabinet

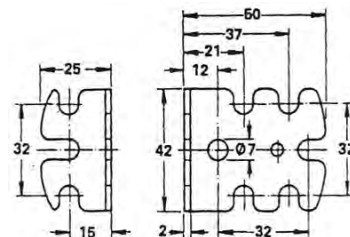
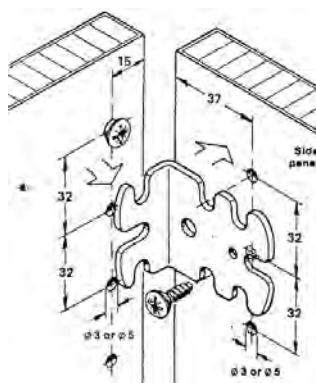

Typical installation of Universal brackets to secure:

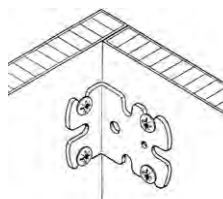

butt-mounted panels

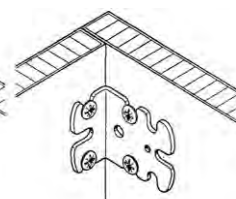

flush fitting panels

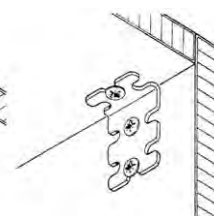

shelves or upper cross member

These universal connecting brackets are suitable for the assembly of carcass components and the installation of shelves and rear panels. This means that they can replace cupboard connectors, shelf supports and rear panel fasteners, with the result that a single type of fitting is required to construct fitted cupboards, shelf units, room dividers, etc.

Code	Ctn	List/ea
264.25.909	200 ea.	\$ 2.77



## COVER CAPS

### FASTCAP ADHESIVE-BACKED COVER CAPS

9/16" PVC or Real Wood



9/16" Dia.

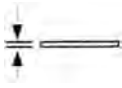

1/32" Thick



Cover caps are quick, durable, and self-adhesive. They stay in place and do not depend on the head of the screw for adhesion. The screw can be sunk far below the surface of the material and FastCaps will cover the hole effectively. Low profile so less likely to be noticed. PVC or Real Wood. Order by the sheet.

Pack: 53 caps per sheet, 1060 caps per box  
Please order in increments of 53!

<u>PVC</u>	<u>Color</u>	<u>List/C</u>
FC-WH	White	\$ 5.79
FC-AW	Antique White	5.80
FC-AL	Almond	5.80
FC-DG	Dark Gray	5.84
FC-LG	Light Gray	5.80
FC-BL	Black	5.80
FC-HRM	Hard Rock Maple	7.41
FC-NC	Nat. Cherry	8.86
FC-BC	Bourbon Cherry	7.11
FC-SC	Select Cherry	7.42
FC-PW	Pres. Walnut	7.41

Pack: 52 caps per sheet, 1040 caps per box  
Please order in increments of 52!

#### Real Wood

FC-RO	Red Oak	\$ 10.70
FC-WO	White Oak	10.70
FC-MAP	Maple	10.70
FC-CH	Cherry	10.68
FC-MAH	Mahogany	10.70
FC-VG	Vertical Grain Fir	10.70
FC-WA	Walnut	10.66
FC-WB	White Birch	10.70
FC-NB	Natural Birch	10.63
FC-AD	Alder	10.69

### FASTCAP 9/16" COVER CAPS 52 caps/sheet

<u>Real Wood, Finished</u>		<u>List/C</u>
FC-MPF	Maple, Finished	12.98
FC-CHF	Cherry, Finished	12.96
FC-WAF	Walnut, Finished	12.98
FC-WBF	White Birch, Finished	12.98

### 11/16" Dia. FASTCAPS

White PVC , 11/16" (18mm) dia.

36 caps per sheet, 20 sheets  
(720 caps) per box.

Order in increments of 36.



11/16" Dia.

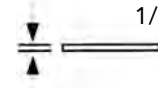

1/32" Thick

<u>Code</u>	<u>Color</u>	<u>List/C</u>
FC-1116-WH	White PVC	\$ 6.37

### **Custom Color Punch Tool and Kit**



Just need one cap and not 1,000? This tool is for you. Take any standard edgebanding or veneer, apply SpeedTape, punch your cap out and you are done.

See Page 1901 for full details.

### ADHESIVE-BACKED CASTLE COVER CAPS

Fastcap

Self-adhesive cover caps to cover holes cut by Castle Pocket Cutter machinery.

PVC colors or real wood veneer.  
9/16" x 2-1/2" caps, 1/32" Thick.

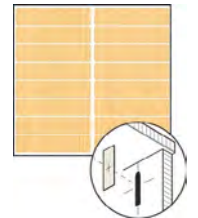

Pack: 16 caps per sheet, 320 caps per box  
Please order in increments of 16!

<u>PVC</u>	<u>Color</u>	<u>List/C</u>
FC-WH-CC	White	\$ 18.43
FC-BL-CC	Black	17.99
FC-NO-CC	Natural Oak	20.92
FC-HM-CC	Hard Rock Maple	23.06
<u>Real Wood</u>		
FC-MAP-CC	Maple	28.79
<u>Real Wood, Finished</u>		
FC-MP-CCF	Maple	39.10



## DOWEL PINS

### HARDWOOD SPIRAL DOWELS

Bulk



Code	Size	Ctn	List/M
38-112S	3/8" x 1-1/2"	15000	\$ 55.44
38-2S	3/8" x 2"	10500	86.90
38-212S	3/8" x 2-1/2"	10000	107.37
12-212S	1/2" x 2-1/2"	4000	164.79
12-3S	1/2" x 3"	5000	163.78
12-4S	1/2" x 4"	2700	249.61

### HARDWOOD MULTI-GROOVE DOWELS

Bulk



Code	Size	Ctn	List/M
38-2M	3/8" x 2"	13000	\$ 86.50
38-212M	3/8" x 2-1/2"	10000	80.40
12-4M	1/2" x 4"	3500	203.85
8MMX25MM	8mm x 25mm	36000	24.70
8MMX30MM	8mm x 30mm	19200	55.36
8MMX32MM	8mm x 32mm	17800	35.06
8MMX38MM	8mm x 38mm	22500	33.97

### PRE-GLUED MULTI-GROOVE DOWEL

Water Activated Glue

Blue in Color



Code	Size	Ctn	List/M
8MMX30MM-PG	8mm x 30mm	20000	\$ 48.50
8MMX32MM-PG	8mm x 32mm	20000	44.04
8MMX35MM-PG	8mm x 35mm	20000	49.00

### BAGGED SPIRAL GROOVED DOWEL PINS

500/Bag

Spiral grooved dowel pins in bags of 500.



Code	Size	List/bg
P52	5/16" x 2"	\$ 37.44
P62	3/8" x 2"	47.45
P6212	3/8" x 2-1/2"	51.80
P82	1/2" x 2"	59.23

### BAGGED SPIRAL GROOVED DOWEL PINS

100/bag  
25 bags/ctn.  
Assortable



Code	Size	List/bg
H42	1/4" x 2"	\$ 10.69
H5112	5/16" x 1-1/2"	8.97
H52	5/16" x 2"	10.19
H5212	5/16" x 2-1/2"	12.49
H6112	3/8" x 1-1/2"	9.32
H62	3/8" x 2"	10.03
H6212	3/8" x 2-1/2"	11.55
H82	1/2" x 2"	16.61

### MULTI-GROOVE DOWELS IN RETAIL BAGS

12 bags/box

Code	Size	Dowels/Bag	List/bag
F4114	1/4" x 1-1/4"	15	\$ 2.90
F5112	5/16" x 1-1/2"	15	2.89
F7212	7/16" x 2-1/2"	6	2.74

### TABLEPINS

100 ea/bag  
Full bags only.

3/8" x 1-1/4"



Code	Description	Ctn	List/C
HT	Birch Pine	5000	\$ 8.26





## BUTTONS & PLUGS

### SCREWHOLE BUTTONS

Mushroom



— Dia. —



#### In Bags of 100

Code	Dia.	Wood	Ctn	List/bg
H12B	1/2"	Birch	25 bags	\$ 18.02
H38B	3/8"	Birch	25	16.31
H38BO	3/8"	Oak	10	15.24

#### In Retail Bags - 12 bags per box

Code	Dia.	Wood	Buttons/ Bag	List/bg
F38B	3/8"	Birch	15	\$ 2.74
F12B	1/2"	Birch	15	2.89
F34B	3/4"	Birch	6	2.12
F10B	1"	Birch	5	2.12

### SCREWHOLE PLUGS

Flat Head



#### In Bags of 100

Code	Dia.	Wood	Ctn	List/bg
H12FP	1/2"	Birch	25 bags	\$ 8.68
H38FP	3/8"	Birch	25	15.76
H12FPO	1/2"	Oak	10	18.86

#### In Retail Bags - 12 bags per box

Code	Dia.	Wood	Buttons/ Bag	List/bg
F38F	3/8"	Birch	15	\$ 2.90
F12F	1/2"	Birch	15	2.89
F34F	3/4"	Birch	6	2.12
F10F	1"	Birch	5	2.12

### SCREWHOLE PLUGS

Round Head



#### In Retail Bags - 12 bags per box

Code	Dia.	Wood	Buttons/ Bag	List/bg
F38R	3/8"	Birch	15	\$ 2.12
F12R	1/2"	Birch	15	2.12
F34R	3/4"	Birch	6	2.12
F10R	1"	Birch	5	2.73

### HINGE HOLE REPAIR KIT

Correct drilling mistakes instead of replacing the entire door. Kit includes (2) 35mm plugs and (4) 8mm plugs. 35mm plugs are 1-1/2" thick. All plugs are tapered. Maple.



Code	Description	Ctn	List/bg
F3512SL	Hinge Hole Repair Kit	12	8.29

### WADDELL RAMIN HARDWOOD DOWELS

Color coded retail packs

Order in pieces,  
not per bundle.



Code	Size	Color	Pcs/ Bundle	List/C
18-36CCR	1/8" x 3'	Black	100	\$ 17.67
18-48CCR	1/8" x 4'	" "	100	34.24
316-36CCR	3/16" x 3'	Gray	100	21.44
14-48CCR	1/4" x 4'	Lt. Green	100	35.63
516-36CCR	5/16" x 3'	Red	100	33.35
38-36CCR	3/8" x 3'	Blue	100	48.61
38-48CCR	3/8" x 4'	" "	100	88.13
12-36CCR	1/2" x 3'	White	50	77.82
12-48CCR	1/2" x 4'	" "	50	133.61
34-36CCR	3/4" x 3'	Yellow	25	1.69/ea
34-48CCR	3/4" x 4'	" "	25	2.49/ea
1-36CCR	1" x 3'	Orange	10	5.67/ea
1-48CCR	1" x 4'	" "	10	4.23/ea
114-48CCR	1-1/4" x 4'	Dk. Green	9	6.52/ea



# SHIMS

## SHIMS

Available in Two Sizes

### 8" Pine Shim bundles:

12 shims per bundle,  
36 bundles per box  
Sold per box. (432 pcs.)  
Made of Pine.



Use for

- Window Installation
- Door Installation
- Counter Top Installation
- Cabinet Installation
- Floor Leveling
- Bath Fixture Leveling
- Leveling Appliances
- Stir Sticks
- Putty Applicators
- Squeaky Floors
- Perfect for retail

### 12" Shim bundles:

42 shims per bundle, 12 bundles per box  
Sold per box. (504 pcs.)

Made from  
BeddarWood™.  
Outperforms Pine  
and Cedar



Sold in Full boxes only

Code	Description	List/bx
SHIM-8	8" Pine Shims (432 pcs)	\$ 76.00
SHIM-12	12" Beddar Wood Shims (504 pcs)	102.25

## 8" COMPOSITE SHIMS "Shimmies"

Water, rot, and insect proof,  
with greater load bearing  
capacity than wood. Pre-scored  
design allows for easy consistent  
snap and resists splitting when nailed or screwed.



12 shims per bundle, 32 bundles per box.  
(384 shims per box, sold per box.)

Code	Description	List/bx
SHIMMIES	8" Composite Shims, Brown Plastic	\$ 120.31

## EXTRUDED GLASS/PANEL RETAINER

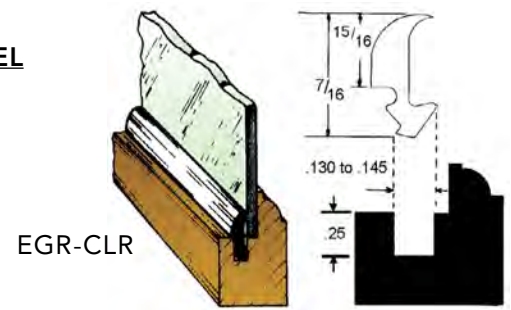

Clear, pliable plastic glass/panel retainer extrusion.  
Works well in cabinets with glass doors where back of  
door shows, and mirror-backed curios. 1000' per roll.  
Order by the foot.

Code	1'	100'	1000'
EGR-CLR	\$ 1.01/ft	\$ .64/ft	\$ .54/ft

Amana 3 Wing Slot Cutter with 3 Wing cutter, arbor  
& ball-bearing. 5/32" size also used for 'biscuit-joint'  
cutting.

Code	Kerf	Shank	List
53407 Slot Cutter	5/32"	1/4"	\$ 44.75
53407-1* Slot Cutter	5/32"	1/2"	44.75

\* Special Order

## SPACE BALLS



The inexpensive solution  
to your age-old problem:

- Centers solid panels
- Compresses if panels expand
- Stops panel rattle
- Helps eliminate cracking glue joints

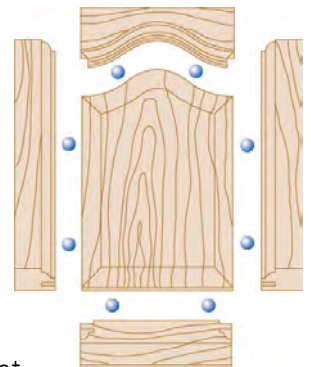

Space Balls will cut out most  
major call-backs on solid or flat  
panel doors.

Diameter: .26" - fits standard stile and rail cutters.  
8-10 Space Balls recommended per door.

Code	Quantity/Box	List/M
SB1M	1000 ea.	\$ 43.47
SB5M	5000 ea.	35.42

## CORNER BRACES

### CORNER BRACES

Made of wrought steel. Screw holes countersunk on inside. 1" size has two screw holes, 1-1/2" through 4" have four screw holes, 5" and 6" have six screw holes. Zinc plated. (Screws not included.)



Code	Size	Ctn	List
226-1	1"	10 cds, 4 ea/cd.	\$ 1.62 /cd
CB112	1-1/2"	100 ea.	.50 /ea
CB2	2"	500 ea.	1.00
226-2.5	2-1/2"	24 ea.	.96
226-3	3"	24 ea.	1.12
226-3.5	3-1/2"	6 cds, 4 ea/cd.	4.59 /cd
226-4	4"	10 ea.	2.11 /ea
226-5	5"	10 ea.	4.91
226-6	6"	12 ea.	5.43

### KV HANGER PLATE

#521



Overall: 13/16" x 2", Steel is 1/16" thick.

Keyhole shape hanger plate. Use with #10 x 3/4" flathead wood screws, not included.

Code	Ctn	List/ea
521ZC	100 ea.	\$ 1.28

### KV CORNER BRACES

Zinc plated stamped steel. Use with 3/4" No. 10 flat head wood screw. 100 per box.



Code	Size	List/ea
341	1" x 1"	\$ 1.45
342	2" x 2"	2.68

### MENDING PLATES



Wrought Steel, zinc plated. 4 Screw holes countersunk on inside. (Screws not included.)

Code	Size	Ctn	List/C
225-2.5	2-1/2"	48	\$ 57.78
225-3	3"	48	98.93
225-4	4"	48	95.96

1835

## GLASS CLIPS

### KV MIRROR & GLASS CLIPS

Screw-apart type glass clip. 1-1/2" wide x 1-1/8" high. For 1/4" or 5/16" glass. Anochrome. 10 per box with screws.

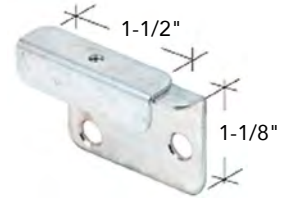

278 List \$ 10.33/ea

One piece type glass clip. 1-1/2" wide x 1" high. For 1/4" or 5/16" glass. Anochrome. 10 per box with screws.

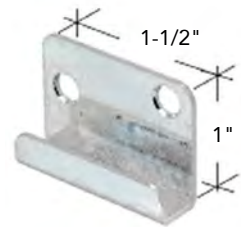

277KV List \$ 5.31/ea

### GLASS RETAINING CLIP



An easy-to-install way to secure glass or panels in cabinet doors or lighting fixtures. Variable for panel thickness, the rubber coating on the retaining screw protects glass. Statuary bronze finish.

Code	Description	Ctn	List/ea
2004EP	Glass clip retainer	1000	\$ .68

### BAINBRIDGE RABBETED GLASS CLIP

1810CL

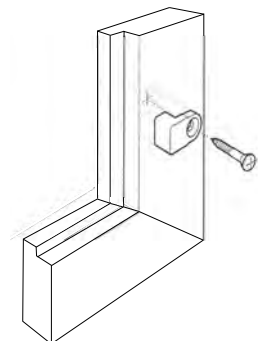

This glass clip is designed to hold glass into a rabbeted frame. Lip: 1/4". Clear in color.

Code	Ctn	List/C
1810CL	100 ea.	\$ 44.54



## BEDRAIL FITTINGS

### BEDRAIL FITTINGS

Can be used as a right or left hand fitting. Particularly sturdy version for hooked connection. Bright Steel. 10 sets per box (i.e. 40 hooks and 40 latching plates).

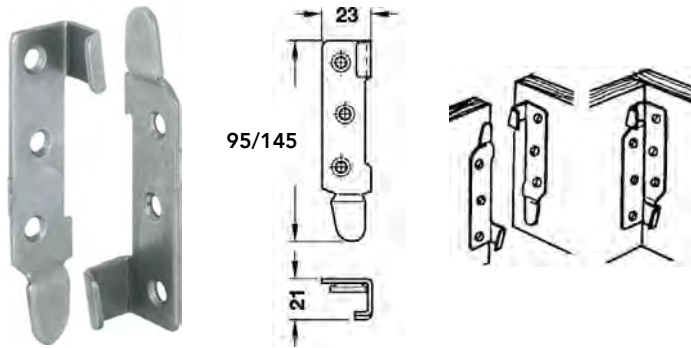

Available in two lengths: 95mm and 145mm. One set accommodates the four corners of the bed.

Code	Length	List/set
271.05.906	95mm	\$ 18.53
271.05.915	145mm	24.11

### PARKER BEDRAIL HANGERS



Plain wrought steel bed fasteners. Ideal for beds that have narrow rails. One set consists of one male hook piece and one female eye piece. Countersunk for 1-1/2" x 10 flat head screws.

24 sets/box.

Code	Size	List/set
1614-4	4"	\$ 16.29
1615-5	5"	14.13
1616-6	6"	15.79

## INSET DOOR STOPS

### INSET DOOR STOP

Tenn-Tex

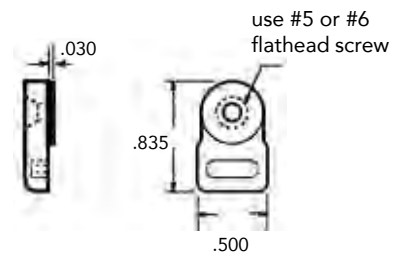

Door stop for cabinet inset doors. Clear in color. Uses #5 or #6 flathead screws (sold separately).

Code	Ctn	List/C
T230	1000 ea.	\$ 19.49

### INSET EURO DOOR STOP Fastcap "Cam" adjustable inset stop

ED-BR



ED-CL



Easy to Adjust

Screw Euro Door Stop at desired depth

Designed for use with inset cabinets. Simply screw inside cabinet and rotate to adjust where you want the cabinet door to shut.

Code	Color	Ctn	List/ea
ED-BR	Brown	100 ea.	\$ .27
ED-CL	Clear	100	.54

### DOOR STOP JIG

Fastcap

The Euro Door Jig is a compact tool used for accurate and repeatable placement of Euro Door Stops on cabinets. Door Stops sold separately (above).

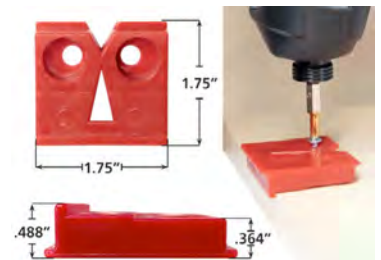

Code	Description	List/ea
ED-JIG	Euro Door Stop Jig	\$ 7.84

## FASTENERS

### KV TITE-JOINT FASTENERS

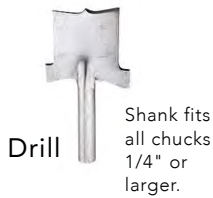

Drill guide accurately locates both hole positions in wood pieces. Designed for use on 3/4" stock.

Applies even, controlled pressure between joint members. Solid joint without glue. For 3/4" wood. Packed 100 or 25 per box. One installation drill and guide pack in each box. Zinc.

Code	Description	Ctn	List/ea
516-100*	Joint Fastener	100	\$ 4.91
516-25*	Joint Fastener	25	5.54
516-80	Tightening Assembly	100	3.40

\* Full Ctns. Only

### KV JOINT FASTENERS



Bolt 4" long. Thread Length: 3-1/2".  
 Plate Size: 7/16" x 3/16" x 1". Can be used in 5/8" wood. 100 complete fasteners per box.

Code	Description	Ctn	List/ea
513	Joint Fastener	100	\$ 2.42

### DRAW BOLT CONNECTOR



Easy to install fastener which makes a smooth, tight joint. Hex Head Bolt: 1/4-20 x 3-1/2".

Code	Description	Ctn	List/C
DRAW BOLTS	Hex Head Joint Bolt	500	\$ 57.98

### KV DESK TOP FASTENERS

Wrought Steel



Code	Description	Ctn	List/ea
1547	12 Gauge	100/bx	\$ .65
1548	18 Gauge	500/bx	.52

### KV STEEL TABLE TOP FASTENERS

Nickel finish.  
 Pack: 100 ea/ctn.



Code	Description	List
320	1" Wide, 11 Gauge Steel	\$ 1.00
323	5/8" Wide, 14 Gauge Steel	.61
324	3/4" Wide, 14 Gauge Steel	.69

### T-NUTS



TNUT-14-20  
 1/4-20 thread

T38-16  
 3/8-16 thread



4-Prong Type

These one-piece threaded fasteners provide steel threads in wood for fast and secure assembly of components. Stamped from heavy gauge steel. Precision threaded and designed with a bevelled barrel for easier insertion. Special curved twist-type prongs bite tightly into wood. Zinc plated.

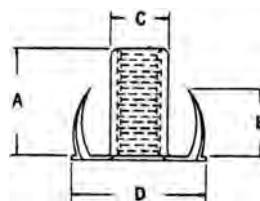

	A	B	C	D
T38-16	7/16	5/16	7/16	1
TNUT-14	13/32	1/4	5/16	11/16

### 4 Prong:

Code	Thread Size	List
T38-16	3/8-16	\$ 46.75 /C
TNUT-14-20	1/4-20	.35 /ea

## TOGGLERS

### TOGLER SCREW ANCHORS

from Mechanical Plastics

There are three features that all the Toggler Screw Anchors have in common:

- 1) They all use a 5/16" hole.
- 2) All the anchors will take a screw size from a #6 thru #14.
- 3) All the anchors will work in walls that are thicker than the size range on the box or package (so they can work in a semi-toggled position as a wedge anchor, or in solid material as an expansion anchor).



1. Fold anchor.



2. Insert anchor in 5/16" hole and tap flush with wall.

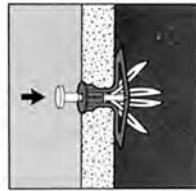

3. Insert setting key and pop anchor open (except in thick or solid walls)



TA



TB



TC

100 Toggles per box. Full Boxes only.

Code	Description	List/bx
TB100	Drywall, 3/8" - 1/2"	\$ 27.92
TC100	Plaster Wall, 5/8" - 3/4"	31.22

### TOGGLE BOLTS

from Mechanical Plastics



BA & BB:  
 3/16" - 1/4" Bolt



BC & BD:  
 3/8" - 1/2" Bolt

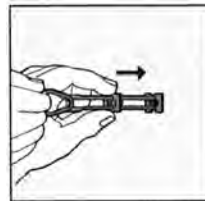

4. Slide plastic cap along straps with other hand until flange of cap is flush with wall.

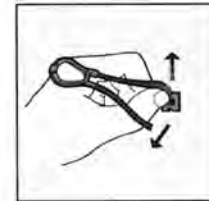

5. Place thumb between straps. Push side to side, snapping off straps level with flange of cap.

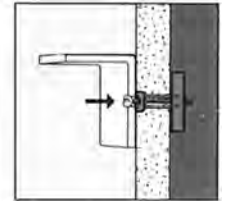

6. Place item over flange. Insert bolt and tighten until snug against item, then stop.

#### **Full Boxes only. Screws not included.**

BB100 takes PHMS 1/4-20 pan head machine screws (see below).

Code	Takes Bolt Size	Ctn	List/bx
BA100	3/16" -24	100	\$ 85.67
BB100	1/4" -20	100	95.02
BC25	3/8" -16	25	39.14

Pan head machine screws for above BB100 Toggles.

Code	Description	List/C
PHMS-2	1/4-20 x 2" Pan head	\$ 31.53
PHMS-3	1/4-20 x 3" Pan head	51.48

## TOGGLE BOLTS

### E-Z ANCHOR

Quickscrews



1. Place #2 Phillips screwdriver into recess of E-Z Anchor.



2. Press into wallboard while turning anchor clockwise until seated flush with the wall.



3. Place fixture in position, insert screw (#8 type A or AB screw is recommended).



4. Tighten fixture in place (a min of 1" engagement is recommended).

The E-Z Anchor is faster than any toggler. It pilots and sinks itself so you don't need a stud. No pre-drilling or hole preparation necessary. It is easily backed out. Uses standard #8 Tapping (sheet metal) screw.

Sold in Full Boxes Only.

Code	Description	Box	List/bx
1436QS	Zinc Anchor, #8	100	\$ 32.54

### HEAVY DUTY TOGGLER

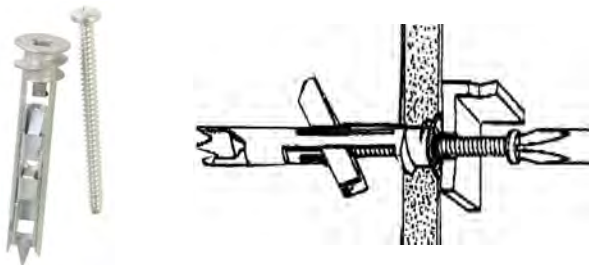

The EZ-Toggler is a self-drilling toggle bolt for heavy-duty anchoring to dry wall. With a 2-1/8" x #8 washer face phillips pan head sheet metal screw. 50 per box, sold in full boxes only.

Code	Description	Box	List/bx
EZ-TOG	Heavy Duty Toggle Bolt	50	

### TOGGLER SNAPSKRU™ from Mechanical Plastics

Self-Drilling Drywall Anchor

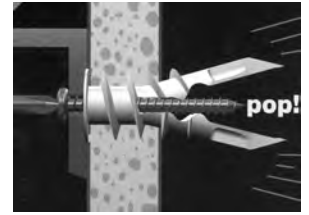

Drywall Thickness	Holds Up To
3/8"	57 lbs.
1/2"	79 lbs.
5/8"	135 lbs.

Holding values: Per anchor with #8 x 1-1/2" screws.  
 Industry standard safe holding = 1/4 of ultimate load.

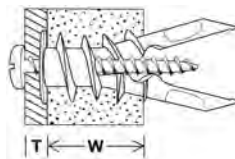

(T) Item thickness  
 Max. 3/4" (19mm)  
 with screw in box

(W) Wall thickness  
 Min. 3/8" (10mm)  
 Max. 5/8" (16mm)

For thicker items, use longer screw

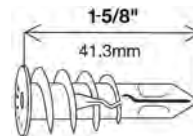

#6-#10  
 ø3.5 - 4.5mm  
 #8 preferred  
 S = Item thickness + 1-1/4" (32mm)

- Anchor locks on wall - hear it "pop" and lock
- Shock-resistant
- Vibration-resistant
- Installs with screwdriver or screw gun
- Positive stop resists overturning
- Can remove screw & item, leaving anchor in wall for reuse

Sold in Full Boxes only.

Code	Description	List/box
30012	50 Anchors with 50 #8 x 1-1/2 Combo Hd screws	\$ 18.71



## CLAMPS

### STEEL BAR CLAMPS, CLUTCH STYLE

- Powder coated, ductile cast iron jaws
- 2 piece slip clutch plates
- Nickel plated, drawn serrated rail
- Non-marring pads on the top and bottom jaws
- Ergonomically shaped wood handle



**Load Cap: 600 lbs.**  
**Replaces 3700 Series**

- 2-1/2" Throat Depth

Code	Max opening	Adj. Clamp #	List/ea
GSCC2.506	6"	3706	\$ 17.65
GSCC2.512	12"	3712	20.03
GSCC2.518	18"	3718	23.03
GSCC2.524	24"	3724	31.65
GSCC2.530	30"	3730	31.26
GSCC2.536	36"	3736	36.59

**Load Cap: 1200 lbs.**  
**Replaces 4500 Series**

- 5" Throat Depth



Code	Max opening	Adj. Clamp #	List/ea
GSCC5.012	12"	4512	\$ 56.53
GSCC5.018	18"	4518	68.62
GSCC5.024	24"	4524	76.15

### FACE FRAME CLAMP - For Installing Cabinets

Two Face frame stiles can be tightened, aligned, pre-drilled and fastened together while the clamp remains in place. Integrated pilot hole simplifies drilling. **Sold per each, but two is suggested per setup.**

- Holds individual cabinet frames together, plus faces, flush
- Aluminum alignment plate
- Integrated pilot hole
- Non-marring felt pads
- Replaces #8510-BP Adj. Clamp



Code	Description	Adj. Clamp #	List/ea
BES-8511	FF Cabinet Clamp	8510-BP	\$ 60.11

### 3/4" BLACK PIPE CLAMPS FIXTURE

- Replaces #50 Adj. Clamp
- Cast jaws for durability, smooth action spindle
- 3-1/2" Throat Depth



Code	Pipe Diameter	Adj. Clamp #	List/ea
PC34	3/4"	50	\$ 30.39

### SPRING CLAMPS

**Replaces 3200 Series**

- Vinyl tips and handles prevent marring
- Heavy duty springs for firm grip
- Nickel plating resists corrosion
- Handles shaped to fit the hand



Code	Description	Adj. Clamp #	List/ea
XM5	2" Spring Clamp	3202T	\$ 7.17
XM10	4" Spring Clamp	3204T	27.54

### MINI STEEL BAR CLAMPS - LIGHT DUTY

**Replaces 3700LD Series**

- Zinc die cast jaws are light weight
- Serrated rail for slip resistant grip
- Non-marring plastic caps on pressure pad



Code	Clamping Cap	Adj. Clamp #	List/ea
LM2.004	4"	3704LD	\$ 14.60
LM2.008	8"	3708LD	19.38

### ONE HANDED BAR CLAMPS

**Replaces 33000 Series**

- Clamping force up to 445 lbs
- Non-marring jaws
- No tools required for conversion to spreading



Code	Description	Adj. Clamp #	List/ea
EZS30-8	12" Bar Clamp	33412	\$ 41.95
EZS60-8	24" Bar Clamp	33424	50.59





## CLAMPS

### PECK CLAMP DOG

For frame and jig assemblies. Also where temporary clamping is required.



Code	Width	Ctn	List/ea
2CD	2"	12 ea.	\$ 11.21

### PECK MITER CLAMPS

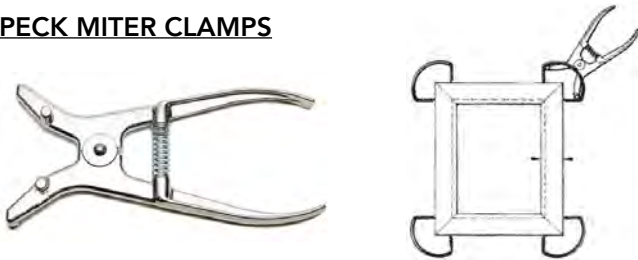

These high-quality miter clamps are made of chrome nickel steel. The points of the springs are designed for long life and to prevent excessive marks. Rings are stretched slightly with special pliers, then put into place and released. Pliers are then used with another spring on the next corner, released, and then on to the next corner.

Code	Description	List
CL-MTR-PL	Miter Clamp Pliers	\$ 117.57
R#1	Ring for 1/2" to 1-1/2" miters	8.32
R#2	Ring for 1/2" to 4" miters	8.62

## PUNCH KIT

### CUSTOM COLOR PUNCH TOOL AND KIT

Fastcap

Use with material up to .022" (.6mm). Not recommended for Plastic Laminate.

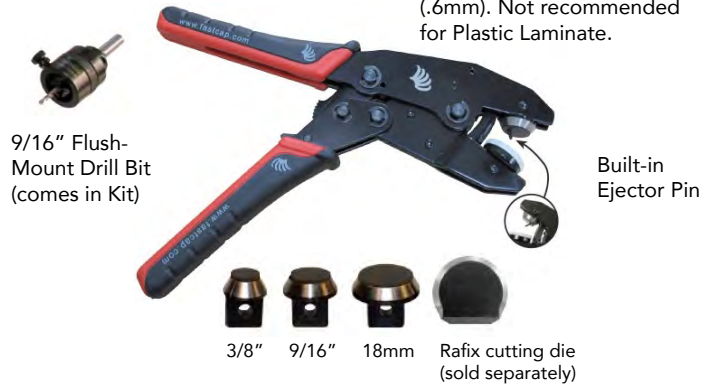

9/16" Flush-Mount Drill Bit (comes in Kit)

Built-in Ejector Pin

3/8" 9/16" 18mm Rafix cutting die (sold separately)

Need one cap and not 1,000? The Custom Color Punch Tool/Kit is for you. Take any standard edgebanding or veneer, apply SpeedTape, and punch your cap out.

#### Features

- Precision steel dies
- Ratcheting cutters
- Built in Ejector Pin

#### Great for

- Making custom caps
- Covering screws
- Covering mistakes



Custom Color Punch Tool includes:

- Hole Punch Tool
- 1" x 50' SpeedTape
- 3/8", 9/16" and 18mm die
- PowerHead screws
- Hard shell case



Custom Color Punch Kit includes:

- Hole Punch Tool
- 1" x 50' SpeedTape
- 3/8", 9/16" and 18mm die
- PowerHead screws
- Hard shell case
- AND FlushMount Drill Bit System



Custom colors with no match?



Get the perfect match with this kit!



1. Apply SpeedTape to edgebanding

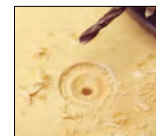

2. Drill hole



3. Countersink PowerHead screw



4. Apply Fastcap

Code	Description	List/ea
HOLE PUNCH KIT	Cust Color Punch Kit	\$ 210.92
HOLE PUNCH SINGLE	Cust Color Punch Tool	125.18



## SLIDE PRO

## 3RD HAND

### SLIDE PRO

Drawer Slide Installation Tool



Face Frame



Frameless

The Slide Pro is a fast, hands free installation system for any drawer slide. Install a whole set of slides at once, instead of one at a time! Use the adjustment shelves to align with the cabinet railings, then tighten the tension knobs to hold in place, and install the drawer slides to the perfect height every time. Its durability and accurate measurements make it great in the shop and out on the job for any cabinet drawer installations.

### Features

- Measuring tower for quick install
- Adjustable shelf system
- Tension Knobs

### Great For

- Framed and modular cabinets
- Retro fitting old cabinets
- Undermount drawer slides



Pack includes: (2) Measuring Towers, (6) Shelves w/ tension knobs, and (2) stands.

Code	Description	List/Pk
SLIDE-PRO	Slide Installation Tool	\$ 119.79

### 3RD HAND SUPPORT SYSTEM

Fastcap

The 3rd Hand, Upper Hand and Little Hand provide support, brace or clamp for whenever you might need an extra hand.

Uses:

- Cabinet installation
- Crown molding at angles
- Countertop backsplashes
- Installing window coverings
- Plastic Barriers
- Hanging dry wall
- Supporting ceiling paneling, lighting

**150 lb.  
Load Cap.**

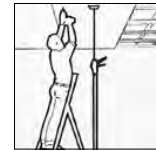

Pole extends 16.5" - 22.8"



3-H-LITTLE



3-HAND-5HD

Code	Description	Range	List
3-HAND-5HD	Third Hand	5' to 12'	\$ 89.87
3-H-UPPER-SINGLE	Upper Hand	28" to 60"	85.90
3-H-LITTLE	Little Hand	16.5" to 22.8"	72.03

Load Capacity: 150 lbs. (applies to each unit)



## FILES

### SAVE-EDGE FILES

Sharp, Long Lasting Files



Handy File, Dual-Cut File - 10"



Mill Coarse File - 10", 12"

The teeth on these files have been specifically designed for use on laminate and wood materials. Specially processed in the U.S. to create a uniquely sharp and long-lasting edge. One edge is smooth and one edge has teeth.

The **HANDYFILE** is a unique file with a single cut on one side and a double cut on the other side. Round handle. Excellent for use on all laminates and wood.

The **DUAL-CUT** is specifically for laminates. Mill Coarse cut on one side. Flat Coarse cut on the other side. Round handle. Flat Coarse side allows for rapid stock removal with a medium smooth finish.

The **MILL COARSE** is a single cut file (teeth cut one direction) and primarily used on laminate and wood. This file gives a smooth finish, yet removes material very well.

Code	Description	Ctn	List/ea
7308838FC	10" Handy File	12 ea.	\$ 23.58
PPC10DX	10" Dual Cut	12	35.00
7080306FC	10" Mill Coarse	12	17.16
7080308FC	12" Mill Coarse	12	20.93

### SIMONDS ALL PURPOSE FILES



8", 10"

All purpose files mill smooth cut on one side, bastard fast cut on the other side - both edges have teeth. Terrific for on-the-job touch-ups or when frequent alternating between fine and coarse filing is necessary. Just flip to the other side! The spatula-shaped integral handle makes them safe and easy to use. Top quality industrial files. Made in the USA.

Code	Size	Ctn	List/ea
SM8AP	8"	1 ea.	\$ 22.09
SM10AP	10"	1	24.27

### PLASTI-CUT FILES

Practical Products

Mill Cut



Fast Cut



Specially milled files for use on plastic laminate. Select the **MILL** cut for fast cutting and the smoothest finish. Select the **FAST** cut for fastest cutting and a smooth finish. Both edges have teeth.

Code	Description	Ctn	List/ea
PPC8M	8" Mill	10 ea.	\$ 15.90
PPC10F	10" Fast	10	30.10
PPC10M	10" Mill	10	22.10
PPC12F	12" Fast	5	40.81
PPC12M	12" Mill	5	29.50
PPC14M	14" Mill	5	37.69

### File Cross Reference Chart

Description	Save Edge	Plasti-Cut	Mercer
10" Mill Std.	6070010VA	PPC10M*	BFMB10
12" Mill Std.	6070012VA	PPC12M*	BFMB12
14" Mill Std.	6070014VA	PPC14M*	BFMB14
10" Mill Coarse	7080306FC*		
12" Mill Coarse	7080308FC*		
10" Flat Coarse	7010035FC	PPC10F*	BPLI10
12" Flat Coarse	7010038FC	PPC12F*	BPLI12
8" Dual Cut	7308840FC		BDUA08
10" Dual Cut	7308845FC	PC10DX	BDUA10
8" Handy File	7308833FC		
10" Handy File	7308838FC*		

\* Items we stock

**KNIVES**

**STANLEY UTILITY KNIFE**  
 with Retractable Blade



Front loading with 3 position retractable blade. Blade storage magazine in rear. String cutting feature in body - blade does not have to be exposed. Furnished with 3 each 11-921 heavy duty blades. Die-cast aluminum handle is durable and lightweight. 6 each per ctn.

Code	Description	List/ea
10-499	6" Length Utility Knife	\$ 11.57

**STANLEY REPLACEMENT UTILITY KNIFE BLADES**

Pointed, razor sharp utility knife blades. 5 per card, 10 cards per box.



Code	Size	List/cd
11-921	2-7/16" x .025"	\$ 2.79

**STANLEY BLADE DISPENSER**

Contains 100 utility knife blades. Wall display dispenses one at a time for safety and convenience. Holds 11-921 blades.



Code	Description	List/ea
11-921A	Blade Dispenser	\$ 30.92

**STANLEY SINGLE EDGE RAZOR BLADES**

Backed high carbon steel blades fit all standard razor blade tools. Bulk pack - 100 razors per box.



Code	Description	List/bx
11-515	Bulk, 100 per box	\$ 12.17

**PLIERS**

**FASTCAP END NIPPERS**

Has a flush 1" wide head that can be used for cutting up to 3mm edgebanding and a variety of other applications.



- Jaws ground flush
- Very versatile
- Small and compact
- Use on soft metals and wood

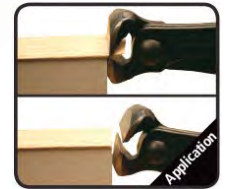

Code	Description	List/ea
PLIERS-ENDNIP	End Nippers	\$ 25.30

**FASTCAP HEAVY DUTY FLUSH CUT TRIMMER**

- Heavy Duty Cutters
- Cuts small nails and brads flush with surface
- Includes 2 PowerMags to help catch metal debris
- Not for hardened screws/fasteners



Code	Description	List/ea
PLIERS-HEAVYDUTY	Heavy Duty Flush Trimmer w/ Magnets	\$ 33.72

**STANLEY PROFESSIONAL BEVELS**

Hardwood handle with handy grip, brass tip, and locking device.



Blade Length: 8".  
 Handle Length: 5-1/2". 6 per box.

Code	Description	List/ea
46-825	Solid Hardwood T-Bevel	\$ 16.93

**STANLEY DIAGONAL CUTTING PLIERS**

Tempered steel, designed to provide maximum leverage and maintain sharpness. Rust resistant, foam covered handles. 6 pliers per box.



Code	Description	List/cd
84-105	6" Length Pliers	\$ 14.64



## TAPE MEASURERS

### STANLEY POWERLOCK TAPE

With Power Return



**POWERLOCK RULE:** Mylar™ coated yellow blade. Features heavy duty Tru-Zero hook and slide lock up front for easy operation. Graduated in 16ths of an inch. Shows 32nds on first twelve inches. Secure blade lock won't creep during measurements. With belt clip.

#### 3/4" Wide Yellow Blade

Code	Size	Ctn	List/ea
33-312	12'	6/box	\$ 25.37
33-116	16'	4/box	21.00

Same as above but with Metric as well as inch.



33-158	5m / 16'	6/box	\$ 28.96
--------	----------	-------	----------

#### 1" Wide Yellow Blade

Large and easy to read numerals and stud markings every 16 inches. Blade remains rigid up to 7'. Shown in inches.



Code	Size	Ctn	List/ea
33-425	25'	4/box	\$ 34.53

### STANDARD PEEL & STICK 16' TAPE

Fastcap

Puts a tape rule right where you need it. The flat 16' long tape measure is printed on both sides allowing for left or right read. Simply adhere the included SpeedTape to one side of the tape and stick it on!



PS-STICK-16

Code	Ctn	List/ea
PS-STICK-16	1	\$ 23.66

### PROCARPENTER "OLD STANDBY" TAPE MEASURE

Fastcap



PS-16 (16')

PS-25 (25')

Professional tape measure with 1 inch increments.

Features: Erasable notepad, high contrast black on white scale, heavy duty 1" blade, belt clip, pencil sharpener, dual thumb and finger locks and compact, shock-resistant rubber casing.

Code	Size	Ctn	List/ea
PS-16	16'	1	\$ 13.39
PS-25	25'	1	19.66

### PMS TAPE MEASURER

Fastcap

- Erasable note pad
- Standard English rule & Metric rule
- Heavy duty rubber boot
- Common conversion charts
- Scratch resistant coating



- Easy thumb lock
- Easy read fractions to 1/16"

Code	Description	List/ea
PMS16	16'/5m Tape	\$ 13.39
PMS25	25'/8m Tape	20.64

### PSSR TAPE MEASURER

Fastcap



Standard measurements that are readable when tape is extended from either right hand or left hand.

Features: Erasable notepad, pencil sharpener, Standard English rule, Easy read fractions to 1/16", Scratch resistant coating on tape, easy thumb lock, and heavy duty protective rubber boot. 12 each/ctn.

Code	Description	List/ea
PSSR-16	16' Tape	\$ 14.06



## SCREWDRIVERS

## SQUARES

### TAPE MEASURE HOLDER W/ BELT CLIP Fastcap

Never have torn pants from your tape measure again. Now securing your tape measure is a breeze. Holder easily clips over your pants or belt or screws to a workbench. It can even hold and sharpen a pencil! Also great for clipping on buckets and ladders.



<u>Code</u>	<u>Description</u>	<u>List/ea</u>
SPEEDCLIP	Tape Measure Holder	\$ 4.82

### POZI DRIVE SCREWDRIVERS

#2 Pozidrive for Hinges



Salice Screwdriver  
D2A7XCXCP



Screwdriver  
12360

<u>Code</u>	<u>Description</u>	<u>List/ea</u>
D2A7XCXCP	Salice Pozidrive Screwdriver	\$ 14.12
12360	Pozidrive Screwdriver	10.26

### 6 IN 1 SCREWDRIVER

Includes:  
Phillips #1,  
Phillips #2,  
Slotted 4.5 and 6mm,  
1/4" Hex, 5/16" Hex



12361

<u>Code</u>	<u>Description</u>	<u>List/ea</u>
12361	6 in 1 Screwdriver	\$ 13.55

### 4MM HEX SCREWDRIVER

Screwdriver with a 4mm Hex Tip. Ergonomic handle helps adjust Hettich Actro 5D undermount slides.



<u>Code</u>	<u>Description</u>	<u>List/ea</u>
306SD	4mm Hex Screwdriver	\$ 10.00

### FLAT SQUARE

Stanley

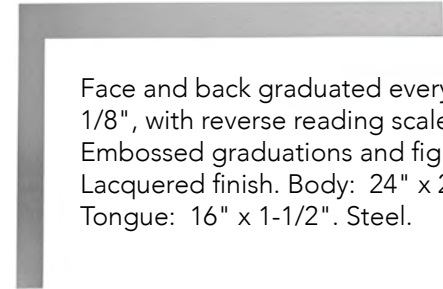

Face and back graduated every 1/8", with reverse reading scale. Embossed graduations and figures. Lacquered finish. Body: 24" x 2" Tongue: 16" x 1-1/2". Steel.

<u>Code</u>	<u>Ctn</u>	<u>List/ea</u>
45-500	6	\$ 9.90

### COMBINATION SQUARE

Stanley



Removable grooved blade graduated 8ths, 16ths, and 32nds. Scratch awl and versatile level vial built into handle. Level vial feature offers greater visibility. O.A. Length: 12", Handle: 4-1/4".

<u>Code</u>	<u>Ctn</u>	<u>List/ea</u>
46-123	1	\$ 27.71

### COMBINATION SQUARE/GROOVED BLADE

Stanley



Grooved blade, scratch awl and level vial included. Handle: 4-1/8", Overall Length: 12". Carded.

<u>Code</u>	<u>Ctn</u>	<u>List/ea</u>
46-222	6	\$ 17.75



## TOOLS

### SCRIBING TOOL

Fastcap

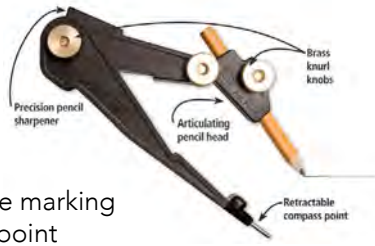

- Flat bottom for precise marking
- Retractable compass point
- Built-in pencil sharpener

The AccuScribe Pro makes it easy to maintain a consistent scribe offset, staying parallel to the object surface every time. Ideal for flooring, countertops, scribing trim on cabinets and more.

Code	Description	List/ea
ACCUSCRIBE-PRO	Scribing tool	\$ 29.02

### COMBINATION ARKANSAS STONE

Begin sharpening on the medium side and finish the edge on the hard, fine side. Cedar box.



Code	Size	List/ea
340-1500	6" x 2" x 1/2"	\$ 51.69

### COMBINATION FILE CARD AND BRUSH



CB-88B

Heavy duty file card with wire bristles to remove stubborn metal-clogging of file teeth. For best results, pull the card across the file in the direction of the file grooves.

19 Contains a plastic bristled brush on the other side which removes most of the filings. Wire side not recommended for PLASTI-CUT files. Wooden handle. 10" in Length.

Code	Length	Ctn	List/ea
CB-88B	10"	10	\$ 20.18

### STANLEY PRY BAR



Forged tool steel for extra toughness, with polished and beveled cutting edges. Contoured bar - ideal for pulling nails, prying, lifting or scraping. Beveled nail slot on both ends. Blade Width: 1-3/8". O.A. Length: 12-1/2".

Code	Ctn	List/ea
55-515	4	\$ 14.91

### STANLEY NAIL SETS



Square head, round knurled body. Alloy steel hardened and tempered. Tips are cupped and chamfered. Square head prevents rolling. Black phosphate finish. 11/32" square. Overall Length: 4". 1 per card, 6 cards/box.

Code	Tip	List/cd
58-111	1/32"	\$ 3.66
58-112	1/16"	3.58
58-113	3/32"	2.96

### HOLLOW SCREW EXTRACTORS

Turned counter-clockwise in an electric drill, this tool makes easy work of removing broken screws from wood, while leaving a clean hole that can be filled with a dowel or a plug.



Use the 1/4" model for screws up to #8 and the 3/8" model for the #10 screws and larger. Size refers to the finished hole size.

Code	Size	List/ea
800-3004	1/4"	\$ 24.62
800-3005	3/8"	26.52



## PLANES

### STANLEY 21° BLOCK PLANE



The cutter rests on its seat at an angle of 21° and is fully adjustable. For thickness of shaving, rotate knurled nut. Lever adjusts evenness of shaving. Mouth is also adjustable for coarse or fine work. Overall: 6" long. Cutter width: 1-5/8".

Code	Ctn	List/ea
12-920	1	\$ 70.38

### STANLEY 12° BLOCK PLANE



Fully adjustable, low angle. The cutter rests at an angle of 12°. This angle makes it easy to plane across a hardwood. The mouth is adjustable for coarse or fine work. Finger grips in sides. Cutter adjusted with knurled screw. Overall: 6" long. Cutter Width: 1-3/8".

Code	Ctn	List/ea
12-960	1	\$ 65.50

### STANLEY RABBET PLANE



For regular and bull nose work. This plane has two seats for the cutter: one for regular work and the other for bull nose work. It is fitted with a spur, a removable depth gauge, and adjustable fence. When used in the rear seat, the cutter is adjustable. Overall: 8-1/4" long. Cutter Width: 1-1/2".

Code	Ctn	List/ea
12-978	1	\$ 99.53

### STANLEY SOFT FACED HAMMER



High visibility Neon Orange

"Dead Blow"  
Construction

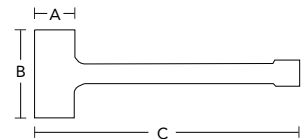

Non-sparking soft face hammers of UNICAST construction have no exposed metal. The soft face yields, will not mar surfaces or equipment & doesn't absorb liquids.

Code	A	B	C	Ctn	List/ea
57-532	2"	4-1/4"	12-3/4"	2	\$ 52.70
57-533	2-1/2"	4-3/4"	14"	4	67.64

### STANLEY SMOOTHING PLANE



These Stanley Bailey™ planes are excellent for general smoothing and fine finishing of high quality work. Cast iron bottom and sides are ground perfectly flat and true. Micro-adjustable mouth opening. Precision ground cutter.

Code	Length	Blade Width	List/ea
12-904	9-3/4"	2-1/2"	\$ 90.79

### STANLEY RUBBER MALLET



Tough rubber head molded to a lacquered handle. 18 oz. Overall Length: 13-3/4". 5 per box.

Code	Ctn	List/ea
57-522	5	\$ 21.13





## SCRAPERS

### STANLEY PUTTY KNIFE

1-1/4" wide blade.  
Nylon handle. Steel blade permanently fastened to shatter-proof handle.



Available with either stiff or flexible blades.  
Carded, 5 cards/box.

<u>Code</u>	<u>Blade</u>	<u>Blade Width</u>	<u>List/ea</u>
28-140	Stiff	1-1/4"	\$ 8.15
28-240	Flexible	1-1/4"	9.05
28-242	Flexible	2"	10.26

### CABINET SCRAPERS



The finest German steel. Ideal tool for refinishers. Regular rectangle, curved on opposite ends, and classic "gooseneck" shape. Use a burnisher to sharpen.

<u>Code</u>	<u>Description</u>	<u>List/ea</u>
520-5010	Rectangle, 0.8mm	\$ 9.38
520-5510	Set of 3, one of each shape	36.11

### STANLEY SCRAPER REPLACEMENT BLADE

This 2-edge scraper replacement blade is made of high carbon steel. Fits scraper 28-619.



<u>Code</u>	<u>Blade Width</u>	<u>Ctn</u>	<u>List/ea</u>
28-292	2-1/2"	5 ea.	\$ 3.86

## CHISELS

### STANLEY BEVEL EDGE CHISEL



Tough handle design for balance and grip. Crown shaped steel cap centers hammer blows. Blade and tang are forged from one piece of high quality cutlery grade steel. Blade 3" long. Carded, 2/box.

<u>Code</u>	<u>Width</u>	<u>OA Length</u>	<u>List/cd</u>
16-907	3/4"	9"	\$ 16.86
16-908	1"	9"	19.23

### STANLEY WOOD CHISEL SETS

Set of 6 chisels. Durable storage case sits on work area for easy selection.



1 set/box.

<u>Code</u>	<u>Sizes</u>	<u>List/st</u>
16-901	1/4", 1/2", 3/4", 1" 1-1/4", 1-1/2"	\$ 102.44

**APRONS**

**KNEE PADS**

**14 POCKET, DOUBLE TIER, PROFESSIONAL BIB-STYLE APRON**  
 McGuire-Nicholas

Overall Size: 23-1/2" x 9-1/2".  
 100% natural cotton canvas. Five lower and 7 upper pockets, 2 bib pockets for easy pencil and pad access. Polypropylene hammer loop on right and left sides, rivet reinforced. 6 ea/box.



Code	Description	List/ea
C7	Bib-Apron	\$ 16.55

**LONG 3 POCKET APRON**  
 McGuire-Nicholas

Economy apron. OA length: 40".  
 100% blue cotton canvas. 1 large waist pocket, 2 small pencil & pad bib pockets. Extra reinforcements at stress points. Canvas loop neck and waist ties. Polybagged.



Code	Ctn	List/ea
30	3 ea.	\$ 13.65

**FIVE POCKET WASTE APRON**  
 McGuire-Nicholas



C14

100% natural cotton canvas. Has two large flared pockets, three small pockets, two webbed hammer loops and long waist ties.

Code	Ctn	List/ea
C14*	3 ea.	\$ 10.51

\*disc when out

**KNEE PADS**

Alta Industries

Hook & Loop closures - infinitely adjustable for quick on/off convenience. Nylon thread is fully stitched throughout for optimum strength and durability. Uses 1-1/2" contoured foam rubber cushioning for maximum comfort and tough Cordura nylon which resists water, abrasion and deterioration.

**507:**

- Contoured mar-resistant capless design
- Navy Cordura® Nylon Cover
- AltaGrip™ Hook & Loop Fastening System



**509AL:**

- Hard White plastic cap for easy swiveling and maneuvering on work surfaces
- Navy Cordura® Nylon Cover
- AltaGrip™ Hook & Loop Fastening System



**504S:**

- Long, durable thick rubber Black Cap provides traction, resists skidding and protects against rocks and debris
- Black Cordura® Nylon Cover
- AltaGrip™ Hook & Loop Fastening System



Code	Description	List/pr
507	Strap-on Cordura Nylon Knee Pads, No Cap	\$ 28.07
509AL	Same as 507 except has polypropylene cap for greater comfort, support & protection	31.55
504S	Knee pads w/ long rubber cap	40.54



## JIGS



### DRILL GUIDE SET FOR KNOBS/PULLS

Built for speed, the TP-1934 Cabinet Hardware Jig installs knobs and handles on doors and drawers. Saves tedious hours of measuring, clamping or making jigs.

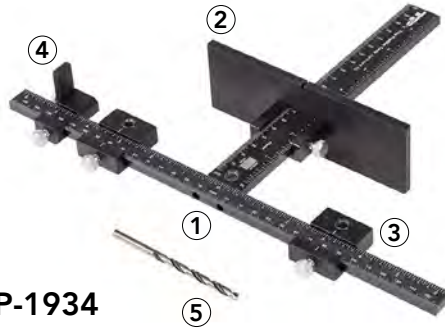

TP-1934

- For knobs or pulls up to 12" C/C
- Case hardened steel bushings
- Reversible for LH or RH doors
- Versatile - measures for Euro hinge plates and shelf pin holes, too

Code	List/ea
TP-1934	\$ 385.68

#### Includes:

- 1) 12" T-Square w/ Center Bushing
- 2) Large Stop
- 3) 2x Sliding Drill Guides
- 4) Sliding End Stop
- 5) 5mm Drill Bit
- 6) Hard Plastic Carrying Case



### Extension Set - TP-2312-NC

Extension Set for TP-1934 Jig. Allows up to 38" C/C (960mm) handles and stop for drawer fronts up to 42". Doubles as a portable 32mm shelf pin jig. Reversible.

#### Includes:

- 1) TP-ERA 17-1/2" Extended Ruler
- 2) Double Bracket
- 3) 2x line bore Extension Bars for up to 36" of 32mm line drilling
- 4) 5mm Drill Bit w/ stop collar



### Extended Ruler Attachment - TP-ERA



Eliminates the need to center your cabinet hardware jig on every drawer front. Allows up to 38" C/C (960mm) handles and stop for drawer fronts up to 42".

#### Includes:

- 17-1/2" ruler w/ 2 sided print, bracket for T-square connection and 2 extra thumbscrews.



Code	List/ea
TP-2312-NC	\$ 265

Code	List/ea
TP-ERA	\$ 100



# JIGS

## EURO HANDLE-IT

18" Jig for Handle and Knob Drilling

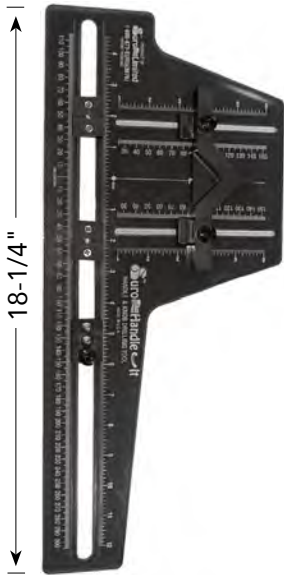

- Installs handles as large as 24" (600mm)
- Height adjustment to center of a 12" high drawer front.
- Center reference line for extra wide drawer fronts.
- Moveable positioning stops for use on drawer fronts of the same size.
- English and metric scales for use on all handles.
- V-Notch in fence for use in installing handles at a 45° angle.
- Made of Polycarbonate (jet aircraft canopy material).

**EHIT**  
Installation  
Tool



Code	Ctn	List/ea
EHIT	Jig for Handle and Knob Drilling	\$ 90.57
EHIT-BUSHINGS	Heat Treated Bushings Kit with screws and nuts	23.40

## KREG POCKET HOLE JIG 720

Makes strong and fast Face Frame joints with only a hand drill!



- Advanced jig for creating pocket-hole joints more efficiently in materials from 1/2" to 1-1/2" thick
- One-motion clamping automatically clamps and adjusts to the proper material thickness
- Anti-slip holds material in place for worry-free clamping
- Chip ejection port helps eliminate wood dust mess and connects to a shop vacuum
- Durable, impact-resistant construction with steel reinforced spine and lifetime drill guide warranty

Includes 60 Kreg pocket-hole screws and a free project plan so you can start building right away.



## KREG JIG ACCESSORIES

### Replacement Drill Bit

3/8" dia, Right hand, w/ Hex Shank

KA BIT



### Stop Collar

Includes material-thickness gauge/wrench

KJSC



### Face Clamp

3" Reach

FC



### Jig Clamp

Secure Jig to your workstation

KPHA760



### Stepped Drill Bit

Heavy-duty, cobalt-steel

DKDB



Code	Description	List/ea
KPHJ720	Kreg 720 Pocket Hole Jig	\$ 215.00
KPHA760	Clamp for 520/720 Jig	24.98
KA BIT	Hex Shank replacement bit	36.67
FC	Face Clamp	44.25
KJSC	Stop Collar	8.27
DKDB	Stepped Drill Bit	64.83



## JIGS

### KREG CONCEALED HINGE JIG W/ BIT

Kreg Concealed Hinge Jig. Make cabinet door installation easy! Get drill press accuracy with any hand drill.



- For installing 35mm cup-style concealed hinges
- Works with any hand drill and with 3mm, 4mm, 5mm, 6mm hinge offsets
- Four-cutter carbide-tipped bit with stop collar
- Accurate hinge positioning with built-in indexing tabs
- Repeatable results with built-in measuring scales
- Adjustable cams ensure proper hinge offset
- Durable carbide-tipped drill bit included
- Strong, lightweight materials for easy handling

<u>Code</u>	<u>Ctn</u>	<u>List/ea</u>
KHI-HINGE	Concealed Hinge Jig w/ bit	\$ 41.37

## LAMINATE TOOLS

### VIRUTEX EDGE TRIMMER

This tool simultaneously trims both edges of vinyl or other press-on edging. For panels 9/16" to 1-3/4" thick.



<u>Code</u>	<u>Description</u>	<u>Ctn</u>	<u>List</u>
ET93	Edge Trimmer	1 ea	\$ 42.27/ea
ET94RP	Replacement Blades (6 ea. per card)	1 set	25.16/cd

### VIRUTEX LAMINATE CUTTER

Strip cutter for laminates, quick and easy to use. With it, you obtain a clean splinter free cut with no waste. Also used for the edgbanding process.



Special system of cutting made of two wheels that make a very clean cut, with no waste and with a guide to keep the strip straight. Planing width: 12-110 mm, Cutting depth: 0-2 mm, Weight: 2.65 lbs.

<u>Code</u>	<u>Description</u>	<u>List/ea</u>
C015L	Laminate & Veneer Cutter	\$ 315

### J ROLLER

Gundlach



Has strong aluminum alloy handle with lightweight comfortable grip. Rubber roller: 1-1/2" dia, 3" wide. Overall Length: 12-1/2". Pack: 1 per box.

Code: J200B      List \$ 27.61

### EXTENDABLE LAMINATE ROLLER

Gundlach



Features 17" to 27" extendable handle and three separate rollers with a total of 7-1/2" width. Rollers are made of long-life non-marking material. Firm grip handle. Uses: wallcoverings, plastic laminates, vinyl floorcovering.

Code: 333-AR      List \$ 27.61



## SAWBLADES

### CLASSIC RULES OF THUMB FOR CHOOSING A CIRCULAR SAWBLADE

- 1) The thinner the material, the more teeth are needed. The thicker the material, the fewer teeth are needed.
- 2) Three teeth need to be in the material at all times:  
1 coming out, 1 in the middle of the material, and 1 coming in.
- 3) For solid wood material use ATB (alternate top bevel) teeth.
- 4) For particle board, MDF, and other abrasive man-made materials use TC (triple chip or trapezoidal) teeth.
- 5) For table saws use positive rake (teeth leaning forward), except for melamine, Corian and aluminum, which need negative rake blades.
- 6) For radial arm saws always use negative rake (teeth leaning backwards), because it reduces pulling of the material.
- 7) Blades should protrude about 1 tooth length out of the material.



LEITZ SAWBLADES from GERMANY offer high-tech engineering. Blades have fine-grain industrial carbide tips. Pre-tensioned steel plates keep the blade running steady and true. Copper plugs in the body of the blade help reduce vibration. State-of-the-art Leitz design features add up to superior cuts and a longer-life sawblade!

### LEITZ RIP SAWBLADE



Rip sawblade with chip limiters. Dia: 10" with 5/8" bore. Kerf: 1/8"

Code	Teeth	Grind	List/ea
831R-ATB	24T	ATP pos.	\$ 172.04

### LEITZ RIP & CROSSCUT SAWBLADE

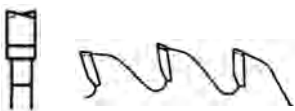

Rip and Crosscut Sawblade.  
Dia: 10" with 5/8" bore. Kerf: 1/8"

Code	Teeth	Grind	List/ea
790R-ATB	40T	ATB pos.	\$ 199.94

### LEITZ SAWBLADE

For Cross-Cut and Man-Made Material

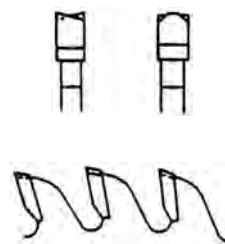

Dia: 10" with 5/8" Bore. Kerf: 1/8"

#### For Cross-Cut:

Code	Teeth	Grind	List/ea
792R-ATB	60T	ATB pos.	\$ 158.18

#### For Man-Made Material:

792R-TCG	60T	TC pos.	\$ 216.91
----------	-----	---------	-----------



## SAWBLADES



### LEITZ FINE CUT SAWBLADE

Dia: 10" with 5/8" Bore. Kerf: 1/8"



#### For Fine Cross-Cut:

Code	Teeth	Grind	List/ea
791R-ATB	80T	ATB pos.	\$ 210.82

#### Man-Made Material (Fine Cut or Thin Material):

791R-TCG	80T	TC pos.	\$ 181.65
----------	-----	---------	-----------

### LEITZ DOUBLE-SIDED LAMINATE BLADE



Sawblade for double-sided laminates, negative rake.  
Dia: 10" with 5/8" bore. Kerf: 1/8"

Code	Teeth	Grind	List/ea
843R-TCGN	60T	TC neg.	\$ 157.47

### LEITZ MELAMINE SAW BLADE

Long-wearing tooth pattern: adjustable height for chip-free cutting.



Sawblade for fine or thin cuts on double-sided laminates. Dia: 10" with 5/8" bore. Kerf: 1/8"

Code	Teeth	Grind	List/ea
844R-TCGN	80T	TC neg.	\$ 226.67

Triple chip design is said to stay sharp longer than ATB design in abrasive man-made panels; melamine, MDF, etc.

### LEITZ SAWBLADE FOR MITER OR RADIAL ARM SAWS

For Fine Cuts



Sawblade fits on miter or radial arm saws. For fine cuts. Dia: 10" with 5/8" bore. Kerf: 1/8"

Code	Teeth	Grind	List/ea
838R-ATBN	80T	ATB neg.	\$ 208.00

### LEITZ MELAMINE SAWBLADE



**Hi-ATB**  
Melamine Blade  
30° ATB  
Neg Rake Angle

This Hi-ATB Melamine Blade has a negative rake which makes it ideal for smooth, chip-free cuts in laminates. Adjust blade height to find best result. Dia: 10" with 5/8" bore. Kerf: 3.2mm

Code	Teeth	Grind	List/ea
838R-ATBN30	80T	ATBN 30°	\$ 237.28

## SAWBLADES



CMT blades are made in Italy. All blades include patented carrying case and baked-on PTFE non-stick orange coating.

### CMT CUT-OFF ATB SAWBLADES



All-around cut off blade for hardwood, softwood, plywood and chip board. Alternate top bevel teeth, micrograin carbide 5° hook angle. 60 tooth. For use on table and miter saws.

- Bore Dia: 5/8", Blade Dia.: 10"
- Kerf Thickness: .102
- Plate Thickness: .079

Code	Description	List/ea
205.060.10	10" Dia, 60T	\$ 95.12

### CMT PRECISION DADO SET

Set includes:

2 blades, 6 carbide tipped four tooth chippers and a set of 10 steel shims.

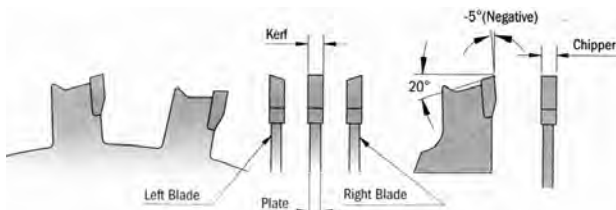

- Anti-kickback design
- Splinter resistant cuts in veneer plywood, melamine and hard and soft woods; chipper made especially for undersize plywood
- Six chipper blades. Four tooth design keep the cut flat and virtually free from tear out. Chipper sizes: 4 x 1/8", 1 x 3/32", 1 x 1/16"
- Shim sets included to set up any cut you want between 1/4" and 29/32"
- Micrograin carbide teeth
- Laser cut, high grade German steel blade body
- 5/8" Bore Dia.

Code	Description	List/ea
230.524.08	8" Dia, 24T	\$ 317.00

### CMT FINE CUT-OFF SAWBLADE

High ATB for Melamine



40° top bevel provides flawless finishing on melamine, hard and soft woods. Absolutely minimal chipping on double face material!

- 40° Bevel Angle, ATB
- Noise reducing laser cut channels
- Micrograin carbide teeth
- ATB grind, Hook Angle: 5°
- Kerf thickness: .126, Plate Thickness: .087

Code	Description	List/ea
210.080.10	10" Dia, 80T	\$ 131.72

### CMT COMPOUND MITER & RADIAL SAW

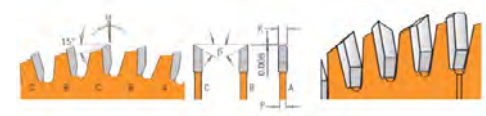

- The -5° hook angle, thin kerf, 30° bevel, and high tooth count allow smooth cuts in plywood, solid wood and laminates. Micrograin carbide tips.
- The negative hook angle keeps blade from climbing at aggressive feed rates
- Noise-reducing laser cut channels
- Grind: 4ATB+1FTG raker
- Hook Angle: -5°, Kerf: 0.114, Plate Thickness: .098

Code	Description	Bore	List/ea
219.060.08	8-1/2" Dia, 60T	5/8"	\$ 95.69
219.080.10	10" Dia, 80T	5/8"	133.00
219.090.12	12" Dia, 90T	1"	168.85



## SAWBLADES

### AMANA SAW BLADE

HG10480  
 Carbide Tipped  
 Hollow Ground  
 10" Dia x 48T HG,  
 -6 Deg, 5/8 Bore



This specially designed saw blade makes exceptionally smooth cuts in melamine and other coated boards, without the need for scoring.

The unique hollow grind, which pairs a triple-chip tooth with a raker tooth that's ground to a concave profile, produces crisp, clean cuts. The grind is commonly used in vertical panel saws, such as those made by Striebig® and Holz-Her®. The negative hook angle is particularly suitable for vertical panel saws.

Code	Description	Bore	List/ea
HG10480	10", 48T Hollow Ground	5/8"	\$ 220.98

### AMANA SAW BLADE

MD10-487-30  
 Carbide Tipped  
 Hollow Ground  
 10" Dia x 48T  
 HG, 10 Deg,  
 30mm Bore

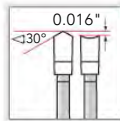
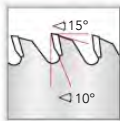

Amana Carbide Tipped Hollow Ground 10" Dia x 48T, HG, 10 Deg, 30mm Bore Circular Saw Blade. The unique hollow-ground design produces crisp, clean cuts in melamine and other coated boards without the need for scoring. These blades pair inverted "V" teeth along with raker teeth and positive hook. They are particularly suitable for use on vertical saws such as those made by Striebig®, Altendorf®, SCM®, and Holz-Her®.

Code	Description	Bore	List/ea
MD10-487-30	10", 48T Hollow Ground	30mm	\$ 127.58

### LEUCO SAWBLADES - Special Order



HG: Hollow ground  
 Pos: Positive Hook  
 Neg: Negative Hook



ATB -  
 Alternate  
 top bevel



TCG -  
 Triple chip  
 grind



HG -  
 Hollow  
 Grind

### Table Saw Blades

Code	Dia.	Bore	Teeth	Saw	Net/ea
188426	10"	5/8"	x 50T ATB Flat	Chip	
80231459	10"	5/8"	x 60T ATB	Table	
188435	10"	5/8"	x 60T TCG	Table	
188418	10"	5/8"	x 80T ATB	Table	
188436	10"	5/8"	x 80T TCG	Table	
188432	10"	5/8"	x 24T TCG	Rip	

### Melamine Saws

		Hook
181995	250mm x 30mm x 80T High-ATB	-2°
181996	300mm x 30mm x 96T High-ATB	2°

### Altendorf Sliders/Striebig Vertical Panel Saws

(use similar sizers)

188979	300mm x 30mm x 72T TCG	10°
188661	300mm x 30mm x 96T ATB	10°
188980	300mm x 30mm x 96T TCG	10°
169739	300mm x 30mm x 60T HG	-6°
		Neg. Hook
169738	300mm x 30mm x 60T HG	10°
		Pos. Hook

### Split Scoring Blades

169892	100mm x 22mm x 2x10 Alten, Martin, Strei
169883	120mm x 22mm x 2x12 Alten, Martin
188528	120mm x 20mm x 2x12 SCM
188398	120mm x 50mm x 2x12 Altendorf
	Rapido Split Scoring

### Holz Her

169737	220mm x 30mm x 42T HG Pos.
181716	220mm x 30mm x 64T TCG



## CNC TOOLING

### LEUCO: CNC TOOLING - Special Order

#### Spiral Router Bits - Solid Carbide



#### 2 Flute Down Cut Spiral Bits

Designed for solid woods, wood composites and some plastics. This bit is used where a downward chip removal is required. Provides downward pressure and leaves an excellent finish on the top.

Code	Cutting		Shank	Overall Length	Net
	Outside Dia.	Edge Length			
500009	1/4"	1"	1/4"	2-1/2"	
1721018	3/8"	1-1/4"	3/8"	3"	
1720573	1/2"	1-1/4"	1/2"	3-1/2"	
500021	1/2"	1-5/8"	1/2"	3-1/2"	

#### 2 Flute Up Cut Spiral Bits

Designed for solid woods, wood composites and some plastics. This bit is used where an upward chip removal is required. Provides upward pressure. Chip removal is optimized but adequate hold down is needed.

Code	Cutting		Shank	Overall Length	Net
	Outside Dia.	Edge Length			
500008	1/4"	1"	1/4"	2-1/2"	
1721019	3/8"	1-1/4"	3/8"	3"	
1720572	1/2"	1-1/4"	1/2"	3-1/2"	
500020	1/2"	1-5/8"	1/2"	3-1/2"	

#### 2 Flute Compression Spiral Bits (2 + 2)

Designed for double-sided laminated or veneered materials. This bit is used where an excellent finish for both top and bottom is required.

Code	Cutting		Shank	Overall Length	Net
	Outside Dia.	Edge Length			
1721351	1/4"	1"	1/4"	2-1/2"	
1731181	3/8"	1-1/4"	3/8"	3"	
1727268	1/2"	1-1/4"	1/2"	3"	
500059	1/2"	1-5/8"	1/2"	3-1/2"	
1720542	1/2"	2-1/8"	1/2"	4"	

## DRILL BITS

### CMT SPIRAL BITS - 2 Flute

Solid Carbide



191  
Upcut Spiral

Code	Shank	Cut Dia.	Cut Length	Ovall Length	List
191.008.11	1/4"	1/4"	1"	2-1/2"	\$ 26.18
191.505.11	1/2"	1/2"	1-1/4"	3"	82.36
191.507.11	1/2"	1/2"	2"	4"	102.36

### AMANA COMPRESSION BITS



CNC Solid Carbide  
Compression Spiral

CNC 2 flute compression bits. Special unique carbide for longer lifetime in abrasive material. Designed for CNC applications requiring high feed rates and a clean finish. Particularly suitable for double-sided melamine or laminated material.

Code	Shank	Cut Dia.	Cut Height	Ovall Length	List/ea
46188	1/2"	1/2"	1-1/4"	3"	\$ 116.72
46190	1/2"	1/2"	1-5/8"	3-1/2"	140.33
46367	3/8"	3/8"	7/8"	3"	117.02

Amana CNC Solid Carbide Spektra™ compression Spiral bit. Has a much shorter up-cut section than the standard compression tools. Ideal for mortising grooving and dado.



46367-K	3/8"	3/8"	7/8"	3"	\$ 125.77
---------	------	------	------	----	-----------

### METRIC BRAD POINT DRILLS



5mm or 10mm

Excellent quality High Speed Steel woodworking bit. Designed for standard 3-jaw chucks. Carded, 1 ea/cd.

Code	Dia.	Overall Length	List/cd
570-7050	5mm	90mm (3-1/2")	\$ 22.03
570-7100	10mm	130mm (5")	27.27

## DRILL BITS

### FULLER BRAD POINT DRILLS



High Speed Steel brad point drill for clean holes in wood, plastic and sheet metal.

Code	Dia.	Overall Length	List/ea
281-5MM	5mm	3-3/8"	\$ 13.44
281-6MM	6mm	3-21/32"	15.95
281-7MM	7mm	4-9/32"	20.95
251-316	3/16"	3-1/2"	11.07
251-14	1/4"	4"	15.12

### FULLER STANDARD TWIST DRILLS



High-quality, U.S. made, high speed steel twist drills; for drilling wood, plastic, and metal.

Code	Size	Flute Length	Overall Length	List/ea
151-116	1/16"	7/8"	1-7/8"	\$ 2.79
151-564	5/64"	1"	2"	2.82
151-332	3/32"	1-1/4"	2-1/4"	3.00
151-764	7/64"	1-1/2"	2-5/8"	2.80
151-18	1/8"	1-5/8"	2-3/4"	3.36
151-964	9/64"	1-3/4"	2-7/8"	3.21
151-532	5/32"	2"	3-1/8"	3.32
151-1164	11/64"	2-1/8"	3-1/4"	3.53
151-316	3/16"	2-5/16"	3-1/2"	5.56
151-732	7/32"	2-1/2"	3-3/4"	5.19
151-14	1/4"	2-3/4"	4"	5.18
151-516	5/16"	3-3/16"	4-1/2"	8.83
151-38	3/8"	3-5/8"	5"	12.48
151-12	1/2"	4-1/2"	6"	20.30
151-1564	15/64"	2-5/8"	3-7/8"	5.94

(For use with undermount drilling jigs (V6JIG))

### DRILL STOPS

For above drills



Code	Description	List/ea
106-5MM	Drill stop for 5mm brad pt	\$ 6.48
106-6MM	Drill stop for 6mm brad pt	6.54
106-1564	Drill stop for 151-1564	5.99

### BOSCH CARBIDE TIPPED BORING BITS

Industrial Carbide Tipped.  
 Shank Size: 10mm x 20mm.

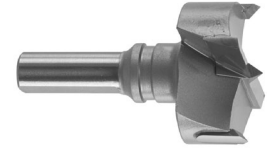

Overall Length: 57mm. With adjustable top screw.

Code	Hand	Dia.	List/ea
T15040	RH	40mm	\$ 50.16

### AMANA BRAD POINT BORING BIT

Positive ground spurs for rapid easy boring into hardwoods. Ideal for hinge boring machines and line boring machines that may have limited power, or bore mostly hardwood.

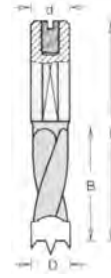

L = 57mm long,  
 (d) 10mm x  
 (B) 27mm shank

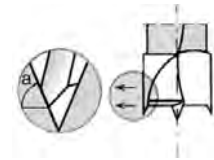

RH	LH	D	List/ea
201005	301005	5mm	\$ 19.75
201008	301008	8mm	27.60

### BOSCH TWIST HINGE BORING BIT



Shank: 10 x 26mm with adjustable top screw

Boring bits for multi-spindle machines. Use on most automatic & semi-automatic boring machines. Fits almost any European boring machines.

Max. Boring Depth: 36mm. Shank: 10 x 26mm.  
 Overall Length: 57mm. With adjustable top screw.  
 Positive grind for hardwoods.

Code	Hand	Dia.	List/ea
T15015	LH	5mm	\$ 19.51
T15018	LH	8mm	25.41
T15008	RH	8mm	25.42



## DRILL BITS

### CMT CARBIDE TIPPED BORING BITS

"Fatigue proof" Swiss steel body, micrograin carbide tips, bake-on non-stick coating and honed edges. Made in Italy. Negative ground spurs on boring bits give clean cuts in melamine without chipping.

### 2 FLUTE DOWEL DRILL

CMT



Size	RH	LH	Length	List
5mm	310.050.11	310.050.12	57.5mm	\$ 16.00
8mm	310.080.11	310.080.12	57.5mm	21.12
10mm	310.100.11	310.100.12	57.5mm	26.21
5mm	311.050.11	311.050.12	70mm	19.77
8mm	311.080.11	311.080.12	70mm	18.70

### 2 FLUTE DOWEL DRILL FOR THROUGH HOLES

CMT

Overall  
Length: 70mm



Size	RH	LH	List
5mm	314.050.11	314.050.12	\$ 27.08
7mm	314.070.11	314.070.12	28.54

### HINGE BORING BIT

CMT

Overall  
Length: 57.5mm



Size	RH	List
15mm	317.150.11	\$ 44.00
20mm	317.200.11	45.53
25mm	317.250.11	49.13
26mm	317.260.11	47.66
35mm	317.350.11	42.08
40mm	317.400.11	64.41

### CMT FORSTNER BIT WITH PARALLEL SHANK

Overall Length: 90mm,  
High Speed Steel.  
Right Hand.  
For drill press.



Size	RH	List
35mm	537.350.31	\$ 22.07

### FLUSHMOUNT DRILL BIT SYSTEM

Fastcap

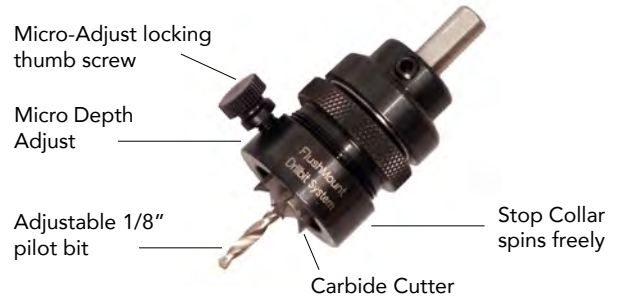

Incorporates a unique ball bearing stop collar that controls the recess depth of the drill and allows the stop collar to stop spinning when it comes in contact with the surface. Includes a 9/16" carbide cutter.

#### Features

- Includes a 9/16" carbide cutter
- Micro depth adjustment
- Adjustable 1/8" pilot bit

#### Great For

- Countersinking Fastcaps
- Countersink Powerhead screws
- Recessing magnets



Code	Description	List/ea
FC-DB-MICRO	Flushmount Drill Bit System w/ 9/16" cutter	\$ 82.99

### CMT FORMULA 2050 - BLADE AND BIT CLEANER

Environmentally friendly and safe. Non-toxic, non-flammable and certified biodegradeable, it penetrates the microscopic cracks in the resin. The resin releases its grip and you simply wipe it off.



18 oz.  
spray bottle

Keeps tools clean and increases their lifespan. Use on all woodworking cutting tools: i.e. sawblades, router bits, drill bits, shaper cutters, planer blades, etc.

Code	Description	Ctn	List/ea
998.001.01	18 oz. spray bottle	12 ea.	\$ 14.49



## COUNTERBORES

### FACE FRAME COUNTERBORE

Amana



Precision ground carbide-tipped counterbore for splinter-free cutting. Non-slip surface treatment for positive clamping. Wide web design for superior strength and replaceable HSS fishtail drills. Will fit Ritter faceframe machines.

Code	Dia	Shank	OA Length	List/ea
424000	3/8"	3/8"	4-1/2"	\$ 56.20

### REPLACEMENT BIT FOR COUNTERBORES



High speed steel replacement bit for above face frame counterbores. #29 fishtail point. 2-7/8" Overall Length. Sold per each.

Code	Dia	OA Length	List/ea
424004	.136	2-7/8"	\$ 11.48

### STEP DRILL FOR CONNECTING SCREWS

Quickscrews

Drills 3 different diameters in one operation: 5mm, 7mm, 10mm.

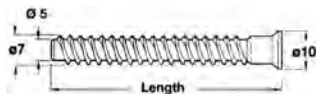

(connecting screw)



Overall Length: 5-3/4"

Code	Description	List/ea
12793P	High Speed Steel	\$ 97.16

### AMANA HEX SHANK DRILLS



RTA Furniture Drill/Countersink with Quick Release. 1/4 Hex Shank for 7mm Screw. Used for drilling pilot hole, clearance hole and countersinking. Cutting height 19mm.

Code	Dia	Shank	OA Length	List/ea
55292	5mm	1/4"	62mm	\$ 35.82

### FULLER HEX SHANK DRILLS

Taper Point



1/4" Hex Drive Shank

Hex shank fits Apex or Quickscrews bit holders. Change from screwdriver bits to drill bits and back with ease. High Speed Steel.

Code	Drill Dia.	Wood		Overall Length	List/ea
		Screw Size	Flute Length		
40125	1/8"	5	1-5/8"	3-1/2"	\$ 11.13
40140	9/64"	6	1-3/4"	3-5/8"	12.99
20140171	11/64"	8	2-1/8"	3-15/16"	15.11
40203	13/64"	10	2-7/16"	4-3/8"	16.25



## FULLER COUNTERSINKS

### FULLER TYPE "C" COUNTERSINKS

With 82° Angle

To cut woods and plastics for heads of wood screws. Drills, counter-sinks and counter-bores in one quick operation. Makes driving screws easier and assures the best possible holding power. Designed for clean cutting and hardened for long wear. Countersink on bottom-right shown mounted on a Taper Point Drill with a Stop Collar. The Countersinks can also be mounted on ordinary straight twist drills allowing the screw thread to cut its own hole or by using correct pilot drill size for root diameter of thread allowing shank of screw to force its way into the wood.

The countersink is held in place with two hex-socket screws and is easily adjustable up and down so **ONLY ONE COUNTERSINK AND ONE LENGTH OF DRILL IS REQUIRED FOR ANY LENGTH OF WOOD SCREW.**

Overall length of countersink: 7/8". Stop Collar can be furnished to control depth of cut. To cut wood plug to fit in hole over head of screw, use matching Plug Cutter (see page 2012).

### FULLER TAPER POINT DRILLS

High Speed Steel



To cut wood and plastics in one operation for the thread and shank of wood screws. Hold their sharp cutting edges longer. Recommended for most jobs whether in a drill press or in hand-held equipment. They cut well in both hard and soft wood.

Code	Screw Size	Cutting Dia.	Overall Length	List/ea
TD-5	#5	1/8"	2-3/4"	\$ 9.76
TD-6	#6	9/64"	2-7/8"	12.04
TD-7	#7	5/32"	3-1/8"	8.67
TD-8	#8	11/64"	3-1/4"	9.77
TD-9	#9	3/16"	3-1/2"	10.80
TD-10	#10	13/64"	3-5/8"	10.56
TD-12	#12	7/32"	3-3/4"	10.26
TD-SET	Set of 7 includes 1/8" through 7/32"			\$ 61.21

### FULLER TYPE "C" COUNTERSINKS



Code	Cutting Dia.	Drill Hole Size	Screw Size	List/ea
CS5	3/8"	1/8"	#5	\$ 11.81
CS6	3/8"	9/64"	#6	11.80
CS7	3/8"	5/32"	#7	11.97
CS8	3/8"	11/64"	#8	11.80
CS9	3/8"	3/16"	#9	12.87
CS10	7/16"	13/64"	#10	13.18
CS12	1/2"	7/32"	#12	13.22

### FULLER STOP COLLARS



Designed to be used with Fuller Countersinks and Counterbores. These steel collars are held solidly in place with two set screws, to control depth of counterbores. The inside diameter of the stop collar fits the outside diameter of the Countersink or Counterbore.

Code	Size	List/ea
SC38	3/8" Ins. Diameter	\$ 4.90
SC-SET	Set of 7 includes (1) 1/2", (1) 7/16" and (5) 3/8" Ins. Diameter stop collars	34.51

Taper Point Drill shown here with Countersink and Stop Collar

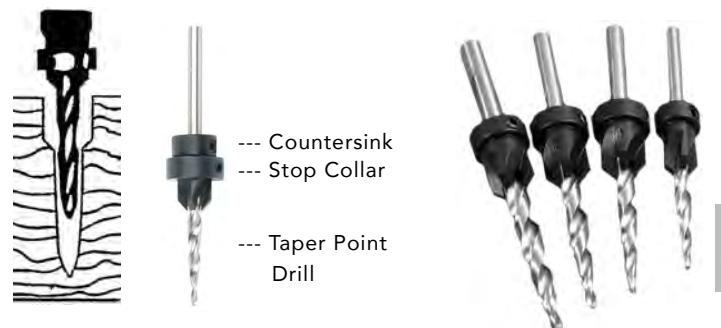



## COUNTERSINKS

### AMANA COUNTERSINKS - CARBIDE TIPPED

2-Wing for Wood Screws

Maximum 3/8" depth of cut

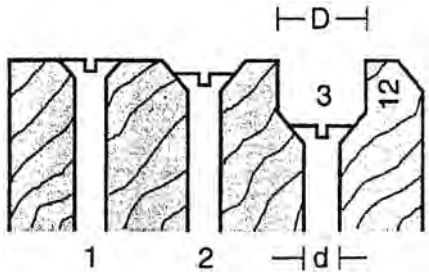

Tool No.	Suggested Wood Screw Size	Accepts *Drill Dia.	'D' Countersink Dia.	List
55202	#6	1/8	3/8	\$ 42.11
55204	#6	9/64	25/64	42.01
55208	#8-#9	11/64	13/32	45.60
55210	#10	3/16	13/32	46.91

Replacement set screws  
(2 required) No. 67092.



Drill bits included with each size.

**Note:** 5/16" shank on tools 55200 through 55208.

## HOLE SAWS



### LENOX VARIABLE PITCH HOLE SAWS



To cut wood, plastic and metal. The variable pitch can reduce labor and costs, and its faster cutting and longer life outlasts 6 pitch saws in most applications. High speed steel M3 cutting edge with varying tooth sets and gullet depths. 4-6 teeth per inch.

Code	Size	List/ea
HS134	1-3/4"	\$ 23.34
HS2	2"	22.64
HS218	2-1/8"	25.87
HS238	2-3/8"	25.90
HS214	2-1/4"	24.31
HS212	2-1/2"	29.48
HS234	2-3/4"	28.18
HS418	4-1/8"	47.91

### HOLE SAW ARBORS AND PILOT DRILLS

High Speed Steel



**58-09**  
3/8" Hex Shank



**58-08**  
3/8" Hex Shank  
w/2 pins

Code	Fits Sizes:	List/ea
58-09	9/16" thru 1-3/16"	\$ 21.76
58-08	1-1/4" thru 6"	36.88



## SCREWDRIVER BITS

X - Prefix for extra hardness bits to be used for driving sheet metal or case hardened screws.

I - Prefix for intermediate hardness bits to be used for driving heat-treated screws and for impact use.



1" Standard Length



Long Length

### FOR PHILLIPS SCREWS - 1/4" Hex Insert

440 Series

Code	Pt. Size	O.A. Length	List/ea
I440-1	1	1"	\$ 1.30
X440-1	1	1"	1.43
QS440-2-I	2	1"	2.31
X440-2	2	1"	1.74
I440-3	3	1"	2.90
X440-3	3	1"	1.64
I440-22	2	2"	5.71
X440-22	2	2"	3.04
X440-23	2	3"	6.27
X440-215	2	2-1/2"	2.41

### FOR POZI DRIVE SCREWS

1/4" Hex Insert, 440 Series

11769	2	1"	\$.82
X440-3-PZD	3	1"	3.05
QS440-3-PZD	3	1"	1.87



### FOR PHILLIPS SCREWS

1/4" Hex Shank, 446 Series

I446-2	2	1"	\$ 1.83
X446-1	1	1"	1.61
X446-2	2	1"	1.71
QS446-2-I	2	1"	2.17
11759	2	1"	.86
11760	2	1"	1.23



### FOR PHILLIPS SCREWS

5/16" Hex Shank  
480 Series

I480-2	2	1-1/4"	\$ 4.50
--------	---	--------	---------



### SQUARE DRIVE BITS



1/4" Hex Insert



1/4" Hex Power Drive

Code	Description	Ctn	List/ea
11774	1" Square Dr, #1	10	\$.58
11778	1" Square Dr, #2	10	1.41
QS954-2-I	1-15/16" Square Dr, #2	10	3.93
QS954B-2-I	3-1/2" Square Dr, #2	10	7.57

### FOR PHILLIPS SCREWS

1/4" Hex Power Drive



**QS492-I**  
Phillips Power Magnetic  
Impact Drive Bit

**11905**  
Phillips Power Bit. Use  
to drive Phillips screws  
with # 6, 7, 8, 10



**QS492B**  
Phillips Magnetic Power Bit.  
Used to drive Phillips screws  
with # 5, 6, 7, 8, 10

Code	Pt. Size	O.A. Length	List/ea
QS492-I	2	1-15/16"	\$ 1.63
11905	2	1-15/16"	3.27
QS492B	2	3-1/2"	5.67

### Note:

When a #2 bit is needed we recommend the #2 446 Apex series for #5, #6 and short to medium #8 screws (this bit is also known as a #2 recess bit). The 446 series is commonly used to mount drawer slides, face frame plates, and Amerock style hinges.

The #2 440 Apex series is recommended for driving #8 and #10 screws (the 440 will fit smaller screws too, it just performs best on larger screw heads).





## BITS

## BIT HOLDERS

### MAGNETIC POWER BITS

Quickscrews



6" Power Bit, Phillips or Square Drive. Fits standard bit holder. Can be used with the TSM10 Castle Pocket Boring Machine. Drive face frame screws easily at low angles.

Pack: 10 ea.

<u>Code</u>	<u>Description</u>	<u>List/ea</u>
12694	6" Phillips Drive #2	\$ 6.22
12698	6" Square Drive #2	5.91

### SCREWDRIVER BIT

Square/Phillips Drive Combo Head



The 13113 combo head screwdriver bit has both Square drive and Phillips drive "teeth." This makes it a fine bit to use with the Quadrex white screws as well as the Spax screws. Fills both the Square drive and Phillip's recess of a Spax screw for max driving power.

<u>Code</u>	<u>Description</u>	<u>List</u>
13113	Combo Head Bit	\$ 3.99

### MAGNETIC BIT HOLDER



11794 or M490

Use With 1/4" Hex Insert Bit. Body Dia: 1/4"

<u>Code</u>	<u>Manufacturer</u>	<u>Overall Length</u>	<u>Pack</u>	<u>List/ea</u>
11794	Quickscrews	2-7/8"	1 ea.	\$ 9.88
M490	Apex	3"	1	28.50



### QUICK RELEASE

### MAGNETIC BIT HOLDER

Quickscrews



14203

Stainless Steel Magnetic Bit Holder use with any type insert bit works in any standard drill chuck - Quick Release & Super Magnetic. 1/4" x 3".

<u>Code</u>	<u>Description</u>	<u>List/ea</u>
14203	Quick Release Bit Holder	\$ 31.63

## VIX BITS

### VIX BITS



For speedy accurate drilling. Vix Bit is self-centering. It saves hours of time in accurately drilling holes for hinges, door butts, window pulls, door latch bolts & all hardware using screws. Precision built, it drills wood, metal, plastics, etc. Hardened drill guide. Adjustable for depth. Fully guaranteed.

Code	Description	Ctn	List/ea
5VI	7/64", Hex Drive	10 ea.	\$ 18.37
9VI	9/64", Hex Drive	10	19.14
12VI	11/64"	10	61.16
5MM-VI	5mm	10	51.91
14VI	1/4"	1	56.74

### Replacement Bits

Code	Size	Ctn	List/ea
DRILL BIT-5	7/64"	10 ea.	\$ 4.02
DRILL BIT-9	9/64"	10	4.18
DRILL BIT-12	11/64"	10	7.44
DRILL BIT-5MM	5mm	10	8.13

## FULLER STANDARD PLUG CUTTERS



Designed for clean cutting and hardened for long life. These four-bladed Plug Cutters do not eject the plugs - they remain in the board and can be broken out with a screwdriver, or the board can be sawed to free the plug. The tool cuts fast and makes a smooth-chamfered plug for easy starting in the counterbored hole.

Code	Plug Dia.	Max. Length	Shank Dia.	List/ea
PC38	3/8"	1/2"	3/8"	\$ 24.42
PC716	7/16"	1/2"	3/8"	24.37
PC12	1/2"	1/2"	3/8"	28.61
PC-SET	Set of all three on a Labeled Block			\$ 72.37

## DRILL JIGS

### TP-1934 DRILL GUIDE SET FOR KNOBS/PULLS

Built for speed, the TP-1934 Cabinet Hardware Jig installs knobs and handles on doors and drawers. Saves tedious hours of measuring, clamping or making jigs.

- For knobs or pulls up to 12" C/C
- Case hardened steel bushings
- Reversible for LH or RH doors
- Versatile - measures for Euro hinge plates and shelf pin holes, too

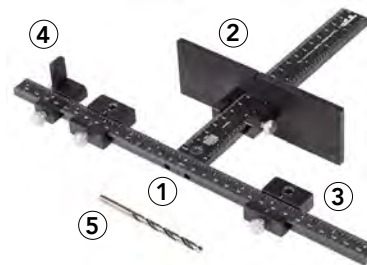

#### Includes:

- 1) 12" T-Square w/ Center Bushing
  - 2) Large Stop
  - 3) 2x Sliding Drill Guides
  - 4) Sliding End Stop
  - 5) 5mm Drill Bit
- Carrying Case

TP-1934

### Extension Set - TP-2312-NC

Extension Set for TP-1934 Jig. Allows up to 38" C/C (960mm) handles and stop for drawer fronts up to 42". Doubles as a portable 32mm shelf pin jig. Reversible.



#### Includes:

- 1) TP-ERA 17-1/2" Extended Ruler
- 2) Double Bracket
- 3) 2x line bore Extension Bars for up to 36" of 32mm line drilling
- 4) 5mm Drill Bit w/ stop collar

### Extended Ruler Attachment - TP-ERA

Eliminates the need to center your cabinet hardware jig on every drawer front. Allows up to 38" C/C (960mm) handles and stop for drawer fronts up to 42".

#### Includes:

17-1/2" ruler w/ 2 sided print, bracket for T-square connection and 2 extra thumbscrews.



Code	Description	List/ea
TP-1934	Hardware Jig	\$ 385.68
TP-2312-NC	Extension Set	265.00
TP-ERA	Ext. Ruler Attachment	100.00



## JOINING TOOLS

### LAMELLO JOINING BISCUITS

Beech



Oval jointing plates fit easily into slot & allow adjustment for perfect alignments without jigs. Dampness of glue swells plate to great strength. Made of compressed beech. Will join panels to 3/8" thick.

**Sold in full cartons only.**

<u>Code</u>	<u>Size</u>	<u>Ctn</u>	<u>List/M</u>
0LA	1-3/4" Plate	1000	\$ 89.40
10LA	2-1/8" Plate	1000	89.40
20LA	2-1/2" Plate	1000	92.98

### LAMELLO PLATE JOINING TOOL - Special Order

Classic X  
List \$



#### **Special Order**

A versatile biscuit joiner, Classic X installs 15 different Lamello joining elements, and it offers four additional applications besides biscuit and connector joining:

- Cutting of grooves for tongue and groove connections
- Cut expansion gaps for wood ceilings and floors
- Wood repairing of resin pockets and small defects
- Trimming of solid wood or plastic edges

#### Features:

- Powerful 780 watt motor
- Flush-sided swiveling front with notches at angles 22.5, 45 and 67.5 degrees
- Quick adjustment for 6 cutting depths
- Groove cutter with 6 alternating teeth
- Height adjustable flush-sided front stop square
- Anti-slip pads
- Central locking for quick change of cutter

### PLATE JOINER KIT

Model **557PC**  
List \$ 522.82



- 7.5 Amps, 120 VAC
- Fence tilts from 0° to 135° with positive adjustable stop at 90°
- Precise micro height-adjustment knob for perfect placement of biscuits
- Includes both 2" and 4" diameter blades for standard and face-frame biscuits
- Lock-on trigger
- Seven position rotating depth-stop for FF, #0, #10, #20, Simplex, Duplex and Max (#6) biscuits
- Spindle lock for easy blade changes
- Includes plate joiner #557, 2" blade #5559, 4" blade #5558, centering plate #888776, spanner wrench #886041, dust bag #883175, chip deflector #886490, and operating manual

## ZETA P2



### ZETA P2 FOR BISCUITS AND RTA FITTINGS

**Zeta P2**  
 # 101402S



The Zeta P2 machine for the evolving P-System saves you time everyday! The P-System depth adjuster allows you to easily choose between five P-System depths. The cutter plunges into the preset depth, then follows a vertical movement up and down for the profile cut called the VMD Vertical Mechanical Drive, which can be simply switched off so that the Zeta P2 can be used as a standard biscuit joiner (Standard cutter is sold separately - #132000).

The vertical mechanical drive (VMD) is the core of the machine and the key to the Clamex P-14 and Clamex Medius connector system. Model 101402S comes with a carbide tipped profile groove cutter. Comes in a Systainer box.

- P-System Depths - Depth 14 is for Clamex P-14 and Tenso P-14, Depth 10 for Clamex P Medius
- Swivelling front stop and stop square are flush on both sides
- Large fence surfaces
- 800 watt motor with electronic control
- Rotating depth adjuster with 6 standard stops
- Base plate and fence is flush for side reference for fast positioning on edge of the work piece
- Pivoting trigger to switch off the VMD function to use as a standard biscuit joiner (please note that the standard cutter is sold separately)
- The quickest and most economical way to install knock down fittings

Code	Net
101402S	\$ 1596.50

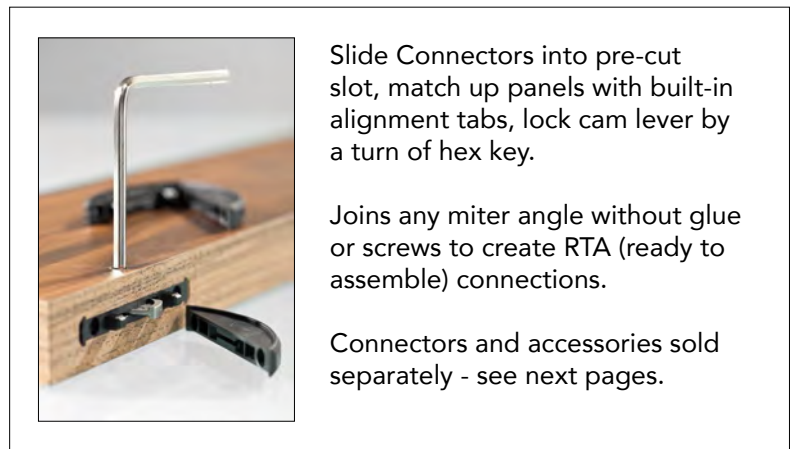
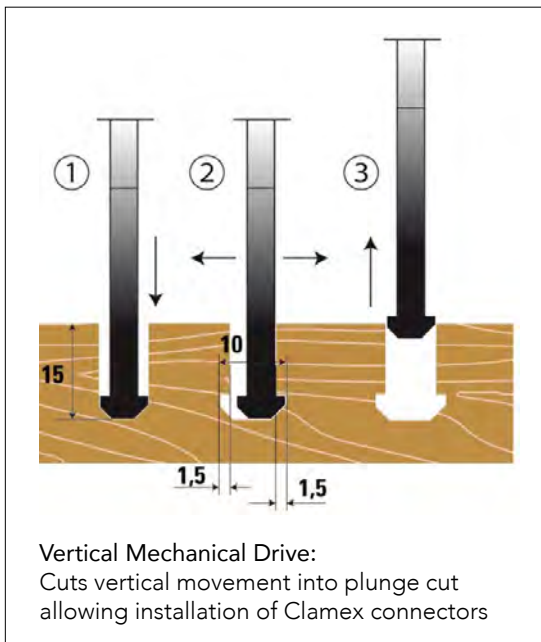

See video at [macpac1.com/videos#lamello](http://macpac1.com/videos#lamello)

See Micro Depth Adjustment for Lamello Zeta P2 video at [MacMurrayPacific.com/videos#lamello2](http://MacMurrayPacific.com/videos#lamello2)



**ZETA P2** *continued*  
**P2 SYSTEM CONNECTORS**



**Clamex P**  
The Detachable, Eccentric Cam Connector slides into place--No Tools Required



- Fits into T-groove slot made with a Zeta P2 machine: Simply slide connectors in pre-cut slot, match up panels with built in alignment tabs, lock cam lever by a turn of a hex key.
- Joins any miter angle without glue or screws to create nearly invisible Ready To Assemble (RTA) connections.

**Clamex P-14 - For Panels from 16mm**  
66 x 28 x 9.7mm

Code	Box	Net/Bx
145334	80 pr	\$ 135.20
145346	300 pr	458.35
145356	1000 pr	1364.75

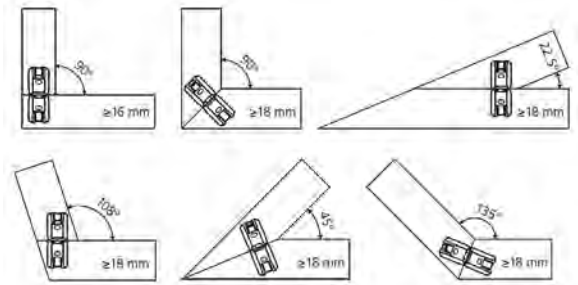

**Clamex P-10 - For Panels from 13mm**  
52 x 19 x 9.7mm

Code	Box	Net/Bx
145372	80 pr	\$ 135.01
145373	300 pr	445.00
145374	1000 pr	1325.00

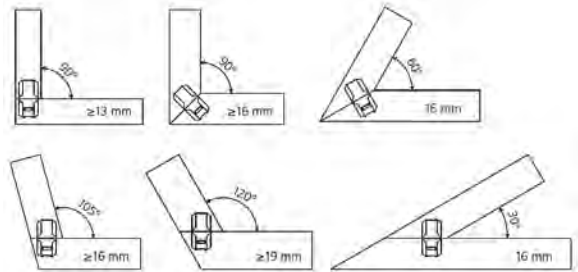

**Clamex Flexus P-14**

Detachable furniture connector like the Clamex P-14 above, but with flexible positioning pins.



- Flexible assembly sequence – Flexible positioning pins allow freely selectable assembly sequence
- Simple alignment – Pins align the workpiece and keep it in position
- Versatile assembly – Bevelled and movable positioning pins enable the tilting of the workpiece in both directions
- Installation of fixed shelves – Fixed shelves or vertical separators can be installed in an assembled cabinet unit
- Compatible with all Clamex P connector halves without levers – P-14 without lever, P-10 without lever and P-10 Medius without lever

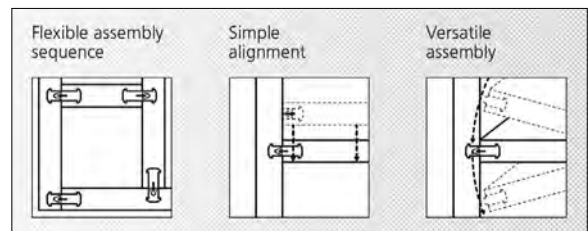

Code	Box	Net/Bx
145315	80 pr	\$ 135.01
145316	300 pr	458.35

**ZETA P2**



**ZETA P2 continued**  
**P2 SYSTEM CONNECTORS**

**Tenso P**

Glue Faster: Invisible  
 Self-Clamping Glue Aid



A self-clamping fitting with three functions: alignment, clamping and connecting. The high clamping force allows work pieces to be glued without clamps or pressure. Anchors the work piece in just seconds, without tools.



**Tenso P-14 - For Panels from 13mm**  
 66 x 28 x 9.7mm

Code	Box	Net/Bx
145415	80 pr	\$ 77.25
145425	300 pr	265.21



**Tenso P-10 - For Panels from 12mm**  
 52 x 19 x 9.7mm - Includes Preload clip

Code	Box	Net/Bx
145418	80 pr	\$ 95.00
145438	1000 pr	910.01



**Preload Tool**  
 Tenso P-10/14 Expansion Clip  
 Assembly Device.  
 #145400 Net \$ 7.00/ea



**Preload Clips**  
 Allows the Tenso P-14 to be preloaded by hand in a simple process before glue is applied. 300/Bx, sold per box.  
 #145426 Net \$ 57.20/bx

**ZETA P2 continued**  
**P2 SYSTEM CONNECTORS**

**Bisco P**

Alignment aid for Clamex & Tenso P-10 & P-14

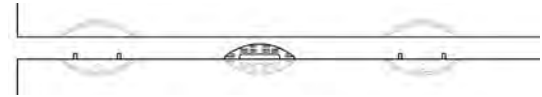

An alignment element that is part of the Clamex P system. It is easily installed using the Zeta P2 or CNC as it fits easily into the P-system groove without changing the cutter. Bisco P is 7mm thick, made of thick plastic and used in combination with Clamex P. The element is not only used for alignment of panels but can be used for glueing, and increasing shear strength.

**Bisco P-14**  
 65 x 27 x 7mm

Code	Box	Net/Bx
145301	80 ea	\$ 40.18
145302	300 ea	105.00



7mm thickness

**Bisco P-10**  
 52 x 19 x 7mm

Code	Box	Net/Bx
145304	80 ea	\$ 42.00

**P-SYSTEM PROFESSIONAL CONNECTOR SET**

Lamello #145312

Contains P-System connectors in all sizes and includes assembly tools for the Clamex and Divario.

**Includes:**

- 120 prs Clamex P-14
- 30 prs Clamex P-14/10 Flexus
- 30 prs Clamex P-10
- 80 pairs Tenso P-14 incl. clip
- 30 pairs Tenso P-10 incl. clip
- 20 pcs Bisco P-14
- 20 pcs Bisco P-10
- 80 pairs Divario P-18
- Divario Installation Tool/Drill/Marking Gauge
- Clamex P Installation Tool



Special Order Only.  
 Call for Current Pricing.



**ZETA P2 continued**  
**P2 SYSTEM CONNECTORS**

**Divario P-18**

Self-clamping, invisible fitting for slide insertion. 65 x 16 x 9.7mm

Code	Box	Net/Bx
145550	80 pr	\$ 95.40
145560	300 pr	329.61



- Completely invisible joint
- Joins & clamps during insertion for perfectly closed joints
- Narrow element for the use in shelves from 19mm
- No resistance while inserting until shortly before building the clamping force
- Insertion of shelves after transport for lower transport weight
- Divario installation tool # 125500 sold separately (required for fixing the Divario in the workpiece)

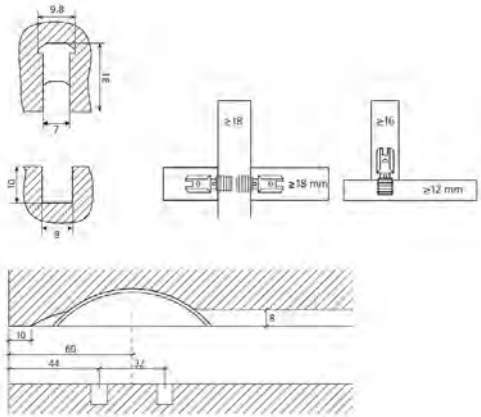

**Installation Tool**



Divario P-18 Installation Tool (Required for fixing the Divario in the workpiece).

#125500 Net \$ 89.00/ea

**Marking Jig Kit**

Including drill with centering point and rotatable depth adjuster for manual, precise drilling of Divario drill holes.

#125510 Net \$ 145.60/st



**ZETA P2 continued**  
**ACCESSORIES**

**Carbide Cutters**



Clamex P Carbide Cutter. Replacement T-Groove cutter for Zeta P2. 100 x 7 x 22mm.

#132141 Net \$ 149.80/ea



This 6 Tooth Carbide Cutter is the blade to use for the Zeta P2 when you want to use it as a cutter for standard biscuits (20LA).

#132000 Net \$ 139.70/ea



P-System groove cutter, DP (diamond) for Zeta. Produce grooves more effectively and faster - good for up to 10,000 to 15,000 slots. 100x7x22mm.

#132140 Net \$ 225.00/ea



4mm Hex Key for all Clamex connectors.

#271945 Net \$ 1.26/ea



P-Mounting Fitting Tool, Flexible Hex Key. 4mm x 30mm Hexagonal Screwdriver, 290mm Length, for all angles, fast and flexible.

#251993 Net \$ 45.00/ea

## FESTOOL

## DOMINO JOINERS

### Domino DF 500 Q Mortise and Tenon Joiner Set

Domino Joiner DF 500 Q Set (including trim stop and cross stop) for fast, easy and strong mortise and tenon joining.

- Unique, patented cutting action that rotates and oscillates to create perfect, clean, and repeatable mortises every time.
- Mortise width adjustment with the turn of a dial allows for easier alignment when joining panels.
- Pivoting Fence allows you to create angled mortises from 0-90° with positive stops at 22.5°, 45°, 67.5°.
- Indexing pins for quick alignment against the edge of the workpiece for accurate placement.



### DOMINO DF 500 Q

Includes:

- DOMINO cutter D 5
- Support bracket
- Wrench
- Plug-it cord
- Systainer
- Trim stop
- Cross stop

Code	Price
576423	\$ 1199

### Beech Domino Tenons



Large and Small cartons available

Code	Thick x Width x Length	Ctn Qty	Ctn
495661	4mm x 17mm x 20mm	450	\$ 31
493296	5mm x 19mm x 30mm	1800	119
493297	6mm x 20mm x 40mm	1140	119
493298	8mm x 22mm x 40mm	780	119
493299	8mm x 22mm x 50mm	600	119
493300	10mm x 24mm x 50mm	510	119
494938	5mm x 19mm x 30mm	300	31
494939	6mm x 20mm x 40mm	190	31
494940	8mm x 22mm x 40mm	130	31
494941	8mm x 22mm x 50mm	100	31
494942	10mm x 24mm x 50mm	85	31

### Beech Stock Tenons

Made to be cut-to-length



498686	8mm x 750mm	36	\$ 92
498687	10mm x 750mm	28	92

### Beech Domino Tenon Assortment

Assortment includes 5 Cutters, Domino Assortment Systainer, and 1060 tenons.

Tenon assortment:

4 x 20mm (450), 5 x 30mm (225), 6 x 40mm (150), 8 x 40mm (100), 8 x 50mm (75), 10 x 50mm (60)

Cutter assortment:

D4mm (1), D5mm (1), D6mm (1), D8mm (1), D10mm (1)



Code	Price/Asst
576794	\$ 395

### Sipo Wood Domino Tenons

For Outdoor Applications.

Made from African Mahogany.

Resistant to moisture, decay, fungus and termites.

Large and Small cartons available.



Code	Thick x Width x Length	Ctn Qty	Ctn
494859	5mm x 19mm x 30mm	900	\$ 139
494860	6mm x 20mm x 40mm	570	139
494861	8mm x 22mm x 40mm	390	139
494862	8mm x 22mm x 50mm	300	139
494863	10mm x 24mm x 50mm	255	139
494869	5mm x 19mm x 30mm	300	57
494870	6mm x 20mm x 40mm	190	57
494871	8mm x 22mm x 40mm	130	57
494872	8mm x 22mm x 50mm	100	57
494873	10mm x 24mm x 50mm	85	57

### Sipo Stock Tenons

Made to be cut-to-length



498690	8mm x 750mm	36	\$ 139
498691	10mm x 750mm	28	139

### Domino DF500 Cutters

Carbide Tipped



Code	Description	Price
495663	For 4mm Tenons	\$ 49
493490	For 5mm Tenons	53
493491	For 6mm Tenons	52
493492	For 8mm Tenons	53
493493	For 10mm Tenons	54





## DOMINO JOINERS

## FESTOOL

### DOMINO DF 500 CONNECTOR ASSORTMENT

works with Domino DF 500 Q Joiner Set

DOMINO connectors make knock-down joinery simple and stable. Quickly and easily assemble, separate, and reassemble your work – from corner panel joints to center panel joints to joints between a series of holes. For use in materials with a min. thickness of 3/4" (18mm). Components can also be sold separately.



**Includes:**

- (90) Basic Structure Connectors
- (30) Center Panel Connectors
- (50) Dark Brown (50) Silver (50) White (50) Grey Cover Caps
- (20) Domino Tenons D 8 x 36mm
- (1) D15 drill template
- (1) D15 CE hinge location cutter
- (1) screwdriver,
- (1) Systainer box.

<u>Code</u>	<u>Price/Set</u>
576797	\$ 399



Connectors

### DOMINO DF 500 CONNECTOR SET COMPONENTS

Sold individually

<u>Code</u>	<u>Description</u>	<u>Pack</u>	<u>List</u>
203165	Hinge location cutter	1	\$ 64
203166	Split Anchor	50	129
203167	Bolts w/ external/internal thrd	25	97
203168	Split Anchor	50	109
203169	Bolts w/ external/internal thrd	25	86
203171	Dark Brown cover caps	50	10
203172	Silver cover caps	50	17
203173	White cover caps	50	10
203174	Grey cover caps	50	10
203175	Beech tenons	130	20

### DOMINO DF 700 CONNECTOR ASSORTMENT

works with Domino DF 700 Joiner Set

Domino fasteners work with the Domino XL (DF 700) Joiner to create flat or corner joints. Corner and flat connectors provide simple and quick connections without the need for templates or complex measuring.



- For frame and board joints; corners and flats
- Extremely quick. No template or other accessories required
- 30mm material thickness or higher
- Extremely stable, high pull-out and load forces
- Can be detached again quickly

<u>Code</u>	<u>Price/Set</u>
576795	\$ 325

Domino Connector Set Includes:



**#201349**

(32) Split (expansion) Anchors  
For permanent placement.



**#201350**

(32) Anchor Bolts  
For corner connections, including 64 Half-Shells.



**#201351**

(32) Cross Anchors  
Including screws for locking Anchors or Double Bolts.



**#201352**

(16) Double-headed Bolts  
For flat connections, including 64 Half-Shells. Can be clipped using 2 or 4 Half-Shells depending on the required alignment.



**#201499**

(32) Beech Domino Tenons

D14x75, exactly matched to the dimensions of the corner and flat connectors. Serves to provide alignment - in addition to the connectors.



201354



201356



201355



**#201498**

(64) Half-Shells  
For widening and pressure distribution when using Cross Anchors in materials such as particleboard or MDF. (a total of 192 in entire set)

(32) Connector Caps

Cosmetic plastic cover cap for exposed mortise holes. Available in 3 colors: dark brown, light brown, and silver.



**#271945**

4mm Hex Wrench  
for tightening screws



## FESTOOL

### Domino XL DF 700 Mortise and Tenon Joiner Set

Domino Joiner DF 700 EQ Set (including trim stop and cross stop) for fast, easy and strong mortise and tenon joining.

- Unique, patented cutting action that rotates and oscillates to create perfect, clean, and repeatable mortises every time.
- Mortise width adjustment with the turn of a dial allows for easier alignment when joining panels.
- Pivoting Fence allows you to create angled mortises from 0-90° with positive stops at 22.5°, 45°, 67.5°.
- Indexing pins for quick alignment against the edge of the workpiece for accurate placement.



## DOMINO JOINERS

### DOMINO XL DF 700

Includes:

- DOMINO cutter D 12
- Support bracket
- Wrench
- Plug-it cord
- Systainer
- Trim stop
- Cross stop

Code	Price
574447	\$ 1599

### Beech Domino Tenons



Large and Small cartons available

Code	Thick x Width x Length	Ctn Qty	Ctn
493298	8mm x 22mm x 40mm	780	\$ 119
493299	8mm x 22mm x 50mm	600	119
493300	10mm x 24mm x 50mm	510	119
494940	8mm x 22mm x 40mm	130	31
494941	8mm x 22mm x 50mm	100	31
494942	10mm x 24mm x 50mm	85	31
498216	12mm x 26mm x 100mm	100	72
498217	12mm x 26mm x 140mm	90	72
498218	14mm x 28mm x 100mm	80	72
498219	14mm x 28mm x 140mm	70	72

### Beech Stock Tenons

Made to be cut-to-length



498686	8mm x 750mm	36	\$ 92
498687	10mm x 750mm	28	92
498688	12mm x 750mm	22	92
498689	14mm x 750mm	18	92

### Sipo Stock Tenons

Made to be cut-to-length



498690	8mm x 750mm	36	\$ 139
498691	10mm x 750mm	28	139
498692	12mm x 750mm	22	139
498693	14mm x 750mm	18	139

### Beech Domino Tenon Assortments

#### Assortment 8/10mm

Includes 2 Cutters, Systainer, and 380 tenons.

Tenon assortment:  
8 x 50mm (50), 8 x 80mm (36),  
8 x 100mm (36), 10 x 50mm (80),  
10 x 80mm (52), 10 x 100mm (52)

Cutter assortment:  
8mm (1), 10mm (1)



Code	Price/Asst
576791	\$ 395

#### Assortment 12/14mm

Includes 1 Cutter, Systainer, and 128 tenons.

Tenon assortment:  
12 x 100mm (40), 12 x 140mm (40),  
14 x 100mm (16), 14 x 140mm (32),

Cutter: 14mm



Code	Price/Asst
576792	\$ 349

### Domino DF700 Cutters

Carbide Tipped



Code	Description	Price
497868	For 8mm Tenons	\$ 72
497869	For 10mm Tenons	74
497870	For 12mm Tenons	76
497871	For 14mm Tenons	81

## FINISH NAILERS

## SENCO

### FP16XP 2-1/2" FINISH NAILER

- EZ-Clear<sup>a</sup> latch design allows for quick and easy jam clearing
- Tool Free Depth-of-Drive adjustment
- Push button integrated air duster
- Rotatable belt hook
- Tool Weight: 4 lbs (1.8 kgs)
- Air Consumption: 2.22 (SCFM)
- Single fire or bump fire



<u>Code</u>	<u>List/ea</u>
FP16XP	\$ 295.94

**Includes:**

Case, Wrenches, Tool Oil, No-Mar Pad, Swivel Plug

**Drives:**

**16 Gauge** Straight Strip  
 Finish Nails 3/4" - 2-1/2"  
 (M001002 - 7)



### SENCO FINISH NAILER - FP30XP



Weight: 3.8 lbs  
 Height: 9-5/8"  
 Length: 12"  
 Capacity: 104  
 Pressure: 70-120 psi

Drive range: 1" - 2"

<u>Code</u>	<u>List/ea</u>
FP30XP	\$ 521.62

**Drives 15 Gauge Nails:**

DA13 (1"), DA15 (1-1/4"),  
 DA17 (1-1/2"), DA19 (1-3/4"),  
 DA21 (2")

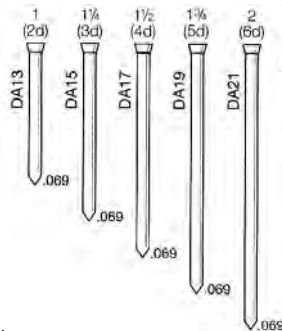

Applications: Furniture and cabinets, picture frames, construction and nailable plastic parts.

Features: Lightweight, oil-free, adjustable depth-of-drive, and belt hook adjusts to RH and LH. Case included.

### FP35 FINISH NAILER

Weight: 4.65 lbs  
 Height: 12-1/4"  
 Length: 13"  
 Magazine Capacity: 110  
 Pressure: 70-120 psi



Drive range:  
 1-1/4" - 2-1/2"

<u>Code</u>	<u>List/ea</u>
FP35	\$ 302.29

**Drives 15 Gauge Nails:**

DA15 (1-1/4"), DA17 (1-1/2"), DA19 (1-3/4"), DA21 (2"),  
 DA23 (2-1/4"), DA25 (2-1/2")

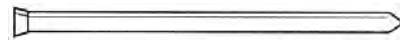

### SENCO FINISH NAILER - FP42XP



Weight: 4.7 lbs  
 Height: 11-1/4"  
 Length: 13"  
 Magazine Capacity: 104  
 Pressure: 70-120 psi

Drive range:  
 1-1/4" - 2-1/2"

<u>Code</u>	<u>List/ea</u>
FP42XP	\$ 447.89

**Drives 15 Gauge Nails:**

DA15 (1-1/4"), DA17 (1-1/2"), DA19 (1-3/4"), DA21 (2"),  
 DA23 (2-1/4"), DA25 (2-1/2")



Applications: Window and door casings, cabinets, furniture, woodworking, molding, paneling and picture frames.

Features: Superior power, adjustable depth-of-drive, oil-free design, no-mar pad increases visibility to help accurate nail placement, low recoil. Case included.



## SENCO

## BRAD NAILERS

### SENCO BRAD NAILER - SLP20XP



Height: 8-1/4"  
 Length: 9-1/2"  
 Lip Length: 3/4"  
 Capacity: 110  
 Operating Pressure:  
 70-120 psi  
 Mode of Operation:  
 Restrictive Trigger  
 Hose Fitting: 1/4" NPT

Code            List/ea  
 SLP20XP        \$ 335.45

**Drives 18 Gauge**, slight & medium headed brads.  
 Fastener range 5/8" - 1-5/8".  
 Use with AY10, AY11, AY13, AX13, AX15, AX17, AX18.

Easy side loading allows you to change brad lengths without adjusting the tool. Lightweight 2.3 lbs for easy handling and maneuvering. Oil-free design. Comfort-grip handle.

### SENCO BRAD NAILER FP18MG

Height: 9-3/4"  
 Length: 10-1/2"  
 Weight: 2.48 lbs.  
 Capacity: 110



Drives 18 Gauge brads,  
 5/8 to 2-1/8"

Code            List/ea  
 FP18MG        \$ 186.80

Durable, lightweight Magnesium body. Oil-free.  
 Air Consumption: 2.4 (SCFM). Tool-free depth adjust.  
 Selectable trigger. With Case, swivel plug.

### SENCO BRAD NAILER FP25XP



Height: 9.9"  
 Length: 9.8"  
 Weight: 2.7 lbs.  
 Capacity: 110  
 Operating Pressure:  
 70-120 psi

Code            List/ea  
 FP25XP        \$ 382.56

**Drives 18 Gauge**, slight & medium headed brads.  
 Fastener range 5/8" - 1-5/8".  
 Use with AY10, AY11, AY13, AX13, AX15, AX17, AX18.

Tool-free depth adjust Oil-free design. Comfort-grip handle. On-tool Construction Ruler for making quick measurements.

### 18 Ga. Straight Strip Brad Nails

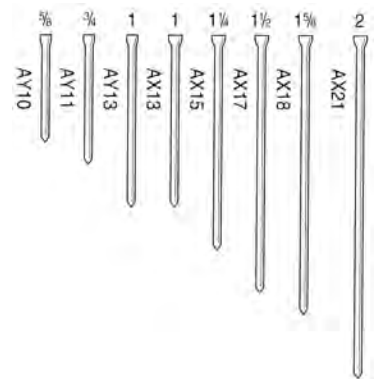

AX = Medium Head Brad  
 AY = Slight Head Brad

### Galvanized Finish

Code	Length	Qty	Boxes/	
			Case	List/bx
AY10	5/8"	5000	16	\$ 63.11
AY11	3/4"	5000	16	55.28
AY13	1"	5000	10	53.16
AX13	1"	5000	10	33.35
AX15	1-1/4"	5000	10	33.84
AX17	1-1/2"	5000	8	40.59
AX18	1-5/8"	5000	8	40.29
AX19	1-3/4"	5000	6	60.51
A202009	2"	800	5	14.57
AX21EAAN	2"	5000	6	54.54

## STAPLE GUNS

## SENCO

### SLS20XP STAPLERS

Ultra lightweight, Quiet muffler and Oil Free design. Use on upholstery, cabinets, casebacks, insulative sheathing and lattice. Adjustable depth of drive.

Tool weight: 2.5 lbs.



#### **SLS20XP-L \$ 505.51**

Crown: 1/4"

Lengths: 3/8" - 1-1/2"

Capacity: 168

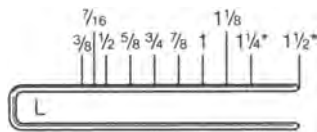

L06-L17

#### **SLS20XP-M \$ 582.75**

Crown: 3/8"

Lengths: 3/8" - 1-1/2"

Capacity: 168

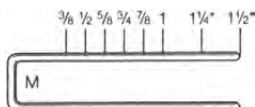

M06-M17

### SKSXP 1/4" CROWN STAPLER

For cabinet & furniture assembly, door & window casings, trim, moldings, aluminum and vinyl siding, roof sheathing and decking.

Lightweight: 2.3 lbs.

Comfort grip handle and Oil Free design.



Crown Width: 1/4",  
 7/8" to 1-1/2" lengths

Capacity: 145-158

Code  
 SKSXP

List/ea  
 \$ 659.93

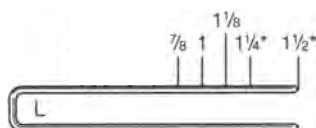

L12-L17

### SLS18MG 1/4" CROWN STAPLER

- Ultra-lightweight for ease of use and maneuverability
- Metal cylinder for increased durability
- Re-load indicator on magazine
- Tool Weight: 2.6 lbs (1.8 kgs)
- Air Consumption: 2.4 (SCFM)



Includes: Case, Swivel Plug, Wrenches, No-Mar Pad

Crown: 1/4", Med. Staples  
 3/8" to 1-1/2" lengths

Code

SLS18MG

List/ea

\$ 208.41

### SLS25XP MEDIUM DUTY STAPLERS

- Ultra-lightweight for ease of use and maneuverability
- Tool Weight: 2.67 lbs (1.21 kgs)
- Dual Action Trigger
- Oil Free design
- Quiet Muffler

Applications: Drawers, Cabinet frames, paneling, moulding/trim, pre-finished gypsum and siding.



#### **SLS25XP-L \$ 475.98**

Crown: 1/4"

Lengths: 3/8" - 1-1/2"

Capacity: 168

#### **SLS25XP-M \$ 483.26**

Crown: 3/8"

Lengths: 3/8" - 1-1/2"

Capacity: 168

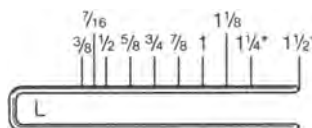

L06-L17

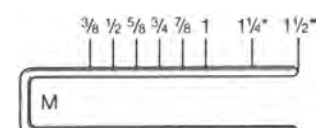

M06-M17



# SENCO

## NS20XP 7/16" CROWN STAPLER



### **NS20XP**

Crown: 7/16"  
Lengths: 1 - 2"  
Capacity: 160  
Drives Staples:  
N13 - N21

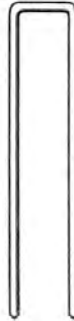

16 Ga. Fasteners  
Width: .062  
Thickness: .055

<u>Code</u>	<u>List/ea</u>
NS20XP	\$ 443.28

- Shoots 16 & 17 Ga. staples
- EZ-Clear latch allows for quick access to clear fasteners
- New drive track design enhances drive performance and virtually eliminates jams, skipping and misfires
- Tool Weight: 5.1 lbs (2.3 kgs)
- Air Consumption: 3.5 (SCFM)
- Pressure: 70-120 psi
- Dual Action Trigger

## SENCO PARTS KITS

Carded parts kits for Senco tools.  
Pack: 1 card.



<u>Code</u>	<u>Description</u>	<u>Tool</u>	<u>List/cd</u>
EC0215	C-Driver	LS	\$ 36.77
EC0178	3/16" CSK Driver	SKS	38.95
YK0372	B-Lower Rings	SLP20	101.00
YK0376	Repair Kit	SFN1, SKS, SPS	110.65

## SENCO PNEUMATIC TOOL OIL

Pack: 1 each

<u>Code</u>	<u>Size</u>	<u>List/ea</u>
PC0101	1/2 pint	\$ 6.18
PC0102	Quart	18.95



## SENCO PC1010 ELECTRIC COMPRESSOR

1/2 HP For Finish & Trimwork

- Idea for finish and trim work
- Quiet 68 dBZ
- Light - 20 lbs.
- Heavy duty induction motor



<u>Code</u>	<u>List/ea</u>
PC1010	\$ 317.49

13" H x 14" L x 10" W  
Tank Storage: 1 Gallon  
Tool Weight: 20 lbs.  
Current Draw/  
Max AMPs: 4 amp @ 115V  
Horsepower: 0.5

Pump: Oil free  
SCFM at 90 psi: 0.7  
Max Pressure: 125 psi  
Pump up time:  
128 seconds (0-125 psi)  
Recovery time:  
35 seconds (90-125 psi)

## PC0947 COMPRESSOR / BRAD GUN KIT

Includes FP18 & PC1010

### **KIT INCLUDES:**

- FinishPro®18 Brad Nailer
- 1 gallon electric oil-less compressor, 1/2 HP PC1010
- 1/4" x 25' coil hose
- All necessary air fittings
- Tool oil & Safety glasses
- Variety pack of 18 ga. brad nails



<u>Code</u>	<u>List/ea</u>
PC0947	\$ 388.06

## SENCO GUNS

### FP21LXP 2" PINNER

- Powerful - ensures complete drive into hard substrates
- Automatically adjusts for different fastener lengths
- Ergonomic handle for all-day comfort
- Ultra-narrow nose for tight corners
- Tool Weight: 2.7 lbs (1.2 kgs)
- Air Consumption: 1.2 (SCFM)



Code List/ea  
 FP21LXP \$ 506.73

Includes: Case, Wrenches, Tool Oil, No-Mar Pad, Swivel Plug

Drives: 21 Gauge Straight Strip Medium Head Pins 5/8" - 2".

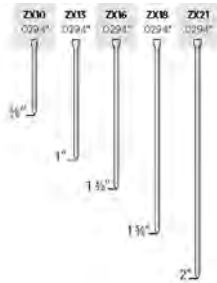

### SENCO 23 Ga. PIN NAILERS

Fasten intricate millwork, casing, and other pieces of trim without splitting or requiring any touch up work. Drives 23 Ga. A10 micro pins into dense hardwoods commonly used in various moldings.



**TN11G1 \$ 495**

Shoots 23 Gauge  
 1/2" - 1-3/8" pins

Weight: 2.41 lbs  
 Height: 7-13/16"  
 Length: 8-9/16"

Capacity: 100  
 Range: 1/2" - 1-3/8"



**TN11L1 \$ 685**

Shoots 23 Gauge  
 1/2" - 2" pins

Weight: 2.86 lbs  
 Height: 9-3/16"  
 Length: 8-11/16"

Capacity: 100  
 Range: 1/2" - 2"



**Straight Strip Micro Pins**  
 A10 1/2" - 2"

## GREX PINNERS

### GREX TOOLS

Headless Pinners and Pins

#### 23 Gauge Headless Pinners

Code	Description	List/ea
P635	3/8" - 1-3/8" Pinner	\$ 372.40
P650L	3/8" - 2" Pinner w/ Lockout feature	580.00



- Pins are set 1/16" below material surface
- Magazine automatically adjusts for pin size
- Magazine angled rear cut-off allows for placement into corners
- Narrow nose design for reaching into tight areas
- No-mar rubber tip protects surfaces (two included)
- Indicator window shows when fasteners are low
- Rear exhaust w/ silencer
- Dual trigger safety system
- Quick access storage for no-mar tip and hex wrench
- Lightweight: P635 - 2.2 lbs, P650L - 2.68 lbs.

#### Headless Pins / Med Head Brads

**P6 Series**  
 23 gauge  
 Headless pins  
 10,000/box

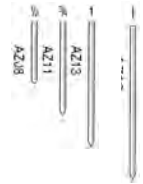

**GBN Series**  
 18 gauge  
 Brad Nails  
 Medium Head  
 5,000/box

Code	Description	List/bx
P6/10L	3/8" Headless Pins	\$ 19.87
P6/12L	1/2" Headless Pins	19.94
P6/15L	5/8" Headless Pins	19.13
P6/20L	3/4" Headless Pins	26.40
P6/22L	7/8" Headless Pins	27.45
P6/25L	1" Headless Pins	27.50
P6/28L	1-1/8" Headless Pins	21.81
P6/30L	1-3/16" Headless Pins	33.70
P6/35L	1-3/8" Headless Pins	35.70
P6/38L	1-1/2" Headless Pins	42.26
P6/40L	1-9/16" Headless Pins	36.52
P6/45L	1-3/4" Headless Pins	38.67
P6/50L	2" Headless Pins	53.19
GBN18-15	5/8" Brad Nails	\$ 28.62
GBN18-25	1" Brad Nails	30.85
GBN18-32	1-1/4" Brad Nails	31.42
GBN18-38	1-1/2" Brad Nails	32.90
GBN18-50	2" Brad Nails	34.67



## SENCO PARTS

### **PLUGS & COUPLERS**

(Do not use with Industrial Interchange Design)

#### **1/4" PLUG, MALE PIPE THREAD**

Plated Steel, Carded



Code	Size	Card	List/cd
1601DL	1/4"	1 ea.	\$ 9.96

#### **1/4" COUPLER, MALE PIPE THREAD**

Brass, Carded



Code	Size	Card	List/cd
162DL	1/4"	1 ea.	\$ 15.98

#### **1/4" PLUG, FEMALE PIPE THREAD**

Plated Steel, Carded



Code	Size	Card	List/cd
1602DL	1/4"	1 ea.	\$ 7.24

#### **1/4" COUPLER, FEMALE PIPE THREAD**

Brass, Carded



Code	Size	Card	List/cd
160DL	1/4"	1 ea.	\$ 15.42

#### **1/4" COUPLER, LOCKING HOSE BARB**

Brass, Carded



Code	Size	Card	List/cd
163L	1/4"	1 ea.	\$ 21.10

#### **1/4" COUPLER, LOCKING HOSE BARB**

Steel, Carded



Code	Size	Card	List/cd
1606L	1/4"	1 ea.	\$ 10.50

### **INDUSTRIAL INTERCHANGE**

#### **PLUGS & COUPLERS**

(Do not use w/Tru-Flate Design)

#### **PLUG - Male Pipe Thread**

Code	Size	Pk	List/pk
PC0479	1/4"	2 ea.	\$ 5.32



#### **COUPLER - Male Pipe Thread**

Code	Size	Cd	List/cd
PC0503	1/4"	1 ea.	\$ 12.05



#### **PLUG - Locking Hose Barb**

Code	Size	Cd	List/cd
PC0576	1/4"	2 ea.	\$ 5.28



#### **PLUG - Female Pipe Thread**

Code	Size	Cd	List/cd
PC0477	1/4"	2 ea.	\$ 5.32



#### **COUPLER - Female Pipe Thread**

Code	Size	Pk	List/pk
PC0501	1/4"	1 ea.	\$ 9.45



#### **COUPLER - Locking Hose Barb**

Code	Size	Cd	List/cd
PC0505	1/4"	1 ea.	\$ 13.24





## HOSES

### DYNASWIVEL AIR LINE CONNECTOR

Never Fight an Air Hose Again!

#### The Problem



#### The Solution



The Dynaswivel is a patented "universal-joint" that connects portable air tools to an air line.

Swivels 360° at two pivot points allowing the air hose to drop directly to the floor while providing superb tool handling.

Improves tool maneuverability, minimizes operator fatigue and extends hose life.



Thread Size: 1/4" NPT (6mm)

Air Flow Range (LPM): up to 33SCFM (9935)

Code	Description	List/ea
94300	Dynaswivel Air Hose Connector	\$ 38.73

### "FLEXEEL" FLEXIBLE POLYURETHANE HOSE

Coilhose Pneumatic



PFE40254TR  
 Red / 25'



PFE40504T  
 Blue / 50'

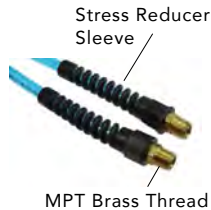

Transparent Polyurethane hose with dacron polyester inner braid reinforcement. Most flexible user-friendly air hose on the market. Low wear, less resistance to movement than traditional air hoses, naturally flexible, easy to coil. Extremely abrasion resistant, UV stabilized. Temperature range: 40° F to 165° F. 1/4" male pipe thread both ends.

Code	Description	List
PFE40254TR	Red, 1/4" ID x 25'	\$ 53.94
PFE40504T	Blue, 1/4" ID x 50'	92.91

### FLEXCOIL® COILED HOSE

Coilhose Pneumatic

With reusable strain relief fittings

Neon Green coiled hose, 1/4" I.D. x 25', 1/4" NPT Swivel & Rigid Fittings



"Self Storing"

Great for wood shops, mobile equipment, and nailing and stapling. Polyurethane. Made in the USA.

Code	Description	List/ea
PU1425AG	Coiled Hose, 1/4" x 25' w/ fittings	\$ 66.60

### HYBRID PVC AIR HOSE

Coilhose Pneumatic



**YB40254Y**

1/4" x 25' and 50' lengths

Code	Description	List/ea
YB40254Y	1/4" I.D, 25 feet, 1/4" NPT Male	\$ 37.13
YB40504Y	1/4" I.D, 50 feet, 1/4" NPT Male	48.96



## BLOW GUNS

### TYPHOON BLOW GUN

Coilhose Pneumatic

TYP2500CS



The Typhoon Blow Gun is ideal for heavy-duty clean-up and blow-off.

Meets or exceeds OSHA regulations. Variable flow trigger for controlled blow-off. Comes with a High Flow nozzle. 34 CFM @ 125 PSI, 2.1 lbs of thrust.

Has a 1/4" NPT (National Pipe Thread) in-port.

<u>Code</u>	<u>Description</u>	<u>List/ea</u>
TYP2500CS	High flow Blow Gun	\$ 44.41

### TYPHOON "PRO" BLOW GUN

Coilhose Pneumatic

2501CS-TYP



All-metal design for high volume users. Chrome plating on an aluminum body resists chemicals and solvents. Easy to clean.

Variable flow control for precise air delivery. Silicone free so ideal for use in paint applications. Lightweight aluminum body with a rugged, chrome-plated brass High Flow nozzle. 34 CFM @ 125 PSI, 2.1 lbs of thrust. OSHA compliant.

<u>Code</u>	<u>Description</u>	<u>List/ea</u>
2501CS-TYP	All Metal Blow Gun	\$ 70.59

### PREMIUM 600 SERIES SAFETY BLOW GUN

Coilhose Pneumatic

600P-S



A thumb-lever blowgun with a comfortable, ergonomic shape and accepts all Coilhose 1/8" tips. Conforms to OSHA standards for noise levels (1910.95) and 30 psi dead-end pressure (1910.242B). Plated finish provides easy cleaning. Tough die cast zinc body. Max Inlet Pressure: 150 psi. 1/4" NPT Inlet.

<u>Code</u>	<u>Description</u>	<u>List/ea</u>
600P-S	Safety Blow Gun	\$ 24.18

## POCKET CUTTER MACHINES

## CASTLE

### TABLE TOP POCKET CUTTER

Special Order

#### TSM12



This portable manual cycle pocket cutter was designed for fast assembly of face frames and cabinet panel construction. It offers the same drilling pattern as the larger unit (TSM22).

- Fast, hand-operated cycle; pockets can be done in less than 2 seconds
- Works well in high-pressure plastic laminate particle board, MDF, melamine and solid wood 1/2" to 1-1/2" thick
- Dust collection port openings for shop vac and 4" collection systems

#### Product Specs:

Router: Bosch 2.0hp #1617  
 Drill: Bosch Colt 1.0hp #PR20EVS  
 Router Bit: Prem 3/8" Solid Carbide, Rough Mill  
 Drill Bit: 9/64" Brad and Spur Premium TiN Coated Bit  
 Power Req: 110 VAC, 15 amps  
 Shipping Wt: 60 lbs.

### TSM12, TSM22 and TSM35

Assemble face frames and panels with less clamping and better alignment.

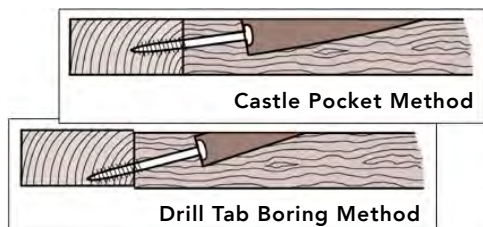

Steep screw angle contributes to joint shift

The low screw angle of the Castle Pocket method reduces screw breakout and splitting which saves sanding belts and minimizes rejects.

### AUTOMATIC POCKET CUTTER

Special Order



#### TSM22

The Castle Pocket Cutting Machine first routes a clean pocket and then drills a pilot hole from the edge to the pocket at 6°. This low screw angle produces very little shifting force, which eliminates the requirement for expensive and space consuming clamping systems. The low screw angle reduces screw breakout and splitting which saves sanding belts and minimizes rejects.

#### Features:

- 1.75 HP, 110 VAC, 15 amps, 85 PSI
- Fast - Automatic cycle adjustable to less than 2 seconds per cycle
- Safe - Will not cycle unless material is inserted completely
- Works well in high pressure plastic laminate, particle board, MDF, Melamine and solid wood 1/2" to 1-3/4" thick

Router: Bosch 2.0hp #1617  
 Router Bit: Premium 3/8" Solid Carbide, Rough Mill  
 Drill: Bosch Colt 1.0hp #PR20EVS  
 Drill Bit: 9/64" Brad and Spur Premium TiN Coated Bit  
 Power Req: 110 VAC, 15 amps  
 Air Req: 1 cfm at 85 psi  
 Shipping Wt: 180 lbs.



## CASTLE

## POCKET CUTTER MACHINES

### AUTOMATIC POCKET CUTTER - Heavy Duty Castle Tool

**TSM35**



Special Order

The Model TSM35 Heavy Duty Screw Pocket Cutting Machine has been designed for continuous operation in a heavy production environment. First it routes a clean pocket and then drills a pilot hole from the edge to the pocket at 6°. The low screw angle produces very little shifting. It also reduces screw break-out and splitting, which saves sanding belts and minimizes rejects.

**FAST** - Fast cycle time for speedy production.  
**SAFE** - Will not cycle unless material is inserted completely.

Easy top-down access for quicker router and drill bit changes. Adjustable Indexing-Stops in top for face frame parts. Side brackets allow mounting of wing tables.

- Router: 1-1/2 HP Baldor Router Motor
- Router Bit: Premium 3/8" Solid Carbide, Rough Mill
- Drill: Sioux Air Motor
- Drill Bit: 9/64" Brad and Spur Premium TiN Coated Bit
- Power Req: Three-phase 208v, 230v, 460v
- Air Req: 85 psi - External Regulator, Filter and Lubricator included
- Shipping Wt: 360 lbs.

### CASTLE TOOL ACCESSORIES

#### Pilot Hole Drill Bits

**B00764 - 7/64" Split Point:**  
Use with #7 screw for a very snug fit, requiring a driver for insertion.



List/ea \$ 18.56

**B00964 - 9/64" Brad Point:**  
The standard bit that ships with Castle Pocket Cutters. Brad point tip tracks well in all kinds of materials, suitable for the majority of pocket cutting needs. Use #7 screw.



List/ea \$ 19.05

**B01964 - 9/64" Split Point:**  
works in all materials, but is most useful when drilling along an extremely tough grain pattern. Use #7 screw.



List/ea \$ 22.61

#### **B02964 - 9/64" Premium Drill Bit:**

Titanium nitride (TiN) coated which is harder than carbide and provides greater edge retention and corrosion resistance. Ideal for hard woods. Use #7 screw.



List/ea \$ 26.28

#### **B00316 - 3/16" Drill Bit:**

Best used with a #8 screw in soft woods or materials such as melamine.



List/ea \$ 17.02

#### **B00338 - Premium Carbide Router Bit:**



List/ea \$ 118.75

Comes standard with all new Castle machines. Designed for both hard and soft woods, leaving a clean, splinter free pocket. Excellent for cutting MDF, Melamine, Laminates, and other composites. Lasts 3-5 times longer than other rough mills.

#### **B00438 - 3/8" Cobalt Bit:**



List/ea \$ 76.58

This High Speed Steel 4 flute bit works well routing most solid woods. The rough mill design routs a clean and splinter free pocket.



## COVER CAPS

### ADHESIVE-BACKED CASTLE COVER CAPS

Fastcap

Self-adhesive cover caps to cover holes cut by Castle Pocket Cutter machinery.

PVC colors or real wood veneer.  
9/16" x 2-1/2" caps, 1/32" Thick.

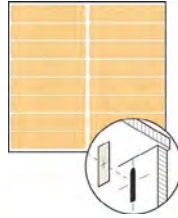

Pack: 16 caps per sheet, 320 caps per box  
Please order in increments of 16!

<u>PVC</u>	<u>Color</u>	<u>List/C</u>
FC-WH-CC	White	\$ 18.43
FC-BL-CC	Black	17.99
FC-NO-CC	Natural Oak	20.92
FC-HM-CC	Hard Rock Maple	23.06
<u>Real Wood</u>		
FC-MAP-CC	Maple	28.79
<u>Real Wood, Finished</u>		
FC-MP-CCF	Maple	39.10

## CASTLE ASSEMBLY TABLES

### AT RACE ASSEMBLY TABLES - All Special Order

The AT Race Assembly Table clamping arm glides smoothly on an open beam that allows face frames to extend beyond the top of the table. Redesigned quick-clamps feature dual handles and centered activation for easy clamping from either direction. The rigid steel arm constructed out of Unistrut stands up to years of use.

The open back table gives you more work area and can handle oversize frames without taking up valuable shop space. Available in 8 ft and 12 ft. lengths.



**AT Race 8**



**AT Race 12**



Driver sold separately on each table.

### **Features**

- Rigid steel constructed Unistrut arm with (3) quick clamps
- Sturdy 4x8 and 4x12 work surfaces
- Quick clamps have dual handles and centered activation for ambidextrous use
- Ergonomically angled workshop
- Bottom rail at 32" to reduce operator fatigue
- Additional Pressure Regulator & hose for pneumatic air driver
- Shipping weight:
  - 4x8: 490 lbs. approx.
  - 4x12: 795 lbs. approx.
- Footprint:
  - 4x8: 113" x 43" x 79"
  - 4x12: 165" x 43" x 83"

## HEAT GUN

### HEAT GUN



Perfect for stripping paint, drying finish, drying waterbase contact cement, bending plastic, activating adhesives, softening white and yellow glue joints, and many other applications. Designed and assembled in the USA.

Cord length: 6 ft, 3-wire grounded.

- Long-life universal motor delivers 2X Plus run life
- High temp and power ratings: 1200°F / 649°C
- High air flow rating: 27 CFM at 3400 FPM
- Air intake regulator allows variable temp adjustment
- Mica insulated nozzle allows cool exterior temp
- Sturdy die cast aluminum housing
- Padded, adjustable stand can be positioned for any work angle - 90°

Rating: 120V AC, 14.5 Amp  
 Watts: 1740  
 Max. Temperature: 1200 °F  
 Max. Air Volume: 27 CFM at ambient  
 Dimensions: 10" L x 5.25" W x 9.5" H  
 Weight: 3.7 lbs.

Code	Description	List/ea
HG-501D	Heat Gun	\$ 298.00

### 18V COMPACT 1/2" DRILL/DRIVER KIT with (2) 1.5 Ah SlimPack Batteries



1/2" Drill with 480 In.-lbs. of torque for more power. Two-speed transmission and 20+1 clutch settings for accurate driving. Compact design, Soft-Grip handle.



Balanced, with a short head-length and a weight of only 2.80 Lbs. + battery. Keyless 1/2" chuck, built in LED and soft-grip handle. Kit includes two 18V, 1.5 Ah SlimPack batteries, an 18V charger and a carrying bag.

Code	Description	List/ea
GSR18V-190B22	18V Drill/Driver Kit	\$ 198.33

## CORDLESS DRILLS

### BOSCH PS31-2A 12V DRILL DRIVER



Cordless

Model PS31-2A  
 Rating 12 Volt  
 No Load RPM 0-350/0-1.300  
 Max Torque 265 lbs.  
 Chuck capacity 3/8"  
 Clutch settings 20 + 1  
 Length 7"  
 Weight 2.14 lbs.



PS31-2A

- Equipped with 3/8" Single Sleeve Chuck
- LED Light - Enables use of tool in low light or dark areas
- 20 + 1 Clutch Settings - For precise torque adjustment
- Forward/Reverse Button - Equally useful at driving or removing screws
- Light weight and compact

Includes: (2) Lithium Ion 12V Max Batteries, 30 Minute Charger, Carrying Case

Code	Description	List/ea
PS31-2A	Drill Driver 12 V, 3/8"	\$ 243.65



### 2-TOOL COMBO KIT includes: 3/8" DRILL/DRIVER & IMPACT DRIVER

Includes:



- (1) PS31 12V Max 3/8" Drill/Driver
- (1) PS41 12V Impact Driver
- Lithium-Ion 2.0 Ah Batteries
- Power Drive Bits
- Charger, Carrying bag

Features:

- **PS31** - lightweight drill, high torque in a pocket size
- 1.8 lbs, 7" in length
- **PS41** - 12V Max impact driver offers the precision of variable speed, a light body, and a short head length
- 2600 RPM, 3100 BPM, 930 In.- Lbs. torque
- 2.13 lbs, 7.25" in length

Code	Description	List/ea
CLPK22-120	PS31/PS41 Driver Combo	\$ 281.67



## LAMINATE TRIMMERS

## ROUTERS

### PORTER CABLE LAMINATE TRIMMERS

#### PCE6430

Laminate Trimmer, 1/4"

- 4.6 lbs. weight
- 31000 RPM, 4.5 amp motor
- Precision-machined, cast-aluminum fixed base
- Extra large locking clips allow for a quick motor release and/or course depth adjustment
- Depth ring enables quick and accurate bit height adjustments
- Spindle lock button allows for single-wrench bit changes



PCE6430

#### Includes:

- (1) Standard fixed base
- (1) 1/4-inch collet
- (1) Collet wrench
- (1) Straight edge guide

<u>Code</u>	<u>List/ea</u>
PCE6430	\$ 238.43

#### PCE6435

Laminate Trimmer, 1/4"

- 5.2 lbs. weight
- 16000-35000 RPM, 5.6 amp motor
- Precision-machined, cast-aluminum fixed base
- Extra large locking clips allow for a quick motor release and/or course depth adjustment
- Depth ring enables quick and accurate bit height adjustments
- Spindle lock button allows for single-wrench bit changes



PCE6435

#### Includes:

- (1) Standard fixed base
- (1) 1/4-inch collet
- (1) Collet wrench
- (1) Straight edge guide

<u>Code</u>	<u>List/ea</u>
PCE6435	\$ 326.70

### BOSCH COMPACT 1.0 PALM ROUTER

Variable Speed



Powerful  
15.0- Amp Motor  
Produces 1.0-HP max.  
and 16,000-35,000 RPM

Fast and Precise Depth  
Adjustment System  
Allows both macro and  
micro adjustment

Rugged Aluminum  
Fixed Base  
Durable, solid and precise  
base for optimal movements



Compact Design  
Provides precision in  
tight spaces

Unique Finger Support  
Pockets  
For additional stability,  
especially when trimming  
edges

Versatile Bit-Changing  
System  
Fast, easy bit changes  
using two wrenches or  
spindle lock and one  
wrench

#### Includes:

- (1) PR20EVS Palm Router
- (1) PR001 Fixed Base
- (1) 1/4" Self-Releasing Collet Chuck
- (1) Shaft Wrench
- (1) Collet Wrench



#### Specifications:

Horsepower:	1.0	Fixed Base Depth	
Voltage:	120V	Range:	1-3/16"
Amp Rating:	5.6 A	Base Opening:	1-9/16"
Collet Type:	1/4" SR	Height:	7-1/2"
No load RPM:	16,000 - 35,000 RPM	Weight:	3.3 lbs.

<u>Code</u>	<u>Description</u>	<u>List/ea</u>
PR20EVS	Compact Palm Router	\$ 192.24



## BOSCH

## ROUTERS

### BOSCH VARIABLE SPEED 1.25 HP PALM ROUTER

**Includes:**

- (1) GKF125CE Colt 1.25 HP (Max) Variable-Speed Palm Router
- (1) PR101 Fixed Base
- (1) 1/4" Self-Releasing Collet Chuck
- (1) Collet Chuck Wrench



**Features:**

- Robust construction
- Powerful 1.25 HP (max), 7.0 Amp motor
- Precise depth adjustment
- Rugged 360° (non-split) aluminum base housing, accepts bits up to 1-5/16" wide
- Variable speed dial from 16,000 to 35,000 RPM

Code	Description	List/ea
GKF125CEN	1.25 HP Palm Router	\$ 266.67

### BOSCH VARIABLE SPEED 2-1/4" HP ROUTER

Model 1617EVS  
List \$ 364.47



- Exclusive Precision Centering System design; accurate, repeatable cuts at any depth setting.
- Microfine bit depth adjustment with resettable indicator ring.
- Adjustable sub-base allows precise centering for pattern work.
- Strong, lightweight all-magnesium construction.
- Precision self-extracting collet system.
- Quick templet guide change lever.

**Specifications:**

Power.....120VAC	Base (opening) 3-3/4", (dia) 6"
Horsepower.....2.25	Collet Capacity:
Motor Amps.....12	1/4", 3/8", 1/2", 8mm
No Load RPM...8,000-23,000	Weight.....8.3 lbs.

**Includes**

1/4" S. R. Collet Chuck.....	2 610 906 283
1/2" S. R. Collet Chuck.....	2 610 906 284
16mm Shaft Wrench.....	2 610 991 388
24mm Collet Nut Wrench.....	2 610 992 417
Chip Shield.....	2 610 991 389
Tool-Free Templet Guide Adapter.....	2 610 991 370

### ROUTER TEMPLATE GUIDES

Porter Cable

**Stocking guides.** Use 42024 and 42237 with Soss Hinges.



42024 - 3/4" Guide for Lock Face Routing



42045 - 5/8" Guide for Stanley T-3 Templates



42030 - 1" Guide for Tectus Templates



42237 - Lock nut for all Template Guides



42975 - 3/8" Router Collet

Code	ID	OD	Distance past base	List/ea
42024	21/32"	3/4"	9/16"	\$ 13.35
42045	17/32"	5/8"	9/16"	12.32
42030	25/32"	1"	3/8"	32.24
42237	Template guide lock nut			7.79
42975	3/8" Router Collet			23.86

**Special Order:**



42027



42033



42042

Code	Description	ID	OD	Distance past base
42027	1/2" dovetailing and general routing	11/32"	7/16"	5/32"
42033	General routing	13/32"	1/2"	5/16"
42042	Hinge Butt routing	5/8"	51/64"	9/16"



**ROUTERS**

**FESTOOL**

**OF 1010 REQ-F-PLUS ROUTER**

**Includes:** 576922

- 5/16" and 1/4" collets
- Chip catcher
- Dust extraction hood
- Guide rods/stop
- Collet wrench
- Plug-it cord
- Systainer SYS3



Versatile, precise and easy to handle. Whether used on the guide rail or off, the OF 1010 R router is the ideal tool for fine routing work. Thanks to its size and low weight, it can be accurately guided along edges, lines or curves. For routing profiles, grooves, rabbets, and dovetail joints among other applications.

Power consumption..... 1010 watts/ 8.5 amps 120 V AC  
 Drive Shaft speed..... 10,000 - 23,000 rpm  
 Routing depth adj range..... 5/16" (8mm)  
 Collet dia. range..... 1/4" and 5/16"  
 Weight..... 6.61 lbs. (3 kg)

<u>Code</u>	<u>Price</u>
576922	\$ 559

**PLUG-IT REPLACEMENT POWER CORDS**

16 and 18 gauge

- 13 feet long
- Easily replace damaged or worn cords with the plug-it system
- By using a single cord:
  - save time switching between tools
  - minimize tangles and trip hazards
- Faster and easier to store and transport



<u>Code</u>	<u>Description</u>	<u>Price</u>
203925	16 gauge cord for use on TS55/TS75 Saws, OF1010/1400/MFK Routers	\$ 55
203923	18 gauge cord for use on Jigsaws, DF500 Domino, & Sanders	53

**MFK 700 EQ EDGE ROUTER SET**

**Includes:**

- 5/16" and 1/4" collets
- Vertical Base
- 1.5° Horizontal Base
- Dust extraction hood
- Feeler Bearing Set
- Standard threaded base for U.S. Guide Bushing
- Plug-it cord
- Systainer

576239



<u>Code</u>	<u>Price</u>
576239	\$ 659

Power consumption..... 720 watts/ 6.0 amps 120 V AC  
 Drive Shaft speed..... 10,000 - 26,000 rpm  
 Column Stroke..... 9/16" (14mm)  
 Max Bit dia..... 1" (26mm)  
 Weight..... 4.41 lbs. (2 kg)

Precision and flexibility in a trim router. With its modular design and tool-less base changes, the MFK 700 can easily transform from a vertical to a horizontal position with a few simple steps.

Trim laminate and edge band or rout grooves for inlays easily with its light weight and maneuverability. Allows you to use bearing-less bits when used with the attachable base feeler bearing. 1/256" (1/10 mm) fine depth adjustments and exceptional dust extraction make this an ideal router for all of your light routing tasks. For greatest range of adjustment a 3/4" (19mm) bit diameter is recommended.

## FESTOOL

## ROUTERS

### FESTOOL OF 1400 EQ-F-Plus Plunge Router

This router gives you more power in a light package, easy operation, smooth running, more routing depth, and the ultimate in dust extraction.

2-1/4 HP in under 10 lbs, takes 1/2", 3/8", 1/4" or 8mm bits to handle almost any project.

Change bits quickly with the new ratcheting collet. The new chip catcher helps you work super clean for near-total dust extraction when used with a dust extractor. 2-3/4" routing depth precise to 1/256" (1/10 mm).



576213

<u>Code</u>	<u>Price</u>
576213	\$ 699

#### **OF 1400 Includes:**

- 8mm, 1/2", 1/4" collets
- Collet wrench
- Chip catcher
- Dust extraction hood
- Guide rods
- Standard U.S. guide bushing adaptor
- Plug-it cord
- Systainer

Power consumption..... 1400 watts/  
 11.7 amps 120 V AC  
 Drive Shaft speed..... 10,000 - 22,500 rpm  
 Quick depth adjustment range... 2-3/4" (55mm)  
 Collet dia. range..... 1/4", 1/2", 8mm  
 Weight..... 9.9 lbs. (4.5 kg)

#### **Guide Stop**

sold separately



Attaches  
 1400 router  
 to guide rail  
 system

<u>Code</u>	<u>Price</u>
492601	\$ 66

### FESTOOL OF 2200 EB-F-Plus Plunge Router

Festool's most powerful router. Plunges easily into 8/4 hardwoods and makes a 1/2" groove in a single pass. 2200 watts of power. Exceptional maneuverability.

Also features four position depth stop, double column clamping, tool-less inserts, dust extraction and magnetic brake.



<b><u>OF 2200 EB Includes:</u></b>	<u>Code</u>	<u>Price</u>
	576223	\$ 1099

- 1/2" collet
- Dust hood
- Systainer
- Chip catcher
- Collet wrench
- Standard U.S. guide bushing adapter

Power consumption..... 2200 watts/ 15 amps 120 V AC  
 Drive Shaft speed..... 10,000 - 22,000 rpm  
 Quick depth adjustment range... 3-5/32" (80mm)  
 Collet dia. range..... 1/4", 1/2", 8mm  
 Weight..... 17.2 lbs.



## CNC ROUTER



### ORIGIN Router Handheld CNC by Shaper



Shaper Origin combines computer guided accuracy with hand-held familiarity. Cut with unparalleled precision, flexibility and efficiency.

- Digital Template Library
- On-Tool Design
- Powered Plunge & Depth Stop
- Bit Diameter Compensation
- Precision Alignment
- Automatic Retract
- Revisit Past Workspaces
- On-site Modifications

- Touch screen: Capacitive multi-touch full-color LCD
- Dust extraction port: designed for the SM-1 spindle. Fits most standard 27mm & 36mm suction hoses. Includes adaptor hose.
- WiFi & USB Connectivity

#### Brushed Motor Spindle

720 Watt (AC), 10,000 - 26,000 RPM with load-compensating speed control. Soft-start, over-temperature and over-load safety cut-offs. 120 VAC (60HZ) Input Power.

#### 1/4" Collet

Ships Installed. Accepts any commonly available 1/4" shank router bits. 1/8" Collet sold separately.

#### 43mm / 1.7" Z-AXIS MAX Depth

Digitally adjustable depth-of-cut. Automated touch-off sensor.

Weight: 14.5 lbs, 11.75" Height, 7.75" Depth, 13.75" Width

#### Included in the box:

- (1) SO1-NN Origin router
- (2) ST1-150 Shaper Tape Rolls
- (1) 4mm T-Hex Wrench for Spindle removal
- (3) Cutters: 1/8" Up-spiral bit  
1/4" Up-spiral bit  
V60° Engraving bit
- (1) 19mm Wrench
- (1) Adapter hose, 6.5' L, 2.25" OD nozzle

## Shaper Workstation

SW1-AA \$ 450



#### Components

**Body:** The core of Workstation with durable ShaperTape pre-applied and multiple ways to secure to your bench.

**Clamping face:** Versatile clamping platform factory calibrated to guarantee precision alignment every time.

**Support bar:** An adjustable support for the front edge of Origin, designed to keep your cuts flat and precise.

**Support arms:** Arms that hold the Support Bar in line with the body.

**Shelf:** Height adjustable surface for fixturing small or difficult-to-hold work pieces of almost any thickness.

**Angle fence:** Adjustable angle guide with a built-in scale makes it easy to set up and cut angled tenons between 0° and 45°.

**4mm Wrench:** T-handle Hex wrench

**Hold Down Clamps:** T-Track Clamps for versatile and secure fixturing.

**Spoilboards:** Sacrificial MDF used to minimize tear out when cutting.

- Highly Versatile Fixturing
- Accurate Mortise & Tenons
- Difficult workpieces made easy
- Quick setup features make repetitive cuts for volume production fast and reliable



#### Shaper Hub

Scan or visit [hub.shapertools.com](http://hub.shapertools.com) for Origin-Ready Projects and Files.

- Get Hardware Templates
- Build Premium Projects
- Find & Publish Projects

**SHAPER ORIGIN Router Accessories**

**CNC ROUTER**

**Shaper Tape**

- 150 feet /roll
- Allows Origin to locate itself on any workpiece
- Adheres to a variety of materials and removes without leaving residue

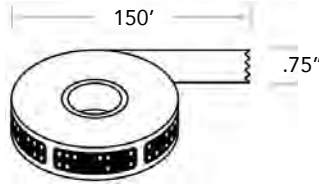

**ST1-150 \$ 18/ ea**

**1/8" Collet w/ Nut**

- Accepts specialty bits with 1/8" shanks
- Great for fine engraving and inlay work



**SC1-1250 \$ 46/ ea**

**Up-Spiral Bits**



**SE1-2500-1250U**  
 Great for intricate cuts and finer details.  
 1/8" x 1/2" List \$ 23



**SE1-2500-2500U**  
 Ideal for composite materials, hardwoods, and softwoods  
 1/4" x 3/4" List \$ 22

**Engraving Bit**



**SE1-2500-V60E List \$ 18**

- Ideal for engraving a wide variety of materials
- 60° cutting angle for shallow v-cuts
- 1/4" shank fits Origin's stock collet

**3 Piece Essential Bit Kit SG2-3E1 List \$ 90**



Bit Kit includes:

- (1) 1/4" carbide upcut cutter
- (1) 1/8" carbide upcut cutter
- (1) 60° carbide engraving bit

**5 Piece Collet Kit**

**SG1-5CD \$ 180/ ea**



The complete collet kit includes:

- 3mm collet
- 6mm collet
- 8mm collet
- 1/8" collet
- 1/4" collet

**Shaper Systainer SYS1 - Customizable**

- Modular design stacks with other Systainers
- Made of durable, robust, high quality ABS
- Customizable solid foam insert which can be cut with Origin



**SH1-SS1 List \$ 90**

**Shaper Pro Support for the Origin CNC**



**SP1-D1 List \$ 600**

Shaper Pro is designed with the professional user in mind. Get the most out of your Shaper Origin with Shaper Pro's Enhanced support, an extended warranty, and hot swap repairs which reduce the possibility of project delays and help you meet your deadlines.



# CNC ROUTER



## ORIGIN CNC Router Universal Template

A universal template designed to install a wide range of hardware, inlay bow ties, round corners, route system 32 holes and so much more. Align Plate to your workpiece and let Origin do the rest. Utilize hundreds of digital files available on ShaperHub.

Plate dimensions: 14.25" W x 17.7" H x .25" thick.  
Cut window: 6.29" W x 4.72" H. Weight: 4.5 lbs.

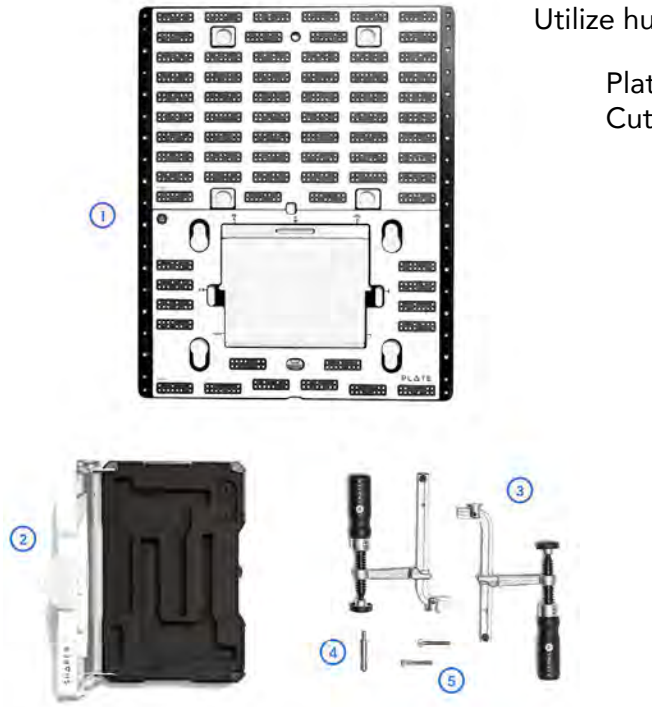

- 1) **Plate:** The universal template and fixture for Origin
- 2) **Mini-Systainer:** Custom systainer designed for Plate. Interlocking T-LOC system
- 3) **Low Profile Clamps:** Non-marking head, 60mm throat. Use the clamps to secure Plate to your workpiece.
- 4) **System 32 Pin:** Accurate 32mm spacing
- 5) **Leveling Feet:** Support the corners of Plate when necessary



### Fence

Quickly align Plate to the front edge of your workpiece using the Fence.



### Low Profile Clamps

Maximize your cutting space with Low-Profile Clamps for fixturing.



### Reticle

Use Plate's Reticle to align with a mark anywhere on your workpiece's surface.



### Mortise Door Hinges

Plate's threaded rails make it easy to use with custom fixtures, like this door mortising jig



### Flag Alignment

Align Plate along the side or edge for maximum flexibility or when radiusing a corner.

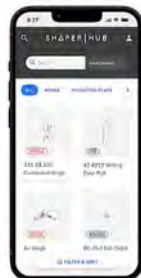

Code  
SV1-AA

Description  
Shaper Plate, Universal Template

List/ea  
\$ 375



### Shaper Hub

Scan or visit [hub.shapertools.com](http://hub.shapertools.com) for Origin-Ready Projects and Files.

- Get Hardware Templates
- Build Premium Projects
- Find & Publish Projects

## FESTOOL ACCESSORIES

### HOLE DRILLING SET, LR 32-SYS

For use with OF 1010 & OF 1400 Festool Routers

**584100**

Drills 32mm System holes  
 & 35mm hinges holes



<u>Code</u>	<u>Price</u>
584100	\$ 595

Precisely and efficiently build cabinets using the European frameless 32mm system. Invaluable for placing cup hinges (35mm) or setting shelf pin holes (based on 32mm spacing) in casework, this portable line boring system allows you to do in the field what has traditionally been a shop-only job, possible only with large stationary equipment. For use with the Festool OF 1010 and OF 1400 routers and guide rail system, the LR 32 System is supported by a 42", 55" and a 95" rail (sold separately), to cover any size job.

**Includes:** Guide plate, Centering mandrel, 2 edge stops, 2 linear stops, 2 clamps, Operating wrench, 35 mm carbide-tipped European hinge boring bit, 2 carbide-tipped 5 mm shelf pin bits (one for through holes and one for stopped pin holes).

### GUIDE RAIL, 55" W/ 32mm HOLES

For use with 584100 Hole Drilling System

Combine this guide rail with the Festool LR 32 Hole Drilling System (#584100) to efficiently build European style 32mm cabinets. Quickly and easily align and machine holes for shelf pins and 35mm cup hinges.



496939

<u>Code</u>	<u>Price</u>
496939	\$ 165

Use your Festool routers, plunge saws, or jigsaws with the guide rail for expanded capability. Guide strip reduces friction between the tool and guide rail for easier, more fluid cutting action.

## LOCK MORTISER



### LOCK MORTISER

**Special Order**

Model 513\*

List \$ 2435



- 11 Amps, AC only
- 1-3/4 HP, 27,500 RPM
- Quick, accurate cutting of mortises for box locks
- Cuts mortises up to 7" long, 1-1/4" wide, 4-3/4" deep
- Automatically centers cutter on door edge
- Mounts to door in seconds
- Adjustable height rod for repetitive mortise cuts
- Includes height rod, 3/4" & 1" mortising bits, wrench set, and operating manual

### LOCK FACE TEMPLET

**Special Order**

Model 517\*

List \$ 525

Used to quickly rout lock faces on door after the mortise for the box lock itself has been completed. Automatically self-centering and self-beveling. Includes: Templet, 42024 Templet Guide and operating manual. Net Wt. 2-1/2 lbs. (Max Mortise 1-1/2" x 8-1/2")



### CORNER CHISEL

Model 42234

List \$ 40.76



Square the corners with Porter-Cable's No. 42234 Corner Chisel, and your door is ready to accept your lock face.



## EDGEBANDER

## FESTOOL

### Hand Held Edge Bander CONTURO KA 65

With the new CONTURO Edge Bander, it's just as easy to apply edge banding on the job site as it is in the shop. Even if you have a large stationary edge banding machine, the CONTURO can complement your edge banding process by giving you a way to work with radii, circular pieces, bevels and small pieces.



#576577  
Hand Held  
Edgebander  
\$ 3299

Offers exceptional ergonomic design, including dual speeds, and a unique patented hot melt glue adhesive system. There's no risk of burns because the glue system is thermally isolated.

- Capable of edge banding curves, circles, convex and concave radii and inside corners
- Electronically controlled precision glue distribution system for maximum adhesion
- Compact, portable, ergonomic design for easy use and flexibility
- Optional table mounting for working with small work pieces

**Includes:**

- Natural EVA Adhesive, 4-Pack
- Support handle / guide table
- Systainer SYS3

**Specifications:**

Inner Radius Minimum of 2" (50mm)  
Max. Banding Height: 23/32" to 2-9/16" (18-65mm)  
Max. Banding Thickness: 1/32" to 1/8" (0.5-3.0mm)  
Weight: 17.4 lbs (7.9 kg.)



### Natural EVA Edge Banding Adhesive 48 pack / For above Edge Bander



#499812  
Natural Color

EVA edge banding adhesive. Available in natural (for natural wood edge banding), white (for most light colors of edge banding), brown and black (for most dark colors of edge banding).

Pack: 48 pcs.

Code	Color	List/bx
499812	Natural	\$ 159
499813	White	159
200059	Brown	159
200060	Black	159

### MFT/3 CONTURO Edge Bander Table Set Combine with above Edge Bander

#500869    **\$ 889**  
Conturo Edge Bander Table  
Set includes:

- Table insert
- Table adapter
- Guide plates
- Cross members

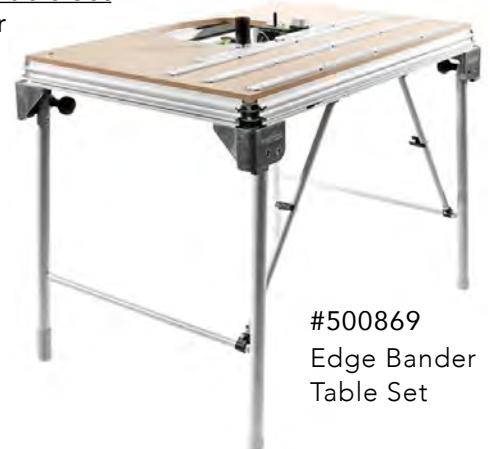

#500869  
Edge Bander  
Table Set

Combine the CONTURO Edge Bander with the Festool MFT/3 Work Table to process small work pieces and to edge band bevels. Edge bender can be quickly inserted and removed from the work table without any tools. The mounting bracket has preset detents for common angles.

Equipped with the Table Insert, Table Adapter, Guide Plates, and Cross Members, the MFT/3 CONTURO provides even more options for successful edge banding projects. Perfect for working with small pieces that would otherwise be difficult to work on with the CONTURO as a handheld machine.

## FESTOOL

## DUST EXTRACTORS

### EDGE TRIMMING SET KB-KA 65

Accessories Kit for Conturo Edge Bander

<u>Code</u>	<u>Price</u>
500177	\$ 515



The Edge Trimming Kit is a collection of accessories for the CONTURO Edge Bander (576577) and other components to help you achieve the perfect edge.

**Includes:** Edge Banding Reel, Additional Roller, Edge Banding Trimmer, Scraper, StickFix Base Kit with 3x Felt Pad, 5x Polishing Felt, 20x Abrasive Sheets Stick-Fix Brilliant 2 80 x 133 P320, Hand-Sanding Block 80 x 133 mm, 5x StickFix Sanding Cloth S 800, MPA 6000 Polishing Compound in a Systainer SYS 4 T-LOC.

### ADAPTER BASE FOR KA 65

For using the edgebander KA 65 as a bench-mounted machine. Adapter plate for installation in the MFT (with perforated board KA 65, order no. 500366) or a separate workbench. Includes guide plates.



<u>Code</u>	<u>Price</u>
500175	\$ 509

### GUIDE PLATES

Guide Plates for KA 65 Table Insert (500366). Provides low friction surface area for stationary edge banding application.



15 each per pack, sold per pack.	<u>Code</u>	<u>Price</u>
	500367	\$ 30

### Dust Extractor CT 48 HEPA

For non-hazardous dusts



#### **CT 48 E Includes:**

- HEPA filter
- 1 fitted, Selfclean filter bag
- 1 antistatic suction hose, 1-1/6" x 11.5 ft. (27mm x 3.5m)
- 1 cable holder

<u>Code</u>	<u>Price</u>
577085	\$ 935

Container/Filter bag cap..... 12.7/12.2 gal.  
 Depth x Width x Height.....29" x 16" x 40"  
 Weight..... 35.7 lbs.  
 Noise Level..... 62-71 dB (A)  
 Power Consumption..... 350-1200 watts/  
 2.9-10 amps 120V  
 ACMax Suction Capacity.....137 CFM  
 Max Vacuum..... 96" static water lift

Ideal for the workshop and provides maximum volume thanks to its large capacity. Highly mobile due to its swiveling castor wheels, rear wheels and handle. Includes a locking brake that provides stability on any surface as well as during transport.



- Large capacity for large volumes of dust and coarse chips
- Can be individually retrofitted with an additional compressed air or Bluetooth® module for remote control on the suction hose or automatic start via the Bluetooth® battery pack.
- Smooth suction hose and optimized SYS-Dock with cord holder and T-LOC function for conveniently connecting Systainers to the mobile dust extractor
- Antistatic function
- Attachment of Systainers via SYS-Dock





## DUST EXTRACTORS

## FESTOOL

### Dust Extractor CT 36 HEPA

For non-hazardous dusts

- **9.5 gal.** (36 L) capacity
- Can be retrofitted with Bluetooth® module for remote control on the suction hose or automatic start via the Bluetooth® battery pack
- Larger wheels provide stability and ease of movement
- Large flat area for tools or stacking
- Tool triggered or manual on-off switch with smooth start-up and shut-off delay
- Stepless electronic suction control
- Wet and dry extraction with no complicated conversion



577084

- Integrated cleaning device cleans the filter in the blink of an eye
- Blower port
- Standard antistatic equipment protects against electrostatic charging

### CT 36 E Includes:

- HEPA filter
  - 1 fitted, Selfclean filter bag
  - 1 antistatic suction hose, 1-1/6" x 11.5 ft. (27mm x 3.5m)
  - 1 cable holder
- |  | Code   | Price  |
|--|--------|--------|
|  | 577084 | \$ 865 |

Container/Filter bag cap.....	9.5/9 gal.
Depth x Width x Height.....	25" x 14.4" x 23.4"
Weight.....	31.8 lbs.
Noise Level.....	62-71 dB (A)
Power Consumption.....	350-1200 watts/ 2.9-10 amps 120V AC
Max Suction Capacity.....	138 CFM
Max Vacuum.....	96" static water lift

### Dust Extractor CT 26 HEPA

For non-hazardous dusts

- **6.9 gal.** (26 L) capacity
- Can be retrofitted with Bluetooth® module for remote control on the suction hose or automatic start via the Bluetooth® battery pack
- Larger wheels provide stability and ease of movement
- Large flat area for tools or stacking
- Tool triggered or manual on-off switch with smooth start-up and shut-off delay
- Stepless electronic suction control
- Wet and dry extraction with no complicated conversion



577083

- Integrated cleaning device cleans the filter in the blink of an eye
- Blower port
- Standard antistatic equipment protects against electrostatic charging

### CT 26 E Includes:

- HEPA filter
  - 1 fitted, Selfclean filter bag
  - 1 antistatic suction hose, 1-1/16" x 11.5 ft. (27mm x 3.5m)
  - Cable and hose holder
- |  | Code   | Price  |
|--|--------|--------|
|  | 577083 | \$ 799 |

Container/Filter bag cap.....	6.9/6.3 gal.
Depth x Width x Height.....	25" x 14" x 22"
Weight.....	30.64 lbs.
Noise Level.....	62-71 dB (A)
Power Consumption.....	350-1200 watts/ 2.9-10 amps 120V AC
Max Suction Capacity.....	138 CFM
Max Vacuum.....	96" static water lift

### Dust Extractor CT MIDI-I HEPA

For non-hazardous dusts

- **4 gal.** (15 L) capacity
- Start and stop remotely with use of the integrated Bluetooth® technology
- Larger wheels provide stability and ease of movement
- Large flat area for tools or Systainer stacking
- Tool triggered or manual on-off switch with smooth start-up and shut-off delay
- Stepless electronic suction control
- Wet and dry extraction with no complicated conversion



574837

- Integrated cleaning device cleans the filter in the blink of an eye
- Blower port
- Standard antistatic equipment protects against electrostatic charging

### CT MIDI-I Includes:

- HEPA filter
  - 1 fitted, filter bag
  - 1 antistatic suction hose, 1-1/16" x 11.5 ft. (27mm x 3.5m)
  - 1 cable holder
- |  | Code   | Price  |
|--|--------|--------|
|  | 574837 | \$ 679 |

Container/Filter bag cap.....	4.0/3.3 gal.
Depth x Width x Height.....	18.5" x 12-9/16" x 19.5"
Weight.....	24.91 lbs.
Noise Level.....	62-72 dB (A)
Power Consumption.....	400-1200 watts/ 3.3-10 amps 120V AC
Max Suction Capacity.....	130 CFM
Max Vacuum.....	96" static water lift



## FESTOOL

## DUST EXTRACTORS

### Dust Extractor CLEANTEC CT 15E HEPA

Cleans construction sites, production shops and home workshops. With a 3.96 gallon (15 L) container volume, it extracts dust, dirt, and water. Its design ensures that almost the entire container volume can be used – for long periods of work without having to change the filter bag. Full unit **HEPA Certified**, adjustable high performance turbine.

- Compact design for easy transport
- Touch operation for intuitive control
- Accessible main filter for easy replacement
- Cleaning accessories among items included and stored in the mobile dust extractor
- Flat storage area – ideal for storing consumables
- Elastic tie-down strap included to secure vacuum hose on top of CT for convenient transport
- Container/filter bag capacity 3.96/3.3 gallons (15 l)



577413

#### **CT 15E HEPA Includes:**

- 1 fitted, filter bag
- 1 suction hose, 27/32" x 11.5 ft.
- Crevice Nozzle, D36

Code	Price
577413	\$ 419

Container/Filter bag cap.....	3.96/3.3 gal.
Dimensions (LxWxH).....	18.5"x 12-9/16" x 17-1/8"
Power Cable.....	16.4' (5m)
Weight.....	24.69 lbs.
Max Suction Capacity.....	130 CFM
Max Vacuum.....	96" static water lift

### CT SYS Dust Extractor

Portable and compact

Self-contained hose and cord storage, onboard tools, manual and automatic function, shoulder strap, anti-static design, system integration, and low sound (67 dB(A)), the CT SYS is well-equipped and built for professional use.

- Full Unit HEPA
- Tool-triggered operation
- High-performance suction
- Systainer integration.

575280



#### **CT SYS Includes:**

- HEPA filter
- 1 Disposable filter bag (container/bag capacity: 1.2 gal / .9 gal)
- 1 antistatic suction hose, 1-1/16" x 9.8 ft.
- Upholstery Brush
- Crevice Nozzle, D36
- Convenient shoulder strap
- Hose holder
- SYS Dock with T-Loc function



Code	Price
575280	\$ 400



Standard Filter Bag #500438 \$ 25

Captures and contains dust and debris for easy and clean disposal. Compatible with the CT SYS mobile dust extractor.



LongLife Filter Bag #500642 \$ 96

Re-usable heavy-duty Filter Bag with integrated cap. Designed for easy and fast debris disposal. Compatible with the CT SYS mobile dust extractor.

Container/Filter bag cap.....	1.2/0.9 gal.
Dimensions (LxWxH).....	15.6" x 11.6" x 10.6"
Power Cable.....	16.5' (5m)
Weight.....	15.21 lbs.
Max Suction Capacity.....	106 CFM
Max Vacuum.....	80" static water lift

## DUST EXTRACTORS

## FESTOOL

### ACCESSORIES FOR CT SERIES DUST EXTRACTORS

#### Hose Garages

For CT26/36/48 Models

Provides a convenient way to keep your suction hose at hand and offers protections for your hose and cord during transport and storage.



Code	Description	Price
204040	Hose Garage for CT26/36/48	\$ 61.20

#### Replacement Filter Bags

Contains 5 bags/box, sold per box.



204308



452970  
452971

Code	Description	Price/bx
452970	For CT 22	\$ 46
452971	For CT 33	53
204308	For CT MIDI-2/CT15	39

#### Self-Cleaning Filter Bags

Contains 5 bags/box, Sold per box.



Code	Description	Price/bx
498411	For CT MIDI	\$ 42
496187	For CT 26 E	46
496186	For CT 36 E	53
497539	For CT 48 E	59

#### Hepa Filters

Designed to trap particles down to .3 microns while maintaining airflow, allowing you to reach full capacity without clogging or caking.



205412  
Main Filter  
CT 26/36/48



456790  
Main Filter  
CT MINI/MIDI

Code	Description	Price/bx
205412	For CT 26/ 36/ 48	\$ 115
456790	For CT MINI/ MIDI	35

#### Compact Cleaning Set

Rigid, light weight, crack-resistant polypropylene tubes and nozzles won't ding or mar floors, walls, or furniture.



**Includes:** curved hand tube, 3 extension tubes, floor nozzle, crevice nozzle, and upholstery nozzle. Packed in a durable Systainer 1.

Code	Description	Price
577257	Compact Cleaning Set	\$ 115

#### ANTI-STATIC HOSES W/ SLEEVES



201761



201778

Equipped with an integrated Plug-It Cord and sleeve, this tapered hose works well with the ETS EC sanders and others. Sleeve helps prevent the rib of the hose from catching on materials which may damage the surface and allows easy navigation over edges of work tables for better work flow while sanding. Available in two lengths: 5m (16.4') or 10m (32.8').

Code	Description	Price
201761	Hose w/ sleeve, 5m	\$ 309
201778	Hose w/ sleeve, 10m	415

#### PLUG-IT REPLACEMENT POWER CORDS

16 and 18 gauge

- Easily replace damaged or worn cords with the plug-it system
- By using a single cord:
  - save time switching between tools
  - minimize tangles and trip hazards



13 feet

Code	Description	Price
203925	16 ga, for use on TS Plunge Cut saws, OF 1010 and OF 1400 Routers	\$ 55
203923	18 ga, cord for use on jigsaws, MFK 700 router, DOMINO joiner, and sanders	53



## FESTOOL

## JIGSAWS

### PS 300 EQ Jigsaw

### PSB 300 EQ Jigsaw

Adjustable carbide-tipped jaws provide three-way blade guidance to ensure that the blade is perpendicular to the table at all times, even in curves. A splinter guard protects against chipping, leaving you with a clean, precise cut through the entire depth of the work piece, with little or no finishing.



**PS 300 EQ / 576039**

Barrel Grip fits your hand and provides a low center of gravity.



**PSB 300 EQ / 576049**

D-Handle features a fingertip trigger and smaller profile grip.

Power Consumption.....	720 watts / 6 amps 120 V AC
Stroke Rate (1").....	1000 - 2900 spm
Stroke Adjustment.....	4 Stages
Bevel Adjustment.....	0° - 45°
Cutting Depth, Wood.....	4-3/4" (120mm)
Cutting Depth, Non-Ferrous Metals.....	3/4" (20mm)
Cutting Depth, Steel.....	3/8" (10mm)
Weight.....	PS 300: 5.06 lbs. PSB 300: 5.29 lbs.

### Jigsaws Include:

- T-Shank Jigsaw Blades for wood (2 pieces)
- Chip guard
- Splinter guard
- Plug-it cord
- In Systerainer 3

	<u>Code</u>	<u>Jigsaw</u>	<u>Price</u>
	576039	PS 300 EQ	\$ 315
	576049	PSB 300 EQ	315

### Jigsaw Carvex PSB 420 EBO Plus



576192

Power Consumption.....	720 watts / 6 amps 120 V AC
Cutting Depth, Wood.....	4-3/4" (120mm)
Cutting Depth, Non-Ferrous Metals.....	3/4" (20mm)
Cutting Depth, Steel.....	3/8" (10mm)
Weight.....	5.29 lbs.

- Variable speed blade speed with extremely fast max 3,800 strokes per minute
- Tool-free base and base insert platform for expanded capabilities
- Triple blade guidance for perfectly perpendicular cuts and splinterguards for tear-free cuts
- High-intensity LEDs for high blade visibility
- Brushless motor technology for light weight, more power and longer service life

### Jigsaws Include:

- T-Shank Jigsaw Blades for wood (2 pieces)
- Splinter guard
- Plug-it cord
- In Systerainer 3

	<u>Code</u>	<u>Jigsaw</u>	<u>Price</u>
	576192	PSB 420 EBO plus	\$ 445

### Accessory Kit for Carvex Jigsaws

Keep the full system of bases on hand and ready for use. The best value for purchasing all of the accessories available for the CARVEX jigsaw. Organized in SYS 2 T-LOC Systerainer.

### Includes:

- Jigsaw Splinterguard, 5-Pack
- Steel base insert
- Angle base
- StickFix baseplate
- Guide Rail Base
- Dimpled base insert
- Circle cutter
- Hard fiber base insert
- StickFix felt



	<u>Code</u>	<u>Price</u>
	201186	\$ 250

## JIGSAWS

### FESTOOL JIGSAW BLADES

Cuts through Softwood/Hardwood, Melamine/Veneered Plywood, and chipboard. 5 blades per pack.



Blade type: S75/4 FSG, Cut type: Fast, perpendicular. Mat. Thickness: up to 1-3/16", Length: 3", TPI: 6-7.

	<u>Code</u>	<u>Price/pk</u>
	204316	\$ 19

Blade type: S105/4 FSG, Cut type: Fast, perpendicular. Mat. Thickness: up to 3-3/8", Length: 4-1/8", TPI: 6-7.

	<u>Code</u>	<u>Price/pk</u>
	204327	24

Blade type: S75/4 K/5, Cut type: Fast, for curves. Mat. Thickness: up to 1-3/16", Length: 3", TPI: 6-7.

	<u>Code</u>	<u>Price/pk</u>
	204265	\$ 17

Blade type: S75/1,4 K/5, Cut type: Conically ground teeth for clean, cut curves. Mat. Thickness: up to 1-3/16", Length: 3", TPI: 18.

	<u>Code</u>	<u>Price/pk</u>
	204267	\$ 17

### Splinter Guard

Solid one-piece Splinterguard slides easily into place for a custom fit with any blade, virtually eliminating tearout and time-consuming rework. Fits all Festool Trion and Carvex Jigsaws.



<u>Code</u>	<u>Price</u>	5 per pack
490120	\$ 13	

### BOSCH JS470E JIGSAW



Model JS470E  
 List \$ 303

#### Features

- 7-Amp motor plus speed control dial provides power and control for cutting through tough material
- Tool-less blade change system, fast insertion, blade ejection lever eliminates need to touch hot blade
- Four orbital-action settings provide different blade strokes for smooth to aggressive cuts
- Accelerator trigger controls operating speed
- Large, sturdy die-cast foot with steel insert and on-board bevel wrench, secure clamping system
- Precision-machined plunging system and low-vibration design enhances accuracy

Includes: Jig Saw, 1 no-mar overshoe, 1 anti-splinter insert, blade, bevel wrench and carrying case.

#### Specifications:

Dimensions: 15" depth, 13.5" width, 4.5" height  
 Weight: 10.38 lbs.  
 Amperage: 7  
 Bevel capacity: 45  
 Strokes per min: 3100  
 Length of stroke: 1"  
 Dust blower: Yes  
 Corded  
 UL Listed

## JIGSAW BLADES



### LENOX TOP QUALITY JIG SAW BLADES

Bi-Metal  
 Jigsaw Blade



Lenox bi-metal Bosch-style jig saw blades out-perform and out-last anything else available today, including high-speed steel, conventional steel, and other bi-metal blades.

These blades possess far superior heat and wear resistance and produce a very smooth and clean finished cut. Each blade outlasts up to 5 ordinary blades, and is virtually unbreakable. Made in U.S.A.

The initial cost of the Lenox blades is more than carbon blades, but because they last so long, these blades are substantially more cost-effective than other blades.

Pack: 2 each per pack. Full packs only.

Code	Application	Teeth Per Inch	List Per Pack
BT450S	Wood, Very Smooth	10	\$ 19.27
BT450SR	Wood, Down Cutting, Plastic Laminates, Reverse Tooth	10	18.35

Bulk	Description	List/Ctn
B450S-25	450S Bulk 25 ea/Ctn.	\$ 75.85



### Blade Comparison Chart

Lenox #	Bosch =	Lenox	Bosch =
BT450S	T101B	BT450SR	T101BR



### BOSCH JIG SAW BLADES



For Wood, Compositions, and Plastics: All 5 each/card.

Blade Reference	Part # / 5 blades/cd	Cutting Length	Teeth/ Inch	List/cd
	T101B	2-1/2"	10	\$ 11.24
	T111C	2-1/2"	8	7.43
	T119BO	1-7/8"	12	8.70
	T144D	2-1/2"	6	11.09
	T101BR	4"	10	16.43
	T101D	4"	6	12.24
	T101AO	3-1/4"	20	13.50

For Metal, Fiberglass, and Plastics: All 5 each/card.

	T101A	2-1/2"	12	\$ 17.70
	T218A	3"	24	11.35

### BOSCH BULK JIG SAW BLADES

Code	Description	List/pk
T101B-100	T101B-100 pack	\$ 170.02
T101BR-100	T101BR-100 pack	176.56
T101D-100	T101D-100 pack	163.48

### BOSCH T500 ASSORTMENT PACK



Contains one each of the following jigsaw blades:

T101B, T144D, T119BO, T118A, T118B  
 (T118A is 3" cutting length, 24 teeth/inch for cutting metal 1/16"-1/8". T118B is 3" cutting length, 14 teeth/inch for metal 1/8"-1/4")

Code	Description	List/Pk
T500	Asst. 5 blades	\$ 10.44

## JIG SAW BLADES

### BOSCH "PROGRESSOR" JIG SAW BLADES

For use in all types of materials including metal and wood. The variable tooth pitch (small teeth near shank, larger teeth at the end of the blade), ensures fast cutting and long service life.

#### T123X



Best suited for metal. Also use on plastic up to 1-3/16" and wood up to 2-5/16" thick.

#### T345XF



A universal blade for use on non-ferrous metals, plastics and aluminum profiles up to 15/16", wood with nails up to 3-1/8" and steel.

#### T234X



For solid wood or laminated chipboard. Provides accurate and splinter free cuts with clean edges. Special tip for easy plunge cuts.

Pack: 5 each per card

Code	Application	Length	List/card
T123X	Metal	4-1/2"	\$ 12.89
T345XF	Universal	5"	20.00
T234X	Wood	4"	15.84

## FESTOOL SAWS

### TSC 55 KEBI F-PLUS FS Cordless Track Saw



**TSC 55 Saw w/Rail**  
 577008

**MFT/3  
 Multifunction  
 Table**  
 500608

Includes 576718 Track Saw plus 55" Guide Rail. The kickback is the most common cause of serious injuries when using a track saw. A unique kickback stop therefore stops the saw blade of this cordless track saw in the blink of an eye, and so not only protects your workpiece but also helps to minimize the risk of injury to your hands.

Allows users to make powerful, precise cuts at up to twice the speed with an extended battery range. Brushless EC-TEC motor combined with lithium-ion batteries for maximum cutting power. Low-dust mobile working thanks to dust collection bag or an extractor with Bluetooth automatic switch-on. The kickback stop can be deactivated for individual cuts.

#### Saw Includes:



- 2x Battery pack
- 1x Rapid Charger
- 55" Guide Rail
- Chip collection bag
- WAF 5 fine tooth saw blade W42
- Sight window
- Systainer SYS 3

Battery voltage..... 18/36 V  
 Saw blade speed..... 1350 - 3550 rpm  
 Saw blade diameter..... 6-1/4" (160mm)  
 Angular range..... -1° - 47°  
 Cutting depth at 45°..... 1-11/16" (43mm)  
 Cutting depth..... 0" - 2-1/8" (0 - 55mm)  
 Dust extraction connection dia..... 1-1/16"/1-7/16" (27/36mm)  
 Weight..... 10.14 lbs. (4.6 kg)

Code		Price
577008	Saw	\$ 879
500608	Table	699

## FESTOOL

## SAWS, GUIDE RAILS

### TS 55 REQ Plunge Cut Track Saw

Incredibly portable, precise and easy-to-use, the TS 55 REQ is at home in the shop and on the worksite. With micro-adjustable depth controls and a flat housing for cutting against flush surfaces it will give a perfect cut the first time, every time, with laser-straight, splinter free cuts.



Power consumption.....	1200 watts/ 10 amps 120 V AC
Saw blade speed.....	2000 - 5200 rpm
Saw blade diameter.....	6-1/4" (160mm)
Bevel cuts.....	-1° - 47° (positive stops at 0° & 45°)
Cutting depth at 45°.....	1-11/16" (43mm) at 45°
Cutting depth.....	0" - 2-1/8" (0 - 55mm)
Arbor size.....	.787" (20mm)
Weight.....	9.92 lbs. (4.5 kg)

**TS 55 REQ Saw**  
 577014  
**MFT/3 Multifunction Table**  
 500608

#### Saw Includes:

- 1 48-tooth carbide blade
- 55" (1400mm) guide rail
- Splinter guard
- Plug-it cord
- In Systainer SYS3

	<u>Code</u>	<u>Price</u>
577014 Saw		\$ 699
500608 Table		699

### TS 75 EQ Plunge Cut Track Saw

Has a multitude of uses, from fine cabinetry to cutting spiral staircase steps; from truing rough lumber to cutting out window frames in renovation work. The TS 75 is a larger saw with more power and greater cutting depth than the TS 55.



Power consumption.....	1600 watts/ 13 amps 120 V AC
Saw blade speed.....	1350 - 3550 rpm
Saw blade diameter.....	8-1/4" (210mm)
Bevel cuts.....	0° - 47° (positive stops at 0° & 45°)
Cutting depth at 45°.....	2-1/8" (55mm)
Cutting depth.....	0" - 3" (0 - 75mm)
Arbor size.....	1.101" (30mm)
Weight.....	13.6 lbs. (6.2 kg)

**TS 75 EQ Saw**  
 576118  
**MFT/3 Multifunction Table**  
 500608

#### Saw Includes:

- 1 36-tooth carbide blade
- Splinter guard
- Plug-it cord
- In Systainer SYS5

	<u>Code</u>	<u>Price</u>
576118 Saw		\$ 799
500608 Table		699

### The FS/2 Guide Rail



Lay the guide rail on the workpiece and align the splinter guard flush with the scribe line. Place your Festool circular saw on the guide rail. The guide rib on the rail engages the guide slot on the tool, ensuring precision cutting every time. Save time and money by eliminating laborious measurements, rework and wasted material.

The Festool guide system is also an ideal solution for routing work at an angle or on the edge of workpieces. The guide cannot slip if secured with clamps. This prevents reworking and spoiled workpieces.

### FS/2 Guide Rails



- Make precision cuts
- Hard-anodized surface
- Soft, non-slip coating
- Hard rubber splinter guard

<u>Code</u>	<u>Description</u>	<u>Price</u>
491498	FS 1400/2 - 55" Length (1400mm)	\$ 155
491503	FS 1900/2 - 75" Length (1900mm)	245
491937	FS 2700/2 - 106" Length (2700mm)	465

### Guide Rail Accessory Kit



#### Includes:

- Angle unit
- Return/limit stop
- Extra splinterguard
- In Systainer 1
- Deflector
- 2 screw clamps
- 2 connectors

<u>Code</u>	<u>Price</u>
497657	\$ 250





## PLUNGE SAWS

## FESTOOL

## SAW TABLES

### Guide Rail Accessories cont.

#### Quick Clamp



Easily locked and quickly released. For use with MF Table and Guide Rails. Fits seamlessly into the bottom T-slot of guide rails for limitless positioning and secure cutting.

<u>Code</u>	<u>Ctn</u>	<u>Price</u>
491594	1	\$ 48

#### Splinterguard (Replacement)



Adhesive backed Splinterguard to maintain splinter-free cut quality. Semi-transparent for better visibility of the cut line and is quick and easy to replace.

<u>Code</u>	<u>Length</u>	<u>Price</u>
495207	55"	\$ 27
495209	197"	50

#### Connector

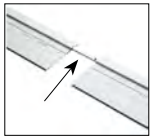

Connects two guide rails for long workpieces. Slide into the T-slot grooves in the rails. With 2 adjustable set screws per end for a secure connection. Sold per piece; 2 are needed.

<u>Code</u>	<u>Ctn</u>	<u>Price</u>
482107	1	\$ 20

#### Splinterguard (For TS 75 EQ only)



Achieve splinterfree cuts on both sides of the blade by using the off-cut side splinterguard in conjunction with the integrated guide rail splinterguard. For best results, replace when switching between different kerf blades.

<u>Code</u>	<u>Pack</u>	<u>Price/pk</u>
491473	5	\$ 28

#### Totebag for Festool Guide Rails

For convenient and protected transport or storage of up to two FS 1400/2 or shorter guide rails. Durable nylon construction. Guide rails sold separately. Carrying bag with shoulder straps up to length of FS 1400/2.



<u>Code</u>	<u>Price</u>
466357	\$ 125

### Multi-function Table MFT/3

The MFT/3 is the perfect height to make work more comfortable. V-groove channels make squaring the miter gauge easier, more accurate and provides a mechanism for attaching accessories. Includes perforated tops, side channels for attaching clamps, and folding legs to allow two working heights, as well as easy transport. For use with TS Plunge Saws and OF Routers.

#### MFT/3 Basic Table 500608

Includes perforated top and foldaway legs.



#### MFT/3 Table 495315

##### Includes:

- Table with perforated top and foldaway legs
- 42" Guide Rail FS 1080
- Additional Clamp
- Adjustable Stop
- CMS Router Table Miter Gauge
- Guide Rail deflector
- Support and swivel unit



<u>Code</u>	<u>Description</u>	<u>Price</u>
500608	MFT/3 Basic Table, 45" x 30" x 35" Height	\$ 699
495315	MFT/3 Table (w/ added accessories) 45" x 30" x 35" Height	799

#### Clamping Elements MFT

Secure your workpiece for precision routing, sanding, cutting, or just about any other application.



Easy locking and quick release for a secure grip on your material. Designed for a perfect fit with the 20mm holes of the Festool MFT Tables.

<u>Code</u>	<u>Price/pk</u>
488030	\$ 139



## FESTOOL

## SAW BLADES

### Saw Blades for TS Plunge Cut Track Saws



ATB tooth



TC tooth



**Panther Saw Blade**  
Fast-cutting rip blade with aggressive hook angle and deep gullets. Carbide-tipped ATB blade.

**TS 55 REQ**  
496305

**TS 75 EQ**  
495378



**Standard Saw Blade**  
Coarse-cutting rip blade for use with building panels, wood and soft plastics. Carbide-tipped ATB blade.

**TS 75 EQ**  
495379



**Universal Saw Blade**  
Clean-cutting general purpose blade for wood and soft plastics. Fine rip cut blade for glue-ready joints. Carbide-tipped ATB blade.

**TS 55 REQ**  
496304

**TS 75 EQ**  
495380

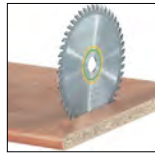

**Fine Tooth Saw Blade**  
Cross-cut blade for smooth results in sheet goods, melamine, hard & soft woods. Carbide-tipped ATB blade.

**TS 55 REQ**  
495377

**TS 75 EQ**  
495381

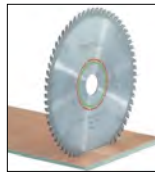

**Solid Surface/Laminate Saw Blade**  
Long-lasting, high-cut quality blade, ideal for laminate flooring and solid surface countertop materials. Carbide tipped TC blade.

**TS 55 REQ**  
496309

**TS 75 EQ**  
495382

### TS 55 REQ Saw blades

Code	Dia.	Kerf	Bore	Hook Angle	Teeth	Price
496305	160	2.2	20	20°	12/ ATB	\$ 56
496304	160	2.2	20	15°	28/ ATB	63
495377	160	2.2	20	5°	48/ ATB	87
496309	160	2.2	20	4°	48/ TC	97

### TS 75 EQ Saw blades

Code	Dia.	Kerf	Bore	Hook Angle	Teeth	Price
495378	210	2.6	30	28°	16/ ATB	\$ 86
495379	210	2.6	30	20°	18/ ATB	88
495380	210	2.4	30	15°	36/ ATB	97
495381	210	2.4	30	8°	52/ ATB	139
495382	210	2.4	30	4°	60/ TC	155

### Saw Blades for TSC Plunge Cut Track Saws



ATB tooth



ATB tooth



TC tooth



**205559 Wood Rip Cut Blade**  
High cutting performance for rip cuts in solid wood. Suitable for hardwood and softwood. Carbide-tipped ATB blade.



**205560 Universal Blade**  
For all types of wood materials, building panels - medium cut. Carbide-tipped ATB blade.

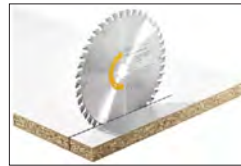

**205561 Fine Tooth Blade**  
Fine cut for clean and splinter-free cross cuts in solid wood as well as for coated or veneered panels.



**205562 Laminate/HPL Blade**  
Long-lasting, high-cut quality blade, ideal for laminate flooring and solid surface countertop materials. Carbide tipped TC blade.

### TSC-55-K Saw blades

Code	Dia.	Kerf	Bore	Teeth	Price
205559	160	1.8	20	12/ ATB	\$ 55
205560	160	1.8	20	28/ ATB	61
205561	160	1.8	20	42/ ATB	84
205562	160	1.8	20	52/ TC	95



## MITER SAW

## FESTOOL

### Kapex KS 120 REB

Sliding Compound Miter Saw

#### Saw Includes:

- 1 60-tooth carbide tipped blade
- Angle transfer device
- Hold down clamp
- hex key, WAF 6



<u>Code</u>	<u>Price</u>
575306	\$ 1575

Light in weight and heavy in features, the KS 120 is the perfect saw for the workshop or the jobsite. Effective dust extraction, precise cuts, easy adjustments, and quality components are some of the features that make this saw the number one choice of professional tradesmen.

- Faster cut alignments with dual-laser marking system
- Rapid miter setting with cam-action lock system
- Rail-forward design allows work in tight quarters
- Angle transfer device eliminates complex angle calculations
- Easy and precise bevel angle with fine adjust
- Dust extraction up to 91% with behind the cut dust hood and pivoting 36mm hose

Power consumption.....	1600 watts
Crown moulding diag cut 45°/90°.....	6-5/8" (168mm)
Crown moulding diag cut 90°/90°.....	6-5/8" (168mm)
Special cutting depth 45°/90° (right).....	3/4" x 4-3/4"
Special cutting depth 45°/90° (left).....	1/2" x 4-3/4"
Special cutting depth 90°/90°.....	2-1/4" x 4-3/4"
Saw blade diameter.....	10-1/4" (260mm)
Dust extraction connection dia.....	1-1/16" / 1-7/16"
Dimensions (LxWxH).....	28" x 19-3/4" x 18-1/2"
Weight.....	50.93 lbs. (23.1 kg)
Work height.....	35-1/2" (900mm)

### KAPEX ACCESSORIES

#### Crown Stop w/ Base Extension

Supports nested workpieces at any angle and provides enhanced material support to the left or right of the saw. Integrated t-slots enable additional clamping capability, expanding the use of job-specific jigs when used with Festool FS clamps.



<u>Code</u>	<u>Price</u>
494369	\$ 129

Includes: 1 base extension and 1 crown stop.

#### Hold Down Clamp

Replacement clamp for securing material to the deck of the KAPEX miter saw (left or right of blade). Non-marring plastic foot protects the material during cutting.



<u>Code</u>	<u>Price</u>
494391	\$ 105

#### Saw Blades for Kapex Miter Saw

##### Solid Surface/Laminate Saw Blade

Long-lasting, high-cut quality blade, ideal for laminate flooring and solid surface countertop materials.

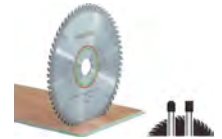

Carbide tipped. 64 tooth; 2.5mm kerf; 30mm arbor; -5 deg hook angle; MATB.

<u>Code</u>	<u>Price</u>
495386	\$ 160

##### Fine Tooth Saw Blade

Cross-cut blade for smooth results in sheet goods, melamine, hard & soft woods.



Carbide-tipped. 80 tooth; 2.5mm kerf; 30mm arbor; -5 deg hook angle; ATB.

<u>Code</u>	<u>Price</u>
495387	\$ 175

##### Universal Saw Blade

Clean-cutting general purpose blade for wood and soft plastics. Fine rip cut blade for glue-ready joints.



Carbide-tipped. 60 tooth; 2.5mm kerf; 30mm arbor; -5 deg hook angle; ATB.

<u>Code</u>	<u>Price</u>
495388	\$ 159

## SANDERS

### 5" RANDOM ORBIT SANDER WITH DUST PICKUP

8-hole Hook & Loop Pad

Model 382  
List \$ 108



8-hole, 5" Hook & Loop

- Top cap design allows users to service and clean out the unit without complete disassembly
- Improved ergonomics allow for comfortable body & top gripping
- Amps: 1.9, 12,000 OPM
- Rubber grip dampens vibration
- 8-hole hook & loop pad. Accepts standard paper.
- Dust canister exceeds durability of cloth dust bags
- Dual dust ports accept 1" and 1-1/2" vacuum hoses to maximize dust pick up
- Standard Equipment: Sander, and operating manual

### BOSCH ROS20VSC RANDOM ORBIT SANDER

Variable Speed



- Variable speed dial
- Integral Pad Dampening system
- Microfilter Dust Canister
- Uses 8-hole 5" Hook & Loop discs

Delivers fast removal and a well-blended, ultra-smooth finish. Integral pad dampening brake system helps prevent swirl marks. Hook-and-loop disc attachment ensures a secure fit. Microcellular backing pad is pliable to ensure a smooth, fine finish on both flat and contoured surfaces alike.

With a comfortable soft-grip top and body design, this tool has variable-speed control from between 7,500 and 12,000 OPM to match the speed to the task. It also includes an on-board system for filtering fine dust.

Code	Description	List/ea
ROS20VSC	5" Random Orbit Sander	\$ 141.67

### BOSCH 3725DEVS RANDOM ORBIT SANDER

With Dust Canister

Model 3725DEVS  
List \$ 286



8-hole, 5" Hook & Loop

- Powerful 3.3 amp motor with variable-speed dial, (4,500-12,000 OPM) to match speed to workpiece and task
- Removable auxiliary handle for close-quarter work
- Microfilter dust canister collects up to 120% more dust than conventional dust bags
- Uses 8-hole, 5" hook and loop discs

#### Specifications:

Voltage.....	120V	Orbit dia.....	3/16"
Disc size.....	5"	Orbit rad.....	3/32"
No load OPM.....	4500-12000		
Eccentric offset..	3/32"		

### BOSCH ROS10 RANDOM ORBIT SANDER

With Dust Canister



#### Includes:

- Soft Sanding Pad
- Dampening Ring
- Microfilter Dust Canister
- Vacuum Hose Adapter
- Sanding Disc

- Integral pad dampening braking system to prevent swirl marks
- 2.5 Amp motor delivers 12,000 OPM
- Hook-and-loop disc attachment for firm grip
- Microcellular backing pad for smooth, fine finishes
- Soft-grip top and body for user comfort
- Low-vibration operation
- Built-in microfilter dust-collection system
- Uses 8-hole 5" hook and loop discs

Code	Description	List/ea
ROS10	5" Random Orbit Sander	\$ 108.33



## DYNABRADE SANDERS

### RANDOM ORBIT AIR SANDER

Dynorbital Spirit

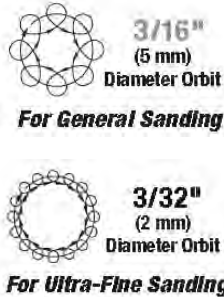

Lightweight, low-profile sander. Random circular motion produces superior finishes. Highly dampened vibration gives smooth, comfortable sanding. Choice of 3/16" orbit or 3/32" orbit. Low air use. 90 PSI. 12,000 RPM. Approx. Wt: 1.40 lbs on 5", 1.50 lbs on 6" Horse power: .25

Includes low-profile, premium urethane, weight-mated, non-vac pad (PN56106). Non-vac with a small ergonomic grip.

Code	Dia./Orbit	List
59020	5" / 3/16"	\$ 322.53
59025	6" / 3/16"	321.46
59035	5" / 3/32"	327.94

### DYNABUG II ORBITAL SANDER, NON-VACUUM

A little finish sander that gets into corners!

- Precise 3/32" orbital motion for an ultra-fine finish
- Light tool weight at 1.75 lbs.
- 74mm wide x 109mm long (approximately 3" x 4-1/4") and includes Hook-Face Sanding Pad. Comfort Platform provides additional hand and wrist support



58500

List \$ 368.57

- Powerful .15 hp (112 W), 10,000 RPM air motor, using just 13 SCFM at 90 PSI.

### Sandpaper for Dynabug Sander

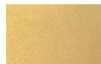

2-15/16" W x 4-5/16" L, A/O Non-Vac Sheets. C-wt flexible paper, Hook & Loop avail 120-400 grits. 50 sheets per box - **Must order in increments of 50.**

120X	150X	180X	220X	320X	400X
93784	93785	93786	93787	93788	93789

120-320 grits \$ .88/sheet, 400 grit \$ .95/sheet.

### RANDOM ORBIT AIR SANDER

Dynorbital Supreme



56815

- New one-hand speed control allows "thumb control"
- Balanced Urethane sanding pad
- Max RPM: 12,000, .28 HP
- Rubber over-mold has a non-slip feel and insulates from cold. The air motor has vibration-absorbing rubber rings
- Comfort Platform gives extra hand and wrist support

### Specifications

HP.....	0.28
Max. Air Flow [SCFM].....	18.0
Max. RPM.....	12,000
Pad Face.....	Vinyl
Tool Spindle Thread.....	5/16" - 24 Female
Exhaust Type.....	Rear
Hose I.D. [inches].....	1/4"
Vacuum Type.....	Non-Vacuum
Width/Length.....	6.5
Height.....	3.625
Weight.....	2 lbs.

Code	Description	List/ea
56815	5", 3/16" Orbit	\$ 425
56850	5", 3/32" Orbit	425



## SANDERS



### RANDOM ORBIT AIR SANDER

Dynorbital Extreme

Quiet - 73 dBA  
vs 80 dBA



#### Features

- Recessed Throttle Lever eliminates pressure on palm
- Integrated Comfort Platform provides ergonomic comfort
- Comfort Grip
- Weight-mated Sanding Pad for reduced vibration and consistent finishes

Dynabrade's most refined random orbital sander to date, it boasts the greatest power and most consistent speed of any palm-style sander. Ergonomic features keep operators safe and comfortable and symmetrical design allows for left or right-handed operators. American-made from the highest grade materials for long-life and high durability.

New motor design has the highest power-to-weight ratio in the industry, with 0.3 hp at 1.8 lbs. Most constant speed under load, running at 92% of rated tool speed.

PSA pad type, Non-vacuum, 12000 rpm, 0.3 hp (224 W).

Code	Dia.	Orbit Dia.	Length	List/ea
X51	5"	3/16"	6.9"	\$ 336.05
X52	5"	3/32"	6.9"	317.03
X61	6"	3/16"	7.4"	317.03

### FILTERS FOR SANDERS

For Spirit and Extreme models

These filters catch the excess oil/dirt/dust that the sanders may spit out while being used. They also double as mufflers that dampen the sound from the exhaust.



Sanders take 4-5 of the filters each and need to be changed out when they turn black (about every two months of regular weekly use).

30 filters per bag, sold per bag.

Code	Description	List/bg
56027	Filters for Extreme Dynabrade Sanders (X51, X52, X61).	\$ 20.50
56054	Filters for Spirit Dynabrade Sanders (5920, 59025, 59035)	22.60

### SURFPREP 3" X 4" ORBITAL AIR SANDER



SPSS3X4 Sanding System

Low profile, compact footprint designed for use on flat surfaces, recessed corners, inside drawer boxes, & profiled moldings, etc. The lightweight nylon composite bodied sanders withstand rugged industrial applications and are excellent for both prep & finish sanding.

#### Specifications:

- Air - 16 SCFM / 3.1 CFM / 90 PSI
- RPM - Suggested Speed 10,000 RPM
- Orbit - 3mm perfect orbit
- Weight - 2 lbs.
- Height x Length - 3.3" x 5.5"
- Size - 3" X 4" Footprint
- Power - .24 Horsepower / 179 Watts



SPBP3X4 Backup Pad

Code	Description	List/ea
SPSS3X4	3" x 4" Orbital Sander, H&L, Non-Vacuum (sander only)	\$ 409.50
SPBP3X4	Backup Pad, 3" x 4", H&L, No hole	31.50
SPSS3X4	Sanding System includes:	555.25
	SPSS3X4 Sander w/pad, Variety Pack 3" x 4" Foam abrasives, Variety Pack 3" x 4" Film abrasives, 12' Swivel Air Hose & Tool Oil, 3" x 4" Pad Saver, 3" x 4" Interface Pad.	

See full selection of Surfprep abrasives starting on page 1755.

## SANDERS



### SURFPREP 3" X 7" ORBITAL AIR SANDER



SPS3X7

Low profile, large footprint designed for use on flat surfaces, recessed corners, large areas & profiled moldings, etc. The durable, lightweight nylon composite bodied sanders withstand rugged industrial applications and are excellent for both prep & finish sanding. Both the Air and Electric Surge can be converted into a more "aggressive leveling sander" with the simple addition of a pad saver with SurfPrep Film cut sheets. You will need a minimum 80 gallon air compressor to run air sanders properly.

**Specifications:**

- Air - 16 SCFM / 3.1 CFM / 90 PSI
- RPM - Suggested Speed 10,000 RPM
- Orbit - 3mm perfect orbit
- Weight - 2.26 lbs.
- Height x Length - 4.15" x 6.93"
- Size - 3-2/3" X 7" Footprint
- Power - .24 Horsepower / 179 Watts



SPBP3X7  
 Backup Pad

Code	Description	List/ea
SPS3X7	3" x 7" Orbital Sander, H&L, Non-Vacuum (sander only)	\$ 430.92
SPBP3X7	Backup Pad, 3" x 7", H&L, No hole	42.00

See full selection of Surfprep abrasives starting on page 1755.

### SURFPREP RANDOM ORBITAL AIR SANDER

5" Trident - 3/16 & 3/32 Orbits



SPTS5

**Specifications:**

- Air - 17 SCFM / 3.1 CFM / 90 PSI
- RPM - Suggested Speed 12,000 RPM
- Orbit - 3/16 & 3/32 Random Orbit
- Weight - 1.84 lbs.
- Height x Length - 3.9" x 7"
- Power - .28 Horsepower / 209 Watts

SPBP5  
 Backup Pad



Light-weight, designed with a durable composite body and a compact, recessed throttle lever. Ergonomically balanced for added comfort and control. Its cutting edge 'cooling fan' creates air flow around the counter balance spindle bearing which enhances the life of the tool. The Trident motor assembly is constructed of hardened steel for the cylinder and both end plates. A 360° swivel exhaust grate allows operator to redirect air flow.

Code	Description	List/ea
SPTS5HL316	5" Hook & Loop, 3/16" orbit Non-Vacuum	\$ 381.50
SPTS5PSA316	5" PSA, 3/16" orbit Non-Vacuum	420.00
SPTS5PSA332	5" PSA, 3/32" orbit Non-Vacuum	350.00
SPBP5HL	Backup Pad, 5", H&L, No hole	35.44
SPBP5PSA	Backup Pad, 5", PSA, No hole	33.75

### GRAPHITE COATED CANVAS

Graphite has long proven the most effective dry lubricant available for use in back of sanding belts to reduce heat and friction, increase speed and provide longer abrasive belt wear. Recommended by most belt-sander manufacturers. Available in 12' lengths only.



Code	Width x Length	List/ea
GC4-1	4" x 12'	\$ 39.22
GC6-1	6" x 12'	52.07
GC8-1	8" x 12'	73.83

## FESTOOL

## SANDERS

### DTS 400 REQ-Plus Delta Sander

A great all-round sander, the DTS 400 is ideal for working on vertical and overhead surfaces because of its compact design and weight of only 2.4 lbs. The electronics improve working results and the vibration stop makes your work less tiring.



576061

Power consumption..... 250 watts  
 Pad size..... 4" x 6" (100 x 150mm)  
 Speed..... 6000 - 12000 opm  
 Sanding stroke..... 5/64" (2mm)  
 Weight..... 2.4 lbs. (1.1 kg)

### DTS 400 REQ-Plus Includes:

- StickFix® sanding pad 4" x 6" (100 x 150mm)
- Plug-it Power cord
- Long life dust bag
- Pad protector
- In Systainer SYS3

Note: Pads not interchangeable with RTS 400 EQ

	<u>Code</u>	<u>Price</u>
	576061	\$ 299

### RTS 400 REQ-Plus Finish Orbital Sander

A sander well suited for a wide range of applications, the RTS 400 is ideal for working on vertical and overhead surfaces because of its compact design and weight of only 2.4 lbs. The electronics improve working results and Vibration Stop balancing reduces fatigue during prolonged use.



576054

Power consumption..... 250 watts  
 Pad size..... 3-5/32" x 5-1/4" (80mm x 133mm)  
 Speed..... 6000 - 12000 opm  
 Sanding stroke..... 5/64" (2mm)  
 Weight..... 2.4 lbs. (1.1 kg)

### RTS 400 REQ-Plus Includes:

- StickFix® sanding pad 3-5/32" x 5-1/4" (80 x 133mm)
- Plug-it Power cord
- Long life dust bag
- Pad protector
- In Systainer SYS3

Note: Pads not interchangeable with DTS 400 EQ

	<u>Code</u>	<u>Price</u>
	576054	\$ 299

### LONG LIFE CHIP COLLECTION BAG

For ETS/DTS/RTS Sanders



<u>Code</u>	<u>Price</u>
201693	\$ 35



Festool reusable long-life dust collection bag made from extra-durable non-woven polyester for lasting use. Attaches to any Festool power tool with a locking 27mm dust port.





## SANDERS

## FESTOOL

### ROTEX RO 125 FEQ-Plus Multi-Mode Sander

The RO 125 puts dual-mode, triple-function performance into a comfortable 4.4 lbs. This 5" sander does coarse sanding, fine sanding and polishing. Perfect for woodworkers, painters, solid surface fabricators and anyone who needs to sand in a variety of places and positions. Near-total dust extraction, exceptional ergonomics, and many advanced features.



576032

#### RO 125 FEQ-Plus Includes:

- StickFix® sanding pad 5" dia (125mm)
- Pad protector
- Plug-it cable
- Systainer SYS3

Power consumption.....	500 watts/ 4.2 amps 120 V AC	<u>Code</u>	<u>Price</u>
Pad diameter.....	5" (125mm)	576032	\$ 579
Speed Eccentric motion.....	3000 - 6000 opm		
Speed Rotary motion.....	300 - 600 rpm		
Sanding stroke.....	9/64" (3.6mm)		
Weight.....	4.4 lbs. (2 kg)		

### ROTEX RO 150 FEQ-Plus Multi-Mode Sander

The RO 150 changes effortlessly from coarse sanding, to fine sanding, to polishing. Changing sanding pads is easy and requires no extra tools. 720 watts of power. The 5 lb. frame has minimal vibration and superior ergonomic design making it easy to work with. The gear box is completely enclosed and impervious to dust.



576028

#### RO 150 FEQ-Plus Includes:

- StickFix® sanding pad 6" dia (150mm)
- Pad protector
- Plug-it cable
- Systainer SYS3

Power consumption.....	720 watts/ 6 amps 120 V AC	<u>Code</u>	<u>Price</u>
Pad diameter.....	6" (150mm)	576028	\$ 669
Speed Eccentric motion.....	3300 - 6800 opm		
Speed Rotary motion.....	320 - 660 rpm		
Sanding stroke.....	3/16" (5mm)		
Weight.....	5 lbs. (2.3 kg)		

### ETS 125 REQ-Plus Random Orbital Sander

The ergonomic ETS 125 has a 5/64" sanding stroke and is an ideal one-handed machine for maximum surface quality when finishing or pre-sanding. Weighing only 2.4 lbs., it is perfect for vertical surfaces and overhead work. Also features sanding pad brake and Vibration Stop balancing.



576070

#### ETS 125 REQ-Plus Includes:

- StickFix® sanding pad 5" dia (125mm)
- Pad protector
- Long life filter bag
- Plug-it cable
- Systainer SYS3

Power consumption.....	200 watts/ 1.67 amps 120 V AC	<u>Code</u>	<u>Price</u>
Pad diameter.....	5" (125mm)	576070	\$ 249
Speed.....	6000 - 14000 opm		
Sanding Stroke.....	5/64" (2.0mm)		
Weight.....	2.4 lbs. (1.1 kg)		



## FESTOOL

## SANDERS

### Random Orbital Sanders ETS 150/3 EQ-Plus and ETS 150/5 EQ-Plus

Two top-of-class, lightweight eccentric sanders in the ETS series: the ETS 150/3 is for fine sanding and extra-fine sanding, producing an excellent surface finish with a short 1/8" sanding stroke. The ETS 150/5, with a 3/16" stroke, is for more aggressive sanding or intermediate varnish sanding. Its maneuverability is a product of superior ergonomics and low weight. The balance of each tool is calibrated to its stroke, delivering smooth, low vibration operation.



### ETS 150/3 EQ-Plus & ETS 150/5 EQ Include:

- StickFix® sanding pad 6" dia (150mm)
- Filter cartridge
- Plug-it cable
- Systainer SYS3

Power consumption.....	310 watts/ 2.6 amps 120 V AC
Pad diameter.....	6" (150mm)
Speed.....	6000 - 10500 opm
Sanding Stroke (150/3).....	1/8" (3.0mm)
Sanding Stroke (150/5).....	3/16" (5.0mm)
Weight.....	2.4 lbs. (1.1 kg)

<u>Code</u>	<u>Price</u>
ETS 150/3 576079	\$ 439
ETS 150/5 576088	439



## SANDERS

## FESTOOL

### ETS EC 125/3 EQ-Plus Brushless Sander

Equipped with the EC-TEC® Brushless Motor, these low-profile, long-life, and low-vibration sanders can run all day with multiple shifts. Offering a fine 3mm stroke, this sander provides the performance of an air sander without the expense and bulk of an air system. Equipped with Multi-Jetstream dust extraction, extraction connection signal, electronic active vibration stop, carbide-tipped sanding brakes and more.



576340

### ETS EC 125/3 EQ-Plus Includes:

- StickFix® sanding pad 5" dia (125mm)
- Plug-it cable
- Systainer SYS3

Power consumption.....	400 watts/ 3.3 amps 120 V AC
Pad diameter.....	5" (125mm)
Speed.....	6000 - 10000 RPM
Sanding stroke.....	1/8" (3.0mm)
Weight.....	2.65 lbs. (1.2 kg)

<u>Code</u>	<u>Price</u>
576340	\$ 475

### ETS EC 150/3 EQ-Plus Brushless Sander

Equipped with the EC-TEC® Brushless Motor, these low-profile, long-life, and low-vibration sanders can run all day with multiple shifts. Available in a fine 3mm stroke, these sanders offer the performance of an air sander without the expense and bulk of an air system. Equipped with Multi-Jetstream dust extraction, extraction connection signal, electronic active vibration stop, carbide-tipped sanding brakes and more.



576326

### ETS EC 150/3 EQ-Plus Includes:

- StickFix® sanding pad 6" dia (150mm)
- Plug-it cable
- Systainer SYS3

Power consumption.....	400 watts/ 3.3 amps 120 V AC
Pad diameter.....	6" (150mm)
Speed.....	6000 - 10000 RPM
Sanding stroke.....	1/8" (3.0mm)
Weight.....	2.65 lbs. (1.2 kg)

<u>Code</u>	<u>Price</u>
576326	\$ 575

### ETS EC 150/5 EQ-Plus Brushless Sander

Equipped with the EC-TEC® Brushless Motor, these low-profile, long-life, and low-vibration sanders can run all day with multiple shifts. Available in a fine 5mm stroke, these sanders offer the performance of an air sander without the expense and bulk of an air system. Equipped with Multi-Jetstream dust extraction, extraction connection signal, electronic active vibration stop, carbide-tipped sanding brakes and more.



576339

### ETS EC 150/5 EQ-Plus Includes:

- StickFix® sanding pad 6" dia (150mm)
- Plug-it cable
- Systainer SYS3

Power consumption.....	400 watts/ 3.3 amps 120 V AC
Pad diameter.....	6" (150mm)
Speed.....	6000 - 10000 RPM
Sanding stroke.....	3/16" (5.0mm)
Weight.....	2.6 lbs. (1.2 kg)

<u>Code</u>	<u>Price</u>
576339	\$ 575



### FESTOOL SANDPAPER

**5" Granat Discs.** Compatible with Festool ETS 125, ROTEX RO 125, ETSC 125 and other 5" sanders.



Code	Grit	Ctn	Price/Bx
497167	P80	50 ea	\$ 47
497168	P100	100	71
497169	P120	100	71
497170	P150	100	71
497171	P180	100	71
497172	P220	100	71
497173	P240	100	71
497175	P320	100	71

**6" Granat Discs.** Compatible with Festool ETS 150, ROTEX RO 150, ETS EC 150 and other 6" sanders.

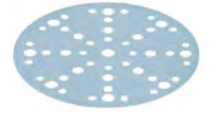

Code	Grit	Ctn	Price/Bx
575162	P80	50 ea	\$ 51
575163	P100	100	77
575164	P120	100	77
575165	P150	100	77
575166	P180	100	77
575167	P220	100	77
575168	P240	100	77
575170	P320	100	77
575172	P400	100	77
575173	P500	100	77
575174	P800	50	51
575175	P1000	50	51

**Rubin2** For bare wood. Dia: 5"



Code	Grit	Ctn	Price/Bx
499094	P60	50 ea	\$ 40
499095	P80	50	40
499096	P100	50	40
499097	P120	50	40
499098	P150	50	40
499099	P180	50	40
499100	P220	50	40

**Rubin2** For paints and varnishes, fine sanding on bare wood. Compatible with DTS 400 EQ. Size: 3-15/16" (100 x 150mm)



Code	Grit	Ctn	Price/Bx
499135	P80	50 ea	\$ 33
499136	P100	50	33
577575	P120	50	33
499138	P150	50	33
499139	P180	50	33

**6" Rubin2 Discs.** Compatible with Festool ETS 150, ROTEX RO 150, ETSC 150 and other 6" sanders.



Code	Grit	Ctn	Price/Bx
575187	P60	50 ea	\$ 44
575188	P80	50	44
575189	P100	50	44
575190	P120	50	44
575191	P150	50	44
575192	P180	50	44
575193	P220	50	44

**Granat** For finished and bare wood. Size: 3-15/16" (100 x 150mm)



497138	P120	100 ea	\$ 57
497139	P150	100	57
497140	P180	100	57
497141	P220	100	57
497142	P240	100	57
497143	P320	100	57
497144	P400	100	57



## FESTOOL SANDPAPER

**Rubin2** For bare wood.  
Size: 4-1/2" x 9" (115 x 228mm)



Code	Grit	Ctn	Price/Bx
499034	P120	50 ea	\$ 42
499035	P150	50	42
499037	P220	50	42

**Granat** For bare wood.  
Size: 3-1/8" x 5-1/4" (80 x 133mm)



Code	Grit	Ctn	Price/Bx
497119	P80	50 ea	\$ 33
497120	P120	100	53
497121	P150	100	53
497122	P180	100	53
497123	P220	100	53
497124	P280	100	53
497125	P320	100	53

**Rubin2** For bare wood.  
Size: 3-1/8" x 5-1/4" (80 x 133mm)



499048	P80	50	\$ 30
499049	P100	50	30
499050	P120	50	30
499051	P150	50	30
499052	P180	50	30
499053	P220	50	30

**6" Platin2 Discs.** Compatible with Festool ETS 150, ROTEX RO 150, ETSC 150 and other 6" sanders.



Code	Grit	Ctn	Price/Bx
492370	P1000	15 ea	\$ 91
492371	P2000	15	91

### **SIA 9-Hole HOOK & LOOP DISCS**

For Festool Sanders



- 5" or 6" 9-hole discs
- Aluminum oxide grit
- B-weight paper
- Ideal for manual use thanks to high flexibility
- Ideal for sanding large areas

Pack: 100 discs per box.

Code	Size	Grit	List/bx
4554.0675.0080	5"	80	\$ 78.05
3547.7578.100	5"	100	78.97
3547.7578.120	5"	120	94.28
3547.7578.150	5"	150	94.42
3547.7578.180	5"	180	84.26
3547.7578.220	5"	220	95.92
3365.8780.80	6"	80	\$ 124.78
3365.8780.100	6"	100	112.54
3365.8780.120	6"	120	116.91
3365.8780.150	6"	150	129.17
3365.8780.180	6"	180	108.48
3365.8780.220	6"	220	110.29



## FESTOOL

## BACKING PADS

### SANDER BACKING PADS

For Festool Sanders



StickFix Longlife 5" Soft Pad  
**492280**  
For ETS 125 EQ  
Random Orbital Sander



Fusion Tec 6" Pads  
**202458** (Soft Pad - black)  
**202459** (Ultra-Soft Pad - gray)  
**202460** (Hard Pad - blue)  
For ETS 150, ETS EC 150  
Sanders



StickFix 5" Soft Pad  
**492125**  
For Rotex RO 125 FEQ  
Multi-Mode Sander



StickFix 6" Pads  
**202461** (Soft Pad - black)  
**202462** (Ultrasoft Pad- gray)  
**202463** (Hard Pad - blue)  
For Rotex RO 150 FEQ  
Multi-Mode Sander

High-Temp resistant for heavy-duty applications.  
9-hole.

<u>Code</u>	<u>Dia.</u>	<u>Sander</u>	<u>Net/ea</u>
492280	5"	ETS 125 EQ	\$ 46
202458	6"	ETS 150, ETS EC 150	55
202459	6"	ETS 150, ETS EC 150	52
202460	6"	ETS 150, ETS EC 150	52
492125	5"	RO 125 FEQ	44
202461	6"	RO 150 FEQ	55
202462	6"	RO 150 FEQ	55
202463	6"	RO 150 FEQ	55

### SANDER BACKING PADS cont.

For Festool Sanders



80x133mm Soft Backing Pad  
**489252**  
For RTS 400 REQ Sander



100x150mm Soft Backing Pad  
**493723**  
For DTS 400 REQ Sander

<u>Code</u>	<u>Size</u>	<u>Sander</u>	<u>Net/ea</u>
489252	80x133mm	RTS REQ	\$ 35
493723	100x150mm	DTS REQ	35

### BACKING PADS

For Festool ETS EC Sanders

The ETS EC 125 requires a different pad than the ETS 125. Below backing pads have a central fastener to affix to the sander, but still use the same abrasives that the ETS 125 uses. The ETS EC 150 sanders utilize the same sanding pads as the ETS 150 sanders.



5" Hard Sander Backing Pad  
**492284**  
For ETS EC 125 Brushless Sander



5" Soft Longlife Sander  
Backing Pad - **492286**  
For ETS EC 125 Brushless Sander



5" Super Soft Sander  
Backing Pad - **492288**  
For ETS EC 125 Brushless Sander

<u>Code</u>	<u>Dia.</u>	<u>Sander</u>	<u>Net/ea</u>
492284	5"	ETS EC 125	\$ 52
492286	5"	ETS EC 125	52
492288	5"	ETS EC 125	52

## ROUTER BITS

## MLCS

### ROUTER BIT SET - 30 PC MLCS

Outstanding value. An MLCS bit rated 6th out of the 17 brands tested in Fine Woodworking (8/99).



Each set includes 30 carbide tipped, high quality router bits with wood storage box. Each set includes:

- 3 Cove (1/4", 3/8", 1/2")
- 2 Flush Trim (3/8", 1/2")
- 3 Dovetail (14° 1/2", 5/8", 9° 3/8")
- 1 45° Chamfer, 2 Roman Ogee (5/32", 1/4")
- 6 Round Over (1/8", 3/16", 1/4", 5/16", 3/8", 1/2")
- 5 Straight (1/4", 5/16", 3/8", 1/2", 3/4")
- 1 Rabbeting (3/8"), 3 Round Nose (1/4", 3/8", 1/2")
- 1 Bevel (25°), 1 Slot Cutter (1/4")
- 1 V-Groove (1/2"), 1 Panel Pilot (3/8")
- 1 Allen Wrench and 1 bearing to convert Round Over bit into Beading bit, and wood storage box. Available in 1/4" and 1/2" shank.

Code	Description	List
8369	30 Bit Set, 1/2 Shank	\$ 211.63
6069	30 Bit Set, 1/4 Shank	218.09

### FLUSH TRIM ROUTER BITS - MLCS



2 flute, carbide tipped flush trim bits with totally enclosed ball bearing guides. For use in trimming laminates and pattern routing.

V-notch bits make a "V" where two pieces join together, hiding a less than perfect joint.

Code	Bit	Large Dia.	Cutting Length	Shank Size	List
5500	Flush	3/8"	1/2"	1/4"	\$ 15.20
5501	Flush	3/8"	1"	1/4"	24.77
5503	Flush	1/2"	1"	1/4"	21.57

### EURO-TRIMMER LAMINATE TRIMMING BIT

Revolutionary Design

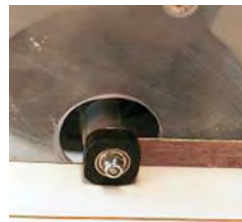

Square Teflon Bearing



ET-34



ET-12

The Euro-Trimmer with square Teflon bearing will not scratch laminates, and glue will not stick to the bearing (other designs clog with contact adhesive).

The 3/4" diameter cutter with a 2° bevel provides very smooth cuts. When using the bit there is no need to lubricate surface. Do the same work in less time.

Specifications: Cutter: Tungsten Carbide  
 Bearing: Black Teflon

Code	Description	List
ET-12	1/2" Euro-Trimmer with 1/4" Shank For hand held routers	\$ 43.06
ET-34	3/4" Euro-Trimmer with 1/4" Shank For larger routers and router tables	46.87
ET12B	Teflon bearing for ET-12	13.83
ET34B	Teflon bearing for ET-34	13.17



## CMT

## ROUTER BITS

### CMT RABBETING BITS

Carbide tipped.  
With ball-bearing guides

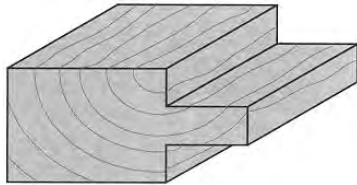

Carbide faced rabbeting bits are fast and accurate. You can quickly produce 3/8" inset doors and drawer fronts, make strong rabbeted joints, mill perfect tongue and groove joints, etc.

Code	Shank	Cut Dia.	Cut Length	Cut Depth	Bearing Dia.	List
835.317.11	1/4"	1-1/4"	1/2"	3/8"	1/2"	\$ 35.10
835.817.11	1/2"	1-1/4"	1/2"	3/8"	1/2"	36.96

### CMT RABBETING SETS

Carbide Tipped

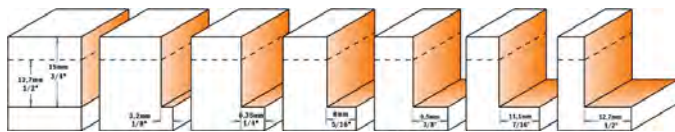

CMT rabbeting sets allow you to make a limitless number of cuts by adjusting the cutting height on your router and changing the bearing on the bit. Each set comes complete with one rabbeting bit and six interchangeable ball-bearing guides.

Code	Shank	Cut Dia.	Cut Length	Cutting Depth	List/set
835.001.11	1/4"	1-3/8"	1/2"	1/8" to 1/2"	\$ 70.88
835.501.11	1/2"	1-3/8"	1/2"	1/8" to 1/2"	66.22

### CMT ROUNDOVER BITS

Carbide Tipped. With ball-bearing guides

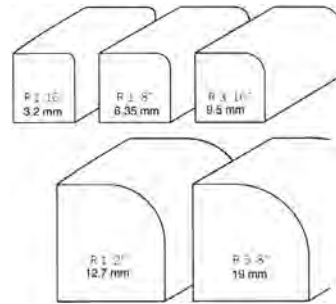

Code	Shank	Cutting Radius	Ovall Dia.	Cut Length	Bearing Dia.	List
838.190.11	1/4"	1/8"	3/4"	1/2"	1/2"	\$ 35.84
838.254.11	1/4"	1/4"	1"	1/2"	1/2"	40.35
838.754.11	1/2"	1/4"	1"	1/2"	1/2"	43.38
838.317.11	1/4"	3/8"	1-1/4"	9/16"	1/2"	41.77
838.817.11	1/2"	3/8"	1-1/4"	9/16"	1/2"	41.70
838.380.11	1/4"	1/2"	1-1/2"	3/4"	1/2"	45.03
838.990.11	1/2"	3/4"	2"	1"	1/2"	74.17

### CMT BEARINGS

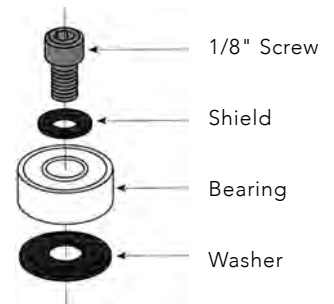

BE SURE to keep the black bearing washer right side up to correspond with the bearing rotation when re-assembling the bearing.

Code	Outside Dia.	Inside Dia.	List
791.002.00	3/8"	3/16"	\$ 5.68
791.003.00	1/2"	3/16"	4.60





## ROUTER BITS

## CMT

### CMT FLUSH & V-GROOVE BITS

Carbide Tipped with ball-bearing guide.

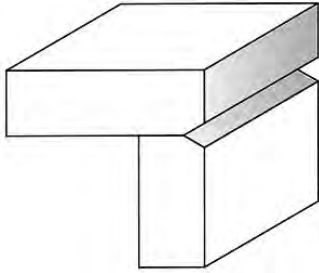

<u>Code</u>	<u>Cut Shank</u>	<u>Cut Dia.</u>	<u>Ovall Length</u>	<u>Length</u>	<u>List</u>
853.001.11	1/4"	1/2"	1"	3/4"	\$ 33.72
853.501.11	1/2"	1/2"	1"	3/4"	37.50

### CMT FLUSH TRIM BITS

Carbide Tipped with ball-bearing guides.

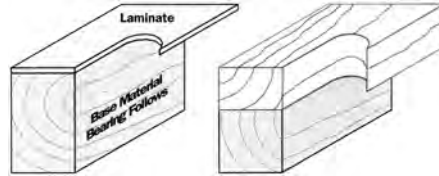

<u>Code</u>	<u>Shank</u>	<u>Cut Dia.</u>	<u>Cut Length</u>	<u>Bearing Dia.</u>	<u>List</u>
806.096.11	1/4"	3/8"	1/2"	3/8"	\$ 23.21
806.128.11	1/4"	1/2"	1/2"	1/2"	22.81
806.127.11	1/4"	1/2"	1"	1/2"	21.79
806.627.11	1/2"	1/2"	1"	1/2"	25.71

### CMT SUPER-DUTY FLUSH TRIM BITS

Carbide Tipped with ball-bearing guides.

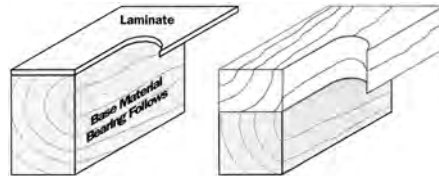

New super duty bits represent the finest of the CMT flush trim bits with ball-bearing guides. Negative shear angle cutting edge and 3/4" cutting diameter. A superior finish with absolute minimal chipping.

<u>Code</u>	<u>Shank</u>	<u>Cut Dia.</u>	<u>Cut Length</u>	<u>List</u>
806.191.11	1/4"	3/4"	1"	\$ 34.13
806.691.11	1/2"	3/4"	1"	37.31
806.690.11	1/2"	3/4"	2"	46.20



## CMT

## ROUTER BITS

### CMT STRAIGHT BITS

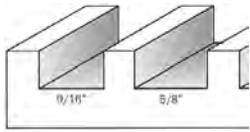

812  
Long Series



811  
Short Series

### Long Series - 812 Carbide Tipped

Code	Shank	Cut Dia.	Cut Length	Overall Length	List
812.595.11	1/2"	3/8"	1-1/4"	2-7/8"	\$ 25.50
812.127.11	1/4"	1/2"	1-1/4"	2-3/4"	23.15
812.690.11	1/2"	3/4"	1-1/2"	3-1/4"	31.32

### Short Series - 811 Carbide Tipped

811.127.11	1/4"	1/2"	3/4"	2-1/4"	\$ 22.84
------------	------	------	------	--------	----------

### CMT PATTERN BITS - Carbide Tipped



812B  
Long  
Series



811B  
Short  
Series



Code	Shank	Cut Dia.	Cut Length	Overall Length	List
812.127.11B	1/4"	1/2"	1-1/4"	2-3/4"	\$ 40.63
811.127.11B	1/4"	1/2"	3/4"	2-1/4"	32.03

Bearing Dia: 1/2"

### CMT MORTISING BITS - Carbide Tipped

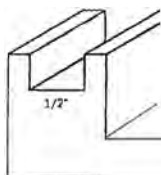
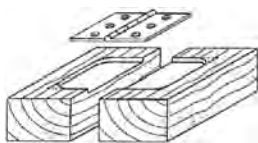

Code	Shank	Cut Dia.	Cut Length	List
801.128.11	1/4"	1/2"	5/16"	\$ 23.91

### CMT CARBIDE TIPPED BORING BITS

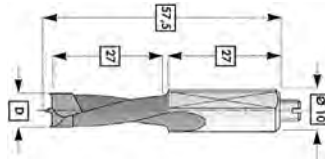

5mm, 8mm

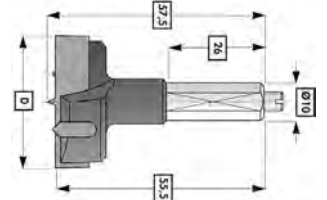

35mm, 40mm

CMT carbide tipped boring bits have "fatigue proof" Swiss steel body, micrograin carbide tips, bake-on PTFE non-stick coating and superb workmanship. Capable of high feed rates in CNC and multi-spindle boring machines. Made in Italy. (Not for use with 3-jawed chucks.)

Bit Dia.	Right Hand	Left Hand	List
5mm	310.050.11	310.050.12	\$ 16.00
8mm	310.080.11	310.080.12	21.12
35mm	317.350.11	--	42.08
40mm	317.400.11	--	64.41

### CMT BABY LOCK MITER

Cut Angle 45°

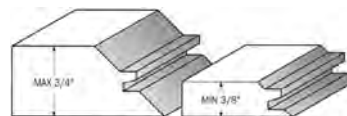

Lock miter bit is ideal for milling miter joints in 3/4" stock. The quick and easy way to accurately create boxes, stretcher bars, frames and any assortment of right angle or parallel joint projects.

Code	Cut Dia.	Cut Length	Max joint thickness	Shank	List
855.504.11	2"	7/8"	3/4"	1/2"	\$ 119.99



## ROUTER BITS

## BOSCH

### STRAIGHT BITS

Provides exceptional smooth and balanced cutting with minimal vibration. Positive hook angles cut efficiently, and specially designed tips allow for fast plunge cutting. Strong webbing and heavy cutter backing provide superior bit life.

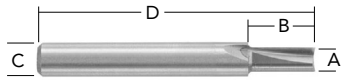

Solid Carbide, Double Flute

Bit No.	A Overall Dia.	B Cutting Edge Lgth	C Shank Dia.	D Overall Length	List
85213M	1/8	7/16	1/4	2	\$ 25.24

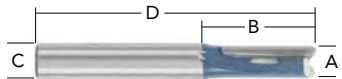

Carbide Tipped,  
Double Flute

Bit No.	A Overall Dia.	B Cutting Edge Lgth.	C Shank Dia.	D Overall Length	List
85221M	1/4	5/8	1/4	2	\$ 23.75
85250M	1/4	7/8	1/4	2-1/8	26.18
85223M	9/32	1	1/4	2-1/4	27.13
85224M	5/16	1	1/4	2-1/4	24.44

### ROMAN OGEE BIT

**Two Flutes, Carbide Tipped, Ball-bearing Pilot**  
For decorative edging and period furniture.

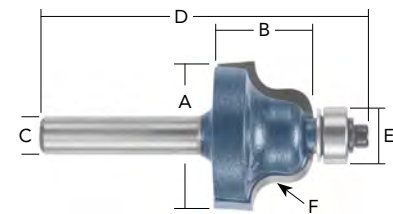

Bit No.	A Overall Dia.	B Cutting Edge Lgth	C Shank Dia.	D Overall Length	E Brng Dia.	F Radius	List
85270M	1	5/8	1/4	2-1/8	1/2	5/32	\$ 52
85271M	1-3/8	7/8	1/4	2-1/4	1/2	1/4	55

### EDGE BEADING BIT

**Carbide Tipped, Ball-Bearing Pilot**

Versatile bit adds attractive edging on new pieces and matches many older molding cuts for remodeling work.

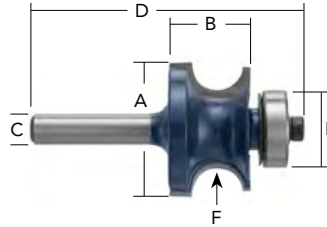

Bit No.	A Overall Dia.	B Cutting Edge Lgth	C Shank Dia.	D Overall Length	E Brng Dia.	F Radius	List
85668M	1-1/4	3/4	1/4	2-1/4	5/8	1/4	\$ 56

### GROOVE FORMING BITS

**Carbide Tipped V-groove & Scoring Bits**

For door front grooving, lettering and sign work. Shear angle cutter geometry for smooth, efficient cutting.

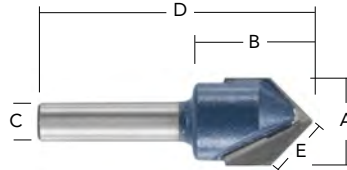

Bit No.	A Overall Dia.	B Cutting Edge Lgth	C Shank Dia.	D Overall Length	E Bevel	List
85219M	9/16	3/4	1/4	1-3/4	3/8 (45°)	\$ 30

### GROOVE FORMING BITS & CUTTERS Solid Carbide

**KEYHOLE BITS - Two Flute, Plunge and Slot Cuts**

Routes mounting slots in picture frames, plaques.

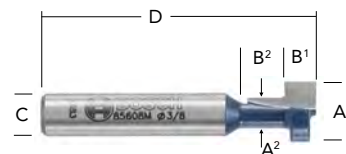

Bit No.	A1 Large Dia.	A2 Small Dia.	B Cutting Edge	C Shank Dia.	D Overall Lgth	List
85608M	3/8	3/16	3/8	1/4	1-7/8	\$ 30

## BOSCH

## ROUTER BITS

### ROUNDING OVER BITS

#### Two Flutes, Carbide Tipped, Ball-Bearing Pilot

For smooth, uniformly rounded edges. Lower depth setting produces rounded corner with decorative bead.

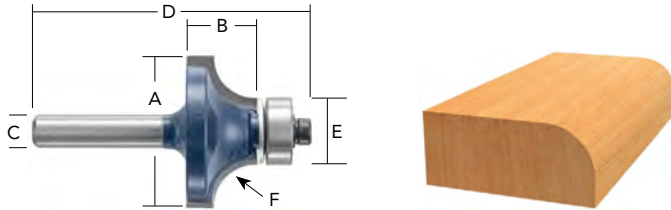

Bit No.	A Overall Dia.	B Cutting Edge Lgth.	C Shank Dia.	D Overall Length	E Brng Dia.	F Radius	List
85289M	5/8	5/16	1/4	1-3/4	1/2	1/16	\$ 50
85290M	3/4	3/8	1/4	2	1/2	1/8	50
85588M	3/4	3/8	1/2	2-5/16	1/2	1/8	51

### BEVEL TRIMMER - Solid carbide

Provides 7-1/2° bevel on trim edge of plastic laminate surfaces. Self-pilot eliminates guide assembly.

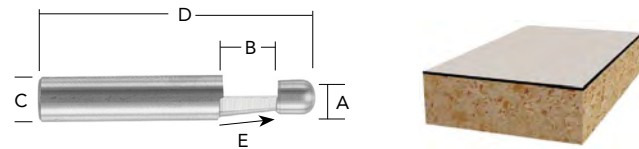

Bit No.	A Overall Dia.	B Cutting Edge Lgth.	C Shank Dia.	D Overall Lgth.	E Angle	List
85286	1/4	1/4	1/4	1-1/2	1/2	\$ 14

### LAMINATE TRIM BITS & CUTTERS

#### 2 FLUTE LAMINATE FLUSH TRIMMING BITS

##### Carbide Tipped Ball-Bearing Pilot

For fast, smooth accurate trim cuts. Shielded compact ball-bearing pilot.

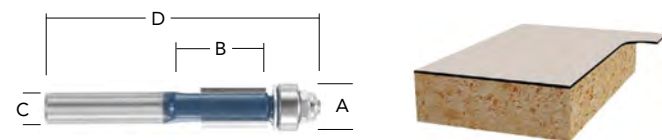

Bit No.	A Overall Dia.	B Cutting Edge Lgth.	C Shank Dia.	D Overall Length	List
85269M	3/8	1/2	1/4	2-1/8	\$ 26
85266M	1/2	1	1/4	2-5/8	26
85441M	1/2	1	1/2	3-1/4	

### LAMINATE TRIM BITS & CUTTERS

#### 3 FLUTE LAMINATE FLUSH TRIMMING BIT

##### Carbide Tipped, Ball-Bearing Pilot

Gives chatter free production trimming with extra smooth trim cut. Compact ball bearing assembly is equipped with glue shield.

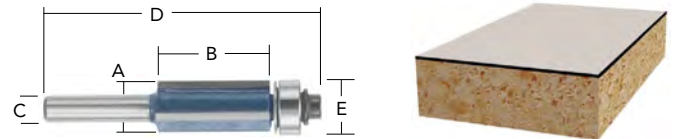

Bit No.	A Overall Dia.	B Cutting Edge Lgth.	C Shank Dia.	D Overall Length	E Bearing Dia.	List
85216M	1/2	1	1/4	2-5/8	1/2	\$ 40

#### 2 FLUTE ECONOMY LAMINATE TRIMMER ASSEMBLIES

##### Carbide Tipped Ball-Bearing Pilot

For fast, accurate trim cuts. Economy priced replaceable cutter and bearing.

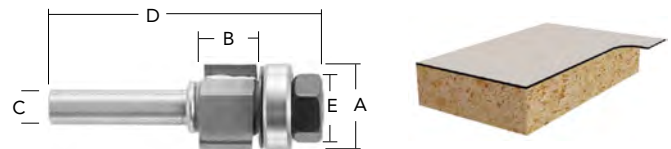

Bit No.	A Overall Dia.	B Cutting Edge Lgth.	C Shank Dia.	D Overall Length	E Brng Dia.	Angle	List
85430M	5/8	3/8	1/4	1-15/16	5/8	Flush	\$ 25

#### 4 FLUTE LAMINATE TRIMMER ASSEMBLIES

##### Carbide Tipped, Ball-Bearing Pilot

For ultra-smooth finish trimming. Ball-bearing is equipped with glue shield. Components are individually replaceable.

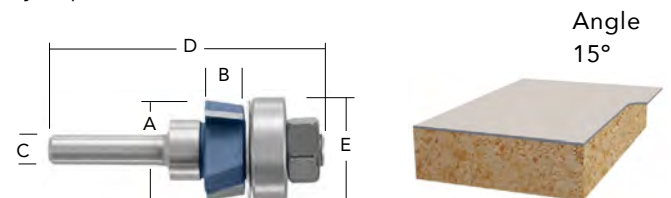

Bit No.	A Overall Dia.	B Cutting Edge Lgth.	C Shank Dia.	D Overall Lgth.	E Bearing Dia.	List
85415M	7/8	5/16	1/4	2-1/8	7/8	\$ 43

## PLUNGE ROUTER BITS

## AMANA

### STRAIGHT PLUNGE CUTTING BITS

### STRAIGHT PLUNGE CUTTING BITS

#### 1/4" Shank - Single Flute



Tool No.	Cutting Dia.	Cutting Length	Shank Dia.	Overall Length	List
45100	1/8	7/16	1/4	2	\$ 21.78
45102	3/16	7/16	1/4	2	21.79
45108	1/4	1	1/4	2-1/4	23.86

#### 1/2" Shank - Single Flute



Tool No.	Cutting Dia.	Cutting Length	Shank Dia.	Overall Length	List
45302	3/8	1	1/2	2-3/4	\$ 27.04



#### 1/4" Shank - 2 Flute

Tool No.	Cutting Dia.	Cutting Length	Shank Dia.	Overall Length	List
45200* $\infty$	1/8	7/16	1/4	2	\$ 23.20
45202*	3/16	7/16	1/4	2	24.87
45204-	1/4	1/2	1/4	2	22.85
45208	1/4	3/4	1/4	2	23.46
45210	1/4	1	1/4	2-1/4	24.16
45218	3/8	1	1/4	2-1/4	26.78
45226	1/2	1	1/4	2-1/8	28.56
45228	5/8	3/4	1/4	2	29.88
45230	3/4	3/4	1/4	2	33.01

#### 1/2" Shank - 2 Flute



Tool No.	Cutting Dia.	Cutting Length	Shank Dia.	Overall Length	List
45408*	1/4	3/4	1/2	2-1/2	\$ 30.28
45412	5/16	1	1/2	2-3/4	28.56
45413	3/8	3/4	1/2	2-1/2	28.16
45414	3/8	1	1/2	2-3/4	28.16
45418	1/2	1	1/2	2-5/8	28.16
45420	1/2	1-1/4	1/2	2-7/8	28.31
45422	1/2	1-1/2	1/2	3-1/8	29.88
45426	1/2	2	1/2	4-1/4	38.67
45427§	1/2	2-1/2	1/2	4-1/2	53.18
45432	5/8	1-1/4	1/2	2-7/8	35.28
45440	3/4	1-1/4	1/2	2-7/8	37.47
45441	3/4	2	1/2	3-5/8	77.19
45442	3/4	1-1/2	1/2	3-1/8	41.88
45448	1	1-1/4	1/2	2-7/8	44.94



- \* With solid carbide cutting edge
- § Not guaranteed due to extreme length
- $\infty$  Not guaranteed due to extreme diameter

## AMANA

## ROUTER BITS

### FLUSH TRIM BITS

With Ball-Bearing Guide



#### 2 Flute

Tool No.	Flutes	Cutting Dia.	Cutting Length	Shank Dia.	Overall Length	List
47090*	2	1/4	1/2	1/4	2-1/4	\$ 40.64
47092*	2	1/4	1	1/4	2-1/2	42.26
47100	2	3/8	1	1/4	2-5/8	28.31
47102	2	3/8	1/2	1/4	2-1/8	27.93
47104	2	1/2	1	1/4	2-5/8	27.65
47106	2	1/2	1/2	1/4	2-1/4	27.20
47108	2	1/2	1	1/2	3-1/4	29.82

\* 1/4" diameter for closer inside corner cutting.

#### 3 Flute

Tool No.	Flutes	Cutting Dia.	Cutting Length	Shank Dia.	Overall Length	List
47114	3	1/2	1	1/4	2-5/8	\$ 37.51

Replacement Bearings:

1/4" dia. = 47723

1/2" dia. = 47706

3/8" dia. = 47702

### EXTRA LONG FLUSH TRIM BIT



Tool No.	Flutes	Cutting Dia.	Cutting Length	Shank Dia.	Overall Length	List
47124	2	1/2	1-1/2	1/2	3-7/8	\$ 45.68

Replacement bearing(s) 47706

### FLUSH TRIM "V" GROOVE BITS - 2 Flute

With Ball-Bearing Guide



Tool No.	Flutes	Cutting Dia.	Cutting Length	Shank Dia.	Overall Length	List
47160	2	5/8	1	1/4	2-1/2	\$ 49.49
47162	2	5/8	1	1/2	3	53.18

Replacement bearing 47706

### "V" GROOVE BIT - 2 Flute



Code	a°	D	B	B1	d	L	List
45700	90°	3/8	7/16	3/16	1/4	1-5/8	\$ 39.13
45705	60°	1/2	5/8	7/16	1/4	1-3/4	49.32

### FLUSH TRIM PLUNGE BITS - 2 Flute

With Upper Ball-Bearing

Very useful for template and pattern routing where the template is **on top** of the workpiece. Ball-bearing guide rides against the template for an exact duplication. If used on a router table, the pattern will be on the bottom, below the workpiece.



Tool No.	Cutting Dia.	Cutting Length	Shank Dia.	Overall Length	List
45460	1/2	1	1/4	2-1/2	\$ 43.78
45464	3/4	1	1/4	2-1/2	48.02
45468	1-1/8	1-1/2	1/2	3-1/2	100.95



## ROUTER BITS

## AMANA

### CHAMFER BITS - 2 Flute

With Ball-Bearing Guide

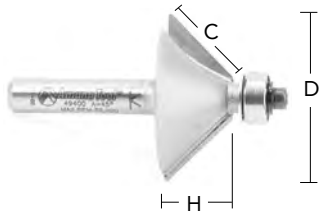

Tool No.	Degree of Angle	'D' Large Dia.	'H' Carb. Ht.	'C' Cut. Lngth	Shank Dia.	OA Length	List
49400	45°	1-1/4	1/2	5/8	1/4	2	\$ 49.13
49402	45°	1-1/4	1/2	5/8	1/2	2-3/8	50.60
49412	30°	1-3/8	3/4	7/8	1/4	2-1/4	53.73

### NO-FILE FLUSH TRIM BIT

with Ball-Bearing Guide

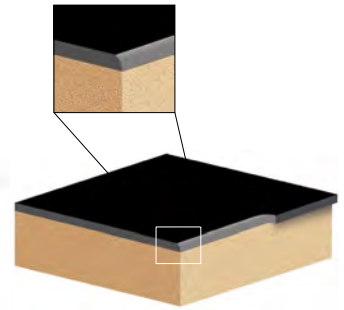

New "No-File™" Bit eliminates hand filing of laminates that normally follows trimming. They will flush trim the laminate and "break" the sharp edges all in one pass. Carbide tip.

Code	Dia.	Cut Length	Shank Dia.	List/ea
47150	1/2"	3/8"	1/4"	\$ 45.60

### BEVEL TRIM BITS - 3 Flute



Tool No.	Bevel Degree	Flutes	Carbide Height	Shank Dia.	Overall Length	List
47300	23°	3	7/16	1/4	1-7/8	\$ 43.44
47302	7°	3	7/16	1/4	2	45.90

### HELIX LAMINATE TRIMMER - 2 Flute

With Ball-Bearing Guide



### BEADING BITS - 2 Flute

With Ball-Bearing Guide



Tool No.	Rad.	Large Dia.	Carb. Ht.	Shank Dia.	Ov/all Length	List
49604	1/4	1	1/2	1/4	2	\$ 37.88
49612	3/8	1-1/4	5/8	1/4	2-3/16	42.31

Replacement Bearing No. 47702

Tool No.	Type of Cut	Flutes	Cutting Dia.	Cutting Length	Shank Dia.	Overall Length	List
47180	Flush	2	5/8	5/8	1/4	2	\$ 39.32
47184	15° Bvl	2	3/4	3/8	1/4	2	42.92

Replacement Bearing for 47180 is 47712  
Replacement Bearing for 47184 is 47714



## AMANA

## EDGE FORMING BITS

### CORNER ROUNDING BITS - 2 Flute

With Ball-Bearing Guide

1/16" to 1-1/2" Radius



Tool No.	Radius	Large Dia.	Carbide Height	Shank Dia.	Overall Length	List
49492	1/16	5/8	5/16	1/4	1-3/4	\$ 33.94
49496	1/8	3/4	3/8	1/4	2	35.44
49499	5/32	3/4	3/8	1/4	2	37.69
49504	1/4	1	1/2	1/4	2	37.85
49506	1/4	1	1/2	1/2	2-7/16	37.85
49508	5/16	1-1/8	1/2	1/4	2-1/16	37.85
49512	3/8	1-1/4	5/8	1/4	2-3/16	42.31
49514	3/8	1-1/4	5/8	1/2	2-9/16	42.31
49516	1/2	1-1/2	3/4	1/4	2-1/4	49.64
49518	1/2	1-1/2	3/4	1/2	2-5/8	49.86
49519	5/8	1-3/4	7/8	1/2	2-3/4	74.76
49520	3/4	2	1	1/2	2-7/8	82.76
49522*	1	2-1/2	1-1/4	1/2	3-3/16	161.20
49526*	1-1/2	3-1/2	1-3/4	1/2	3-5/8	241.83

Replacement Bearing 47706

\* Not guaranteed due to extreme diameter and radius. For best results it is recommended to use a smaller radius bit or chamfer the material prior to using these large radius tools. Tool life will be prolonged and a smoother finish will result.

### COVE BITS - 2 Flute

With Ball-Bearing Guide

3/16" to 1/2" Radius



Tool No.	Rad.	Large Dia.	Carbide Height	Shank Dia.	OA Length	List
49112	3/8	1-1/8	9/16	1/4	2	\$ 52.56
49118	1/2	1-3/8	3/4	1/2	2-1/2	62.38

### STAGGER TOOTH PLUNGE CUTTING BITS



Tool No.	Cutting Dia.	Shank Dia.	Cutting Length	Overall Length	List
51308	1/2	1/2	2	4-1/4	\$ 40.84

### MORTISING BIT - 2 Flute



**Note:** A proper mortising bit, as shown, should have a large gullet between the two flutes, indicated with the arrow.



Tool No.	Cutting Dia.	Cutting Length	Shank Dia.	Overall Length	List
45500	1/2	3/4	1/4	2	\$ 25.88





## ROUTER BITS

## AMANA

### DOUBLE ROMAN OGEE BITS - 2 Flute

With Ball-Bearing Guide

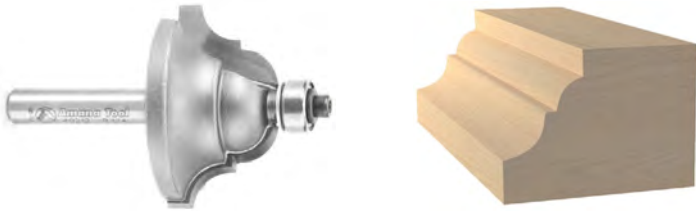

<u>Tool No.</u>	<u>Large Dia.</u>	<u>Each Radius</u>	<u>Carbide Height</u>	<u>OA Length</u>	<u>Shank Dia.</u>	<u>List</u>
49212	1-3/8	1/4	7/8	2-1/4	1/4	\$ 71.33

### ROMAN OGEE BITS - 2 Flute

With Ball-Bearing Guide



<u>Tool No.</u>	<u>Large Dia.</u>	<u>Each Radius</u>	<u>Carbide Height</u>	<u>OA Length</u>	<u>Shank Dia.</u>	<u>List</u>
49200	1	5/32	5/8	2-1/8	1/4	\$ 46.96
49204	1-3/8	1/4	7/8	2-1/4	1/2	46.96
49206	1-3/8	1/4	7/8	2-5/8	1/2	50.15

### BEVEL TRIM - 2 Flute

With Ball-Bearing Guide



<u>Tool No.</u>	<u>Angle Deg.</u>	<u>Dia.</u>	<u>Cutting Height</u>	<u>OA Length</u>	<u>Shank Dia.</u>	<u>List</u>
47200	15°	5/8	9/32	1-7/8	1/4	\$ 33.51

### PANEL PILOT BITS - 1 Flute

Solid Carbide



51200



51202

<u>Tool No.</u>	<u>Type of Cut</u>	<u>Cut. Dia.</u>	<u>Shank Dia.</u>	<u>Cut. Length</u>	<u>Overall Length</u>	<u>List</u>
51200	Flush	1/4	1/4	1/4	1-1/2	\$ 19.01
51202	7°	1/4	1/4	1/4	1-1/2	19.01

### ROUTER ARBORS WITH HEX NUT AND WASHERS



Application: 2 and 3-wing slotting assemblies and single 4-wing trim cutter assemblies.

<u>Code</u>	<u>D</u>	<u>B</u>	<u>C</u>	<u>d</u>	<u>A</u>	<u>List</u>
47600	5/16-24 NF	7/8	2-3/8	1/4	1-1/4	\$ 7.03
47604	5/16-24 NF	7/8	2-3/8	1/2	1-1/2	7.03



## AMANA

## ROUTER BITS

### **RABBETING BITS - 2 Flute - Depth of Rabbet 3/8"** With Ball-Bearing Guide

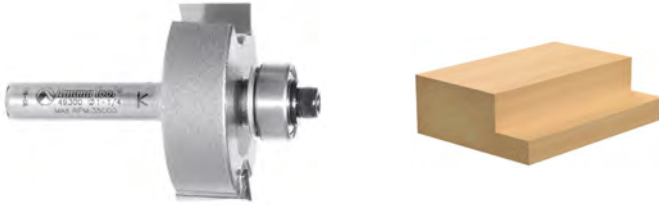

Tool No.	Cutting Dia.	Cutting Length	Shank Dia.	Overall Length	List
49300	1-1/4	1/2	1/4	2	\$ 49.99
49302	1-1/4	1/2	1/2	2-3/8	52.72

Replacement Bearings:  
 3/8 Rabbet 47706  
 7/16 Rabbet 47702

### **RABBETING BITS - 2 Flute** With 4 Ball-Bearings Four Different Depth of Rabbet

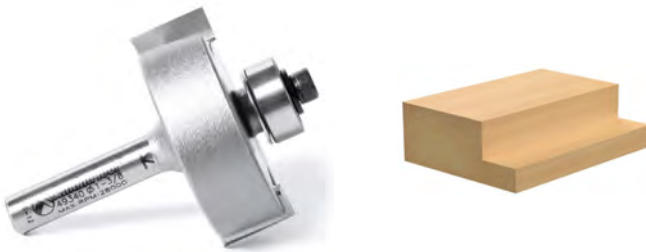

Tool No.	Cutting Dia.	Cutting Length	Shank Dia.	Overall Length	List
49340	1-3/8	1/2	1/4	2	\$ 67.89
49350	1-3/8	1/2	1/2	2-3/8	67.89

Replacement Bearings:  
 1/2 Rabbet 47702  
 7/16 Rabbet 47706

### **CORNER BEADING BITS - 2 Flute** With Ball-Bearing Guide

Particularly suitable for antique reproductions and restoration projects.

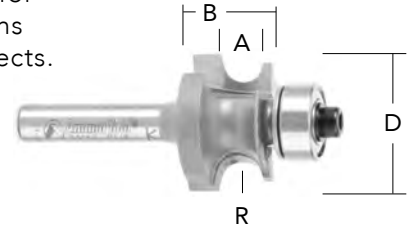

Tool No.	'R' Radius	'D' Large Dia.	'A' Opening	'B' Carbide Height	Shank Dia.	OA Length	List
54160	1/8	7/8	1/4	9/16	1/4	2-1/8	\$ 57.73
54164	3/16	1-1/8	3/8	11/16	1/4	2-1/4	65.11

Replacement bearing for 54160 use 47706.

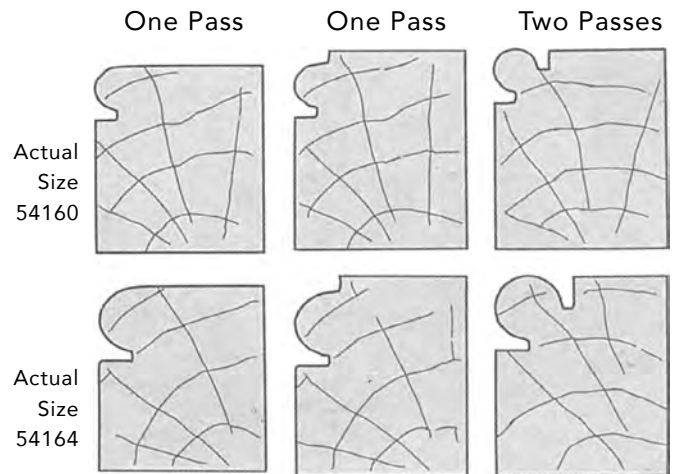

### **SPECIAL AMEROCK HINGE BITS - 2 Flute**

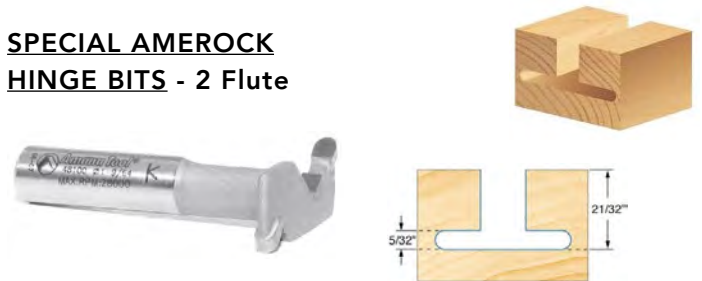

Tool No.	Cutting Dia.	Cutting Length	Shank Dia.	Overall Length	List
48100	1-1/8	21/32	3/8	2	\$ 49.49
48102	1-19/32	21/32	3/8	2	53.68

\* NOTE: These bits are not guaranteed due to extreme length.



## ROUTER BITS

## AMANA

### 3 WING SLOTING CUTTERS



<u>Tool No.</u>	<u>Kerf</u>	<u>Dia.</u>	<u>Bore</u>	<u>List</u>
53200	1/16	1-7/8	5/16	\$ 27.80
53202	5/64	1-7/8	5/16	27.80
53204	3/32	1-7/8	5/16	28.61
53210	1/4	1-7/8	5/16	32.81

### SLOTING CUTTER ASSEMBLIES

3 Wing  
1/2" Depth of Cut  
1/4" Shank,  
1-7/8" Diameter  
2-1/8" Overall Length

Replacement Arbors:  
1/4" shank - 47600  
1/2" shank - 47604



<u>Code</u>	<u>Kerf</u>	<u>List</u>
53400	1/16"	\$ 40.64
53402	5/64"	41.15
53406	1/8"	44.13
53407*	5/32"	45.24
53408	3/16"	45.24

**Note:** All above assemblies include cutter, arbor and ball-bearing and are ready to use.  
\*5/32 size also used for 'biscuit-joint' cutting.

### DOVETAIL BITS - 2 Flute



1/2"  
14°

<u>Tool No.</u>	<u>Degree</u>	<u>Cutting Dia.</u>	<u>Carbide Height</u>	<u>Shank Dia.</u>	<u>Overall Length</u>	<u>List</u>
45804	14°	1/2	1/2	1/4	1-3/4	\$ 30.53
45806	14°	1/2	1/2	1/2	2-3/8	34.32

### CORE BOX BITS - 2 Flute



<u>Tool No.</u>	<u>Radius</u>	<u>Cutting Dia.</u>	<u>Carbide Height</u>	<u>Shank Dia.</u>	<u>Overall Length</u>	<u>List</u>
45906	3/16	3/8	1/4	1/4	1-1/2	\$ 41.65
45910	1/4	1/2	3/8	1/4	1-1/2	42.66
45918	3/8	3/4	7/16	1/4	1-3/4	45.50
45920	3/8	3/4	7/16	1/2	2	60.81
45926	1/2	1	11/16	1/2	2-1/8	88.61

### OGEE FILLET - 2 Flute

With Ball-Bearing Guide  
(Max RPM 18 = 18,000)



<u>Tool No.</u>	<u>Dia.</u>	<u>Each Radius</u>	<u>Cutting Height</u>	<u>OA Length</u>	<u>Shank Dia.</u>	<u>List</u>
54110	1-3/8	5/32	1/2	2-1/16	1/4	\$ 93.92



# AMANA

# ROUTER BIT PARTS

## AMANA ROUTER BITS REPLACEMENT PARTS

### STEEL BALL BEARING GUIDES

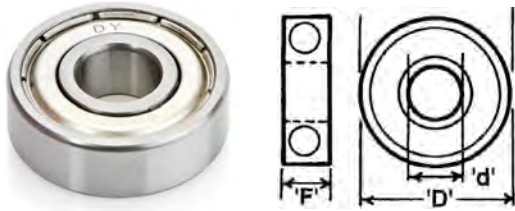

Amana uses only the finest **industrial quality precision ball-bearings** available. Bearings are double steel shielded for extra rigidity and to inhibit dust. A special high-performance, high-temperature grease is used for maximum life.

**Note:** Solvents should not be used to clean ball-bearings, as this will deteriorate the special grease. 'Frozen' bearings (ones that do not rotate freely), should be replaced immediately.

### FRACTIONAL - LISTED BY SIZE

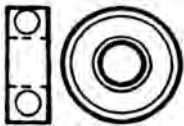

Tool No.	'd' Inside Dia.	'D' Out-side Dia.	'F' Face Width	Application	List
47723	1/8	1/4	.110(7/64)	47090, 47092 1/4" diameter trim bits	\$ 12.03
47702	3/16	3/8	.124(1/8)	3/8" diameter flush trim, all beading bits (49300/49302), 49340, 49350, 49540, 49542, 49550, many types of form bits	7.71
47706	3/16	1/2	.195(3/16)	Our most popular bearing. Fits 1/2" diameter flush trim, some bevel trim, all corner rounds, raised panel, rabbet, ovolo, many types of form bits, and 51570, 54160, 54162, 54198, 54370, 54200, 54220	6.39
47712	1/4	5/8	.195(3/16)	45462, 45476, 45478, 45479, 45809, 45811, 47180, 51530, 51532, 51534, 54188, 54190, 54192, 54194, 54296, 54324, 54350, 54352, 54354, 54356, 57100, 57106, 57112, "RC" series bevel trim bits	7.55